



# **Enabler Validation Plan for BCAST**

## **Candidate Version 1.0 – 28 Jan 2008**

---

**Open Mobile Alliance**  
OMA-EVP-BCAST-V1\_0-20080128-C

Use of this document is subject to all of the terms and conditions of the Use Agreement located at <http://www.openmobilealliance.org/UseAgreement.html>.

Unless this document is clearly designated as an approved specification, this document is a work in process, is not an approved Open Mobile Alliance™ specification, and is subject to revision or removal without notice.

You may use this document or any part of the document for internal or educational purposes only, provided you do not modify, edit or take out of context the information in this document in any manner. Information contained in this document may be used, at your sole risk, for any purposes. You may not use this document in any other manner without the prior written permission of the Open Mobile Alliance. The Open Mobile Alliance authorizes you to copy this document, provided that you retain all copyright and other proprietary notices contained in the original materials on any copies of the materials and that you comply strictly with these terms. This copyright permission does not constitute an endorsement of the products or services. The Open Mobile Alliance assumes no responsibility for errors or omissions in this document.

Each Open Mobile Alliance member has agreed to use reasonable endeavors to inform the Open Mobile Alliance in a timely manner of Essential IPR as it becomes aware that the Essential IPR is related to the prepared or published specification. However, the members do not have an obligation to conduct IPR searches. The declared Essential IPR is publicly available to members and non-members of the Open Mobile Alliance and may be found on the “OMA IPR Declarations” list at <http://www.openmobilealliance.org/ipr.html>. The Open Mobile Alliance has not conducted an independent IPR review of this document and the information contained herein, and makes no representations or warranties regarding third party IPR, including without limitation patents, copyrights or trade secret rights. This document may contain inventions for which you must obtain licenses from third parties before making, using or selling the inventions. Defined terms above are set forth in the schedule to the Open Mobile Alliance Application Form.

NO REPRESENTATIONS OR WARRANTIES (WHETHER EXPRESS OR IMPLIED) ARE MADE BY THE OPEN MOBILE ALLIANCE OR ANY OPEN MOBILE ALLIANCE MEMBER OR ITS AFFILIATES REGARDING ANY OF THE IPR'S REPRESENTED ON THE “OMA IPR DECLARATIONS” LIST, INCLUDING, BUT NOT LIMITED TO THE ACCURACY, COMPLETENESS, VALIDITY OR RELEVANCE OF THE INFORMATION OR WHETHER OR NOT SUCH RIGHTS ARE ESSENTIAL OR NON-ESSENTIAL.

THE OPEN MOBILE ALLIANCE IS NOT LIABLE FOR AND HEREBY DISCLAIMS ANY DIRECT, INDIRECT, PUNITIVE, SPECIAL, INCIDENTAL, CONSEQUENTIAL, OR EXEMPLARY DAMAGES ARISING OUT OF OR IN CONNECTION WITH THE USE OF DOCUMENTS AND THE INFORMATION CONTAINED IN THE DOCUMENTS.

© 2008 Open Mobile Alliance Ltd. All Rights Reserved.

Used with the permission of the Open Mobile Alliance Ltd. under the terms set forth above.

# Contents

<b>1</b>	<b>SCOPE</b> .....	<b>5</b>
1.1	<b>ASSUMPTIONS</b> .....	<b>5</b>
1.2	<b>EXCLUSIONS</b> .....	<b>5</b>
<b>2</b>	<b>REFERENCES</b> .....	<b>6</b>
2.1	<b>NORMATIVE REFERENCES</b> .....	<b>6</b>
2.2	<b>INFORMATIVE REFERENCES</b> .....	<b>6</b>
<b>3</b>	<b>TERMINOLOGY AND CONVENTIONS</b> .....	<b>8</b>
3.1	<b>CONVENTIONS</b> .....	<b>8</b>
3.2	<b>DEFINITIONS</b> .....	<b>8</b>
3.3	<b>ABBREVIATIONS</b> .....	<b>8</b>
<b>4</b>	<b>ENABLER VALIDATION DESCRIPTION</b> .....	<b>9</b>
<b>5</b>	<b>TESTFEST ACTIVITIES</b> .....	<b>10</b>
<b>5.1</b>	<b>ENABLER TEST GUIDELINES</b> .....	<b>10</b>
5.1.1	Minimal Test Configuration.....	10
5.1.2	Minimal Participation Guidelines.....	11
<b>5.2</b>	<b>ENABLER TEST REQUIREMENTS</b> .....	<b>12</b>
5.2.1	Test Infrastructure Requirements.....	12
5.2.2	Test Restrictions.....	13
5.2.3	Service Guide Related Flows.....	14
5.2.4	File Distribution Related Flows.....	17
5.2.5	Stream Distribution Related Flows.....	20
5.2.6	Service & Content Protection Related Flows.....	22
5.2.7	Interaction Channel Related Flows.....	24
5.2.8	Service Provisioning Related Flows.....	25
5.2.9	Notification Function Related Flows.....	29
5.2.10	Terminal Provisioning Related Flows.....	32
5.2.11	Test Content Requirements.....	32
5.2.12	Test Limitations.....	33
5.2.13	Test Restrictions.....	33
5.2.14	Test Tools.....	33
5.2.15	Resources Required.....	35
<b>5.3</b>	<b>TESTS TO BE PERFORMED</b> .....	<b>36</b>
5.3.1	Minimal Pre-Test Guidelines.....	36
5.3.2	Pre testing to be performed at the TestFest.....	38
5.3.3	Testing to be Performed at TestFest.....	38
<b>5.4</b>	<b>ENABLER TEST REPORTING</b> .....	<b>38</b>
5.4.1	Problem Reporting Requirements.....	38
5.4.2	Enabler Test Requirements.....	38
<b>6</b>	<b>ALTERNATIVE VALIDATION ACTIVITIES</b> .....	<b>39</b>
<b>7</b>	<b>APPROVAL CRITERIA</b> .....	<b>40</b>
<b>APPENDIX A.</b>	<b>CHANGE HISTORY (INFORMATIVE)</b> .....	<b>41</b>
<b>A.1</b>	<b>APPROVED VERSION HISTORY</b> .....	<b>41</b>
<b>A.2</b>	<b>DRAFT/CANDIDATE VERSION 1.0 HISTORY</b> .....	<b>41</b>

# Tables

Table 1: Priority of Tests to be Performed at TestFest ..... 12

Table 2: Conformance Test Case Priorities..... 34

# 1 Scope

This document details the Validation plan for the BCAST 1.0 Enabler Release. The successful accomplishment of the validation activities will be required for the Enabler to be considered for Approved status.

The validation plan for the BCAST 1.0 Enabler Release specifications is based on testing expectations in the Enabler Test Requirements (ETR). While the specific test activities to be performed are described in the Enabler Test Specification (ETS) the test environment is described in this plan. This test environment details infrastructure, operational and participation requirements identified for the needed testing activities.

## 1.1 Assumptions

None

## 1.2 Exclusions

None

## 2 References

### 2.1 Normative References

[BCAST10 –MBMS Adaptation]	"Broadcast Distribution System Adaptation – 3GPP/MBMS", Open Mobile Alliance™, OMA-TS-BCAST_MBMS_Adaptation-V1_0, <a href="http://www.openmobilealliance.org/">http://www.openmobilealliance.org/</a>
[BCAST10 – Distribution]	"File and Stream Distribution for Mobile Broadcast Services ", Open Mobile Alliance™, OMA-TS-BCAST_Distribution-V1_0, <a href="http://www.openmobilealliance.org/">http://www.openmobilealliance.org/</a>
[BCAST10 –ESG]	"Service and Content Protection for Mobile Broadcast Services", Open Mobile Alliance™, OMA-TS-BCAST_SvcCntProtection-V1_0, <a href="http://www.openmobilealliance.org">http://www.openmobilealliance.org</a>
[BCAST10 -Services]	"Mobile Broadcast Services", Open Mobile Alliance™, OMA-TS-BCAST_Services-V1_0, <a href="http://www.openmobilealliance.org/">http://www.openmobilealliance.org/</a>
[BCAST10–BCMCS Adaptation]	"Broadcast Distribution System Adaptation – 3GPP2/BCMCS", Open Mobile Alliance™, OMA-TS-BCAST_BCMCS_Adaptation-V1_0, <a href="http://www.openmobilealliance.org/">http://www.openmobilealliance.org/</a>
[BCAST10–DVB-H-IPDC–Adaptation]	"Broadcast Distribution System Adaptation – IPDC over DVB-H", Open Mobile Alliance™, OMA-TS-BCAST_DVB_Adaptation-V1_0, <a href="http://www.openmobilealliance.org/">http://www.openmobilealliance.org/</a>
[BCAST10-ERELED]	"Enabler Release Definition for Mobile Broadcast Services", Open Mobile Alliance™, OMA-ERELED-BCAST-V1_0, <a href="http://www.openmobilealliance.org/">http://www.openmobilealliance.org/</a>
[BCAST10-ETR]	"Enabler Test Requirements for Mobile Broadcast Services" Open Mobile Alliance™, OMA-ETR-BCAST-V1_0, <a href="http://www.openmobilealliance.org/">http://www.openmobilealliance.org/</a>
[BCAST10– ServContProt]	"Service and Content Protection for Mobile Broadcast Services", Open Mobile Alliance™, OMA-TS-BCAST_SvcCntProtection-V1_0, <a href="http://www.openmobilealliance.org/">http://www.openmobilealliance.org/</a>
[DRM20-Broadcast-Extensions]	"OMA DRM v2.0 Extensions for Broadcast Support", Open Mobile Alliance™, OMA-TS-DRM-XBS-V1_0, <a href="http://www.openmobilealliance.org/">http://www.openmobilealliance.org/</a>
[DRM-v2.0]	"DRM Specification V2.0", Open Mobile Alliance™, OMA-DRM-DRM-V2_0, <a href="http://www.openmobilealliance.org/">http://www.openmobilealliance.org/</a>
[IOPPROC]	"OMA Interoperability Policy and Process", Version 1.5, Open Mobile Alliance™, OMA-ORG-IOP_Process-V1_5, URL: <a href="http://www.openmobilealliance.org/">http://www.openmobilealliance.org/</a>
[IOPTFG]	"OMA TestFest Participation Guidelines", Version 1.2, Open Mobile Alliance™, OMA-IOP-TestFest-Participation-Guidelines-V1_2, URL: <a href="http://www.openmobilealliance.org/">http://www.openmobilealliance.org/</a>
[OMA DM]	"Enabler Release Definition for OMA Device Management v1.2", OMA-ERELED-DM-V1_2_0, <a href="http://www.openmobilealliance.org/">http://www.openmobilealliance.org/</a>
[RFC2119]	"Key words for use in RFCs to Indicate Requirement Levels", S. Bradner, March 1997, URL: <a href="http://www.ietf.org/rfc/rfc2119.txt">http://www.ietf.org/rfc/rfc2119.txt</a>

### 2.2 Informative References

[BCAST10- Architecture]	"Mobile Broadcast Services Architecture", Open Mobile Alliance™, OMA-AD- BCAST-V1_0, <a href="http://www.openmobilealliance.org/">http://www.openmobilealliance.org/</a>
[BCAST10-EICS-Client]	"Client Enabler Implementation Conformance Statement", Open Mobile Alliance™, OMA-EICS-BCAST_Client-V1_0, <a href="http://www.openmobilealliance.org/">http://www.openmobilealliance.org/</a>
[BCAST10-EICS-	"Server Enabler Implementation Conformance Statement", Open Mobile Alliance™, OMA-

---

<b>Server]</b>	EICS-BCAST_Server-V1_0, <a href="http://www.openmobilealliance.org/">http://www.openmobilealliance.org/</a>
<b>[BCAST10-ETS-Client]</b>	"Client Conformance Enabler Test Specification for BCAST 1.0", Open Mobile Alliance™, OMA-ETS-BCAST_CON_Client-V1.0, <a href="http://www.openmobilealliance.org/">http://www.openmobilealliance.org/</a>
<b>[BCAST10-ETS-IOP]</b>	"Interoperability Enabler Test Specification for BCAST 1.0", Open Mobile Alliance™, OMA-ETS-BCAST_IOP-V1.0, <a href="http://www.openmobilealliance.org/">http://www.openmobilealliance.org/</a>
<b>[BCAST10-ETS-Server]</b>	"Server Conformance Enabler Test Specification for BCAST 1.0", Open Mobile Alliance™, OMA-ETS-BCAST_CON_Server-V1.0, <a href="http://www.openmobilealliance.org/">http://www.openmobilealliance.org/</a>
<b>[OMADICT]</b>	"Dictionary for OMA Specifications", Open Mobile Alliance™, OMA-Dictionary, URL: <a href="http://www.openmobilealliance.org/">http://www.openmobilealliance.org/</a>

## 3 Terminology and Conventions

### 3.1 Conventions

The key words “MUST”, “MUST NOT”, “REQUIRED”, “SHALL”, “SHALL NOT”, “SHOULD”, “SHOULD NOT”, “RECOMMENDED”, “MAY”, and “OPTIONAL” in this document are to be interpreted as described in [RFC2119].

All sections and appendixes, except “Scope”, are normative, unless they are explicitly indicated to be informative.

### 3.2 Definitions

<b>Application</b>	A value-added data service provided to a Client. The application may utilise BCAST and/or other ways of data transfer to deliver content
<b>Bearer Network</b>	A network used to carry the messages of a transport-layer protocol between physical devices. Multiple bearer networks may be used over the life of a single push session.
<b>Client</b>	A client is a device or service that expects to receive BCAST content from a server.
<b>Content</b>	Subject matter (data) stored or generated at an origin server. Content is typically displayed or interpreted by a user agent on a client.
<b>Device</b>	Is a network entity that is capable of sending and/or receiving packets of information and has a unique device address. A device can act as either a client or a server within a given context or across multiple contexts. For example, a device can service a number of clients (as a server) while being a client to another server.
<b>End-user</b>	See "user"
<b>Server</b>	A device (or service) which accepts or rejects a connection request from a client. A server may initiate a connection to a client or many clients as part of a service.
<b>User</b>	A user is a person who interacts with a user agent to view, hear, or otherwise use a rendered content. Also referred to as end-user.
<b>User agent</b>	A user agent (or content interpreter) is any software or device that interprets resources. This may include multimedia players, news tickers, etc.

### 3.3 Abbreviations

<b>BDS</b>	Broadcast Distribution System
<b>ETR</b>	Enabler Test Requirements
<b>ETS</b>	Enabler Test Specification
<b>GPRS</b>	General Packet Radio Service
<b>HTTP</b>	Hypertext Transfer Protocol
<b>IP</b>	Internet Protocol
<b>MS</b>	Mobile Station
<b>MSISDN</b>	Mobile Station International Subscriber Directory Number
<b>OMA</b>	Open Mobile Alliance
<b>QoS</b>	Quality of Service
<b>RFC</b>	Request For Comments
<b>TCP</b>	Transmission Control Protocol
<b>UDP</b>	User Datagram Protocol
<b>URI</b>	Uniform Resource Identifier
<b>URL</b>	Uniform Resource Locator



## 4 Enabler Validation Description

A full description of BCAST 1.0 can be found in the BCAST10-ERELED, ETR, TS and other documents mentioned in the references. For details see chapter 5.

## 5 TestFest Activities

### 5.1 Enabler Test Guidelines

#### 5.1.1 Minimal Test Configuration

The tests will be done with servers and matching clients i.e. testing a MBMS server against IPDC clients will not be planned.

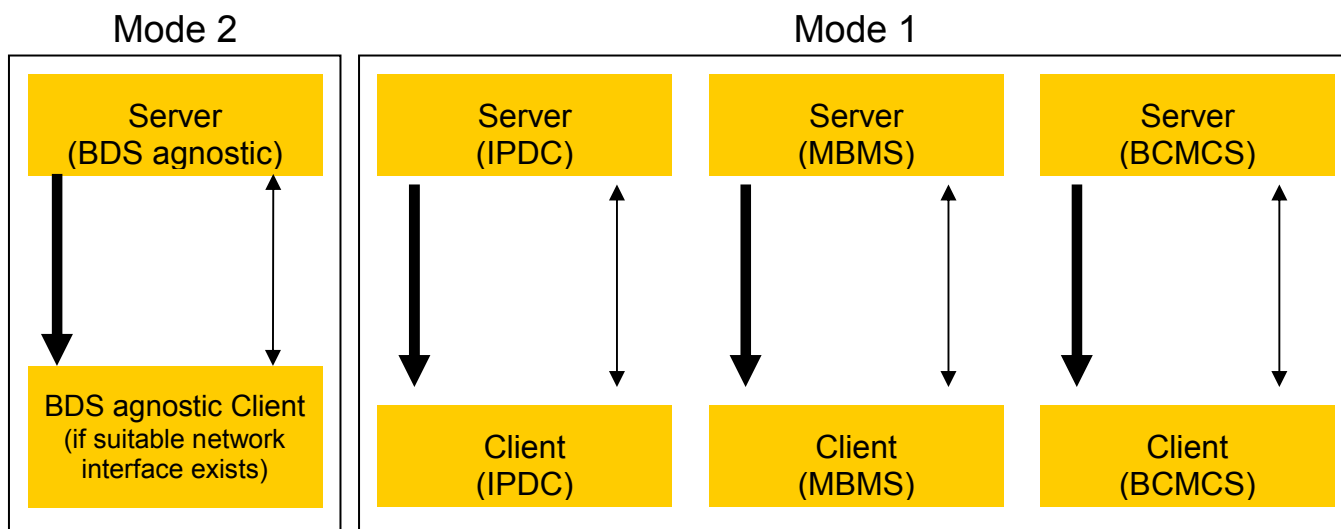

In order to minimize the number of test cases the tests will be defined in four sets (BDS agnostic, IPDC, MBMS and BCMCS) so that the BDS agnostic parts don't need to be tested four times.

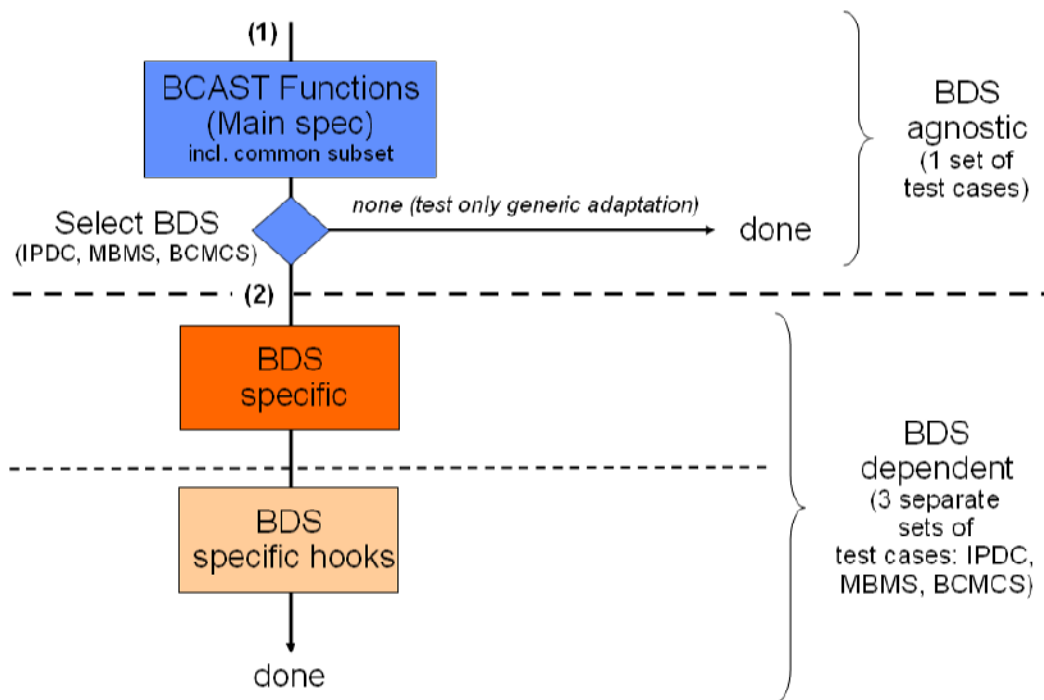

BDS specific tests can start at (2) if the BDS agnostic tests (between 1 and 2) have been passed.

## 5.1.2 Minimal Participation Guidelines

Minimum

- three client implementations

and

- three BCAST servers

are needed.

The clients and the servers have to match. Having e.g. one IPDC client, one MBMS client and one MBMS server is not sufficient.

In case a test fest is desirable to happen with less servers or clients such requests will be handled as exceptions. Privacy regarding test results could be handled in that way that test results are not published. Details will be negotiated with the test event organizer and the participants. Such exceptions have happened at test fests before.

## 5.1.3 Optimal TestFest Achievement Guidelines

The TestFest participants are expected to do as much testing as possible during the dedicated test slot. Full list of interoperability test cases can be found from the BCAST Interoperability Enabler Test Specification [BCAST10-ETS\_IOP]. The list of test cases executed during a TestFest may vary depending on the special characteristics of the test environment (e.g. the used BDS or the available content protection methods).

In case there is a need to prioritize testing during the TestFest, due time constraints or otherwise, the following prioritization should be used as described in Table 1.

Test Case Id	Priority
5.1.1 Service bootstrap and single content	High (pre-test)
5.2.1 Service Guide update (same fragment id, higher version number)	High
5.2.5 GZIP compression of Service Guide Delivery Unit	High (pre-test)
5.2.6 Content hierarchy	High
5.2.5 PreviewData and Service	High
5.2.9 Select language specific access parameters	High
5.2.10 Subscription of Service	High
5.5.2.1.1 GBA-U Bootstrapping USIM / BSM with success	High (pre-test)
5.5.2.1.5 Deregistration	High
5.5.2.2.1 LTKM (without EXT BCAST: MBMS like) reception at the smartcard	High
5.5.2.2.2 LTKM request from the terminal, LTKM reception at the terminal / smartcard	High
5.5.2.2.3 BSM solicited pull procedure	High
5.5.2.3.1 Correct STKM parsing by Smartcard	High (pre-test)
5.5.2.3.2 Correct STKM parsing by Smartcard (MBMS)	High
5.5.2.3.3 Incorrect STKM generation – inexistent SEK/PEK (wrong domain ID)	High
5.5.2.3.4 STKM processing – inexistent SEK/PEK (wrong SEK ID)	High
5.5.2.3.5 LTKM with invalid validity data	High
5.5.2.3.7 Key deletion from server	High
5.5.2.3.8.6 Replay STKM reception : precondition 6: Security_policy_extension in LTKM : 0x04; pass criteria: error	High
5.5.2.3.9 STKM reception with same same cryptoperiod – terminal filtering	High

Test Case Id	Priority
5.5.2.3.12 Multiple streams protected with same STKM stream	High
5.5.2.3.13 Multiple streams protected with Different STKM stream	High
5.5.2.4.3 Delivery of ISMACrypt protected stream	High
5.3.1.2 Support of in-band delivery of meta-data and FLUTE	Medium
5.4.1 XHTML MP Interactivity	Medium
5.4.3 SMS interactivity	Medium
5.4.5 MMS Interactivity	Medium
5.5.2.1.6 Deregistration with bootstrapping	Medium
5.5.2.2.4 BSM solicited pull procedure initiation over SMS bearer	Medium
5.5.2.4.1 Delivery of IPSec protected stream	Low
5.5.2.4.2 Delivery of SRTP protected stream	Low
5.5.2.1.2 GBA-U Bootstrapping USIM / BSM with synchronization error	Low
5.5.2.1.3 GBA_U: Expired Bootstrapping data	Low
5.5.2.1.4 GBA_U: Different Key K on Client and Server	Low
5.5.2.3.8.7 Replay STKM reception : precondition 7: Security_policy_extension in LTKM : 0x05; pass criteria: error	Low
5.5.2.3.10 STKM reception with parental control without PIN defined in the card	Low
5.6.1 Receiving terminal provisioning messages using TP-7	Low
5.6.2 Update terminal provisioning messages using TP-7	Low
5.6.3 Declaring Terminal Provisioning as a Service within Service Guide	Low
5.6.4 Declaring Terminal Provisioning as an Access of a Service within Service Guide	Low

**Table 1: Priority of Tests to be Performed at TestFest**

The following tests are not applicable for the January test fest if the service protection and content protection technical specification dated 07 November 2007 is referred for the tests. These tests need to be updated:

5.5.2.2.5 (BCAST-1.0-DIST-int-415); 5.5.2.2.5.1 (BCAST-1.0-DIST-int-416); 5.5.2.2.5.2 (BCAST-1.0-DIST-int-417); 5.5.2.2.5.3 (BCAST-1.0-DIST-int-418); 5.5.2.2.5.4 (BCAST-1.0-DIST-int-419); 5.5.2.2.5.5 (BCAST-1.0-DIST-int-420); 5.5.2.2.5.6 (BCAST-1.0-DIST-int-421); 5.5.2.2.5.7 (BCAST-1.0-DIST-int-422); 5.5.2.2.5.8 (BCAST-1.0-DIST-int-423); 5.5.2.2.5.9 (BCAST-1.0-DIST-int-424); 5.5.2.2.5.10 (BCAST-1.0-DIST-int-425); 5.5.2.2.5.11 (BCAST-1.0-DIST-int-426); 5.5.2.2.5.12 (BCAST-1.0-DIST-int-427); 5.5.2.2.5.13 (BCAST-1.0-DIST-int-428); 5.5.2.2.5.14 (BCAST-1.0-DIST-int-429); 5.5.2.3.6 (BCAST-1.0-DIST-int-435); 5.5.2.3.6.1 (BCAST-1.0-DIST-int-436); 5.5.2.3.6.2 (BCAST-1.0-DIST-int-437); 5.5.2.3.6.3 (BCAST-1.0-DIST-int-438); 5.5.2.3.8.1 (BCAST-1.0-DIST-int-440); 5.5.2.3.8.2 (BCAST-1.0-DIST-int-441); 5.5.2.3.8.3 (BCAST-1.0-DIST-int-442); 5.5.2.3.8.4 (BCAST-1.0-DIST-int-443); 5.5.2.3.8.5 (BCAST-1.0-DIST-int-444); 5.5.2.3.8.8 (BCAST-1.0-DIST-int-447); 5.5.2.3.8.9 (BCAST-1.0-DIST-int-448); 5.5.2.3.8.10 (BCAST-1.0-DIST-int-449); 5.5.2.3.8.11 (BCAST-1.0-DIST-int-450); 5.5.2.3.8.12 (BCAST-1.0-DIST-int-451); 5.5.2.3.8.13 (BCAST-1.0-DIST-int-452); 5.5.2.3.8.14 (BCAST-1.0-DIST-int-453); 5.5.2.3.8.15 (BCAST-1.0-DIST-int-454); 5.5.2.3.11 (BCAST-1.0-DIST-int-457);

## 5.2 Enabler Test Requirements

### 5.2.1 Test Infrastructure Requirements

The testing shall be performed as end-to-end testing. Most likely the client participants will be in one place, while the participant servers will be located in member companies premises, accessible to the rest of the test fest environment. Such a “distributed” test fest environment puts effort on the test fest host and requires detailed documented configuration. It is also possible that server providers bring their respective servers to the test site.

The Network Elements involved in BCAST testing are:

- 3G network
- MBMS network
- DVB-H network
- BCMCS
- Internet

A Network Analyzer (e.g. Wireshark) for Network Monitoring/Protocol Analyzing is also useful.

A requirement for a test host is that one BDS must be available. At least one of the following BDS:

- IPDC
- MBMS
- BCMCS

## 5.2.2 Test Restrictions

For the different services that comprise BCAST it can be found below the different execution flows.

## 5.2.3 Service Guide Related Flows

### 5.2.3.1 Service Guide Generation and Delivery over Broadcast channel

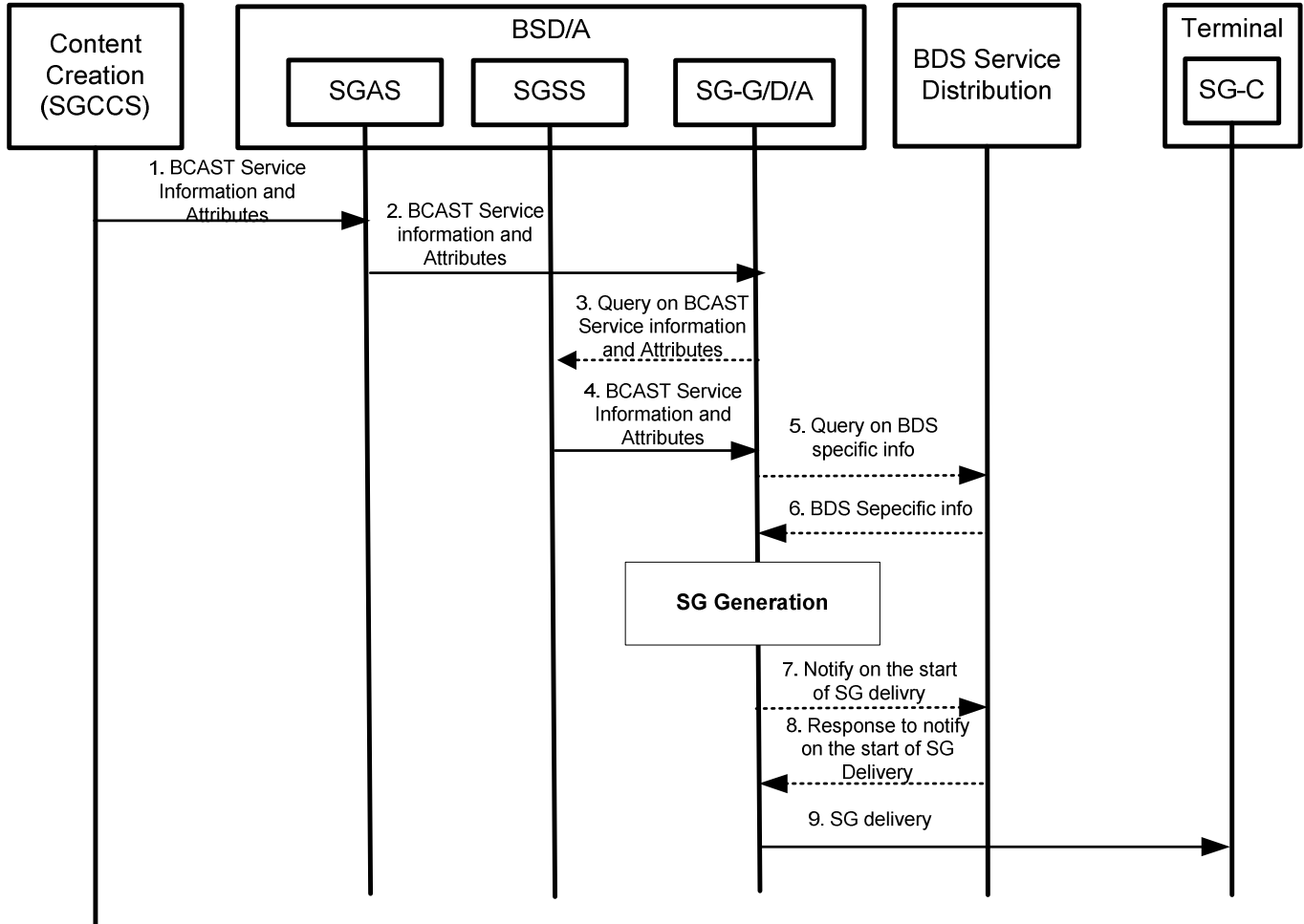

### 5.2.3.2 Service Guide Generation and Delivery over Interaction channel

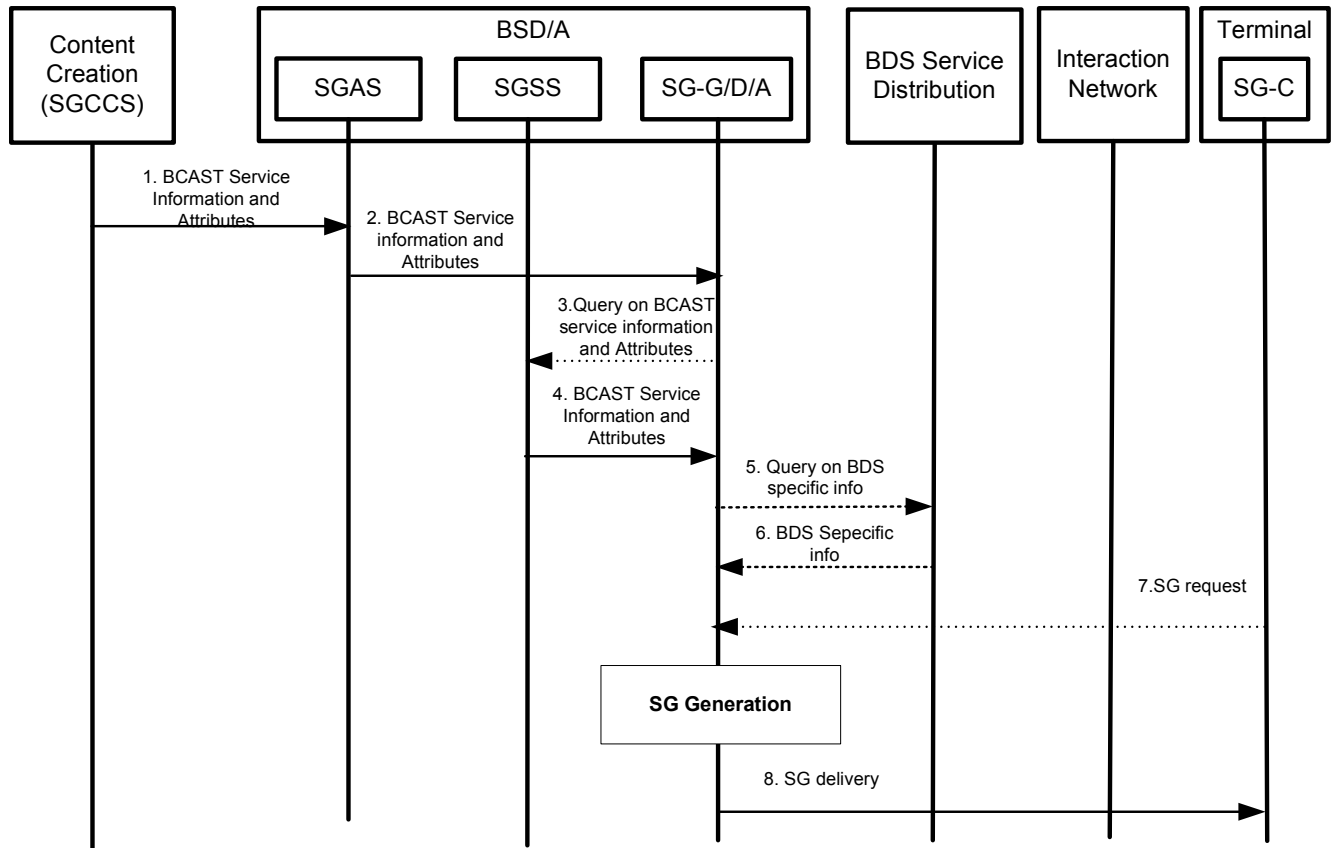

### 5.2.3.3 Service Guide Delivery to BDS Service Distribution

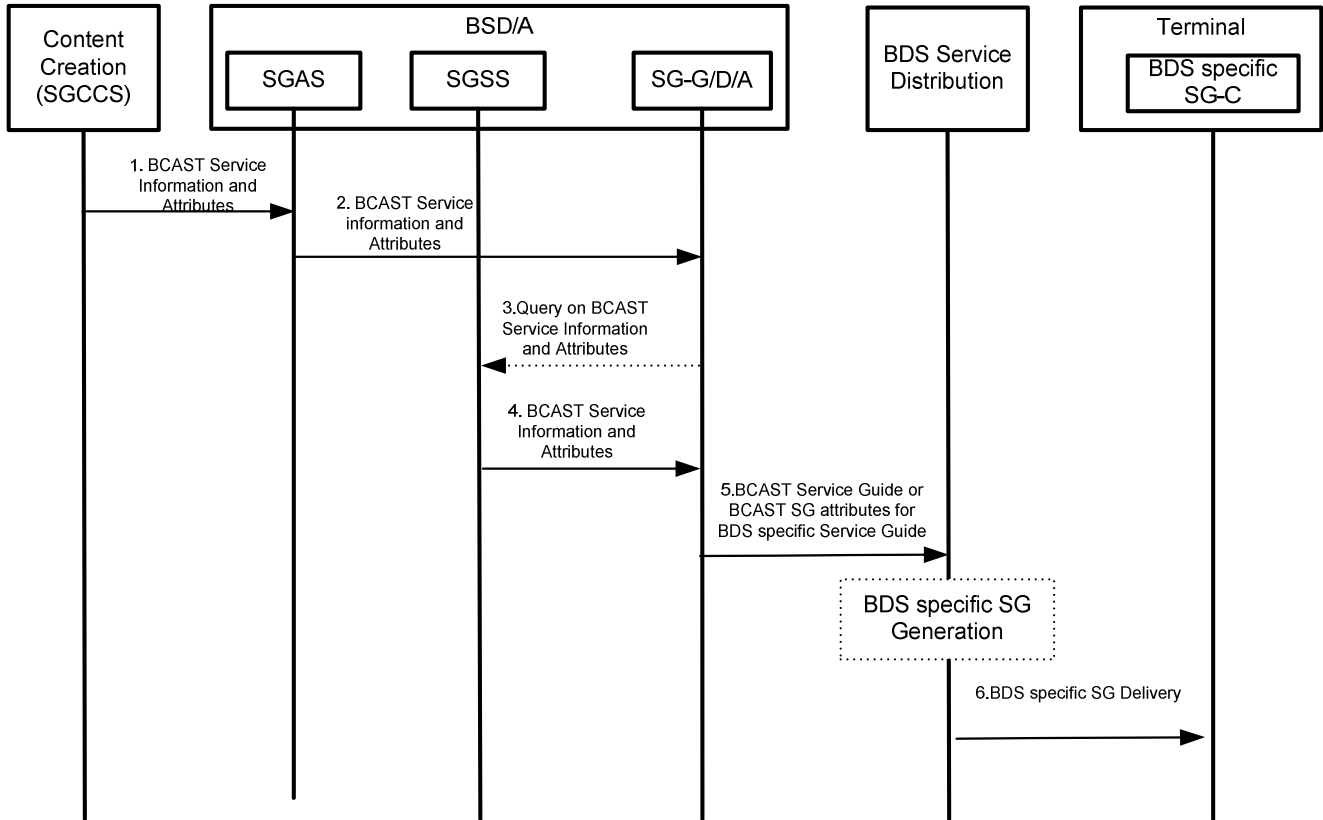



## 5.2.4 File Distribution Related Flows

### 5.2.4.1 File Distribution over Broadcast channel

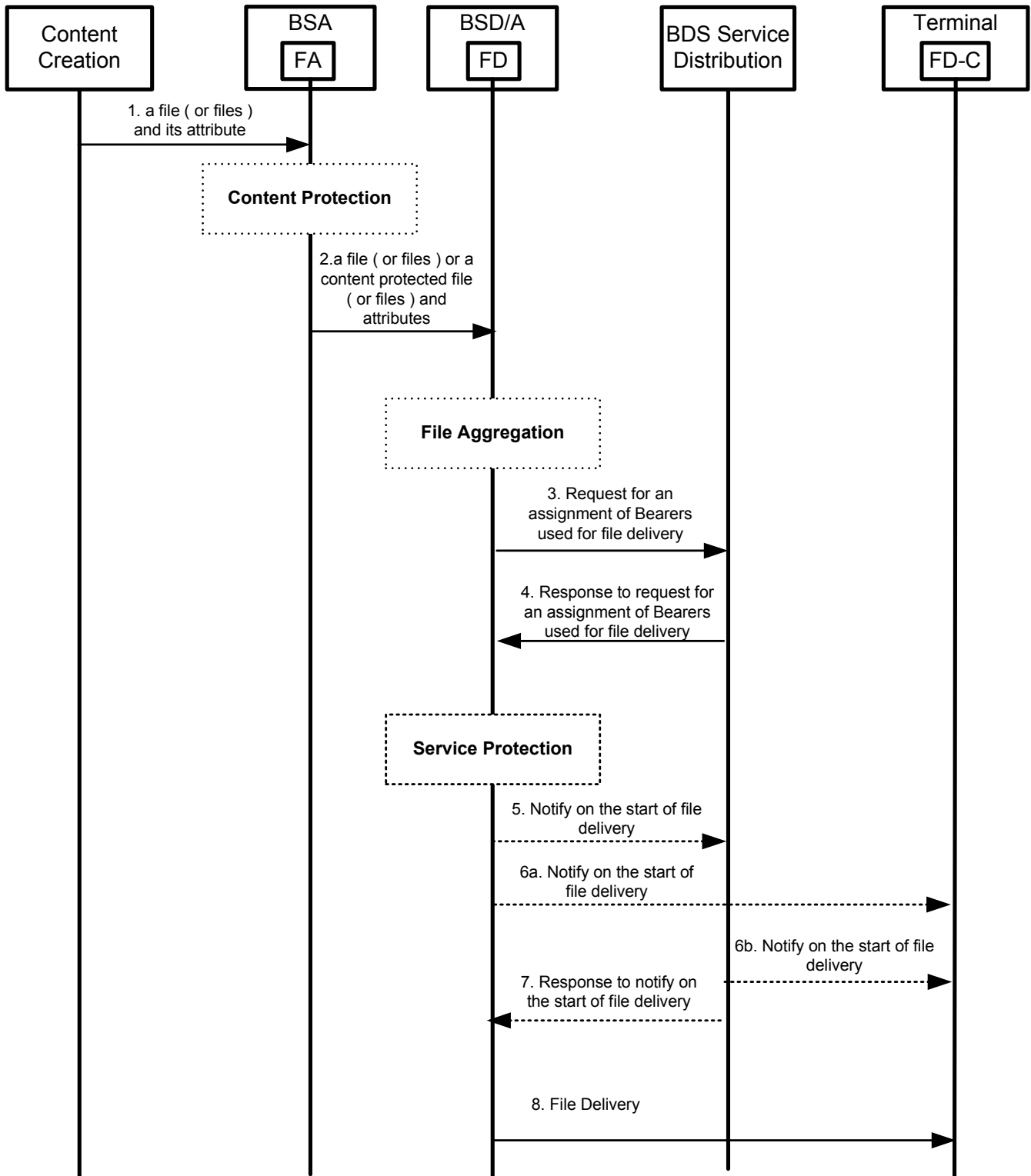

### 5.2.4.2 File transmission or repairing over Interaction Channel when BDS Service Distribution exists

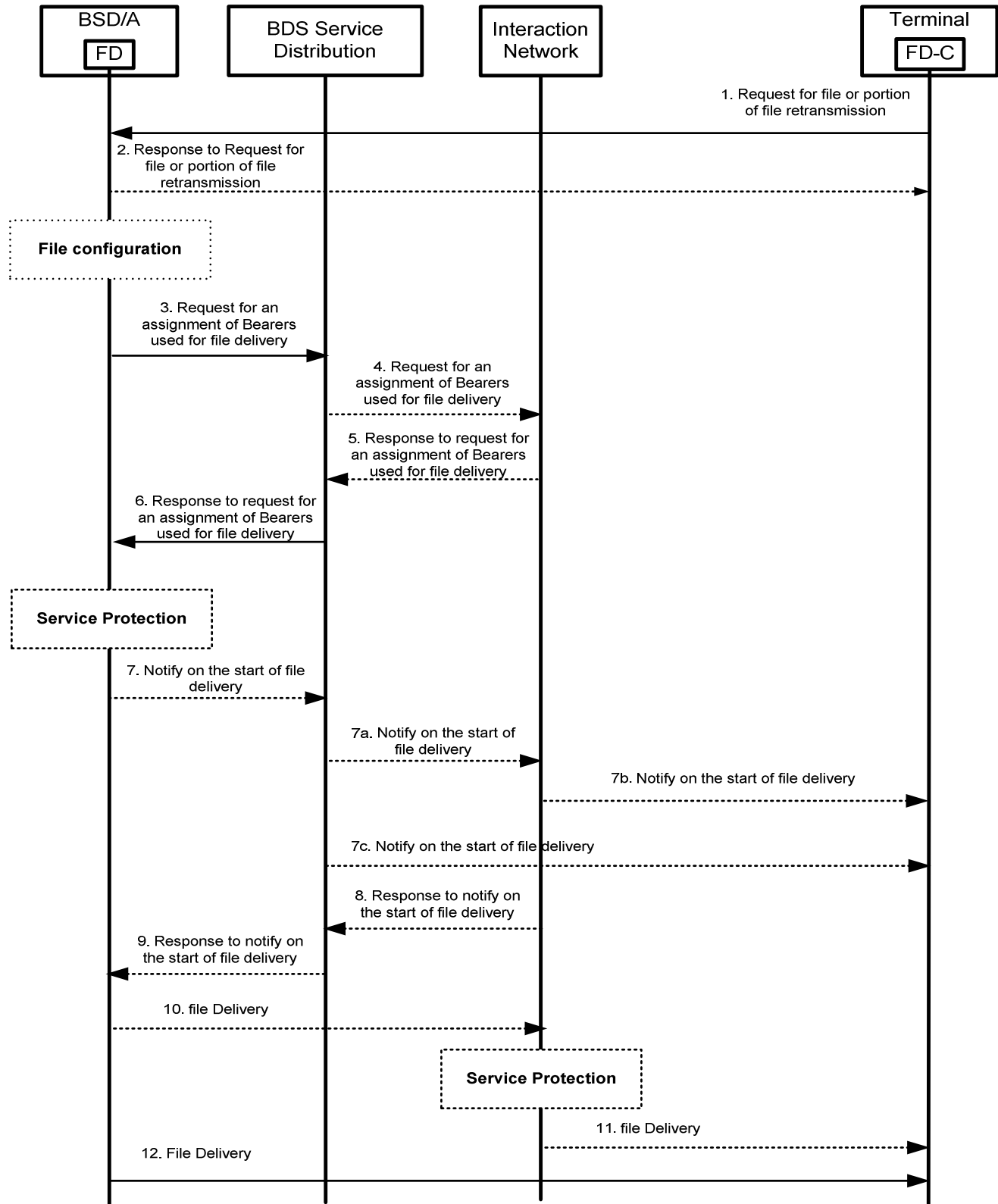

### 5.2.4.3 File Delivery to BDS Service Distribution

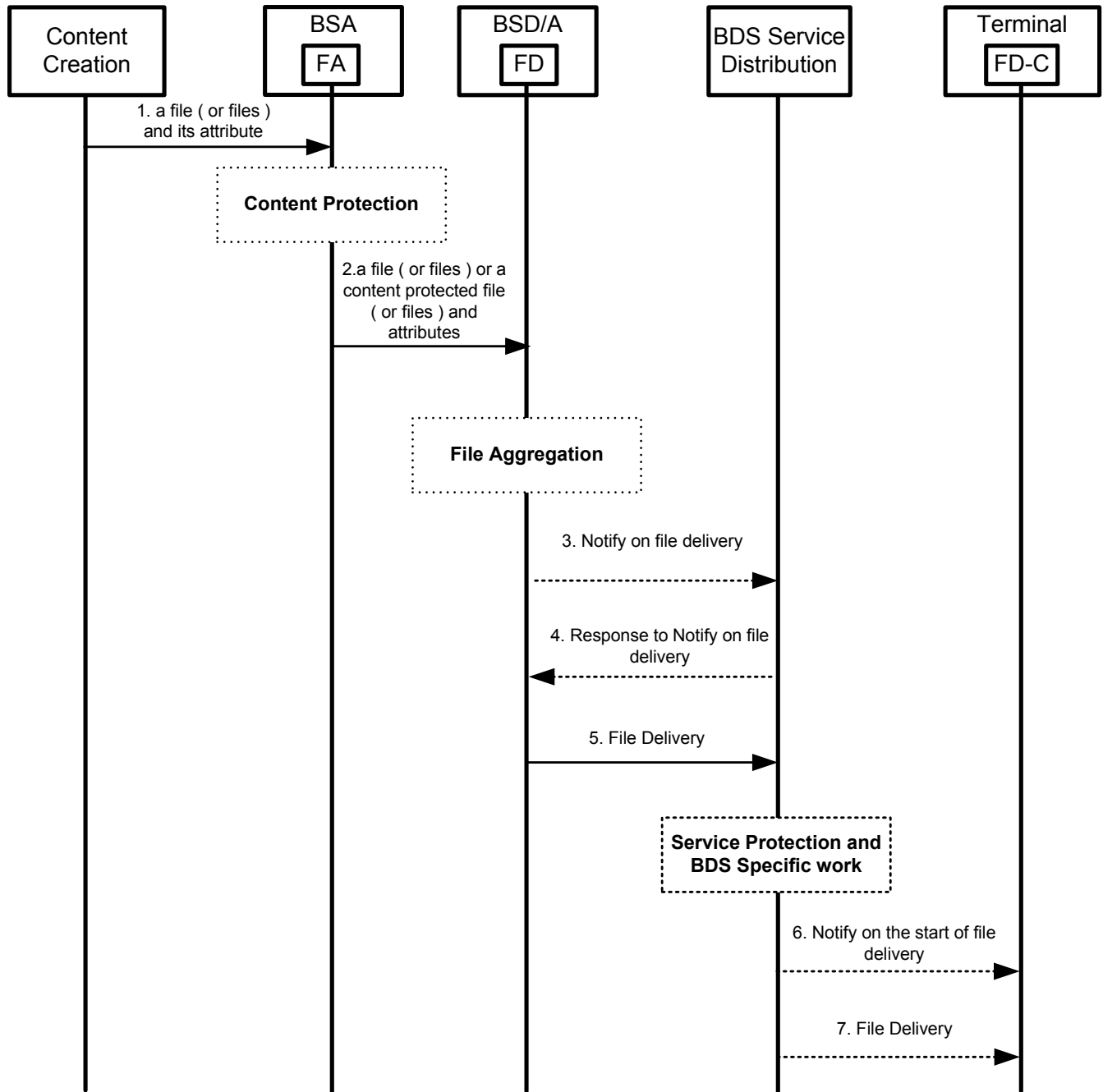

## 5.2.5 Stream Distribution Related Flows

### 5.2.5.1 Stream Distribution over Broadcast channel

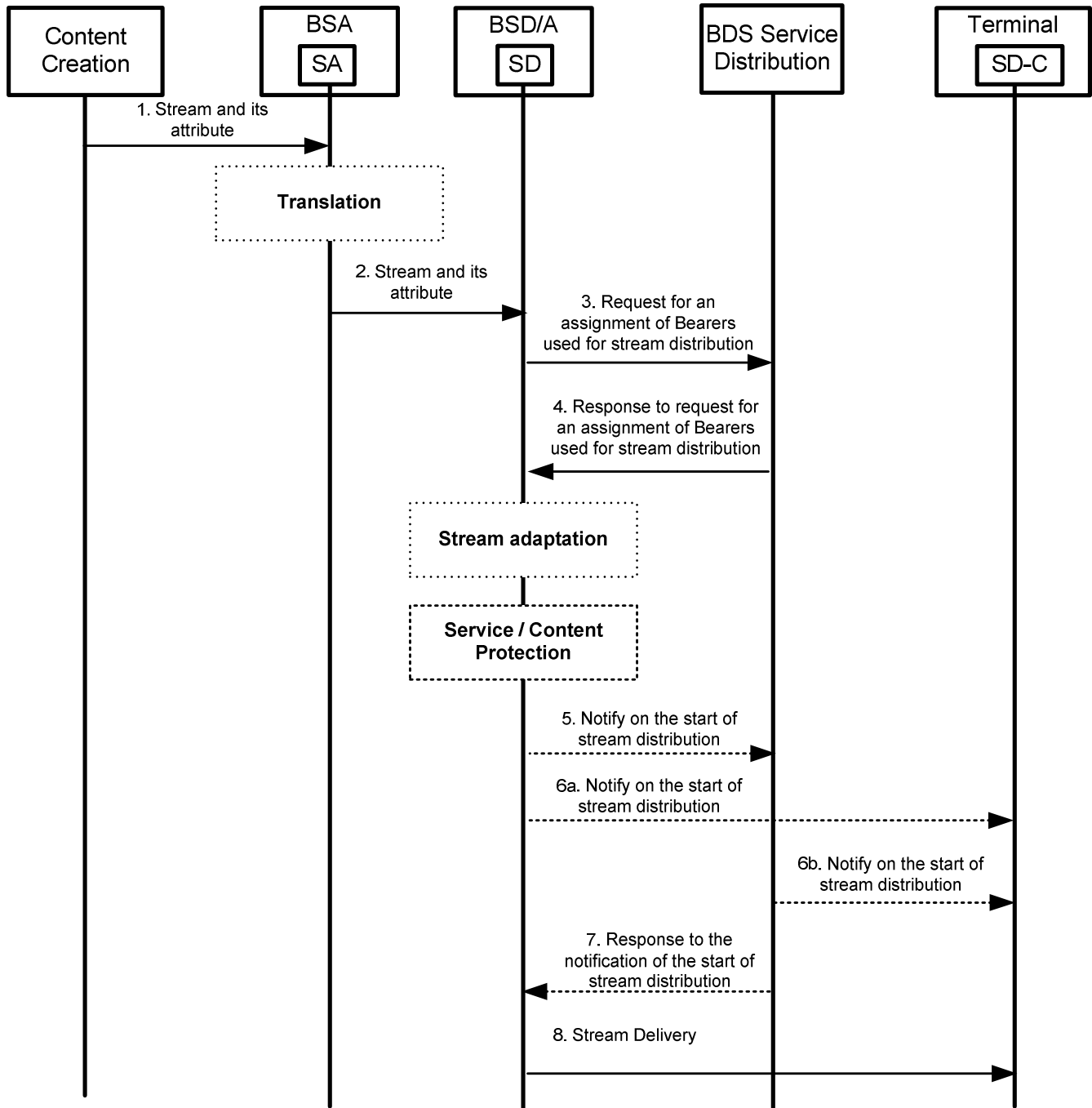

### 5.2.5.2 Stream Delivery BDS Service Distribution

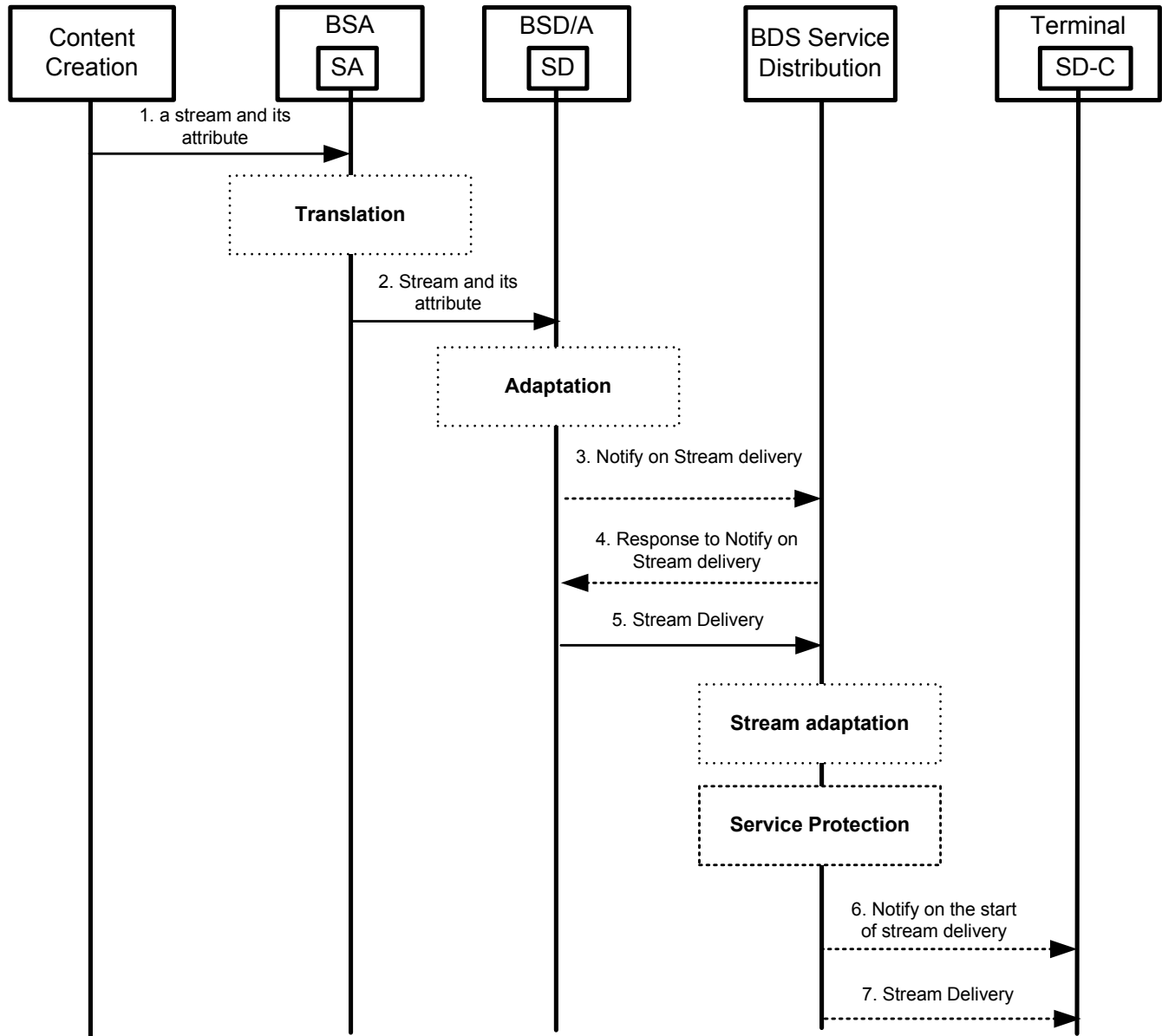

## 5.2.6 Service & Content Protection Related Flows

### 5.2.6.1 Service Protection Related Flows

#### 5.2.6.1.1 Service Protection Function Flows for Terminal with Interaction Channel

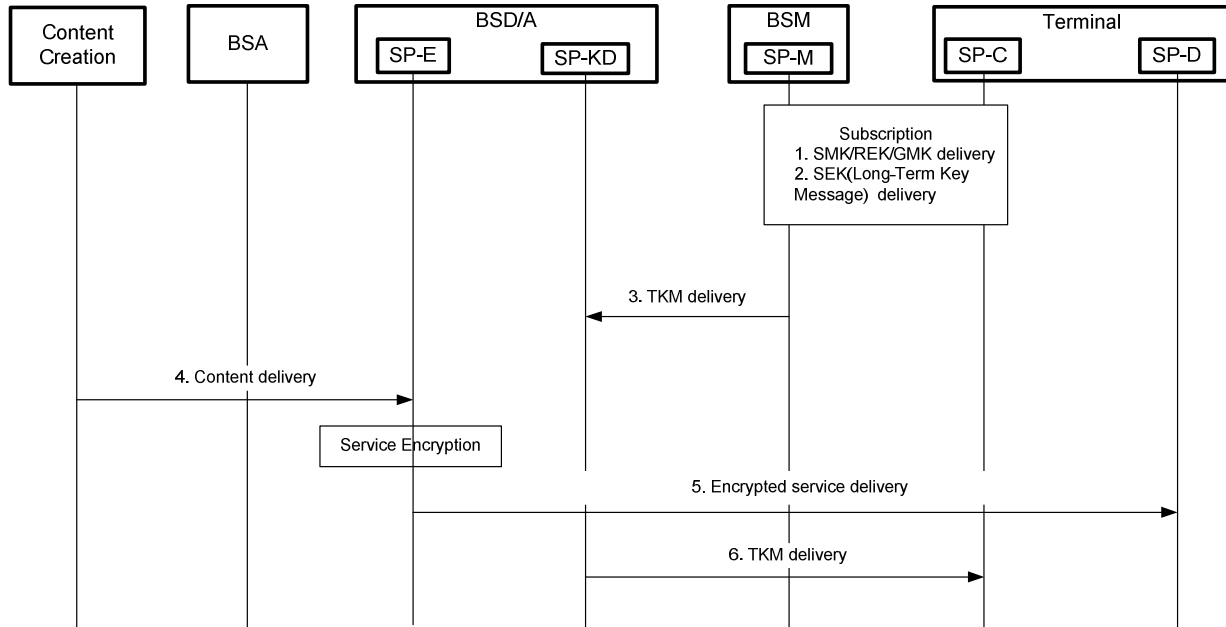

#### 5.2.6.1.2 Service Protection Function Flows for Broadcast-only Terminal

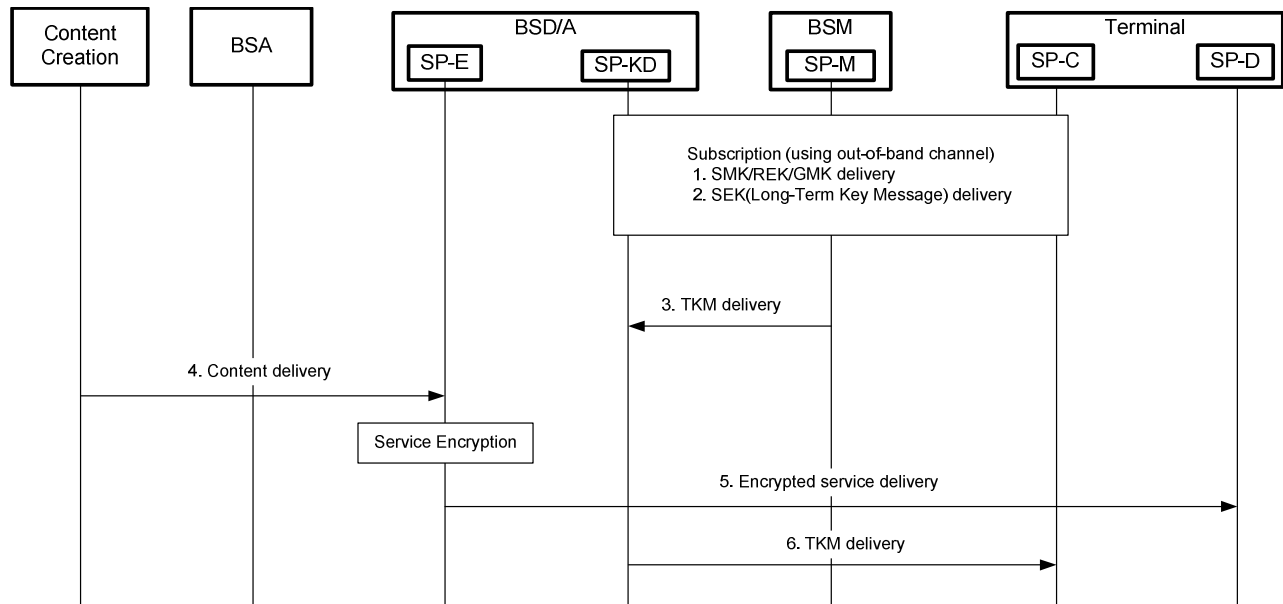

### 5.2.6.2 Content Protection Function Flows

#### 5.2.6.2.1 Content Protection Function Flows for Terminal with Interaction Channel

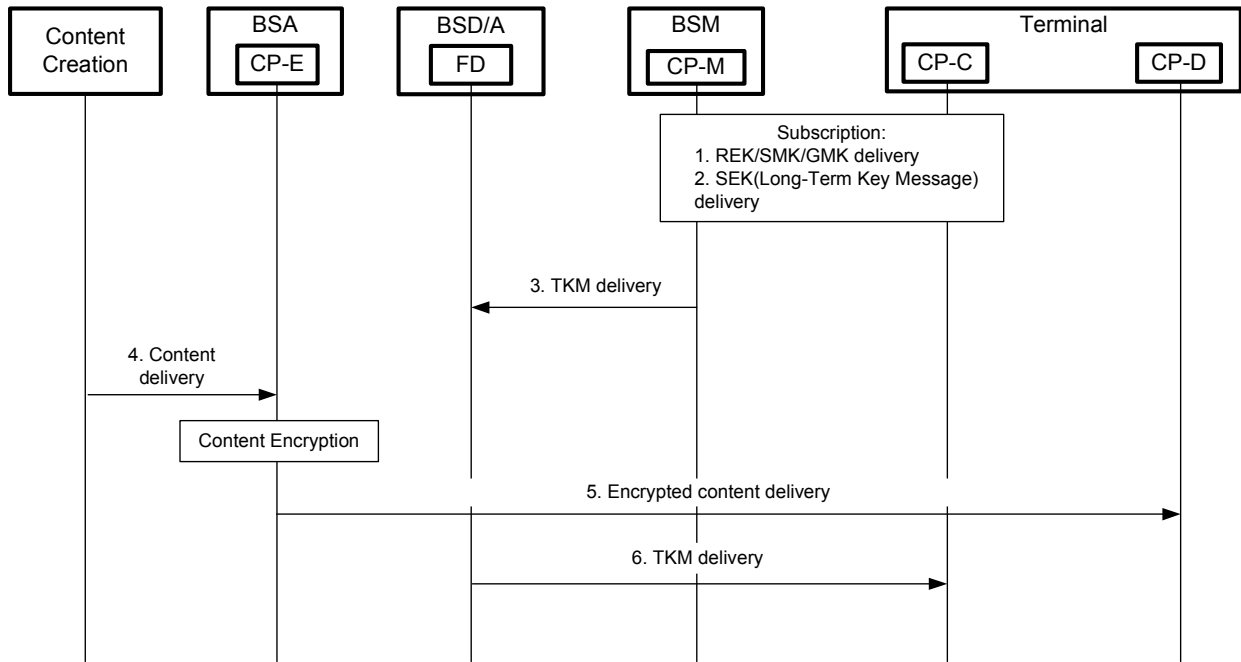

#### 5.2.6.2.2 Content Protection Function Flows for Broadcast-only Terminal

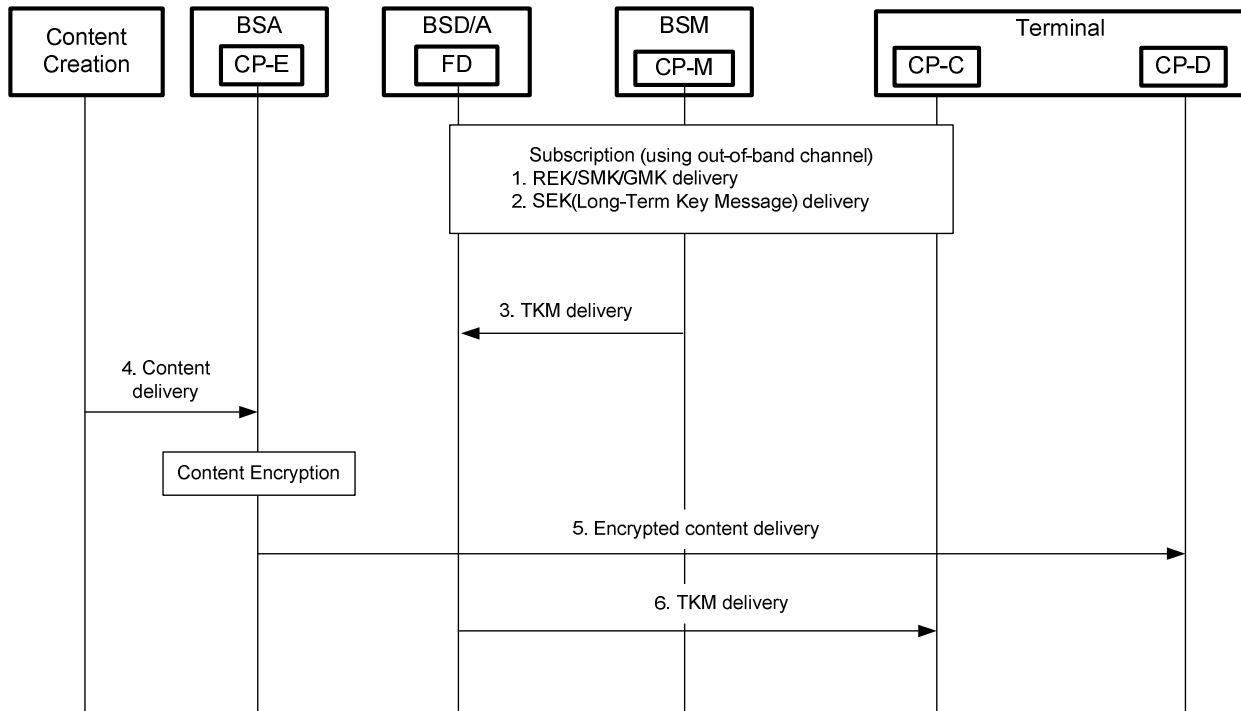

## 5.2.7 Interaction Channel Related Flows

### 5.2.7.1 Interactive Service example Flow – Case1

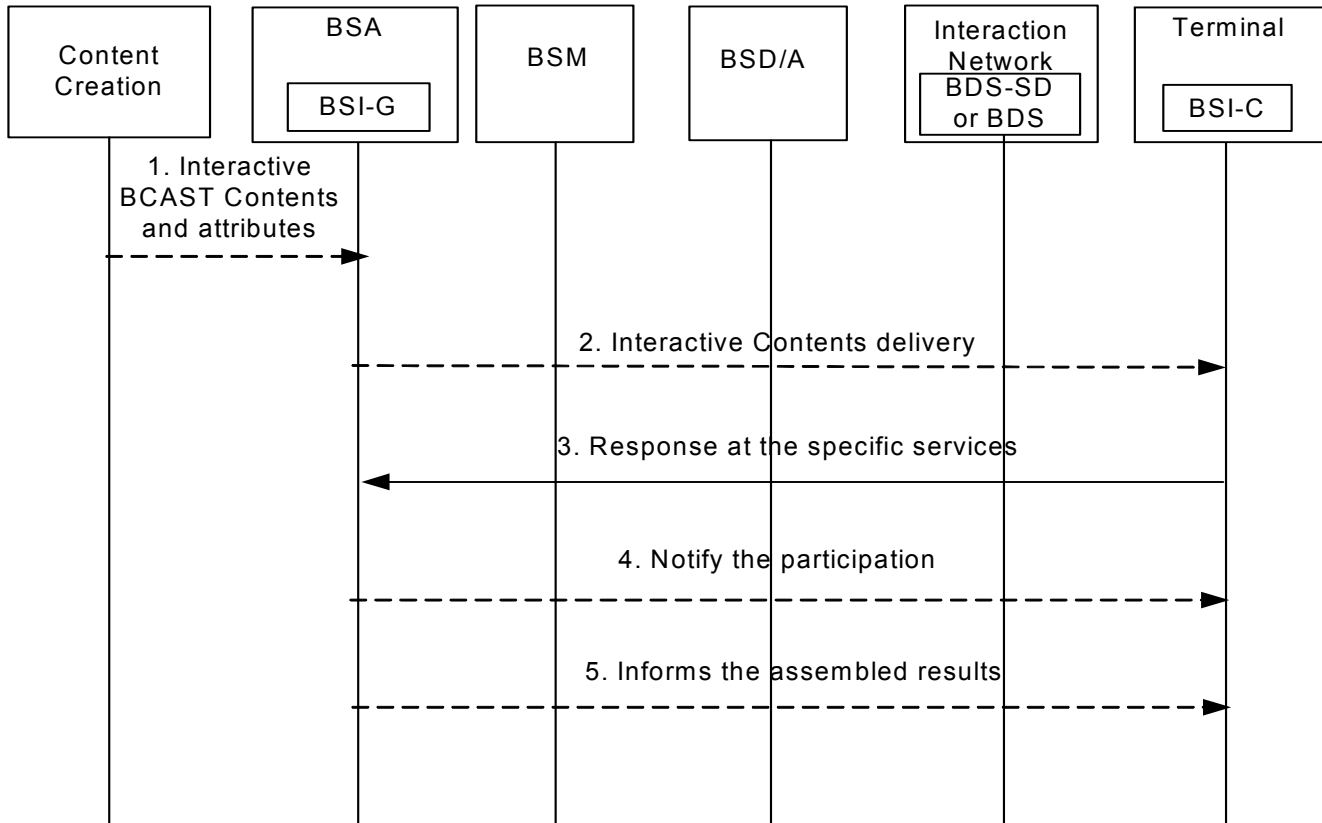



## 5.2.8 Service Provisioning Related Flows

### 5.2.8.1 Service Provisioning Function Related Flows (DRM based solution)

#### 5.2.8.1.1 Unsuccessful Service ordering

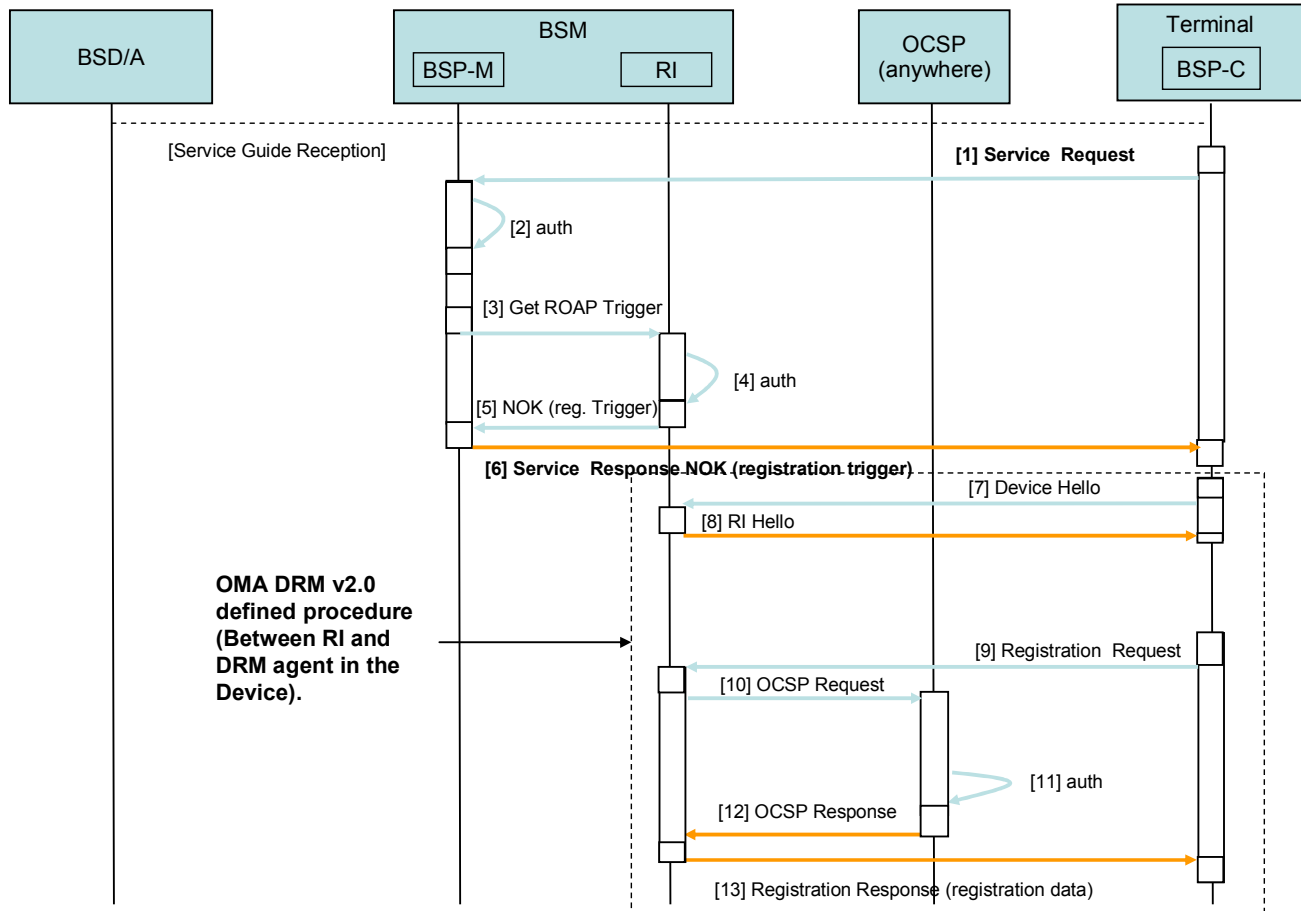

### 5.2.8.1.2 Successful Service ordering

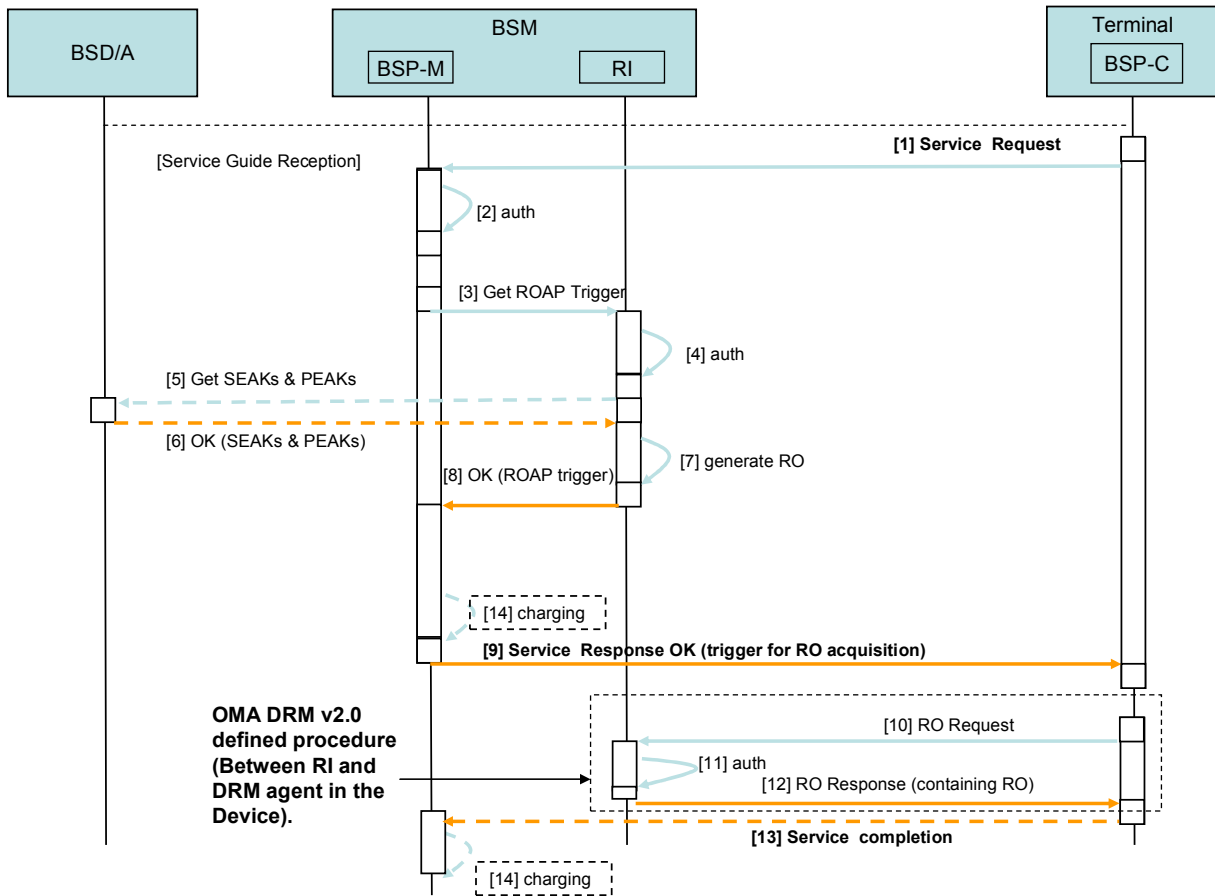

### 5.2.8.2 Service Provisioning Function Related Flows (GBA based solution)

#### 5.2.8.2.1 Option 1: BSP-M Serves as NAF Function

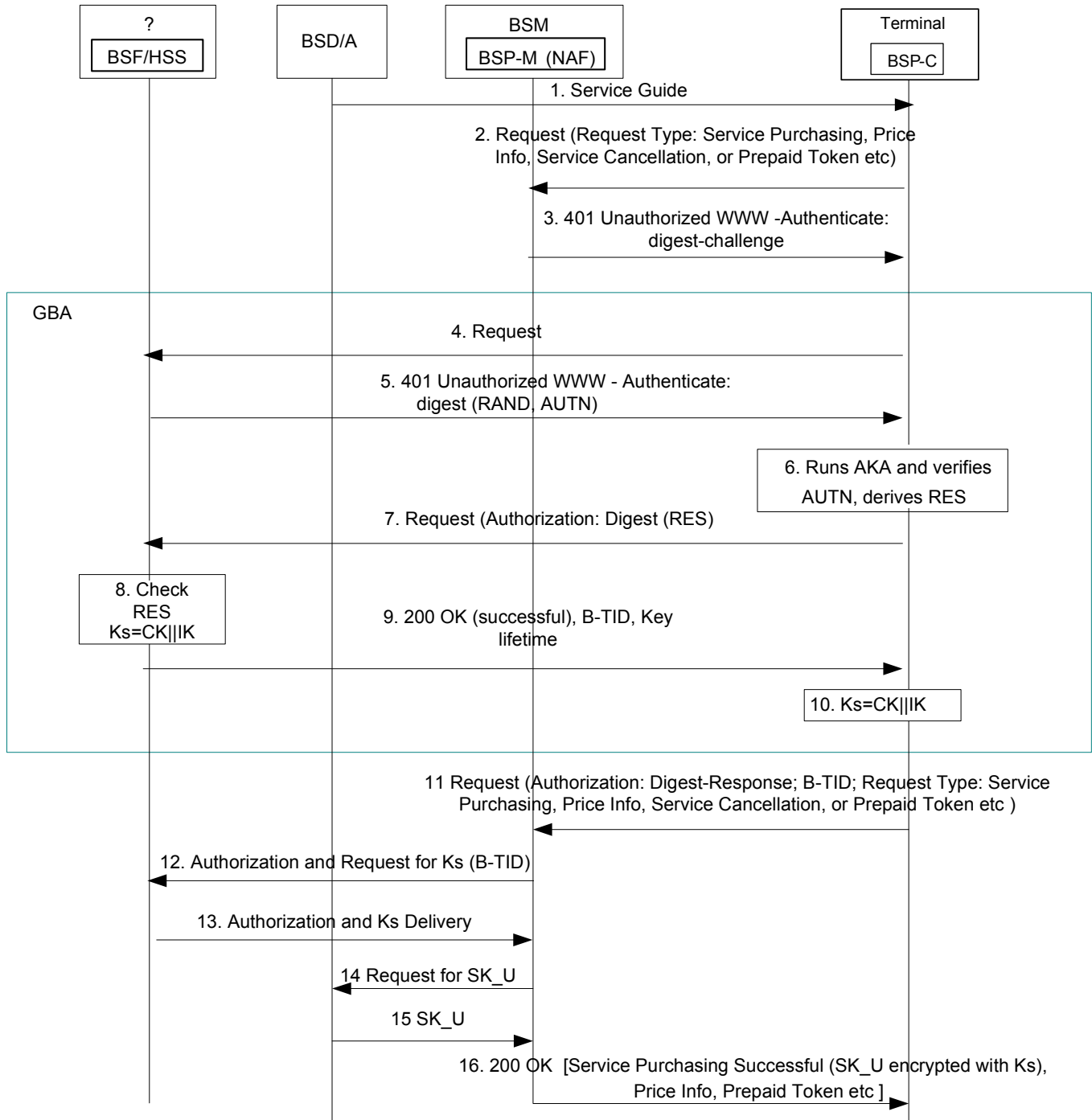

5.2.8.2.2 Option 2: BSD/A serves as NAF Function, BSP-M serves as BSF function

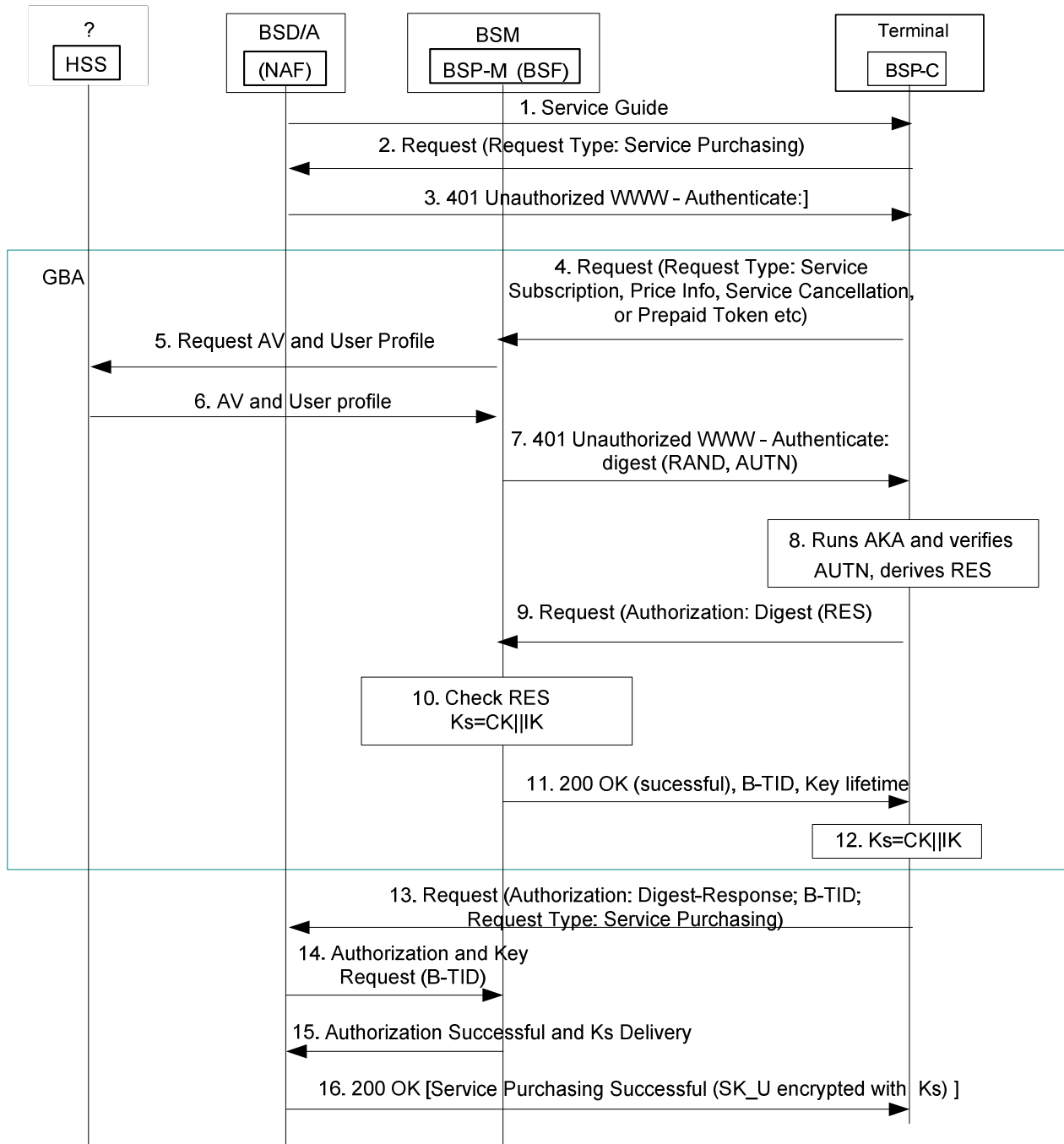

## 5.2.9 Notification Function Related Flows

### 5.2.9.1 Notification Generation and Delivery over Broadcast Channel by OMA BCAST

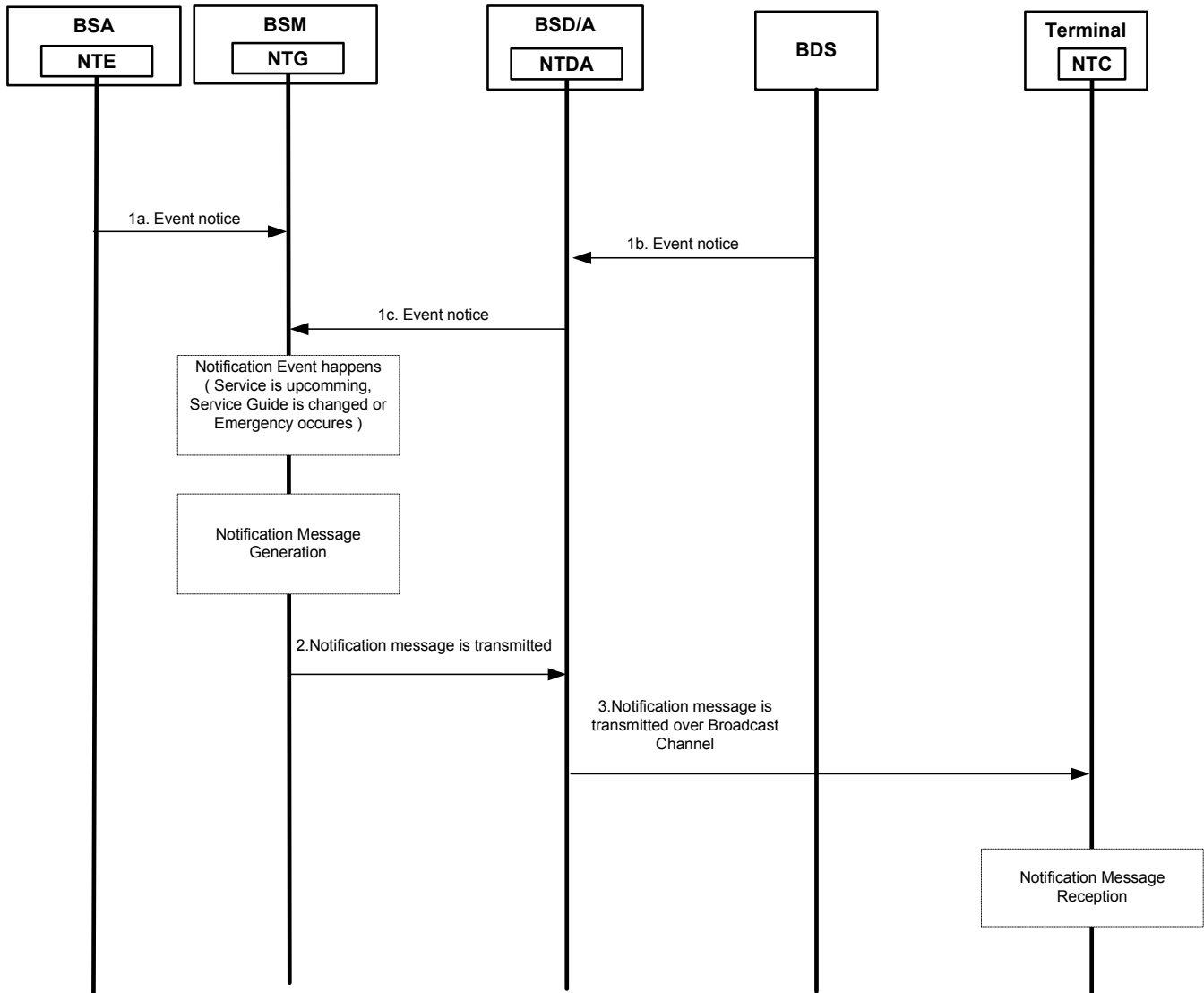

### 5.2.9.2 Notification Delivery over Broadcast channel by BDS

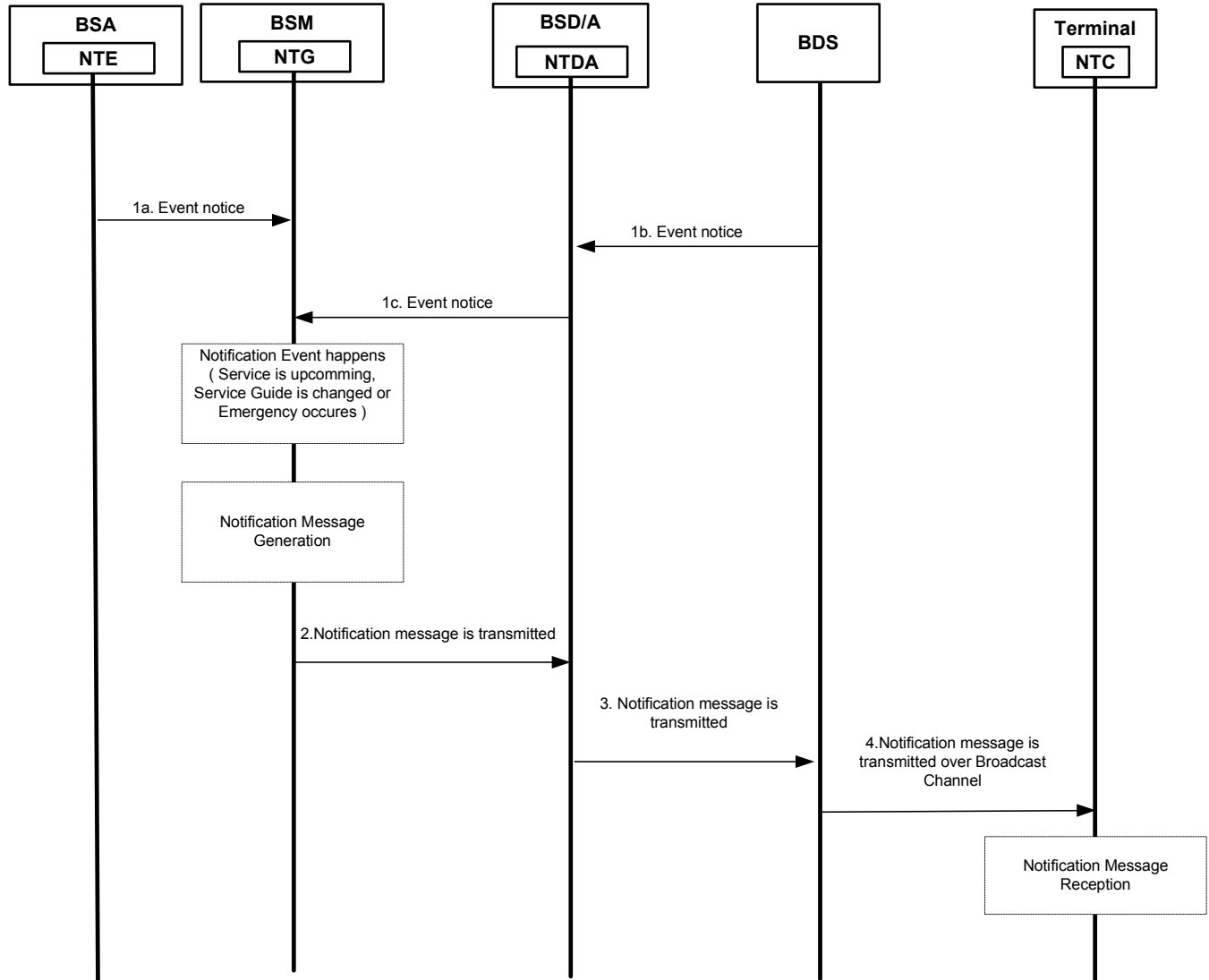

### 5.2.9.3 Notification Delivery over Interaction Channel by OMA BCAST

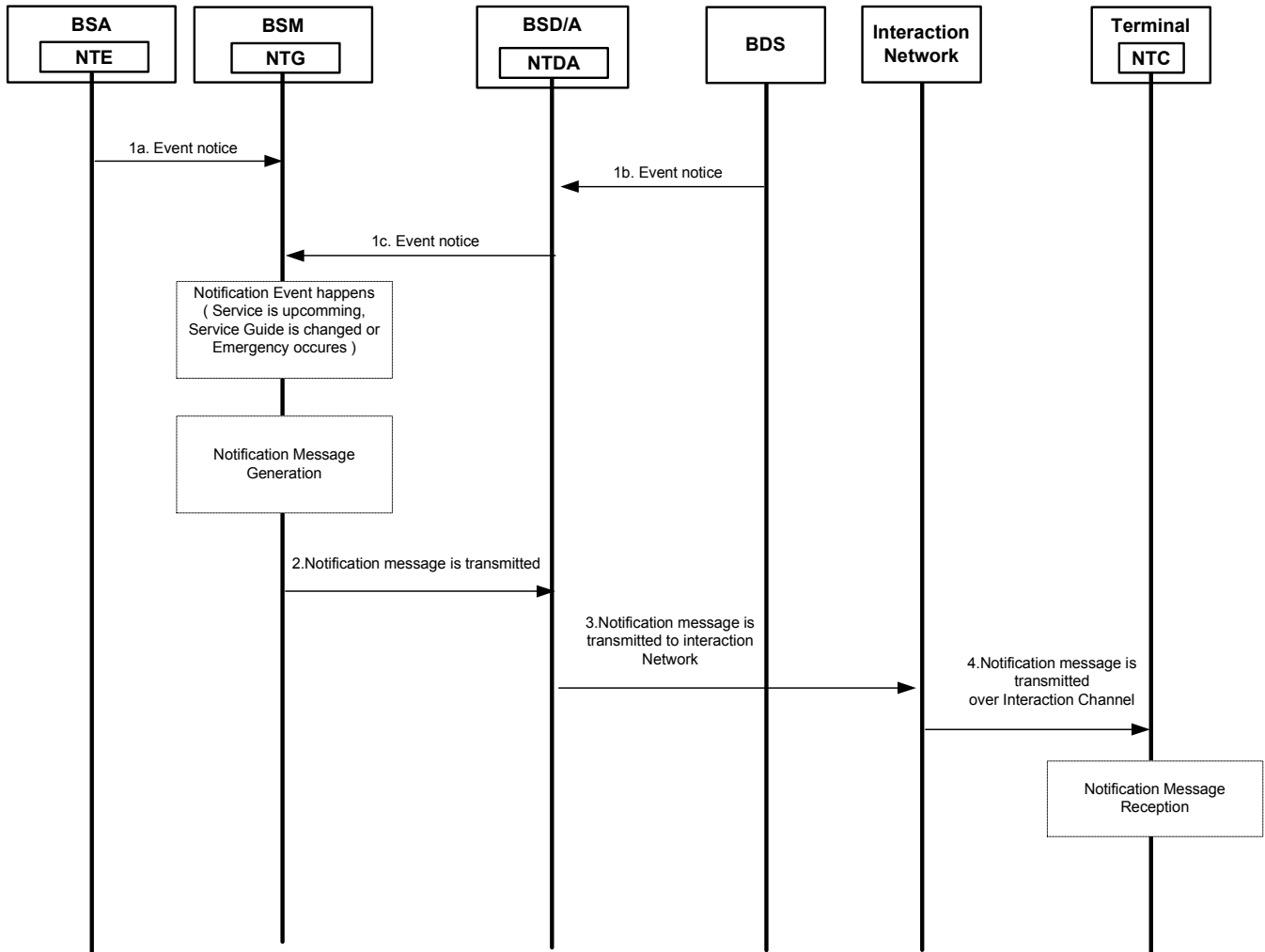

## 5.2.10 Terminal Provisioning Related Flows

### 5.2.10.1 Terminal Provisioning over Broadcast Channel

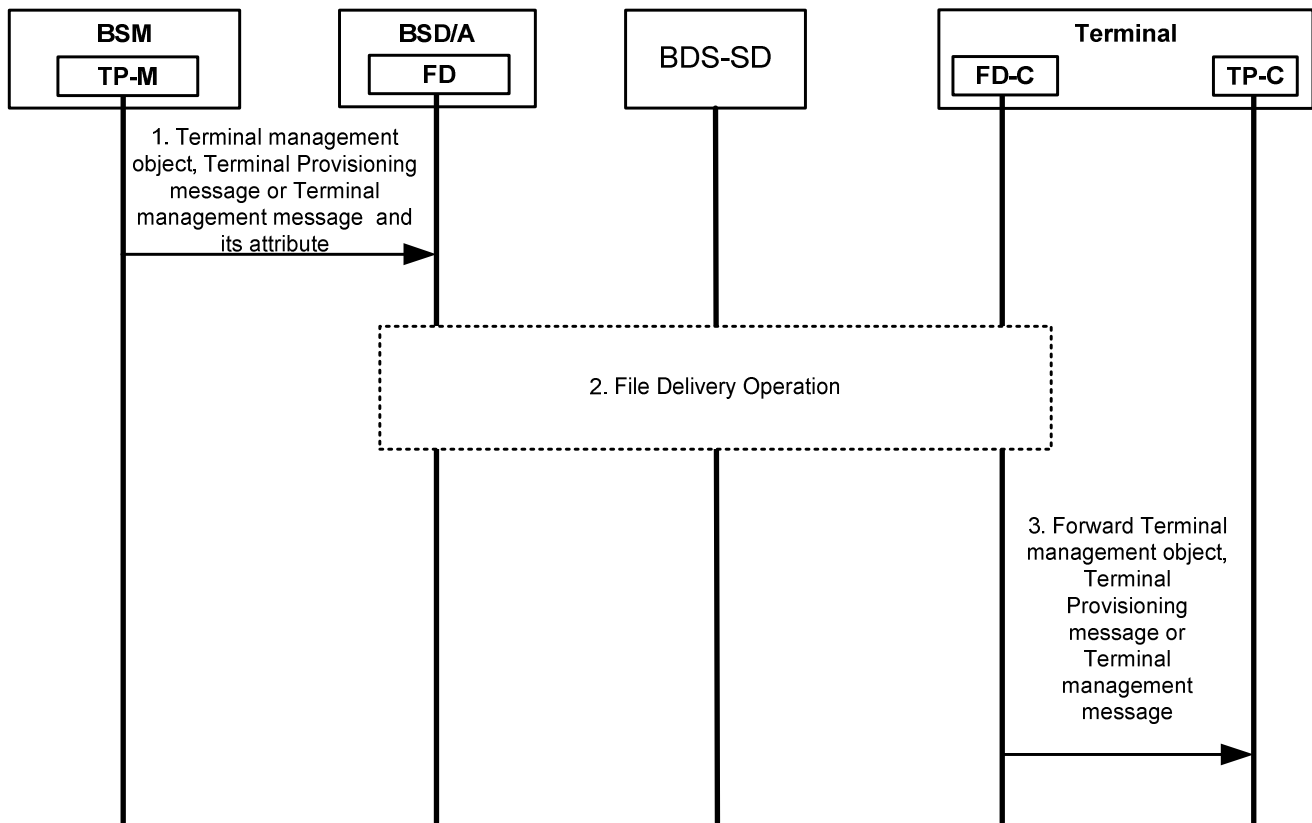

### 5.2.10.2 Terminal Provisioning over Interaction Channel

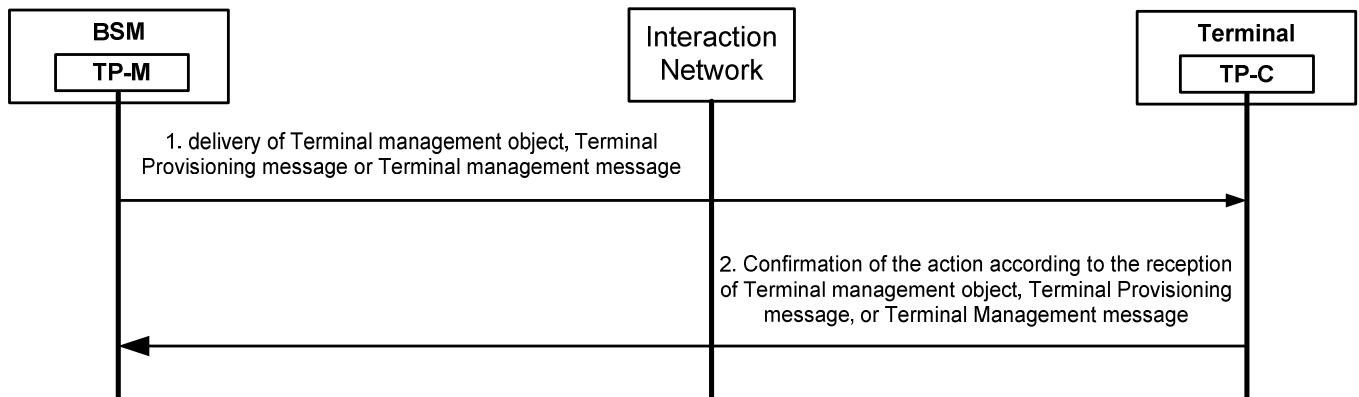

## 5.2.11 Test Content Requirements

For the interoperability tests there is no particular requirement for the test content. The test content has to be adapted to the interoperability test cases.

For the conformance testing the test content will be provided with the test tool in order to satisfy the conformance test cases.



## 5.2.12 Test Limitations

### 5.2.12.1 Physical

When running BDS specific tests then radio equipment is required and terminals with a radio unit must stay in range of the signal.

### 5.2.12.2 Resources

It might be required to have technicians for operating the BDS specific network or for configuring the DRM server, supplying encryption keys and other support services.

It might be necessary that a network operator or Telco supplier provides BDS specific hardware (e.g. a network in a lab or a demo network). Contributions are welcome and should be announced early so that tests fests can be planned properly.

## 5.2.13 Test Restrictions

### 5.2.13.1 Test Session Entrance Criteria

The test session entry criteria are defined by the Test-Fest Participation Guidelines of the IOP WG.

### 5.2.13.2 Technical Prerequisites

- Client settings shall be in accordance with the network parameters provided by the test fest host.
- Gateway and proxy configuration shall be in accordance with the information provided by the test fest host for serving all clients participating in the test fest.

## 5.2.14 Test Tools

A set of TTCN-3 test cases can be used for conformance tests to assess client functionality. The main areas for server tests are the service guide, boot strapping and service protection.

### 5.2.14.1 Existing Tools to be used

It is optional but in case of problems recommended to use a network analyzer like Wireshark (formerly called Ethereal) to create traces for trouble shooting.

In the backend of the conformance test tool or server implementations a collection of existing tools might be required (DRM, codecs, content, keys).

### 5.2.14.2 Conformance Test Case Priorities

This table shows the relative priorities of the conformance test cases as described in the Client Conformance ETS [BCAST10-ETS\_Client].

Test Case Id	Priority
5.1.1.1 Service bootstrap and single content (DVB-H), requires DVB-H BDS.	High
5.1.1.2 Service bootstrap and single content (MBMS), requires MBMS BDS	High
5.1.2.1 Service Guide update (same fragment id, higher version number)	High
5.1.2.2 Service Guide update (same fragment id, lower version number)	High
5.1.2.3 Service Guide Update (new fragment id)	High
5.1.2.4 GZIP compression of Service Guide Delivery Unit	High
5.1.2.5 Content hierarchy	High
5.1.2.6 PreviewData and Service	High
5.1.2.7 Select language specific access parameters	High
5.1.2.8 Subscription of Service	High

Test Case Id	Priority
5.1.2.1.2 Support of in-band delivery of meta-data and FLUTE	Medium
Any additional file delivery test cases	Medium
5.1.4.1 XHTML MP Interactivity	Medium
5.1.4.2 SMS interactivity	Medium
5.1.4.3 MMS Interactivity	Medium
5.1.5.1 Delivery of IPSec protected stream	Medium
5.1.5.2 Delivery of SRTP protected stream	Medium
5.1.5.3 Delivery of ISMACrypt protected stream	Medium
5.1.6.1 Receiving terminal provisioning messages using TP-7	Low
5.1.6.2 Update terminal provisioning messages using TP-7	Low
5.1.6.3 Declaring Terminal Provisioning as a Service within Service Guide	Low
5.1.6.4 Declaring Terminal Provisioning as an Access of a Service within Service	Low

**Table 2: Conformance Test Case Priorities**

### 5.2.14.3 Test Tool Requirements

General info: Test tool should deliver SG and SGDUs with proper fragments as specified by each specific test case.

The network should allow access to streaming/ content repository as defined in the SDP file.

Streaming server capable to deliver content as defined in SDP description.

ID	BCAST_001 (Functionality)
Requirement	The test tool shall have the functionality to verify the BCAST features as specified in [BCAST10-ETS_Client] and [BCAST10-ETR].
Rationale	A test harness is required for all tests which are not interoperability tests.
Must Level	Ability to run all high priority test cases as described in Table 1.
Wish Level	Ability to run all high and medium priority test cases. Note: Low priority test cases are left for future consideration.

ID	BCAST_002 (Connectivity)
Requirement	The test tool running the TTCN-3 code shall connect to the applications under test via TCP/IP over Ethernet.
Rationale	The test can be limited to IP level. Radio hardware or radio specific low level protocols are not part of the test tool. However – the test tool needs to be prepared to be connected to radio equipment in order to connect to clients and servers. The test must interwork with <ul style="list-style-type: none"> <li>• IPDC (DVB-H) clients and servers</li> <li>• MBMS clients and servers</li> <li>• BCMCS clients and servers</li> </ul> The test tool vendor is not expected to provide BDS specific hardware but is expected to cooperate with providers of BDS specific hardware (in case a network operator or Telco supplier provides BDS specific hardware). The TTCN-3 code must enable the above connection types.
Must Level	IPv4
Wish Level	IPv4 and IPv6

ID	BCAST_003 (Source code access)
Requirement	The TTCN-3 code should be available for changes.
Rationale	Having the source code available enables quick bug fixing and extension of functionality without time consuming communication with the software vendor.
Must Level	The TTCN-3 code is owned by OMA and can be made available for OMA members.
Wish Level	N/A

In consideration of vendors concerns: The requirement above does not demand Open Source. It defines Open Source as optional.

ID	BCAST_004 (Configuration)
Requirement	The TTCN-3 code enables easy configurability on the tool that runs it.
Rationale	Configuration time is the time from having a fresh installation up to the point when a test can be started. Configuration can include <ul style="list-style-type: none"> <li>• setting IP addresses</li> <li>• loading test data</li> <li>• setting the name of the server that will be tested</li> <li>• specifying the test cases which should be executed</li> </ul> etc.
Must Level	N/A
Wish Level	N/A

ID	BCAST_005 (Test Results)
Requirement	The TTCN-3 code allows easy collection and storage of the test results.
Rationale	
Must Level	Test results can be easily collected and stored.
Wish Level	

## 5.2.15 Resources Required

No estimate so far – depends highly on the maturity of individual enabler implementations. For a good estimate in this chapter input from implementation providers is required later on.

## 5.3 Tests to be Performed

The following sections describe the tests related to the formal TestFest validation activities.

### 5.3.1 Minimal Pre-Test Guidelines

This section details a set of test cases that the Trusted Zone requires participating companies to perform during the Pre-Test day. The order of the listed tests is only intended as advice to participating teams and not necessarily to indicate that the sequence of execution is mandatory.

The results will be considered across all Pre-Test sessions that a team will perform during the Pre-Test day and will NOT be included in any Product Test Report or Enabler Test Report generated as a result of participation in the event.

If the team is unable to present passing results for all listed below Pre-Test test cases and if the failures are due to team's implementation, the team shall not be allowed to proceed with regular test sessions. The host shall provide adequate space for the teams to sit separately and improve their implementations. The teams should validate the implementation with the passing teams at the passing teams' discretion. Once passing results for all Pre-Test test cases are presented, the team should be allowed to proceed with regular testing.

#### 5.3.1.1 Service Guide (SG)

The purpose is to check reception and handling of SG, not method of delivery. In case of broadcast terminals BCAST-1.0-DIST-int-103 is executed. Terminals implementing delivery over interaction channel are required to execute BCAST-1.0-DIST-int-104

Test Case Id	Test Case Description
BCAST-1.0-DIST-int-103	Updating description of content. This test case also tests that the update of the SG is performed correctly.
BCAST-1.0-DIST-int-104	Updating description of content. This test case also tests that the update of the SG is performed correctly.

#### 5.3.1.2 Stream Distribution (SD)

Test Case Id	Test Case Description
BCAST-1.0-DIST-int-208	The purpose of this test is to test the supports of RTP as a transport protocol for streaming distribution over the broadcast channel.

#### 5.3.1.3 File Distribution (FD)

Test Case Id	Test Case Description
BCAST-1.0-DIST-int-202	To test the support of the in-band delivery of the metadata associated with file distributed using FLUTE.

#### 5.3.1.4 Service Protection (ServProt)

## DRM

Only one of the recommended test cases need to be executed depending upon the type of encryption implemented by the participant.

Test Case Id	Test Case Description
BCAST-1.0-DIST-int-401	Opening an Ipsec encrypted stream with key material associated to the subscription
BCAST-1.0-DIST-int-402	Opening an SRTP encrypted stream with key material associated to the subscription
BCAST-1.0-DIST-int-403	Opening an ISMACrypt encrypted stream with key material associated to the subscription.

## SmartCard

Test cases BCAST-1.0-DIST-int-404 and BCAST-1.0-DIST-int-430 must be executed by all USIM implementations.

Test Case Id	Test Case Description
BCAST-1.0-DIST-int-404	Test that GBA bootstrapping with the BSM is successfully achieved. Test that the SRK is correctly generated in the terminal.
BCAST-1.0-DIST-int-430	Test that the Smartcard correctly parses STKMs.

Test cases BCAST-1.0-DIST-int-410 and BCAST-1.0-DIST-int-430 must be executed by all (R-)UIM/CSIM implementations.

Test Case Id	Test Case Description
BCAST-1.0-DIST-int-410	Test that SMK and SRK derivation from pre-provisioned SCK in the terminal are successful.
BCAST-1.0-DIST-int-430	Test that the Smartcard correctly parses STKMs.

### 5.3.1.5 Content Protection (ContProt)

#### DRM

No explicit test cases.

#### SmartCard

No explicit test cases.

### 5.3.1.6 Service Provisioning (SP)

Test Case Id	Test Case Description
BCAST-1.0-DIST-int-101	Bootstrapping a service with content. Associating content with service. This test case also tests that the reception of the SG is performed correctly.

### 5.3.1.7 Service Interaction (SI)

Test Case Id	Test Case Description
BCAST-1.0-DIST-int-301	Associating content with interactivity. Reception of InteractivityMediaDocuments over broadcast file distribution. XHTML MP as an interaction method.

### 5.3.1.8 Notification (N)

No test cases available.

### 5.3.1.9 Terminal Provisioning (SP)

Test Case Id	Test Case Description
BCAST-1.0-DIST-int-501	The purpose of this test is to check that the terminal correctly receives provisioning messages using TP-7 over the interactive channel.

## 5.3.2 Pre testing to be performed at the TestFest

During Pre-Testing at an OMA Test Fests participant teams must demonstrate correct execution of the following test cases:

- 5.1.1 Service bootstrap and single content
- 5.2.3 GZIP compression of Service Guide Delivery Unit

## 5.3.3 Testing to be Performed at TestFest

The testing at the BCAST Test Fests is expected to be executed according to the BCAST Interoperability Enabler Test Specification [BCAST10-ETS\_IOP]. See also chapter 5.1.3.

## 5.4 Enabler Test Reporting

### 5.4.1 Problem Reporting Requirements

Normal Reporting, no special reporting required.

### 5.4.2 Enabler Test Requirements

Normal Reporting, no special reporting required

## 6 Alternative Validation Activities

So far no alternative validation activities are specified.

## 7 Approval Criteria

The BCAST 1.0 Enabler can be put in the Approved state when:

- The Enabler has been tested successfully at 3 Test Fests or
- 3 Companies have successfully run BI-lateral tests sessions towards a BCAST server and have reported results and any issues to OMA. This means three for each BDS and not one IPDC, one for MBMS and one for BCMCS.
- No open PRs exists.



## Appendix A. Change History (Informative)

### A.1 Approved Version History

Reference	Date	Description
n/a	n/a	No prior version –or- No previous version within OMA

### A.2 Draft/Candidate Version 1.0 History

Document Identifier	Date	Sections	Description
Draft Versions OMA-ETG-BCAST-V1_0	24 July 2006	All	Initial document to address the basic starting point
	24 September 2006	Chapter 4 and 5	Updated according to comments from Nokia and BAC BCAST
	27 September 2006	Chapter 4.2, 5.1, 5.6, 6.3	Updated according to comments from the review during the conference call 26 September 2006
	14 October 2006	Chapter 5.6 and 6.3	Updated according to comments from the review during the conference call 03 October 2006
	04 November	mainly Chapter 5	Changes after the F2F meeting in Athens
	19 November	Chapter 5.6.1	TTCN requirement removed from chapter 5.6.1 according to decision from the conference call from 07 November
	14 December	Chapter 5.2 and 5.3	Updated document with the input from NEC: OMA-IOP-BRO-2006-0225R01-CR_BCAST_ETG_Execution_Flow.doc
	22 January 2007	just date change	The document has been discussed during a teleconference and it has been decided to put the document on the permanent documents section.
Draft Versions OMA-EVP-BCAST-V1_0	16 April 2007	All	converted ETG to EVP
	10 May 2007	Chapter 2.2, 5.1.3, 5.2.6.2, 5.2.6.3, 5.3.1, 5.3.2 and 5.3.3.	Setting priorities for conformance test cases. TestFest entry criteria clarified.
	29 May 2007	5.3.1.	More entry criteria test cases added. Table numbers fixed.
	19 July 2007	5.3.1	Addition of CR IOP BRO 131R01
	24 Jul 2007	2	Editorial Corrections to references and ToC
		n/a	Prepared for TP candidate approval as doc ref # OMA-TP-2007-0299-INP_EVP_BCAST_V1_0_for_Candidate_Approval
Candidate Version OMA-EVP-BCAST-V1_0	07 Aug 2007	All	Status changed to Candidate by TP TP ref # OMA-TP-2007-0299-INP_EVP_BCAST_V1_0_for_Candidate_Approval
Draft Versions OMA-EVP-BCAST-V1_0	19 Sep 2007	2, 5.2, 5.3.1	Incorporated CRs: OMA-IOP-BRO-2007-0188R01 OMA-IOP-BRO-2007-0232R01
	04 Oct 2007	n/a	IOP WG agreed, IOP doc # OMA-IOP-2007-0193-INP_Updated_OMA_EVP_BCAST_V1_0
Candidate Version OMA-EVP-BCAST-V1_0	19 Oct 2007	n/a	Reapproved as Candidate, TP doc ref # OMA-TP-2007-0417R02-INP_EVP_BCAST_V1_0_for_Candidate_reapproval
Draft Versions OMA-EVP-BCAST-V1_0	19 Nov 2007	5.3.1	Incorporated CR: OMA-IOP-BRO-2007-0262
	21 Nov 2007	5.1.3	Incorporated CR: OMA-IOP-BRO-2007-0269 Preparation for IOP WG R&A, IOP doc # OMA-IOP-2007-0241-INP_BCAST_EVP_update_CR_269
	26 Nov 2007	n/a	Preparation for TP R&A, TP doc # OMA-TP-2007-0479-INP_EVP_BCAST_V1_0_for_candidate_reapproval
Candidate Version OMA-EVP-BCAST-V1_0	28 Jan 2008	n/a	Re-approved as candidate Dec 11 <sup>th</sup> 2007, TP doc # OMA-TP-2007-0479-INP_EVP_BCAST_V1_0_for_candidate_reapproval