



BCAST Distribution System Adaptation – IPDC over DVB-SH

Candidate Version 1.1 – 14 Sep 2010

Open Mobile Alliance
OMA-TS-BCAST_DVBSH_Adaptation-V1_1-20100914-C

Use of this document is subject to all of the terms and conditions of the Use Agreement located at <http://www.openmobilealliance.org/UseAgreement.html>.

Unless this document is clearly designated as an approved specification, this document is a work in process, is not an approved Open Mobile Alliance™ specification, and is subject to revision or removal without notice.

You may use this document or any part of the document for internal or educational purposes only, provided you do not modify, edit or take out of context the information in this document in any manner. Information contained in this document may be used, at your sole risk, for any purposes. You may not use this document in any other manner without the prior written permission of the Open Mobile Alliance. The Open Mobile Alliance authorizes you to copy this document, provided that you retain all copyright and other proprietary notices contained in the original materials on any copies of the materials and that you comply strictly with these terms. This copyright permission does not constitute an endorsement of the products or services. The Open Mobile Alliance assumes no responsibility for errors or omissions in this document.

Each Open Mobile Alliance member has agreed to use reasonable endeavors to inform the Open Mobile Alliance in a timely manner of Essential IPR as it becomes aware that the Essential IPR is related to the prepared or published specification. However, the members do not have an obligation to conduct IPR searches. The declared Essential IPR is publicly available to members and non-members of the Open Mobile Alliance and may be found on the “OMA IPR Declarations” list at <http://www.openmobilealliance.org/ipr.html>. The Open Mobile Alliance has not conducted an independent IPR review of this document and the information contained herein, and makes no representations or warranties regarding third party IPR, including without limitation patents, copyrights or trade secret rights. This document may contain inventions for which you must obtain licenses from third parties before making, using or selling the inventions. Defined terms above are set forth in the schedule to the Open Mobile Alliance Application Form.

NO REPRESENTATIONS OR WARRANTIES (WHETHER EXPRESS OR IMPLIED) ARE MADE BY THE OPEN MOBILE ALLIANCE OR ANY OPEN MOBILE ALLIANCE MEMBER OR ITS AFFILIATES REGARDING ANY OF THE IPR'S REPRESENTED ON THE “OMA IPR DECLARATIONS” LIST, INCLUDING, BUT NOT LIMITED TO THE ACCURACY, COMPLETENESS, VALIDITY OR RELEVANCE OF THE INFORMATION OR WHETHER OR NOT SUCH RIGHTS ARE ESSENTIAL OR NON-ESSENTIAL.

THE OPEN MOBILE ALLIANCE IS NOT LIABLE FOR AND HEREBY DISCLAIMS ANY DIRECT, INDIRECT, PUNITIVE, SPECIAL, INCIDENTAL, CONSEQUENTIAL, OR EXEMPLARY DAMAGES ARISING OUT OF OR IN CONNECTION WITH THE USE OF DOCUMENTS AND THE INFORMATION CONTAINED IN THE DOCUMENTS.

© 2010 Open Mobile Alliance Ltd. All Rights Reserved.

Used with the permission of the Open Mobile Alliance Ltd. under the terms set forth above.

Contents

1. SCOPE	5
2. REFERENCES	6
2.1 NORMATIVE REFERENCES.....	6
2.2 INFORMATIVE REFERENCES.....	7
3. TERMINOLOGY AND CONVENTIONS	8
3.1 CONVENTIONS.....	8
3.2 DEFINITIONS.....	8
3.3 ABBREVIATIONS.....	9
4. INTRODUCTION	11
4.1 VERSION 1.1.....	11
5. OVERVIEW OF DVB-SH AND IP DATACAST (INFORMATIVE)	12
5.1 SYSTEM OVERVIEW.....	12
5.2 CONFIGURATIONS IN SCOPE.....	12
5.3 DVB-SH TRANSPORT STREAM.....	13
5.4 SPECIFICATIONS.....	15
6. GENERIC ADAPTATION OVER DVB-SH IP TRANSMISSION NETWORK	16
6.1 ACCESS TO THE IP LAYER.....	16
6.2 GENERIC ADAPTATION RELATED TO OMA-TS-BCAST_SERVICES.....	16
6.2.1 Interaction.....	16
6.2.2 Service Provisioning.....	16
6.2.3 Terminal Provisioning.....	16
6.2.4 Notification.....	17
6.3 GENERIC ADAPTATION RELATED TO OMA-TS-BCAST_SERVICEGUIDE.....	17
6.3.1 Service Guide Delivery over Broadcast Channel.....	17
6.3.2 Compression of Service Guide Delivery Units.....	17
6.3.3 Session Description.....	17
6.3.4 Service Guide Data Model.....	18
6.3.5 Service Guide Discovery.....	21
6.4 GENERIC ADAPTATION RELATED TO OMA-TS-BCAST_SVCNTPROTECTION AND OMA-TS-DRM-XBS.....	24
6.5 GENERIC ADAPTATION RELATED TO OMA-TS-BCAST-DISTRIBUTION.....	25
6.5.1 File Distribution.....	25
6.5.2 Associated Delivery Procedures.....	25
6.5.3 Stream Distribution.....	25
6.5.4 Media codecs.....	25
7. BDS SPECIFIC ADAPTATION TO DVB-SH IPDC FUNCTIONALITY	26
8. WALKTHROUGH: DISTRIBUTION OF BCAST SERVICES OVER DVB-SH (INFORMATIVE)	27
8.1 POWER UP, NETWORK ATTACHMENT, INITIAL PROCEDURES.....	27
8.2 SERVICE GUIDE BOOTSTRAPPING.....	29
8.3 SERVICE GUIDE RECEPTION AND UPDATE.....	29
8.4 SERVICE ORDERING.....	30
8.5 SERVICE RECEPTION.....	30
8.5.1 Streaming Service.....	30
8.5.2 Download Service.....	30
APPENDIX A. CHANGE HISTORY (INFORMATIVE)	31
A.1 APPROVED VERSION HISTORY.....	31
A.2 DRAFT/CANDIDATE VERSION 1_1 HISTORY.....	31
APPENDIX B. STATIC CONFORMANCE REQUIREMENTS (NORMATIVE)	32
B.1 SCR FOR BCAST TERMINAL.....	32
B.2 SCR FOR BCAST BSM.....	33
B.3 SCR FOR BCAST BSD/A.....	33

B.4	SCR FOR BCAST BSA	34
APPENDIX C. REGIONALIZED SERVICE GUIDE SCENARIOS (INFORMATIVE).....		35
C.0	OVERVIEW.....	35
C.1	SCENARIO OF BROADCAST AREA INSTANTIATIONS AND USAGES.....	35
C.2	SCENARIO OF BASIC COMMON AND LOCAL SG DELIVERY	37
C.3	SCENARIO OF MIXING COMMON AND LOCAL PURCHASE INFORMATION.....	38
C.4	SCENARIO OF COMPLEMENTING COMMON SG FRAGMENTS USING LOCAL SG DELIVERY CHANNELS	38
C.5	SCENARIO OF OVERRIDING COMMON CONTENT ITEM BY LOCAL CONTENT ITEM.....	39
C.6	SCENARIO OF MIXED PURCHASE ITEM DELIVERED ON COMMON SG DELIVERY CHANNEL.....	40

Figures

Figure 1:	DVB-SH system configurations.....	13
Figure 2:	Local content insertion via content removal	14
Figure 3:	Example of relationships between bootstrap sessions and descriptors.....	24
Figure 4:	Illustration of the function of PAT and PMT tables in MPEG-2 TS.....	27
Figure 5:	Scenarios of SG Broadcast Area instantiations and usages.....	36
Figure 6:	Scenario of basic common and local SG delivery	37
Figure 7:	Scenario of mixing common and local purchase information	38
Figure 8:	Scenario of complementing common SG fragments using local SG delivery channels.....	39
Figure 9:	Scenario of overriding common content item by local content item.....	40
Figure 10:	Scenario of mixed purchase item delivery on common SG delivery channel.....	41

Tables

Table 1:	BCAST Management Object and its sub-nodes.....	17
----------	--	----

1. Scope

This document specifies how the BCAST 1.1 Enabler is implemented over a specific BDS (BCAST Distribution System).

The BCAST 1.1 Enabler supports the global interoperability among different BCAST Distribution Systems, and can also be adapted according to the characteristics of BCAST Distribution Systems. In this document, two types of adaptations are presented.

The BCAST 1.1 Enabler includes nine functions and all nine functions can be implemented over any specific BDS with minimal adaptation. This is referred to as "generic adaptation", which can be applied for any kind of BDS.

The underlying BDS may already have a method for a function defined in the BCAST 1.1 Enabler. This specification defines how the BCAST functionality is adapted to the method selected in the underlying BDS. This is referred to as "BDS specific adaptation".

This is further explained in Section 4 Introduction.

2. References

2.1 Normative References

- [BCAST11-Distribution] "File and Stream Distribution for Mobile Broadcast Services ", Open Mobile Alliance™, OMA-TS-BCAST_Distribution-V1_1,
[URL:http://www.openmobilealliance.org/](http://www.openmobilealliance.org/)
- [BCAST11-ServContProt] "Service and Content Protection for Mobile Broadcast Services", Open Mobile Alliance™, OMA-TS-BCAST_SvcCntProtection-V1_1,
[URL:http://www.openmobilealliance.org/](http://www.openmobilealliance.org/)
- [BCAST11-Services] "Mobile Broadcast Services", Open Mobile Alliance™, OMA-TS-BCAST_Services-V1_1,
[URL:http://www.openmobilealliance.org/](http://www.openmobilealliance.org/)
- [BCAST11-SG] "Service Guide for Mobile Broadcast Services", Open Mobile Alliance™, OMA-TS-BCAST_ServiceGuide-V1_1,
[URL:http://www.openmobilealliance.org/](http://www.openmobilealliance.org/)
- [DRM20-Broadcast-Extensions] "OMA DRM v2.0 Extensions for Broadcast Support", Open Mobile Alliance™, OMA-TS-DRM-XBS-V1_1,
[URL:http://www.openmobilealliance.org/](http://www.openmobilealliance.org/)
- [ETSI EN 300 468] ETSI EN 300 468 v1.x.x, "Digital Video Broadcasting (DVB); Specification for Service Information (SI) in DVB systems",
[URL:http://portal.etsi.org/](http://portal.etsi.org/)
- [ETSI EN 302 583] ETSI EN 302 583 v1.x.x, "Digital Video Broadcasting (DVB); Framing Structure, channel coding and modulation for Satellite Services to Handheld devices (SH) below 3 GHz",
[URL:http://portal.etsi.org/](http://portal.etsi.org/)
- [ETSI TS 102 005] ETSI TS 102 005 v1.x.x, "Specification for the use of video and audio coding in DVB services delivered directly over IP",
[URL:http://portal.etsi.org/](http://portal.etsi.org/)
- [ETSI TS 102 471] ETSI TS 102 471 v1.x.x, "Digital Video Broadcasting (DVB); IP Datacast over DVB-H: Electronic Service Guide ()",
[URL:http://portal.etsi.org/](http://portal.etsi.org/)
- [ETSI TS 102 472] ETSI TS 102 472 v1.x.x, "Digital Video Broadcasting (DVB); IP Datacast over DVB-H: Content Delivery Protocols",
[URL:http://portal.etsi.org/](http://portal.etsi.org/)
- [ETSI TS 102 470-2] ETSI TS 102 470-2 v1.x.x, "Digital Video Broadcasting (DVB); Program Specific Information (PSI)/Service Information (SI); Part 2: IP Datacast over DVB-SH",
[URL:http://portal.etsi.org/](http://portal.etsi.org/)
- [ETSI TS 102 611-2] ETSI TS 102 611-2 v1.x.x, "Digital Video Broadcasting (DVB); IP Datacast: Implementation Guidelines for Mobility; Part 2: IP Datacast over DVB-SH",
[URL:http://portal.etsi.org/](http://portal.etsi.org/)
- [IOPPROC] "OMA Interoperability Policy and Process", Version 1.1, Open Mobile Alliance™, OMA-IOP-Process-V1_1,
[URL:http://www.openmobilealliance.org/](http://www.openmobilealliance.org/)
- [ISMACryp] "ISMA Encryption and Authentication v1.1.", Internet Streaming Media Alliance,
[URL:http://www.isma.tv/](http://www.isma.tv/)
- [RFC1952] IETF RFC 1952 "GZIP file format specification version 4.3", P. Deutsch, May 1996,
[URL:http://www.ietf.org/rfc/rfc1952.txt](http://www.ietf.org/rfc/rfc1952.txt)
- [RFC2119] IETF RFC 2119 "Key words for use in RFCs to Indicate Requirement Levels", S. Bradner, March 1997,
[URL:http://www.ietf.org/rfc/rfc2119.txt](http://www.ietf.org/rfc/rfc2119.txt)
- [RFC4234] "Augmented BNF for Syntax Specifications: ABNF". D. Crocker, Ed., P. Overell. October 2005,
[URL:http://www.ietf.org/rfc/rfc4234.txt](http://www.ietf.org/rfc/rfc4234.txt)
- [SCRRULES] "SCR Rules and Procedures", Open Mobile Alliance™, OMA-ORG-SCR_Rules_and_Procedures,

[URL:http://www.openmobilealliance.org/](http://www.openmobilealliance.org/)

[TVA-Metadata] ETSI TS 102 822-3-1 v1.3.1, "Broadcast and On-line Services: Search, select, and rightful use of content on personal storage systems (TV-Anytime)",
[URL:http://portal.etsi.org/](http://portal.etsi.org/)

2.2 Informative References

[ETSI TR 102 469] ETSI TR 102 469 v1.x.x, "Digital Video Broadcasting (DVB); IP Datacast over DVB-H: Architecture",
[URL:http://portal.etsi.org/](http://portal.etsi.org/)

[ETSI TS 102 474] ETSI TS 102 474 v1.x.x, "Digital Video Broadcasting (DVB); IP Datacast over DVB-H: Service Purchase and Protection",
[URL:http://portal.etsi.org/](http://portal.etsi.org/)

[ETSI TS 102 584] ETSI TS 102 584 v1.x.x, "Digital Video Broadcasting (DVB); DVB-SH Implementation Guidelines",
[URL:http://portal.etsi.org/](http://portal.etsi.org/)

[ETSI TS 102 585] ETSI TS 102 585 v1.x.x, "System Specifications for Satellite services to Handheld devices (SH) below 3 GHz",
[URL:http://portal.etsi.org/](http://portal.etsi.org/)

[ETSI TS 102 592-2] ETSI TS 102 592-2 v1.x.x, "Digital Video Broadcasting (DVB); IP Datacast: Electronic Service Guide (ESG) Implementation Guidelines; Part 2: IP Datacast over DVB-SH",
[URL:http://portal.etsi.org/](http://portal.etsi.org/)

[OMADICT] "Dictionary for OMA Specifications", Version x.y, Open Mobile Alliance™,
OMA-ORG-Dictionary-Vx_y,
[URL:http://www.openmobilealliance.org/](http://www.openmobilealliance.org/)

3. Terminology and Conventions

3.1 Conventions

The key words “MUST”, “MUST NOT”, “REQUIRED”, “SHALL”, “SHALL NOT”, “SHOULD”, “SHOULD NOT”, “RECOMMENDED”, “MAY”, and “OPTIONAL” in this document are to be interpreted as described in [RFC2119].

All sections and appendixes, except “Scope” and “Introduction”, are normative, unless they are explicitly indicated to be informative.

This is an informative document, which is not intended to provide testable requirements to implementations.

3.2 Definitions

BCAST Distribution System	A system typically but not necessarily containing the ability to transmit the same IP flow to multiple Terminal devices simultaneously. A BCAST Distribution System (BDS) typically uses techniques that achieve efficient use of radio resources. A BDS consists of Network functionality up to the IP layer and optional Service Distribution/Adaptation functionality above the IP layer. Most BDSs support broadcast/multicast distribution in the network. Some BCAST Distribution Systems have the capability to deliver the IP flows in the network via unicast.
Broadcast Service	<p>A Broadcast Service is a “content package” suitable for simultaneous distribution to many recipients (potentially) without knowing the recipient. Either each receiver has similar receiving devices or the content package includes information, which allows the client to process the content according to his current conditions.</p> <p>Examples of Broadcast Services are:</p> <p>pure Broadcast Services:</p> <ul style="list-style-type: none"> - mobile TV - mobile file downloading (mobile newspaper, clips, games, SW upgrades, other applications) <p>combined broadcast/interactive Broadcast Services:</p> <ul style="list-style-type: none"> - mobile TV with file downloading and voting - betting Broadcast Services - auction Broadcast Services - trading Broadcast Services
Partially Available Transport Stream	Transport Stream of a non-SFN DVB-SH network destined to be partially transmitted on some cells or all cells where the TS is available.
Region	Group of cells where the same Regionalized TS is transmitted (i.e. where the same subset of DVB services of a Partially Available Transport Stream is available).
Regionalized TS	Transport Stream composed of a well-identified subset of the DVB services of a Partially Available Transport Stream. A Regionalized TS is what is actually transmitted on the air interface, whereas a Partially Available Transport Stream is more a distribution network entity. A Regionalized TS has same identification (original_network_id, transport_stream_id) as the parent Partially Available Transport Stream, and consequently as other sibling Regionalized TSs.
Smartcard Profile	<p>Alias for a set of Smartcard-based technologies and mechanisms which provide key establishment and key management, as well as permission and token handling for the Service and Content Protection solution for BCAST Terminals. In particular, subscriber key establishment and both short and long term key management may be based on GBA mechanisms and a Smartcard with (U)SIM/ISIM as defined by 3GPP, or based on a pre-provisioned shared secret key and a Smartcard with R-UIM/CSIM/ISIM or a UIM as defined by 3GPP2.</p> <p>The Smartcard Profile is described in [BCAST11-ServContProt] Section 6.</p>

3.3 Abbreviations

3GPP	3 rd Generation Partnership Project
BCAST	Mobile Broadcast Services
BCMCS	Broadcast Multicast Service
BCRO	Broadcast Rights Object
BDS	BCAST Distribution System
BSA	BCAST Service Application
BSD/A	BCAST Service Distribution and Adaptation
BSM	BCAST Subscription Management
CGC	Complementary Ground Component
DCF	DRM Content Format
DRM	Digital Rights Management
DVB	Digital Video Broadcasting
DVB-H	Digital Video Broadcasting – Handheld
DVB-SH	Digital Video Broadcast – Satellite to Handheld
EN	European Norm
ESG	Electronic Service Guide
ETSI	European Telecommunications Standards Institute
FDT	File Delivery Table
FEC	Forward Error Correction
FLUTE	File Delivery over Unidirectional Transport
GZIP	GNU zip
INT	IP/MAC Notification Table
IP	Internet Protocol
IPDC	IP DataCast
IPsec	IP security
ISIM	IP Multimedia Services Identity Module
ISMACryp	Internet Streaming Media Alliance (ISMA) Encryption and Authentication
KMS	Key Management System
LTKM	Long Term Key Message
MBMS	Multimedia Broadcast / Multicast Service
MIKEY	Multimedia Internet KEYing
MKI	Master Key Identifier
MPE	Multi-Protocol Encapsulation
NIT	Network Information Table
n-PSK	Phase-Shift Keying digital modulation scheme (QPSK or 8PSK or 16APSK in this specification)
OFDM	Orthogonal Frequency Division Multiple Access
OMA	Open Mobile Alliance

OSF	Open Security Framework
PAT	Program Association Table
PEK	Program Encryption Key
PID	Packet Identifier
PMT	Program Map Table
PSI/SI	Program Specific Information/Service Information
RF	Radio Frequency
RTCP	Real Time Control Protocol
SC	Satellite Component
SDP	Session Description Protocol
SDT	Service Description Table
SEK	Service Encryption Key
SF	Signalling Field
SFN	Single Frequency Network
SG	Service Guide
SG-C	Service Guide-Client
SG-D	Service Guide-Distribution
SG-D	Service Guide Generation
SGDD	Service Guide Delivery Descriptor
SGDU	Service Guide Delivery Unit
SRTP	Secure Real-time Transport Protocol
STKM	Short Term Key Message
TDM	Time-Division Multiplex
TPS	Transmission Parameter Signalling
TR	Technical Report
TS	Technical Specification
TS	Transport Stream
XML	Extensible Markup Language

4. Introduction

This technical specification specifies how the OMA Mobile Broadcast Services (BCAST) Enabler can be implemented in DVB-SH Network.

4.1 Version 1.1

BCAST ERP 1.1 has to achieve two modes of adaptation for DVB-SH:

1. Generic adaptation over an underlying DVB-SH transport network

In this mode, this Technical Specification explains how the BCAST Enabler has access to the IP transport layer so that BCAST services can be provided from BCAST Network entities to BCAST terminals. Furthermore, this allows a common behaviour across multiple BCAST enabled BCAST Distribution Systems (BDSes).

However, in generic adaptation mode, it may be impossible to share broadcast services with a native DVB-SH IPDC server / terminal due to differences between the technologies selected in the particular BDS and the generic adaptation. For example, file delivery mechanisms may be different or service and content protection mechanisms may be different. In practice this means file delivery sessions and streaming sessions are most likely to be provided in parallel in order to cater for BCAST terminals and DVB-SH IPDC terminals.

2. BDS specific adaptation to DVB-SH IPDC functionality

In this mode, this Technical Specification explains how various BCAST functionalities are adapted in a DVB-SH IPDC network taking into consideration specific technical aspects of the underlying BCAST Distribution System (BDS). In this mode, it is possible that broadcast services can be shared between BCAST terminals and DVB-SH IPDC terminals. Hence BCAST network entities and DVB-SH IPDC servers can provide services to both types of terminals.

For example, file delivery mechanisms and protection mechanisms of BCAST Enabler are adapted to be in line with those defined by IP Datacast over DVB-SH specifications as far as possible. In practice this means file delivery sessions and streaming sessions could cater for both BCAST terminals and DVB-SH IPDC terminals, without the need for providing sessions in parallel (unlike 1 above).

A consequence of adaptation to the underlying BDS functionality is that the BCAST behaviour is profiled to each BDS, making it difficult or impossible to share BCAST services across multiple BDSes.

Note that the purpose of BDS specific adaptation is to enable sharing a service between BCAST terminals and native BDS terminals. In contrast, generic adaptation allows to share a BCAST service across different BDSes. As described above, BCAST Network entities and BCAST Terminals will be able to handle the two types of adaptation, providing maximum deployment flexibility for the Service Provider. This allows BCAST terminal to work automatically in both situations, as signalling is provided to indicate to the terminal the type of adaptation provided. As BCAST Enabler is adapted to or adopts only part of the underlying BDS functionality, BCAST Enabler may be adapted to both types, i.e. BDS specific adaptation (optimised for BDS) for certain functions whilst using generic adaptation (BCAST-specific functionality) for other functions.

Chapter 5 provides an informative overview of DVB-SH and IP Datacast.

Chapter 6 provides specifications for the generic adaptation over a DVB-SH transport network.

Chapter 7 provides specifications for BDS specific adaptation to DVB-SH IPDC functionality.

Chapter 8 provides an informative walkthrough explaining how BCAST services are distributed over DVB-SH.

5. Overview of DVB-SH and IP Datacast (Informative)

5.1 System overview

DVB-SH is a delivery system enabling to carry IP-based broadcast services over a hybrid satellite and terrestrial infrastructure operating at frequencies below 3 GHz to a variety of portable, mobile and fixed terminals having compact antennas with very limited or no directivity. Target terminals include handheld defined as light-weight and battery-powered apparatus (e.g. PDAs, mobile phones), vehicle-mounted and nomadic (e.g. laptops, palmtops, etc.) terminals.

The DVB-SH system coverage is obtained by combining a Satellite Component (SC) and, where necessary, a Complementary Ground Component (CGC) to ensure service continuity in areas where the satellite alone can not provide the required QoS. The SC ensures wide area coverage while the CGC provides cellular-type coverage. All types of environment (outdoor, indoor, urban, suburban and rural) can then be served.

5.2 Configurations in scope

Depending on DVB-SH waveform, DVB-SH defines two architectures:

- SH-A for OFDM terrestrial and OFDM satellite transmission mode.
- SH-B for OFDM terrestrial and TDM satellite transmission mode.

Configurations are further detailed according to concepts such as common/local content, and hybrid/non-hybrid frequencies.

The content available on Satellite Component, and which is repeated by all Complementary Ground Components, is by convention called *common content*. For this signal repetition, the terrestrial transmitter can use:

- either the same frequency as the satellite signal (SFN case, applicable to SH-A)
- or a different frequency from the satellite signal (non SFN case, applicable to SH-A and SH-B).

In addition to this, and using a supplemental frequency, the CGC may also transmit content not available on satellite signal, which content is by convention called *local content*. Such local content insertion is only possible in the non SFN case (SH-A or SH-B).

In DVB-SH terminology:

- a *hybrid frequency* designates a frequency used to carry the common content at least, and eventually also some local content.
- A *non-hybrid frequency* designates a frequency used to carry purely local content.

DVB-SH terminals equipped with appropriate RF front-end are potentially able to receive at the same time a hybrid-frequency signal and a non-hybrid-frequency signal. This means the simultaneous reception of two Transport Streams, or at service layer level, the simultaneous tuning to two Broadcast Channels (collaborative or independent). This version of the specification however does not address such configurations involving DVB-SH transmission on non-hybrid frequencies.

Remaining DVB-SH configurations explicitly in scope are then: SH-A SFN, SH-A non SFN, SH-B non SFN, hybrid frequency in all cases. Figure 1 below illustrates these configurations:

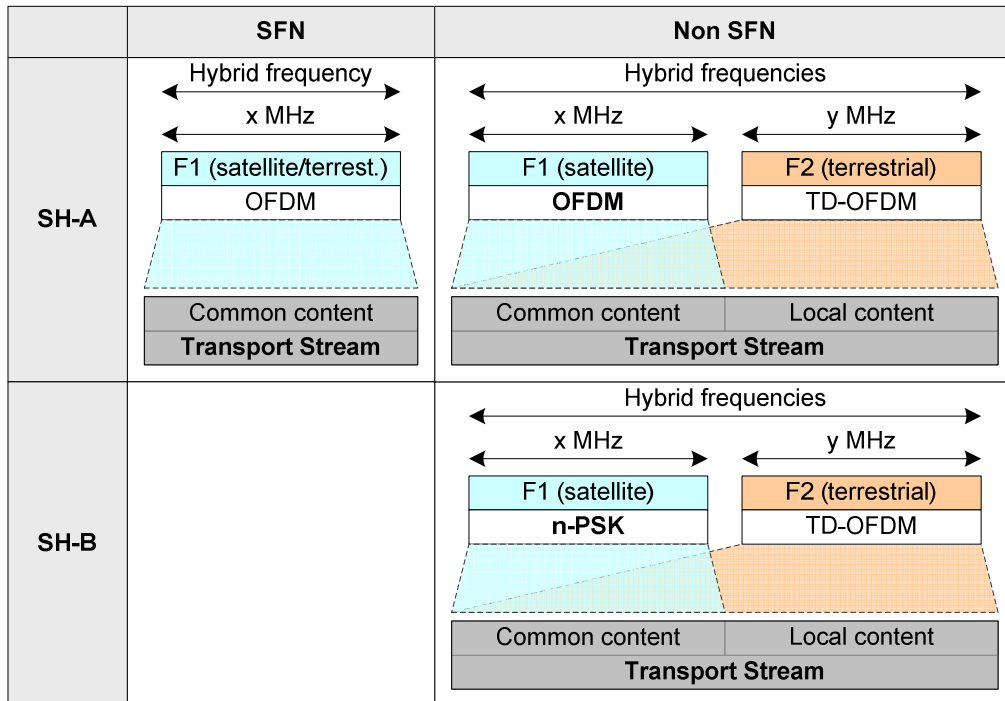

Figure 1: DVB-SH system configurations

The operation for the CGC to transmit on hybrid frequency local content in addition to common content is called *local content insertion*.

This local content insertion is not possible in SH-A SFN case, and might not always be performed in non SFN case (strict terrestrial repetition of satellite signal on another frequency). When local content insertion does not take place on a DVB-SH cell, DVB-SH reception raises no specific issue from a service layer standpoint. The role of this Adaptation specification is therefore to specifically focus on local content insertion aspects.

5.3 DVB-SH Transport Stream

DVB-SH is a purely broadcast (unidirectional) distribution system which uses MPEG-2 TS and DVB IP Datacast for IP transport and signaling..

In DVB IP Datacast, an MPEG-2 TS is composed of one or several DVB services, which themselves are grouping one or several Elementary Streams, which in turn carry the actual IP streams. In DVB-SH DVB services build up the basis of local content insertion mechanism. Note that a DVB service is a below-IP component which has no connection with above-IP services.

When no local content insertion takes place, the DVB-SH receiver handles the DVB-SH TS normally, i.e. without any specific processing like SDT parsing, IP stream availability check, etc.

When local content insertion takes places, the TS is called *Partially Available Transport Stream*. In this case:

- In the distribution network:
 - IP streams pertaining to common content are gathered in one or several DVB services, called common DVB services.
 - IP streams pertaining to local content are gathered in one or several DVB services, called local DVB services.

- The Partially Available Transport Stream exists as the composition of all common and local DVB services. It is somehow virtual in the sense that it might not be destined to be fully transmitted somewhere.
- In the SDT, and for each DVB service of the TS, a service_availability_descriptor may be included to indicate in which list of cell IDs the DVB service must be transmitted or not.
- In the transmission network:
 - Before transmission, the transmitter filters any DVB service of the TS which it not intended for transmission on the transmitter's cell_id, according to the SDT.
 - Filtering a DVB service consists in removing the TS packets of its Elementary Streams, and reconstructing PAT and PMT. The INT in the common DVB service is left untouched, meaning that all common and local IP streams are declared by the INT whether they are transmitted or not.
 - The resulting portion of the Partially Available Transport Stream actually transmitted is still a canonical TS, called *Regionalized TS*. It has the same identification as the original Partially Available Transport Stream, which is convenient to quickly perform some cases of handover.
- On the receiver side:
 - When the SH_delivery_system_descriptor indicates that the TS is a Partially Available Transport Stream, the terminal must be aware that the 'IP address → PID' resolution will not be always successful. This resolution must then use the SDT to check if the IP stream belongs to a DVB service which has really been transmitted on current cell.
 - This IP stream availability check might take some time, so it should be invoked for as less IP streams as possible. In other terms, considering on the one hand IP stream descriptors and on the other hand the IP streams themselves, the number of IP stream descriptors allowed to declare unavailable local IP streams should first be minimal, and second be known to the terminal.

To summarize, this local content insertion in DVB-SH is achieved via content removal.

In the illustrative Figure 2 below, each piece of content can be carried by distinct DVB services:

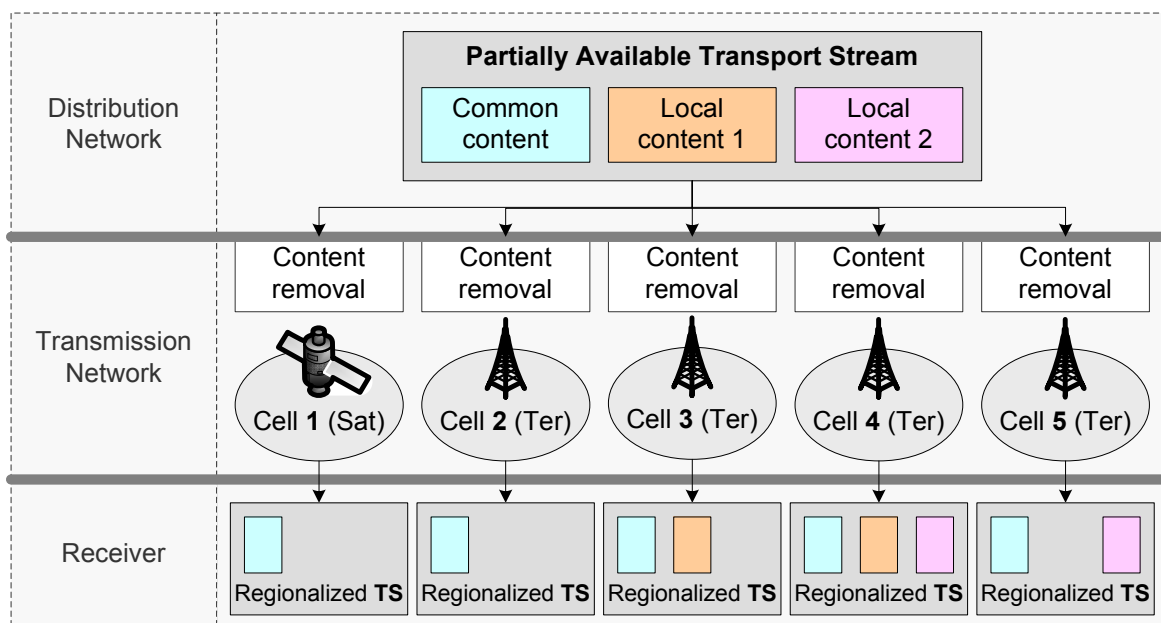

Figure 2: Local content insertion via content removal

5.4 Specifications

Use cases applicable to IPDC over DVB-SH system Phase 1 are described in [ETSI TR 102 473].

An end-to-end system architecture applicable to IPDC over DVB-SH system is described in [ETSI TR 102 469].

The following documents define the DVB-SH radio interface:

- The DVB-SH waveform is specified in [ETSI EN 302 583].
- The DVB-SH transmission system is specified in [ETSI TS 102 585].

The following documents define the DVB-SH IP transport interface:

- The DVB-SH related system level signalling, applicable both to DVB-SH IPDC network and to DVB-SH IPDC receiver is specified in [ETSI TS 102 470-2].

The following documents define the IP mobility/handover for DVB-SH:

- Mobility/handover procedures for DVB-SH are specified in [ETSI TS 102 611-2].

The following documents define the IP Datacast service layer over DVB-SH.

- The Electronic Service Guide is specified in [ETSI TS 102 471].
- The Content Delivery Protocols is specified in [ETSI TS 102 472].
- The Service Purchase and Protection is specified in [ETSI TS 102 474].
- Audio and video formats supported in IP Datacast systems over DVB-SH are specified in [ETSI TS 102 005].

6. Generic adaptation over DVB-SH IP transmission network

This Section describes how BCAST specifications (namely [BCAST11-Services], [BCAST11-SG], [BCAST11-ServContProt], [BCAST11-Distribution] and [DRM20-Broadcast-Extensions]) are used over a DVB-SH network. The provisions in this Section thus complement the ones in the generic specifications so that BCAST services can be distributed over a DVB-SH IP transmission network, without re-using the DVB-SH IPDC functionality and hence without the ability for sharing services with native DVB-SH IPDC terminals.

All normative statements in this specification are only applicable to cases where OMA BCAST services are distributed over a DVB-SH network specified in [ETSI TS 102 585].

The sentence "as defined by BCAST Enabler specifications" is a shorthand notation that indicates both BCAST server and terminal SHALL respect relevant BCAST specifications (listed above).

Generic adaptation MAY be supported by BCAST Network entities and SHALL be supported by BCAST Terminal.

6.1 Access to the IP layer

The [ETSI TS 102 470-2] specification SHALL apply.

6.2 Generic adaptation related to OMA-TS-BCAST_Services

6.2.1 Interaction

OMA BCAST enables four cases of interaction specified in Section 5.3 of [BCAST11-Services] related to Mobile Broadcast Services. In all of these cases the interaction is supported by Interactive Channel. Since DVB-SH is purely a unidirectional bearer and does not include a logical Interactive Channel itself, any bi-directional mobile system can be used as Interactive Channel with DVB-SH. Therefore these four cases of interaction are directly applicable when DVB-SH is the BDS, i.e., a terminal with access to an interactive channel SHALL support all of these four cases of interaction.

The specification in section 5.3 of [BCAST11-Services] SHALL apply.

6.2.2 Service Provisioning

The specification in section 5.1 of [BCAST11-Services] SHALL apply.

6.2.3 Terminal Provisioning

The specification in section 5.2 of [BCAST11-Services] SHALL apply.

Overriding the "status" definitions in [BCAST11-Services] Appendix F, terminal support for the <IPDC-SH> node of the BCAST Management Object and its sub-nodes is defined as follows:

Node	Status
<X>/BDSEntryPoint/<X>/IPDC-SH	Required
<X>/BDSEntryPoint/<X>/IPDC-SH/<X>	Required
<X>/BDSEntryPoint/<X>/IPDC-SH/<X>/Tuning	Optional
<X>/BDSEntryPoint/<X>/IPDC-SH/<X>/Tuning/Frequency	Required
<X>/BDSEntryPoint/<X>/IPDC-SH/<X>/Tuning/UseLPChannel	Required
<X>/BDSEntryPoint/<X>/IPDC-SH/<X>/Tuning/Complementary	Required
<X>/BDSEntryPoint/<X>/IPDC-SH/<X>/Tuning/Complementary/HybridFrequency	Required
<X>/BDSEntryPoint/<X>/IPDC-SH/<X>/Tuning/Complementary/UseLPChannel	Required
<X>/BDSEntryPoint/<X>/IPDC-SH/<X>/IPPlatformID	Required

<X>/BDSEntryPoint/<X>/IPDC-SH/<X>/DVBNetworkID	Required
<X>/BDSEntryPoint/<X>/IPDC-SH/<X>/ESGProviderID	Required

Table 1: BCAST Management Object and its sub-nodes

6.2.4 Notification

The specification in Section 5.14 of [BCAST11-Services] SHALL apply.

When using IPDC over DVB-SH as the underlying BCAST Distribution System the Notification functionality is enabled as specified in [BCAST11-Services].

6.3 Generic adaptation related to OMA-TS-BCAST_ServiceGuide

6.3.1 Service Guide Delivery over Broadcast Channel

The provisions relevant to Service Guide delivery over Broadcast Channel in section 5.4.2 of [BCAST11-SG] SHALL apply, with the following extension: the Genre definition as specified in section 6.3.4.2 also applies to the GenreGroupingCriteria element in the SGDD.

6.3.2 Compression of Service Guide Delivery Units

The specification in section 5.4.1.4 of [BCAST11-SG] SHALL apply.

6.3.3 Session Description

The general provisions of specification in section 5.1.2.5 of [BCAST11-SG] SHALL apply with the modifications as detailed in the following sections.

6.3.3.1 SessionDescription for broadcast streamed media sessions

The SessionDescription SHALL provide the following parameters:

- The sender IP address
- List of media components in the session
- Initial buffering delay, using the ‘min-buffer-time’ attribute as specified in [ETSI 102 472] section 5.3.4.

The terminal MAY ignore the following parameters in the SessionDescription if they are present, as they are either not required or out of scope of IPDC over DVB-SH BDS:

- FEC configuration and related parameters
- The mode of MBMS bearer per media

For all parameters composing the SessionDescription, rules defined in [ETSI TS 102 472] Section 5.2 SHALL apply.

6.3.3.2 SessionDescription for broadcast file delivery sessions

The specification in section 5.1.2.5.3 of [BCAST11-SG] SHALL apply.

Furthermore, Session Description is modified considering the characteristics of IPDC over DVB-SH, as explained below.

The SessionDescription MAY provide the following parameters:

- FEC capabilities and related parameters
- Media type(s) (i.e. “application”) and fmt-list (i.e. “0”)
- Service language(s) per media
- Data rates using SDP bandwidth modifiers

The terminal MAY ignore the mode of MBMS bearer per media in the SessionDescription, as this parameter is out of the scope of IPDC over DVB-SH.

For all parameters composing the SessionDescription, rules defined in [ETSI TS 102 472] Section 6.1.13 SHALL apply.

6.3.4 Service Guide Data Model

The specification in section 5.1 of [BCAST11-SG] SHALL apply.

6.3.4.1 CellTargetArea in DVB-SH

Underlying DVB-SH functionality is re-used, as explained below.

OMA BCAST Service Guide allows describing the target area for Service and Content in terms of BDS-specific cell identification or DVB service ID identification in the “CellTargetArea” element.

OMA BCAST Service Guide allows terminal to request specific SGs based upon its BDSLocationID in terms of BDS-specific cell identification.

In the case of DVB-SH, the value of the “CellArea” sub-element element of the “CellTargetArea” element and BDSLocationID utilized by terminal to request specific SGs as specified in section 5.4.3.4 in [BCAST11-SG] is composed from the parameters described in subsequent sub-sections. Each parameter is signalled by an uppercase alpha character, immediately followed by a string of lowercase alphanumeric characters representing the value of a parameter, and immediately followed by the next parameter, if any, as defined in the table below. The parameters MUST be given in the order of appearance in the tables below. All parameters defined below SHALL be supported by the Terminal. The Server SHALL support parameters with a cardinality of 1 or more and MAY support the remaining parameters.

DVB-SH CellTargetArea in Service and/or Content fragments SHALL NOT be instantiated to describe the target area of common BCAST services (as they are by essence available everywhere), and SHALL always be instantiated to describe the restrictive target area of local BCAST services (as it is critical for the terminal to not attempt to tune to local BCAST services not available on current cell).

DVB-SH CellTargetAreas of different types (namely 12 and 16, see sub-sections below) MAY coexist in the same SG BroadcastArea.

6.3.4.1.1 CellArea/BDSLocationID based on Cell ID

When “BDSType” as specified in section 5.4.3.4 in [BCAST11-SG] or “type” attribute of CellTargetArea element is set to value 12 (DVB-SH Cell ID), the value of each “CellArea” element and BDSLocationID is composed from the following parameters:

Parameter name	Signalling	Value	Length [bytes]	Cardinality	Description
network_id	“N”	Hexadecimal representation of a 16bit unsigned integer	4	0..1	“network_id”, transmitted in the Network Information Table (NIT) according to [ETSI EN 300 468]. This parameter SHALL be omitted if the DVB-SH network conforms to cell id allocation recommendation given in [ETSI TS 102 611-2].
cell_id	“C”	Hexadecimal representation of a 16bit unsigned integer	4	1	“cell_id”, transmitted in the DVB-SH signal according to [ETSI EN 302 583], either in the TPS bits for the OFDM mode or in the Signalling Field

					for the TDM mode.
hierarchy	“H”	“lp” or “hp” – other values are reserved	2	0..1	The logical channel (“lp” for “low priority” or “hp” for “high priority”) that is selected for reception when hierarchical modulation is used.
subcell_id	“S”	Hexadecimal representation of an 8bit unsigned integer	2 per entry	0..N	subcell id, transmitted as "cell_id_extension" in the Network Information Table (NIT) according to [ETSI EN 300 468].

Examples (informative):

- The string "C005aHlp" represents a target area defined by a cell_id of 0x005a and the use of the "lp" channel of hierarchical modulation. The subcell_id is not present.
- The string "C005aS01S02" represents a target area defined by a cell_id of 0x005a, and a list of two subcell_id (0x01 and 0x02).

6.3.4.1.2 CellArea based on DVB service ID

A DVB-SH Partially Available Transport Stream is composed of DVB services either transmitted or filtered on a given cell. To support this feature, each DVB service entry of the SDT may include a service_availability descriptor containing an availability_flag as well as the list of cell IDs where the DVB service must be transmitted (or not transmitted, according to availability_flag).

So somehow in DVB-SH, a DVB service ID is not just a transport identifier, but it also identifies a broadcast area on which the same IP streams are transmitted. It can therefore be used to construct BCAST Cell Target Areas, as an alternative to BCAST Cell Target Areas composed of DVB-SH Cell IDs. A method to select the proper type of Cell Target Area is as follows:

- Cell Target Areas listing DVB-SH DVB service IDs SHOULD be preferred when regions are composed of a great number of cells, or when the list of cells defining regions are subject to frequent changes.
- Cell Target Areas listing DVB-SH Cell IDs SHOULD be preferred when the network entity generating the SG Broadcast Area (SG-G, SG-D...) has no knowledge of DVB service numbering in DVB-SH TS structure, or when this numbering is subject to frequent changes, or when the granularity of target area is smaller than a region (i.e. a subset of cells in a region).

When “type” attribute of CellTargetArea element is set to the value 16 (DVB-SH DVB service ID), the value of each “CellArea” element is composed from the following parameters:

Parameter name	Signalling	Value	Length [bytes]	Cardinality	Description
original_network_id	“O”	Hexadecimal representation of a 16bit unsigned integer	4	1	“original_network_id”, transmitted in the Network Information Table (NIT) according to [ETSI EN 300 468].
transport_stream_id	“T”	Hexadecimal representation of a 16bit unsigned integer	4	1	“transport_stream_id”, transmitted in the Network Information Table (NIT) as well as in the Program Association Table (PAT) according to [ETSI EN 300 468].
service_id	“V”	Hexadecimal representation	4	1	“service_id”, transmitted in the

		of a 16bit unsigned integer			Network Information Table (NIT) as well as in the Program Association Table (PAT) according to [ETSI EN 300 468] – in the latter case, it is named ‘program_number’.
--	--	-----------------------------	--	--	--

A CellTargetArea of type 16 with “polarity” attribute of enclosing BroadcastArea element set to True:

- SHALL contain one or more CellArea elements each listing a local DVB service ID
- SHALL NOT contain a CellArea element listing a common DVB service ID, as this would signal a “everywhere” target area, contradicting the restrictive semantics of BroadcastArea functionality.

A CellTargetArea of type 16 with “polarity” of upper BroadcastArea element set to False:

- MAY contain a CellArea element listing common DVB service ID, to signal the target area of some local BCAST services transmitted on all terrestrial cells but not on satellite cell
- MAY contain CellArea elements listing local DVB service IDs, when common DVB service ID is besides also listed.

Example (informative):

- The string "OC0T05VF1" represents a target area corresponding to the area of transmission of a DVB service ID fully identified by original_network_id = 0xC0, transport_stream_id = 0x05 and service_id = 0xF1.

6.3.4.2 Genre Definition

BCAST terminals supporting the IPDC over DVB-SH BDS

- SHOULD support the “type” and “href” attributes of the Genre elements
- SHOULD support levels 1 to 4 of the TV Anytime ContentCS classification scheme identified by urn:tva:metadata:cs:ContentCS:2005 as defined in Annex A.8 of [TVA-Metadata], for values “main” and “secondary” of the “type” attribute
- SHOULD support level 1 to 3 of the TV Anytime IntendedAudienceCS classification scheme identified by urn:tva:metadata:cs:IntendedAudienceCS:2005 as defined in Annex A.11 of [TVA-Metadata], for the value “other” of the “type” attribute.

6.3.4.3 BDSSpecificEntryPointInfo definition

Section 5.4.1.5.2 of [BCAST11-SG] specifies how SGDDs can include the definition of SGEEntryPoints over BCAST BDS broadcast channels. Each broadcast SGEEntryPoint (i.e. SG Announcement Channel) in a BCAST BDS is declared partially by generic parameters (such as ‘srcIpAddress’, ‘port’, etc.) and partially by BDS-specific parameters, provided in each BDS Adaptation TS via the extension by derivation of the abstract type of BDSSpecificEntryPointInfo element.

For the DVB-SH BDS, the abstract type of BDSSpecificEntryPointInfo element is derived as follows:

Name	Type	Category	Cardinality	Description	Data Type
BDSSpecificEntryPointInfo	E5	NM/TM	0..1	The placeholder for the supplementary information that is required in order to retrieve the broadcast SG entry point in BCAST BDS, i.e. in	complexType deriving from abstract type

				DVB-SH BDS for the present specification.	of BDSSpecificE ntryPointInfo element
frequency	E6	NM/TM	1..N	Center frequency in kHz of the primary DVB-SH signal to tune to. This element MAY be instantiated multiple times in the case where the Transport Stream carrying the SG Announcement Channel is transmitted over different frequencies (same TS available on different cells).	unsignedInt
useLPChannel	E6	NM/TM	0..1	When DVB-SH hierarchical modulation is used, present and set to True to signal the use of LP channel, or present and set to False to signal the use of HP channel.	boolean
IPplatformID	E6	NM/TM	1	Identifies the IP platform which the IP flow 'SG Announcement Channel' belongs to.	unsignedInt
networkID	A	NM/TM	0..1	When the IP Platform ID is not globally unique, identifies the DVB Network scoping the IP Platform ID value.	unsignedShort

6.3.5 Service Guide Discovery

Service Guide discovery in DVB-SH networks SHALL be realized using DVB-SH IPDC standards, as explained below.

Except for the mechanism of discovering the Service Guide entry point specified in this Adaptation Specification, the specification in section 6 of [BCAST11-SG] SHALL apply.

The network provides PSI/SI information as specified in [ETSI TS 102 470-2]. The terminal MAY use PSI/SI information to find out if there is an ESG bootstrap session on an IP Platform by checking whether the INT signals the IP multicast address reserved for ESG bootstrapping according to Section 9.2 of [ETSI TS 102 471]. It is assumed that there is an ESG bootstrap session where Service Guides are described with ESGProviderDiscovery Descriptors, as specified in Section 9 of [ETSI 102 471]. This also applies to describing OMA BCAST Service Guides.

The ESG bootstrap session SHALL be a FLUTE session as specified in [ETSI TS 102 471]. If bootstrap is used to signal an OMA BCAST Service Guide, then the bootstrap SHALL contain the description as specified in Section 6.3.5.1.1 below. There MAY be more than one OMA BCAST compliant Service Guide on an IP Platform.

The terminal SHALL be able to receive the ESG bootstrap session and process the contents (i.e. ESGProviderDiscovery descriptors and ESGAccessDescriptors) with the additions and changes described in this document.

In case there is no ESG bootstrap session, the existence of an OMA BCAST compliant Service Guide MAY be signalled otherwise. However, this is out of scope of BCAST.

6.3.5.1 Bootstrap descriptors

The following sections specify the ESGProviderDiscovery Descriptor and ESGAccessDescriptor that are used within the bootstrap session to allow the discovery of the provider of the service guide and the access to the service guide. In both cases, underlying DVB-SH IPDC functionality is re-used as explained below.

6.3.5.1.1 ESGProviderDiscovery Descriptor

An ESGProviderDiscovery Descriptor (see section 9.1.1 of [ETSI 102 471]) which references a Service Guide conforming to OMA BCAST 1.1:

- SHALL be of version 1, signalled in the FDT by the MIME type “text/xml”. The terminal SHALL consider ESGProviderDiscovery Descriptors of other versions or MIME types being not compliant with OMA BCAST.
- SHALL have the attribute “format” of the ServiceProvider entry referencing the BCAST Service Guide set to the string ”urn:oma:xml:bcast:sg:fragments:1.1”. The terminal SHALL consider ServiceProvider entries without this attribute or with this “format” attribute having a different value being not compliant with OMA BCAST 1.1.

6.3.5.1.2 ESGAccessDescriptor

ESGAccessDescriptor gives the access information to the ESG sessions as specified in Section 9.1.2 of [ETSI TS 102 471].

In the ESGAccessDescriptor, ESG entries SHALL all be of version 1.

In addition, the field “MultipleStreamTransport” in the ESGAccessDescriptor has no meaning in this specification. Thus, it is reserved and SHALL be set to 0.

An OMA BCAST compliant ESGAccessDescriptor file is signalled in the FDT of the ESG bootstrap FLUTE session by setting the attribute Content-Type=”application/vnd.oma.bcast.sgboot”.

The session accessible with ESGAccessDescriptor SHALL be a Service Guide Announcement Channel as described in [BCAST11-SG].

6.3.5.2 Regionalized Service Guide

Section 6.3.5.1 is extended by this section in the case of DVB-SH regionalized Service Guide.

In this specification, a regionalized Service Guide designates a Service Guide partially delivered on some areas. The terminal acquires fragments of this Service Guide from one cell to another, and aggregates these fragments to complete the Service Guide instance. It is intended that fragments of a regionalized Service Guide acquired at some point in time by the terminal always builds a consistent subset.

A regionalized Service Guide can only be carried by a Partially Available Transport Stream (which has the inherent capability to be partially transmitted). In this regionalized Service Guide, some fragments will declare common BCAST services (available on all cells where the TS is transmitted) whereas other fragments will declare local BCAST services (available on some terrestrial cells only).

The ESG bootstrap session is necessarily carried by a common DVB service (fixed IP multicast address, always available). On the other hand when local content insertion applies, local SG Delivery sessions are carried by local DVB services that might not be transmitted in the Regionalized TS. The IP stream declaration chain “ESGentry → SG Announcement Channel; SGDD → SG Delivery Channel” is then cut somewhere. This specification defines this cut between the ESGentry of Access descriptor, and the Service Guide Announcement Channel, in order to minimize the number of IP stream availability check.

Multiple SG Announcement Channels

In the Partially Available Transport Stream (in the distribution network), multiple synchronized Service Guide Announcement Channels are instantiated for the same Service Guide. In this case, the following applies:

- The common SG Announcement Channel SHALL be carried by a common DVB service (transmitted everywhere).
- Each local SG Announcement Channel SHALL be carried by a distinct local DVB service.
- One local SG Announcement Channel at most SHALL be transmitted.
- The common SG Announcement Channel SHALL only carry SGDDs declaring SG Delivery Channels carried by common DVB Service.
- A local SG Announcement Channel MAY carry SGDDs declaring local SG Delivery Channels carried by same local DVB Service
- A local SG Announcement Channel SHALL carry SGDDs declaring all the SG Delivery Channels carried by common DVB services (meaning that common and local SGDDs will at the same time declare the same common

SG Delivery Channels). In other words monitoring any local SG Announcement Channel must be equivalent at least to monitoring the common SG Announcement Channel.

- A local SG Announcement Channel MAY also carry SGDDs already carried by common SG Announcement Channel. This enables continuous acquisition of common SGDDs on all cells.
- A local SG Announcement Channel SHALL NOT carry SGDDs declaring SG Delivery Channels transported by local DVB services not transmitted along with the local SG Announcement Channel.

Multiple ESG entries in ESG Access descriptor

The multiple instantiations of SG Announcement Channels (and also the indication of regionalized SG) is signalled to the terminal in the ESG Access descriptor:

- In the ESG Access descriptor, there SHALL be one ESGEntry per SG Announcement Channel instantiated for the Service Guide. Note: this occurrence is allowed by [ETSI TS 102 471] although only one ESGEntry is commonly instantiated for DVB IPDC.
- All ESGEntries (containing the concerned ProviderID) SHALL appear in a continuous sequence in the ESGEntry loop.
- The first ESG entry SHALL declare the common SG Announcement Channel. The subsequent entries SHALL declare local SG Announcement Channels.
- For each ESGEntry associated to the ProviderID, the terminal SHALL check the IP stream availability of the corresponding SG Announcement Channel.
- If two Service Guide Announcement Channels are transmitted, the terminal SHALL tune to the second one (a local SG Announcement Channel) in the order of appearance in the ESGEntry loop to proceed to further Service Guide acquisition.
- If one Service Guide Announcement Channel is transmitted, the terminal SHALL tune to this one (the common SG Announcement Channel) to proceed to further Service Guide acquisition.

Notes:

- These rules and behaviors are compatible with the ones defined for IPDC over DVB-SH (see [ETSI TS 102 592-2])
- For the terminal, the sole additional task (when compared with the traditional case of non-regionalized Service Guide) is to select the proper SG Announcement Channel. Once done, SG acquisition can proceed as usual. Especially, the terminal is not aware of advanced mechanisms like cross-referencing the same SG Delivery Channels via SGDDs delivered in different DVB services. The complexity somehow resides on ESG provider side.
- The IP stream availability check (which needs INT and SDT) might be provided by a low-level function to the service layer. It is of same level as the one returning the current cell ID (which needs NIT and TPS bits/SF).

Informative example

Figure 3 below illustrates the case of one Partially Available Transport Stream composed of three DVB services (1 common and 2 local). On the current cell, DVB service 2 is filtered and DVB services 0 and 1 are transmitted. Since multiple ESGEntries appear in the Access descriptor, the terminal knows that the SG is regionalized, and that SG Announcement Channel selection needs an extra step. Using INT and SDT, it will find out that two SG Announcement Channels are transmitted. It will then tune to the local SG Announcement Channel 1 as appearing second of the transmitted in the ESG Entry loop. From this point, the terminal proceeds to SG acquisition as described in [BCAST11-SG].

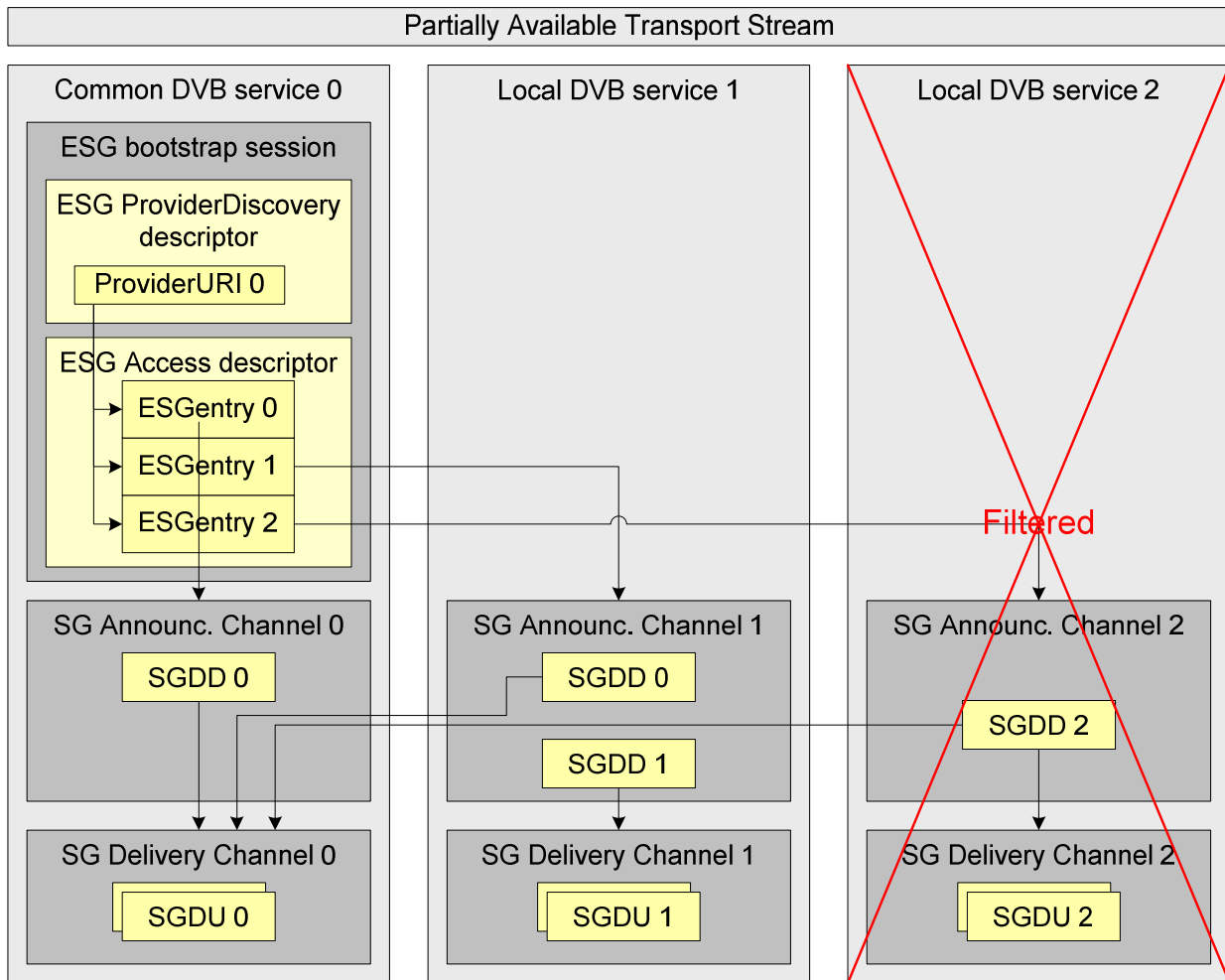

Figure 3: Example of relationships between bootstrap sessions and descriptors

The figure also illustrates two ways of instantiating SGDDs:

- The local SG Announcement Channel 1 duplicates the SGDD 0 already carried in common SG Announcement Channel
- The local SG Announcement Channel 2 follows a different strategy: SGDD2 declares at the same time common SG Delivery Channels and local SG Delivery Channels.

In any case, common SG Delivery Channels must be declared somehow from local SG Announcement Channels.

6.4 Generic adaptation related to OMA-TS-BCAST_SvcCntProtection and OMA-TS-DRM-XBS

The provisions in the two specifications [BCAST11-ServContProt] and [DRM20-Broadcast-Extensions] SHALL apply.

For the Smartcard Profile, only the Session Description Method for Acquiring SEK/PEK as defined in section 6.10.1.2 of [BCAST10-ServContProt] SHALL be used to provide the entry point to the BSM.

6.5 Generic adaptation related to OMA-TS-BCAST-Distribution

6.5.1 File Distribution

The specification in section 5.2 of [BCAST11-Distribution] SHALL apply.

Note: The interface between BSD/A and DVB-SH IPDC network entity. i.e., FD-B1 is not defined in BCAST 1.1 Enabler because DVB-SH IPDC does not specify the external interface between DVB-SH IPDC network entities and 3rd party entity.

In addition the following SHALL apply as specified in [ETSI TS 102 472]

- Terminals SHALL support interpretation of source packets constructed according to the source packet construction and reception component of the Raptor FEC Scheme for the case where there is a single sub-block (i.e. N=1).
- Terminals MAY support the Repair packet construction and Raptor FEC decoding component of the Raptor FEC Scheme.

6.5.2 Associated Delivery Procedures

The specification in section 5.3 of [BCAST11-Distribution] SHALL apply.

6.5.3 Stream Distribution

The specification in section 6 of [BCAST11-Distribution] SHALL apply.

FEC RAPTOR scheme (FEC encoding ID 1) is not supported for Stream Distribution.

Note: The interface between BSD/A and DVB-SH IPDC network entity. i.e. SD-B1 is not defined in BCAST 1.1 Enabler because DVB-SH IPDC does not specify the external interface between DVB-SH IPDC network entities and 3rd party entity.

6.5.3.1 Buffer control

Due to the use of time-slicing, buffer control is required to enable the delivery of BCAST services over a DVB-SH network.

Both the BDS Service Distribution and the Terminal SHALL support the Hypothetical Receiver Buffering Model as specified in [ETSI TS 102 472], Section 5.3.

6.5.4 Media codecs

The Terminal SHALL be able to receive, decode and render the codecs and payload types that are MANDATORY according to Annex B of [ETSI TS 102 005].

The Terminal SHOULD be able to receive, decode and render the codecs and payload types that are RECOMMENDED according to Annex B of [ETSI TS 102 005].

The Terminal MAY be able to receive, decode and render the codecs and payload types that are OPTIONAL according to Annex B of [ETSI TS 102 005].

7. BDS specific adaptation to DVB-SH IPDC functionality

The BDS-specific adaptation to DVB-SH IPDC functionality is out of scope of BCAST 1.1.

8. Walkthrough: Distribution of BCAST Services over DVB-SH (Informative)

This section describes a walkthrough of all actions needed to receive a BCAST service distributed over DVB-SH. It just describes the main actions and using selected functions and features. Not all possible options and variations are described here.

8.1 Power up, Network Attachment, Initial Procedures

Tuning to DVB-SH frequency

When the receiver is powered up or enters a new network the receiver has to tune into the right frequency. This frequency can be either pre-provisioned or provisioned according to mechanisms described in [BCAST11-Services]. If the frequency is not provisioned at all, the terminal performs a signal scan. DVB-SH signals carry Time Slicing parameters. During the scan the receiver tests a frequency, tries to lock to the signal and when locked, inspects the Time Slicing indicator from TPS bits in the signal. If this is not available, the receiver discards the signal and proceeds to next one. Once a signal with Time Slicing Indicator is found the terminal looks up the network information in the signal (NIT table, see below). This table carries the lists of frequencies for the current network. When the terminal has performed a full signal scan the terminal has gathered all frequency information from the NIT tables and can now tune into any DVB-SH signal.

Identification of current Cell ID

The terminal can retrieve the Cell ID of current cell from the TPS bits (in OFDM transmission mode) or Signalling Field (in TDM transmission mode).

Generalities on MPEG-2 TS in DVB IP Datacast

An MPEG-2 Transport Stream is composed of *elementary streams* of audio, video and/or data logically grouped in *DVB services* (also called *programs* in MPEG-2 terminology). Each DVB service is described by a Program Map Table (PMT) which provides the PID of each elementary stream of the DVB service. The Program Association Table (PAT), unique in the TS, provides the PID of each PMT in the TS.

MPEG-2 Transport Streams are made up of TS packets of 188 bytes. Each packet is identified by its PID (Packet Identifier) value in the header of the packet. Packets of same PID carry a portion of same information, like a PSI table or a SI table or an elementary stream. Some PID values are fixed and identify TS packets carrying well-known PSI tables (PAT 0x0000...) or SI tables (NIT 0x0010, SDT 0x0011...) – these tables can therefore be quickly accessed in the tuning phase. Some PID values are in a ‘variable’ range and identify TS packets carrying elementary streams transporting PSI tables (PMT) or SI tables (INT) or IP streams.

Figure below illustrates how a terminal can retrieve the TS packets of an elementary stream, starting from PAT:

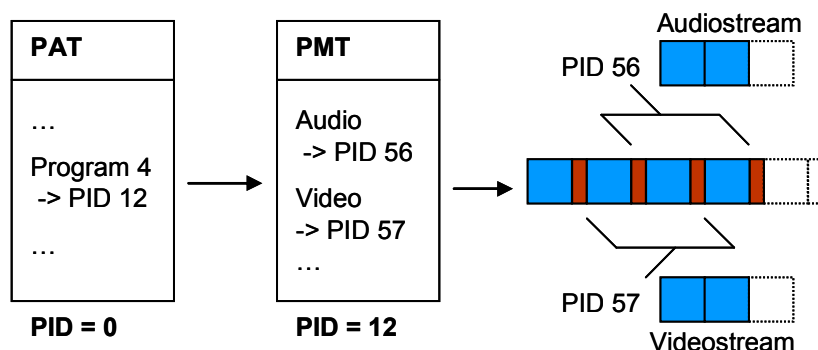

Figure 4: Illustration of the function of PAT and PMT tables in MPEG-2 TS

PSI tables (PAT, PMT...) originate from MPEG-2 TS, whereas SI tables (NIT, SDT, INT...) complement PSI tables and originate from DVB. A table is more precisely a set of independent sub-tables and each sub-table is identified by tuples (for NIT: table_id and network_id; for INT: table_id and platform_id; for SDT: table_id, transport_stream_id and original_network_id, etc.). Table_id (the first byte of a TS packet payload) allows some refinements: for instance table_id 0x40 designates the NIT_actual sub-table describing current network, whereas table_id 0x41 designates a NIT_other sub-table describing some neighbouring network.

Identification of current Transport Stream

Knowing the frequency and the current Cell ID, the terminal can further determine the identification of the actual Transport Stream (original_network_id, transport_stream_id):

- In the PAT (PID 0x0000), the terminal can read the transport_stream_id
- In the NIT_actual sub-table (PID 0x0010, table_id 0x40), the terminal can parse the entries of the TS loop matching this transport_stream_id. For these entries, the terminal can find an entry for which cell_frequency_link_descriptor matches both cell_id and frequency, and for which the system_delivery_descriptor is besides a SH_delivery_system_descriptor. The terminal then concludes that the original_network_id of this TS loop entry is the one of actual TS.

Identification of eventually filtered DVB services

By reading diversity_mode in SH_delivery_system_descriptor, the terminal can know if the actual TS is a full TS or a Partially Available TS. In the latter case, the terminal needs to retrieve the SDT_actual sub-table (PID 0x0011, table_id 0x42) and parse each entry of the DVB service loop. When a service entry contains a service_availability_descriptor, the corresponding DVB service might be subject to filtering on current cell, and this final determination is described in [ETSI TS 102 470-2] section "Service availability of the actual TS on the current cell".

Retrieval of the INT sub-table of a given IP platform

(Note: this part is generic to IP Datacast systems and contains no DVB-SH specifics).

Knowing the IP platform over which the service provider operates (platform_id parameter typically pre-provisioned in the terminal), the terminal can retrieve the corresponding INT sub-table as follows:

- In first loop of NIT_actual, the terminal can parse all the linkage_descriptors of linkage_type 0x0B, either given directly in the NIT, or provided indirectly in the Bouquet Association Table pointed by a linkage_descriptor of linkage_type 0x0C in the NIT.
- Among these linkage_descriptors of linkage_type 0x0B, there should be one listing the wanted platform_id. The terminal can then take note of the service_id of this descriptor, as it indicates the DVB service carrying the INT sub-table.
- Reading through the PAT, the terminal can get the entry for which program_number is equal to service_id obtained previously. This entry gives the program number PID of the PMT describing the DVB service carrying the INT sub-table.
- Knowing its PID, the terminal can then retrieve the PMT, and identify the entries for which stream_type is equal to 0x05 (=INT sub-table for IPDC) and data_broadcast_id_descriptor with data_broadcast_id set to 0x000B (IP/MAC Notification Info). Each of these entries gives the elementary PID of a INT sub-table. There can be multiple entries matching, as it is possible to carry multiple INT sub-tables (each belonging to a different IP platform) in the same DVB service.
- The terminal can then retrieve each indicated INT sub-table. There will be one of these for which platform_id parameter will match the Platform ID of interest.

Once the terminal has retrieved the INT of wanted IP platform, it is able to resolve the mapping from IP address to PID, and tune to each transmitted IP stream of this IP platform, starting from ESG bootstrap FLUTE session as explained in next section.

IP stream location resolution (from an IP flow to the elementary stream PID)

(Note: unless otherwise specified, this part is generic to IP Datacast systems and contains no DVB-SH specifics).

Given an IP flow (characterized by IP platform, IP source address, IP destination address), the terminal can proceed to the resolution of corresponding IP stream location in current TS as follows:

- It retrieves the INT sub-table of this IP platform.
- It goes through the entries of target descriptor loop to find any target descriptor (like target_IP_address_descriptor) matching the addresses of the IP flow.
- When a target descriptor is found, it parses the IP/MAC stream_location_descriptors in the subsequent operational descriptor loop, and identifies those matching network_id of NIT_actual, and matching original_network_id and transport_stream_id of actual TS. This descriptor gives as remaining parameters: service_id and component_tag.
- (Sole step specific to DVB-SH) The terminal then compares this service_id with the list of DVB service IDs – if any - known by the terminal as filtered for this TS on current cell. If the DVB service of this IP stream has been filtered, then the resolution is aborted by the terminal (as the elementary stream carrying the IP stream has not been transmitted on this cell).
- Knowing service_id and component_tag of the IP stream, the terminal parses the PAT and finds the entry for which program_number equals service_id. This entry gives the PID of the PMT describing the Elementary Streams of this DVB service.
- In the PMT, the terminal finds the entry with stream_type equal to 0x90 (IP streams for IPDC) and also for which the stream_identifier_descriptor contains a matching component_tag. This entry provides the PID of the Elementary Stream carrying the IP stream.
- The terminal retrieves the packets identified by this PID, decodes the MPE sections, and identifies the IP datagrams of the IP flow using IP source and destination address, amongst IP datagrams of other IP streams eventually carried in same Elementary Stream.

8.2 Service Guide Bootstrapping

Once the INT sub-table of the wanted IP platform is known by the terminal it can start receiving the Service Guide over broadcast channel. In order to do this it needs the SG entry point. This is the IP destination address of the IP flow which contains SG bootstrapping data. This SG entry point can be pre-provisioned or provisioned according to mechanisms described in the terminal provision function of the Services specification [BCAST11 Services].

8.3 Service Guide Reception and Update

The service guide provides the end-user with the information about all available services. The service guide consists of user readable data. The user can make a selection based on this data. When a user selects a service, it basically tells the terminal to tune into a certain IP flow, for which the terminal has to select the appropriate IP stream.

This step describes how the service guide is received and how updates are received. This step assures that the terminal has the correct information:

- about how to access the service (IP flow addresses, SDP information, service protection information etc)
- about the service itself form user presentation (title, language, length, start and end-time, price etc.)

The SG data is carried in SGDUs. Each SGDU is announced in a Descriptor Entry. A Descriptor Entry is carried inside the SGDD. The SGDD is the 'root' of the SG. There can be several SGDDs for the service guide, e.g. one which only carries the data of the next 2 hours, one which carries the SG of the day and one for the whole week. The terminal only collects those SGDUs, which belong to his service provider. For this purpose the Descriptor Entry carries a BSMSSelector in the Grouping criteria.

When certain portions of the ESG are not valid anymore, the terminal has the option to keep them for a while or throw them away.

8.4 Service Ordering

When the user received the service guide it can select a service it wishes to use. Before the user can use a broadcast service it needs to subscribe to this service. The services which do not require subscription are excluded. Such services are indicated by the omission of an associated Purchase Data fragment or which do have a purchase data fragment but the price is set to zero. Subscription basically means that the terminal receives the key to decrypt the service. The user can subscribe to items listed in the PurchaseItems of the service guide. The PurchaseData informs the user what the prices and conditions for use are. The PurchaseChannel gives the user the location where subscriptions can be requested via the return channel.

Upon user's subscription request the terminal sends a Service Request to the PurchaseURL. In the case of DRM profile, the terminal will receive in the Service Response a ROAP RO acquisition trigger allowing further acquisition of the Rights Objects wrapping the service key. In the case of Smartcard profile, the terminal will receive the service key in the Service Response itself, or shortly after over UDP.

Another option is that the user starts an acquisition procedure through the webshop. This is typically the portal of the service provider, where the user can select the items they want to subscribe to, while not being formally authenticated (during the phase of purchase item selection). When the user completed filling the shopping basket the subscription process is completed by using a method specific to each service protection profile.

When this procedure is finalized, the terminal will be in possession of the service key required to decrypt the traffic.

8.5 Service Reception

8.5.1 Streaming Service

Streaming services like TV channels are delivered to the terminal as video and audio over RTP/UDP/IP. When the user selects a service the SG provides the terminal with required information to access the IP flow. The terminal first verifies in its internal database whether the user has subscribed himself to this service. If so, the terminal knows it has the required service key to decrypt the content.

The correct IP stream is found by the terminal using the INT through the IP stream location resolution described earlier. In a typical scenario a single TV channel has one IP stream for each of its components: video, audio (multiple languages) and several key streams (for each service protection profile and for each service provider). The SDP parameters give the terminal the encoding type and format of the components of a service.

Streams can be delivered unprotected (clear-to-air), protected at the IP layer, at the RTP layer or at the Access Unit layer.

8.5.2 Download Service

Receiving download services are basically the same as streaming services. However, files are delivered over FLUTE/ALC/UDP/IP. Files can be delivered either unprotected, protected at the IP layer or as OMA DRM type of files (DCF or PDCF).

Appendix A. Change History (Informative)

A.1 Approved Version History

Reference	Date	Description
n/a	n/a	No prior version

A.2 Draft/Candidate Version 1_1 History

Document Identifier	Date	Sections	Description	
Draft Versions OMA-TS-BCAST_DVBSH_Adaptation-V1_1	15 Jul 2008	All	Initial draft, duplicating and modifying OMA-TS-BCAST_DVB_Adaptation-V1_0-20071219-D	
	19 Jan 2009	1, 3.2, 3.3, 4.1, 6.2.4	Incorporated the following agreed CRs: OMA-BCAST-v1_1-2008-0165- CR_BDS_renaming_DVBSH_Adaptation	
	27 Feb 2009		Incorporated the following agreed CRs: OMA-BCAST-v1_1-2009-0011- CR_DVBSH_Adaptation_Alignments_and_references OMA-BCAST-v1_1-2009-0013R01- CR_DVBSH_Adaptation_Overview OMA-BCAST-v1_1-2009-0014R01- CR_DVBSH_Adaptation_Service_Guide_discovery OMA-BCAST-v1_1-2009-0015- CR_DVBSH_Adaptation_cell_identification.zip OMA-BCAST-v1_1-2009-0019- CR_DVBSH_Adaptation_BCSTM0_BDSEntryPoint	
	07 May 2009	3.2, Appendix C	Incorporated the following agreed CRs: OMA-BCAST-v1_1-2009-0066R01- CR_DVBSH_adaptation_Regionalized_Service_Guide_scenarios	
	26 Jun 2009	3.3, 5.1, 5.2, 5.3, 5.4, 6.1, 6.3.4.1, 8, C.1, C.2	Incorporated the following agreed CRs: OMA-BCAST-v1_1-2009-0086R01- CR_DVBSH_Adaptation_DVB_service_ID_for_CellTargetArea OMA-BCAST-v1_1-2009-0089- CR_DVBSH_Adaptation_Walkthrough_rewording_and_cleanup OMA-BCAST-v1_1-2009-0122R01- CR_DVBSH_Adaptation_Correction_on_Overview_figure	
	28 Sep 2009	6.2.3, 6.3.4.1	Incorporated the following agreed CRs: OMA-BCAST-v1_1-2009-0181- CR_DVBSHAdaptation_Correction_on_BCAST_MO OMA-BCAST-v1_1-2009-0213- CR_BDSLocationID_Specified_In_DVBSH_Adaptation	
	22 Oct 2009	2, 5.4, 6, 6.3.5.1, 7, Appendix B	Incorporated the following agreed CRs: OMA-BCAST-v1_1-2009-0240- CR_DVB_references_in_DVBSH_Adaptation OMA-BCAST-v1_1-2009-0290R01- CR_Removal_of_BDS_specific_DVBSH_Adaptation	
	10 Nov 2009	3.2, 3.3	Incorporated the following (forgotten) agreed CR: OMA-BCAST-v1_1-2009-0132- CR_ISIM_DVB_SH	
	23 Nov 2009	All	Editorial clean-up by DSO	
	04 Feb 2010	6.3.5.2	Incorporated the following agreed CR: OMA-BCAST-v1_1-2009-0335- CR_Resolution_DVBSH_Adaptation_E001_AlcatelLucent	
	02 Apr 2010	6.3.4.3	Incorporated the following agreed CR: OMA-BCAST-v1_1-2010-0056R02- CR_DVBSH_Adaptation_I013_BDSSpecificEntryPointInfo	
	Candidate Version OMA-TS-BCAST_DVBSH_Adaptation-V1_1	14 Sep 2010	n/a	Approved by TP as candidate TP ref# OMA-TP-2010-0371- INP_BCAST_V1_1_ERP_and_ETR_for_Candidate_approval

Appendix B. Static Conformance Requirements (Normative)

The notation used in this appendix is specified in [IOPPROC].

B.1 SCR for BCAST Terminal

Item	Function	Reference	Status	Requirement
BCAST-DVBSHIPDC-C-001	Support BCAST Generic Adaptation on DVB-SH IPDC Network		O	BCAST-DVBSHIPDC-C-002 OR BCAST-DVBSHIPDC-C-004
BCAST-DVBSHIPDC-C-002	Support Broadcast Channel reception over IP Bearer	Section 6	O	BCAST-DVBSHIPDC-C-005 AND BCAST-DVBSHIPDC-C-008 AND BCAST-DVBSHIPDC-C-019 AND BCAST-DVBSHIPDC-C-020
BCAST-DVBSHIPDC-C-003	Support the adaptation of Service Protection Function for broadcast reception only		O	BCAST-DVBSHIPDC-C-015 AND BCAST-DVBSHIPDC-C-016 AND BCAST-DVBSHIPDC-C-017 AND BCAST-DVBSHIPDC-C-018
BCAST-DVBSHIPDC-C-004	Support Broadcast Channel and Interaction Channel for BCAST DVB-SH IPDC Adaptation	Section 6	O	BCAST-DVBSHIPDC-C-005 AND BCAST-DVBSHIPDC-C-006 AND BCAST-DVBSHIPDC-C-007 AND BCAST-DVBSHIPDC-C-008 AND BCAST-DVBSHIPDC-C-019 AND BCAST-DVBSHIPDC-C-020
BCAST-DVBSHIPDC-C-005	Support DVB-SH IPDC Media Codecs	Section 6.5.4	O	
BCAST-DVBSHIPDC-C-006	Support Service interaction between BSA and BSM and Terminal	Section 6.2.1	O	
BCAST-DVBSHIPDC-C-007	Support for the BCAST MO IPDC-SH sub nodes	Section 6.2.3	O	
BCAST-DVBSHIPDC-C-008	Support the adaptation of Service Guide Function for DVB-SH IPDC Network	Section 6.3	O	BCAST-DVBSHIPDC-C-009 AND BCAST-DVBSHIPDC-C-010 AND BCAST-DVBSHIPDC-C-011
BCAST-DVBSHIPDC-C-009	Support Service Guide Delivery over Broadcast Channel	Section 6.3.1	O	
BCAST-DVBSHIPDC-C-010	Support Session Description	Section 6.3.3	O	
BCAST-DVBSHIPDC-C-011	Support Service Guide Discovery by Terminal	Section 6.3.5	O	
BCAST-DVBSHIPDC-C-012	Support Adaptation of BCAST Service Protection Function for interactive and broadcast reception	Section 6.4	O	(BCAST-DVBSHIPDC-C-013 OR BCAST-DVBSHIPDC-C-014) AND BCAST-DVBSHIPDC-C-016 AND BCAST-DVBSHIPDC-C-017 AND BCAST-DVBSHIPDC-C-018
BCAST-DVBSHIPDC-C-013	Adaptation of DRM Profile DVB-SH IPDC	Section 6.4	O	BCAST-DVBSHIPDC-C-016
BCAST-DVBSHIPDC-C-014	Support Smartcard Profile	Section 6.4	O	
BCAST-DVBSHIPDC-	Support LTKM and	Section 6.4	O	

Item	Function	Reference	Status	Requirement
C-015	STKM restrictions for Service Protection			
BCAST-DVBSHIPDC-C-016	Support SRTP	Section 6.4	O	
BCAST-DVBSHIPDC-C-017	Support IPSEC	Section 6.4	O	
BCAST-DVBSHIPDC-C-018	Support ISMACryp	Section 6.4	O	
BCAST-DVBSHIPDC-C-019	Support File Distribution extensions	Section 6.5.1	O	
BCAST-DVBSHIPDC-C-020	Support Buffer Control	Section 6.5.3.1	O	

B.2 SCR for BCAST BSM

Item	Function	Reference	Status	Requirement
BCAST- DVBSHIPDC-BSM-001	Support BCAST Generic Adaptation on DVB-SH IPDC Network	Section 6	O	BCAST- DVBSHIPDC-BSM-002 AND BCAST- DVBSHIPDC-BSM - 003
BCAST- DVBSHIPDC-BSM-002	Support Broadcast and interactive communication between BSM and Terminal		O	
BCAST- DVBSHIPDC-BSM-003	Support for the BCAST MO IPDC-SH sub nodes	Section 6.2.3	O	

B.3 SCR for BCAST BSD/A

Item	Function	Reference	Status	Requirement
BCAST-DVBSHIPDC-BSDA-001	Support BCAST Generic Adaptation on DVB-SH IPDC Network	Section 6	O	(BCAST-DVBSHIPDC-BSDA-002 AND BCAST-DVBSHIPDC-BSDA-003 AND BCAST-DVBSHIPDC-BSDA-007) OR (BCAST-DVBSHIPDC-BSDA-003 AND BCAST-DVBSHIPDC-BSDA-007)
BCAST-DVBSHIPDC-BSDA-002	Support Interactive communication between BSDA and Terminal		O	
BCAST-DVBSHIPDC-BSDA-003	Support adaptation of Service Guide Function for DVB-SH IPDC Network	Section 6.3	O	BCAST-DVBSHIPDC-BSDA-004 AND BCAST-DVBSHIPDC-BSDA-005 AND BCAST-DVBSHIPDC-BSDA-006
BCAST-DVBSHIPDC-BSDA-004	Support Service Guide Delivery over Broadcast Channel extensions	Section 6.3.1	O	
BCAST-DVBSHIPDC-BSDA-005	Support Session Description	Section 6.3.3	O	

Item	Function	Reference	Status	Requirement
BCAST-DVBSHIPDC- BSDA-006	Support Service Guide Discovery by Terminal	Section 6.3.5	O	
BCAST-DVBSHIPDC- BSDA-007	Support Buffer Control	Section 6.5.3.1	O	

B.4 SCR for BCAST BSA

Item	Function	Reference	Status	Requirement
BCAST- DVBSHIPDC- BSA-001	Support BCAST Generic Adaptation on DVB-SH IPDC Network	Section 6	O	

Appendix C. Regionalized Service Guide Scenarios (Informative)

C.0 Overview

This appendix provides some scenarios which can safely be deployed with regard to consistency of regionalized Service Guide delivery on all cells of a DVB-SH network, even for BCAST terminals with no return channel.

These scenarios are mainly destined to the attention of SG-G/SG-D on network side. On terminal side, which scenario is being used is transparent to SG-C (the SG-C just needs to apply BroadcastArea handling in a generic way).

For the sake of simplification, the scenarios assume that there is one Service Guide (ProviderURI) spanning over all regions. In reality, several Service Guides may coexist, with some of them only available on satellite, some of them spanning over a few regions (but not all of them), etc.

In this appendix, a few terms are being used to shorten the wording:

- Common SGDU: SGDU transported in a SG Delivery Channel carried by the common DVB service.
- Local SGDU: SGDU transported in a SG Delivery Channel carried by a local DVB service.
- Common SG fragment: a SG fragment which takes part in the announcement of a BCAST service carried by the common DVB service. It is usually transported in a common SGDU, but can be transported in a local SGDU as well (see scenario C.4).
- Local SG fragment: a SG fragment which takes part in the announcement of a BCAST service carried by a local DVB service. It is usually transported in a local SGDU, and exceptionally in a common SGDU (see scenario C.6).

Note: when applied to BCAST service, SG Announcement Channel, SG Delivery Channel and SGDU, “local” denotes the transport; when applies to SG fragment, “local” denotes the type of BCAST service (common or local) announced.

The list of scenarios is not exhaustive, any kind of scenarios can be imagined provided basic consistency rules are observed:

1. Fragments in SGDUs delivered on common DVB service can only reference fragments in SGDUs delivered on common DVB service.
2. Fragments in SGDUs delivered on a local DVB service can only reference fragments in SGDUs delivered on this local DVB service, or on common DVB service, or on another local DVB service always transmitted along with this local DVB service (see S4 in C.1. scenario).
3. Fragments taking part of local BCAST services announcement have to be linked to a Service Guide BroadcastArea.

When a BroadcastArea is specified in the SG for a service or content item, the scenarios implicitly assume that a location_based_restriction Access Criteria descriptor can be present also in the STKMs involved in the protection of this service or content item.

C.1 Scenario of BroadcastArea instantiations and usages

This scenario describes various usages of SG BroadcastArea in the context of DVB-SH network.

The configuration taken as an example is depicted by Figure 5:

- One Partially Available Transport Stream, composed of one common DVB service (S0) carrying the common SG Announcement Channel, three local DVB services (S1, S2, S3) each carrying a local SG Announcement Channel, and one local DVB service (S4) carrying no local SG Announcement Channel, which role is to carry local IP flows shared between Region 2 and Region 3.

Note: instantiation of shared local DVB services like S4 might not be usual, but it is worth being mentioned though.

- Four regions: one satellite region (cell C0) and three terrestrial regions (encompassing respectively cells C10..C15, cells C20..C26 and cells C30..C37).

- In each region, one Regionalized TS is transmitted (TS 0 = S0, TS 1 = S0 + S1, TS 2 = S0 + S2 + S4, TS 3 = S0 + S3 + S4). The terminal, using the SDT which signals DVB service ID availability for each Cell ID, can find the list of cells where the same combination of DVB services (i.e. the same Regionalized TS) is transmitted, which composes one region by definition.

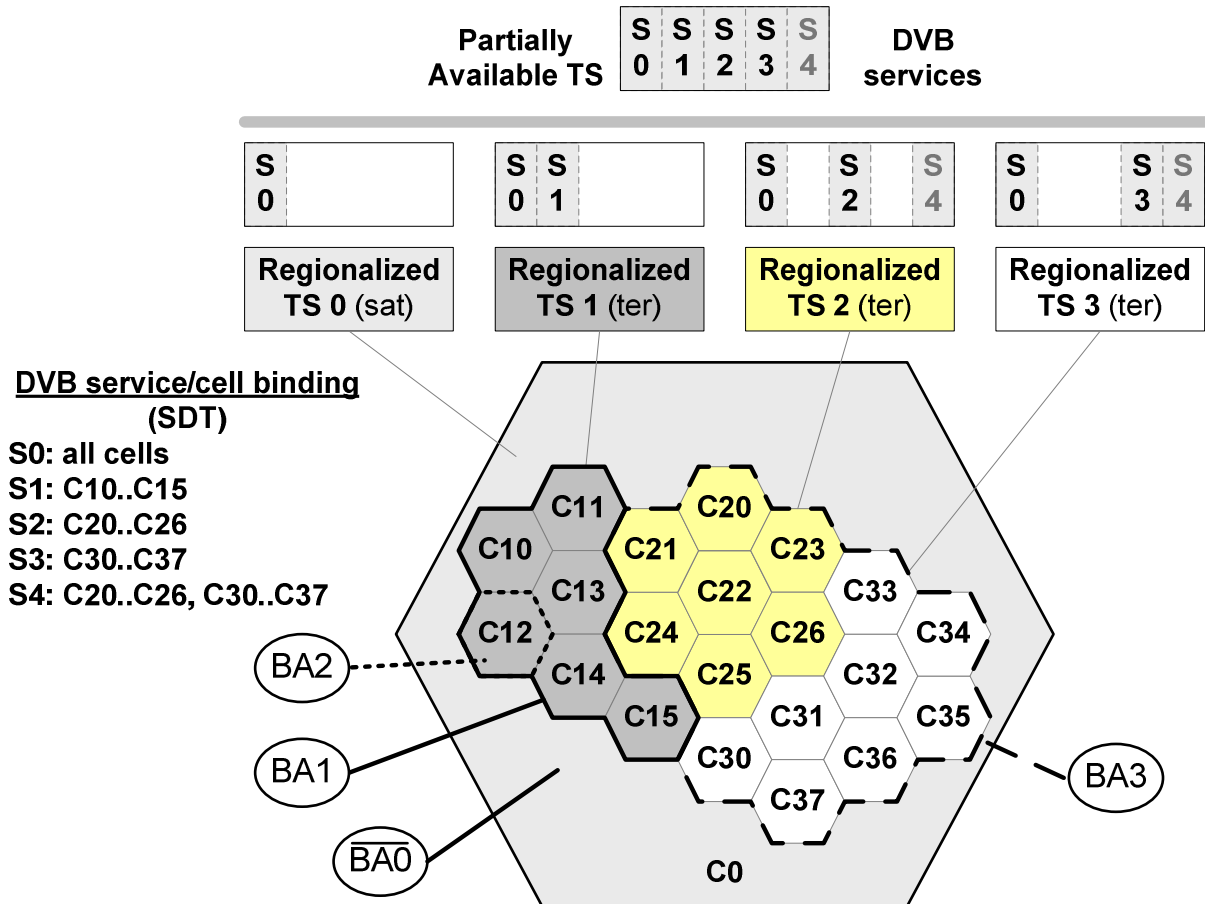

Figure 5: Scenarios of SG Broadcast Area instantiations and usages

This example illustrates various cases of Broadcast Area content:

- BroadcastArea 0 (BA0), which lists satellite cell C0 with “polarity” set to False, can be used to signal the availability of local BCAST services covering all terrestrial cells where the SG is delivered. These BCAST services are delivered on any transmitted local DVB service (either S1 and S2 and S3, or S1 and S4) – consequently they are instantiated multiple times in the source Partially Available Transport Stream.
 NOTE: this BroadcastArea 0 could alternatively be defined as just containing DVB service ID ‘S0’, with “polarity” set to False.
- BroadcastArea 1 (BA1), which lists terrestrial cells C10..C15 with “polarity” set to True, can be used to signal the availability of local BCAST services covering the whole Region 1. These BCAST services are those delivered on local DVB service S1.
 NOTE: this BroadcastArea 1 could alternatively be defined as just containing DVB service ID ‘S1’, with “polarity” set to True.
- BroadcastArea 2 (BA2), which lists terrestrial cell C12 with “polarity” set to True, can be used to signal the availability of local BCAST services covering a portion of Region 1 (e.g. a city district). These BCAST services are delivered on local DVB service S1.

NOTE: this BroadcastArea 2 could not be alternatively defined via a list of DVB service IDs.

- BroadcastArea 3 (BA3), which lists terrestrial cells C20..C26 and C30..C37 with “polarity” set to True, can be used to signal the availability of local BCAST services covering the whole Regions 2 and 3. These BCAST services are those delivered on “shared” local DVB service S4.

NOTE: this BroadcastArea 3 could alternatively be defined as just containing DVB service ID ‘S4’, with “polarity” set to True.

On a given terrestrial cell where local BCAST services are available, there must be delivered some Service/Content fragments (and associated fragments) containing a BroadcastArea encompassing the current cell at least - otherwise these local BCAST services could not be discovered by the terminal. But in addition, it is also possible to deliver Service/Content fragments (and associated fragments) containing a BroadcastArea *not* encompassing the current cell (but instead some cells of a neighboring region). The acquisition of such SG fragments “not valid on current cell but valid on another cell” allows the terminal to speed up service discovery when moving from one region to another.

C.2 Scenario of basic common and local SG delivery

This regionalized SG scenario describes the basic way of delivering common and local fragments of a regionalized SG.

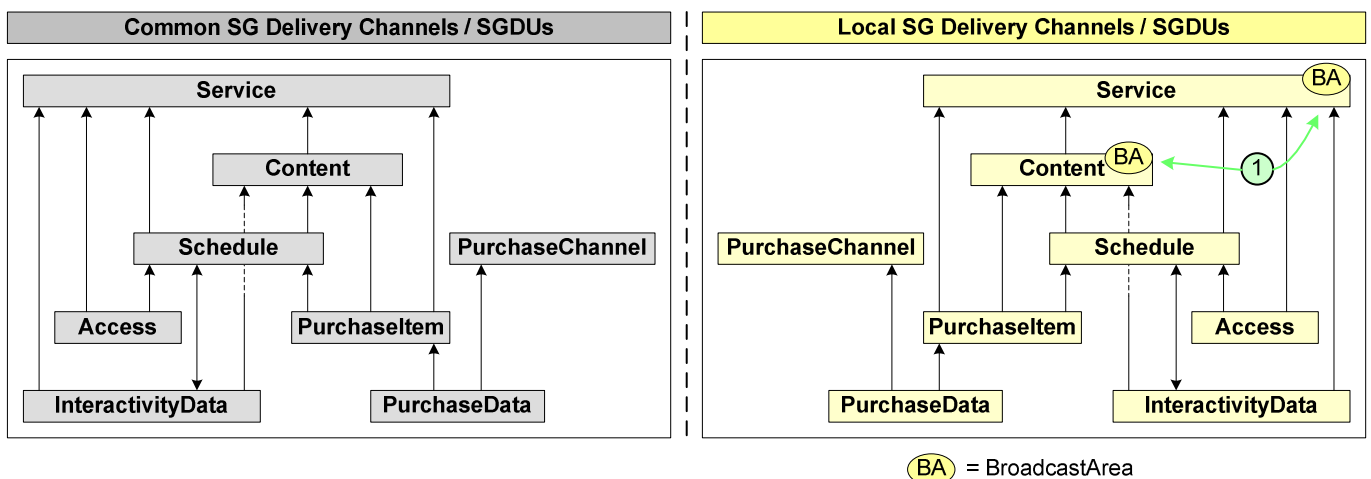

Figure 6: Scenario of basic common and local SG delivery

- In the common SG Delivery Channels (left part of Figure 6), the SGDUs carry fragments consistent all together, which role is to announce common BCAST services. In this subset, SG BroadcastArea in Service and Content fragments needs not be used, as these fragments announce common BCAST services available on all cells where the Service Guide is transmitted.
- In the local SG Delivery Channels (right part of the figure), the SGDUs carry fragments consistent all together, which role is to announce local BCAST services only. In this basic scenario C.2, these fragments have no relationship with the fragments delivered on common SG Delivery Channels. This implies for instance that the user cannot be proposed a single purchase item bundling at the same time common BCAST services and local BCAST services, and instead has to purchase two purchase items (one common, one local) separately.
- Fragments delivered on both types of SGDUs (common and local) are meant to be aggregated together as part of the same global Service Guide identified by the ProviderURI selected during SG bootstrap phase.
- Directly or indirectly, all fragments delivered in local SGDUs are linked to Service or Content fragment(s) containing a BroadcastArea ① listing cells of the DVB-SH network. On terminal side, this link can be established simply for some fragments like Schedule, but less easily for other fragments like PurchaseChannel (as the link goes through PurchaseData, and then to PurchaseItem, etc.). Still, it is crucial to establish this link, otherwise when

moving to another region, the terminal could mistakenly present to the user local services which are not available in this region.

C.3 Scenario of mixing common and local purchase information

This regionalized SG scenario describes how common and local purchase information can relate to each other while guaranteeing SG consistency.

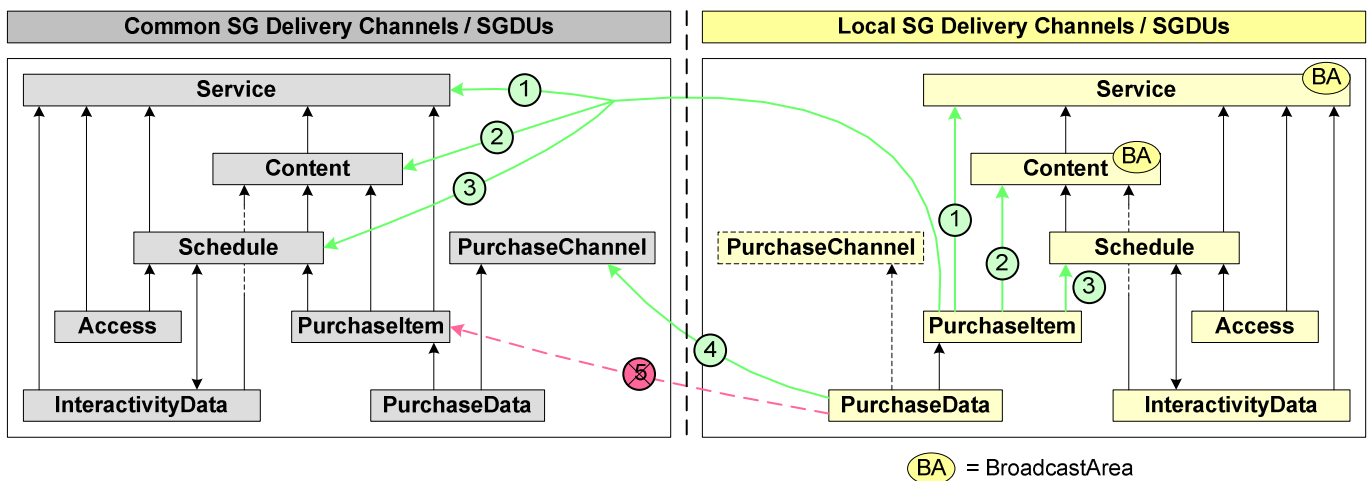

Figure 7: Scenario of mixing common and local purchase information

1. A PurchaseItem fragment delivered in local SGDUs can reference local Service fragments (or Content or Schedule), but also at the same time common Service fragments ① (or Content ② or Schedule ③) delivered in common SGDUs. This allows to bundle common and local services, while ensuring SG consistency.
2. A PurchaseData fragment delivered in local SGDUs can reference a common PurchaseChannel fragment ④ delivered in common SGDUs. This is appropriate when the same purchase channel is usable on all regions where the Service Guide is delivered, and moreover it decreases the number of PurchaseChannel fragments delivered in local SGDUs.
3. It is not possible for a local PurchaseData fragment ⑤ to directly reference a common PurchaseItem, because this PurchaseData is not linked to any BroadcastArea which could tell the terminal, following SG acquisition, on which cell this PurchaseData fragment can be used.

C.4 Scenario of complementing common SG fragments using local SG delivery channels

This regionalized SG scenario describes how the common SG fragments delivered on common DVB service can be complemented by common SG fragments delivered on local DVB service, using criteria grouping in SGDDs. For instance:

- a common SGDD could include a descriptorEntry containing TimeGroupingCriteria [NOW, NOW+2 Days] and referencing SGDUs in a common SG Delivery Channel.
- a local SGDD could include a copy of this descriptorEntry (i.e. containing TimeGroupingCriteria [NOW, NOW+2 Days] and referencing the same SGDUs in same common SG Delivery Channel). In addition it could include a

descriptorEntry containing TimeGroupingCriteria [NOW + 3 days, NOW+7 Days] and referencing SGDUs in a local SG Delivery Channel.

This way, time depth of common SG fragments can be increased under terrestrial reception, while not impacting on satellite bandwidth.

Figure 8 below illustrates the kinds of fragments that can be delivered this way:

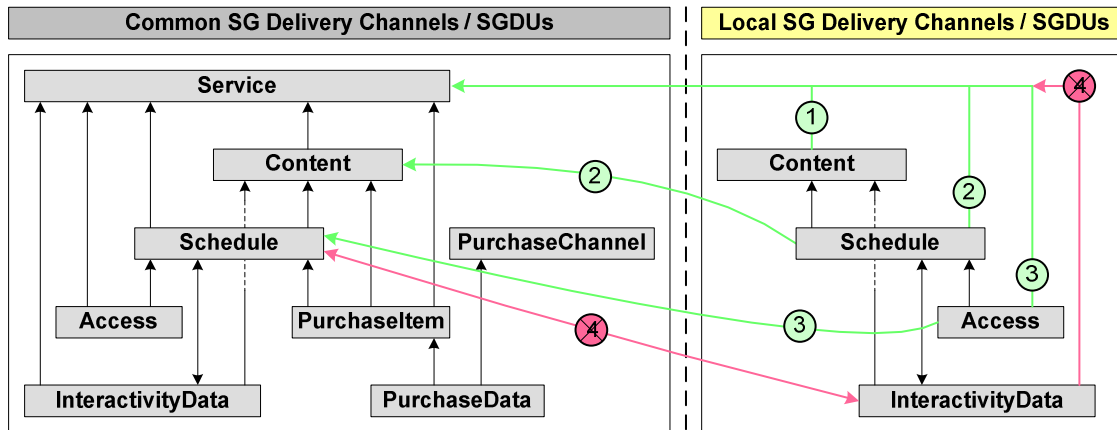

Figure 8: Scenario of complementing common SG fragments using local SG delivery channels

1. A common Content fragment ① can be delivered in a local SGDU if this fragment refers to a Service fragment delivered in common SGDUs, and if it is referred to by fragments delivered in local SGDUs. Such a Content fragment does not contain any BroadcastArea since it takes part of common BCAST services announcement.
2. The same possibility applies to Schedule fragments ② delivered in local SGDUs, and referencing these Content fragments, or Content fragments delivered in common SGDUs.
3. The same possibility (not very useful) applies to Access fragments ③ delivered in local SGDUs, and referencing these Schedule fragments, or Service or Schedule fragments delivered in common SGDUs.
4. It is not possible for an InteractivityData fragment ④ delivered in local SGDU to reference a Schedule fragment delivered in common SGDU, as it would break SG consistency (since the Schedule fragment needs in turn to reference this InteractivityData fragment, not transmitted on all cells where the Service Guide is delivered).

C.5 Scenario of overriding common content item by local content item

This regionalized SG scenario describes how common programs can be overridden by local programs (e.g. national news by regional news).

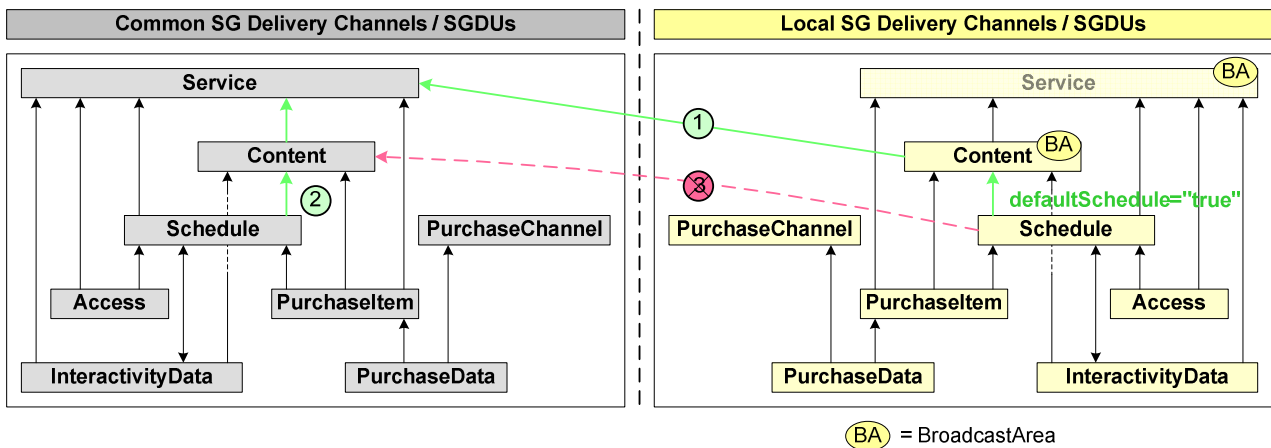

Figure 9: Scenario of overriding common content item by local content item

1. In the local SGDUs, a Content fragment ① contains a BroadcastArea and references a common Service fragment delivered in a common SGDU. In the local SGDUs also are delivered some Schedule fragments referencing this Content fragment, and with “defaultSchedule” set to True.
2. In the common SGDUs, the Schedule fragments ② linked also (via common Content fragments) to the same common Service fragment, do not contain “defaultSchedule” attribute. Thus the terminal, when on a cell encompassed by BroadcastArea of local Content fragment, will determine that two content items (one common, one local) are scheduled at the same time for this Service, and by applying defaultSchedule priority rule, will select the local content item. Note that both content items are delivered anyway (one on common DVB service, one on local DVB service) regardless of terminal selection.
3. A Schedule fragment ③ in local SGDU referencing a Content fragment in common SGDU... would lead to unpredictable terminal behavior. Since the Schedule fragment is not linked to any BroadcastArea, the terminal would interpret it as complementing common BCAST services announcement (see scenario C.4).

C.6 Scenario of mixed purchase item delivered on common SG delivery channel

This regionalized SG scenario describes how a purchase item delivered in a common SG Delivery Channel can reference not only common Service fragments but also local Service fragments, while not breaking SG consistency. This scenario extends somehow scenario C.3: purchase items can bundle common and local services, but as opposed to C.3 scenarios, these mixed purchase items can be purchased/subscribed to from any cell (including satellite cell).

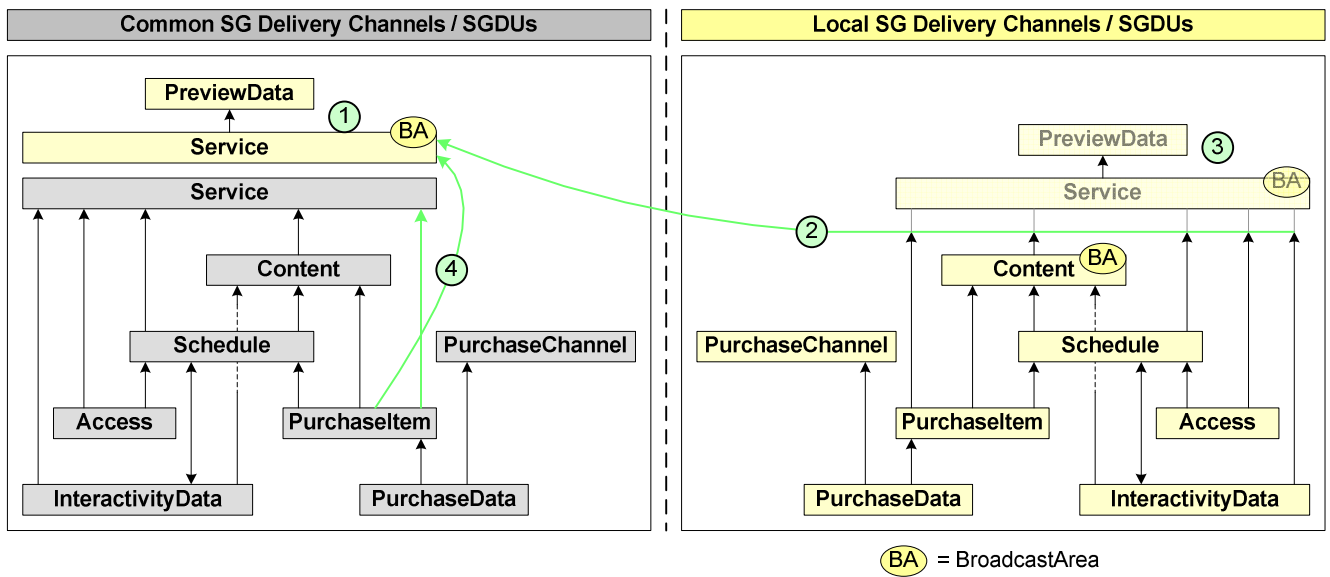

Figure 10: Scenario of mixed purchase item delivery on common SG delivery channel

1. A Service fragment ① describing a local BCAST service is delivered in common SG Delivery Channel instead of local SG Delivery Channel. To ensure SG consistency, any PreviewData fragment referenced by this local Service fragment needs also be delivered in common SG Delivery Channel. Local fragments ② delivered in local SG Delivery Channel can safely reference this local Service fragment.
2. These local Service fragments and related preview data need not be instantiated also in local SG Delivery Channel, as common SG Delivery Channel is transmitted on all cells. If this is wanted however ③ (for instance to ease grouping criteria partitioning), these local SG fragments need to be an exact copy of their siblings ① delivered in common SG Delivery Channel.
3. Finally, PurchaseItem fragments ④ in common SG Delivery Channel can bundle at the same time common Service fragments and local Service fragments delivered in a common SG Delivery Channel.

Depending on number and size of local Service and PreviewData fragments, this scenario can quite easily consume a lot of satellite bandwidth, so it should be discouraged wherever satellite bandwidth cost is critical. It is a good example though of a compromise between network constraints and SG instantiation flexibility.