



Mobile Location Protocol 3.3

Candidate Version 3.3 – 01 Oct 2009

Open Mobile Alliance
OMA-TS-MLP-V3_3-20091001-C

Use of this document is subject to all of the terms and conditions of the Use Agreement located at <http://www.openmobilealliance.org/UseAgreement.html>.

Unless this document is clearly designated as an approved specification, this document is a work in process, is not an approved Open Mobile Alliance™ specification, and is subject to revision or removal without notice.

You may use this document or any part of the document for internal or educational purposes only, provided you do not modify, edit or take out of context the information in this document in any manner. Information contained in this document may be used, at your sole risk, for any purposes. You may not use this document in any other manner without the prior written permission of the Open Mobile Alliance. The Open Mobile Alliance authorizes you to copy this document, provided that you retain all copyright and other proprietary notices contained in the original materials on any copies of the materials and that you comply strictly with these terms. This copyright permission does not constitute an endorsement of the products or services. The Open Mobile Alliance assumes no responsibility for errors or omissions in this document.

Each Open Mobile Alliance member has agreed to use reasonable endeavors to inform the Open Mobile Alliance in a timely manner of Essential IPR as it becomes aware that the Essential IPR is related to the prepared or published specification. However, the members do not have an obligation to conduct IPR searches. The declared Essential IPR is publicly available to members and non-members of the Open Mobile Alliance and may be found on the “OMA IPR Declarations” list at <http://www.openmobilealliance.org/ipr.html>. The Open Mobile Alliance has not conducted an independent IPR review of this document and the information contained herein, and makes no representations or warranties regarding third party IPR, including without limitation patents, copyrights or trade secret rights. This document may contain inventions for which you must obtain licenses from third parties before making, using or selling the inventions. Defined terms above are set forth in the schedule to the Open Mobile Alliance Application Form.

NO REPRESENTATIONS OR WARRANTIES (WHETHER EXPRESS OR IMPLIED) ARE MADE BY THE OPEN MOBILE ALLIANCE OR ANY OPEN MOBILE ALLIANCE MEMBER OR ITS AFFILIATES REGARDING ANY OF THE IPR'S REPRESENTED ON THE “OMA IPR DECLARATIONS” LIST, INCLUDING, BUT NOT LIMITED TO THE ACCURACY, COMPLETENESS, VALIDITY OR RELEVANCE OF THE INFORMATION OR WHETHER OR NOT SUCH RIGHTS ARE ESSENTIAL OR NON-ESSENTIAL.

THE OPEN MOBILE ALLIANCE IS NOT LIABLE FOR AND HEREBY DISCLAIMS ANY DIRECT, INDIRECT, PUNITIVE, SPECIAL, INCIDENTAL, CONSEQUENTIAL, OR EXEMPLARY DAMAGES ARISING OUT OF OR IN CONNECTION WITH THE USE OF DOCUMENTS AND THE INFORMATION CONTAINED IN THE DOCUMENTS.

© 2009 Open Mobile Alliance Ltd. All Rights Reserved.

Used with the permission of the Open Mobile Alliance Ltd. under the terms set forth above.

Contents

1.	SCOPE	9
2.	REFERENCES	10
2.1	NORMATIVE REFERENCES	10
2.2	INFORMATIVE REFERENCES	10
3.	TERMINOLOGY AND CONVENTIONS	12
3.1	CONVENTIONS	12
3.2	DEFINITIONS	12
3.3	ABBREVIATIONS	13
4.	INTRODUCTION	14
5.	MOBILE LOCATION PROTOCOL	15
5.1	OVERVIEW	15
5.1.1	MLP structure	15
5.1.2	MLP extension mechanism	17
5.2	MOBILE LOCATION SERVICE DEFINITIONS	18
5.2.1	Transport Protocol Layer Definitions	18
5.2.2	Element Layer Definitions	19
5.2.2.1	<i>Identity Element Definitions</i>	19
5.2.2.2	<i>Function Element Definitions</i>	20
5.2.2.3	<i>Location Element Definitions</i>	21
5.2.2.4	<i>Result Element Definitions</i>	23
5.2.2.5	<i>Shape Element Definitions</i>	24
5.2.2.6	<i>Quality of Position Element Definitions</i>	26
5.2.2.7	<i>GSM Network Parameters Element Definitions</i>	27
5.2.2.8	<i>Context Element Definitions</i>	28
5.2.3	Service Layer Definitions	28
5.2.3.1	<i>Header Components</i>	28
5.2.3.1.1	Header DTD	29
5.2.3.2	<i>Standard Location Immediate Service</i>	30
5.2.3.2.1	Standard Location Immediate Request DTD	31
5.2.3.2.2	Standard Location Immediate Answer DTD	32
5.2.3.2.3	Standard Location Immediate Report DTD	34
5.2.3.3	<i>Emergency Location Immediate Service</i>	34
5.2.3.3.1	Emergency Location Immediate Request DTD	35
5.2.3.3.2	Emergency Location Immediate Answer DTD	37
5.2.3.3.3	Emergency Location Immediate Report DTD	37
5.2.3.4	<i>Standard Location Reporting Service</i>	38
5.2.3.4.1	Standard Location Report DTD	39
5.2.3.4.2	Standard Location Report Answer DTD	40
5.2.3.5	<i>Emergency Location Reporting Service</i>	41
5.2.3.5.1	Emergency Location Report DTD	41
5.2.3.6	<i>Triggered Location Reporting Service</i>	42
5.2.3.6.1	Triggered Location Reporting Request DTD	44
5.2.3.6.2	Triggered Location Reporting Answer DTD	48
5.2.3.6.3	Triggered Location Report DTD	49
5.2.3.6.4	Triggered Location Reporting Stop Request DTD	50
5.2.3.6.5	Triggered Location Reporting Stop Answer DTD	51
5.2.3.7	<i>General Error Message Definition</i>	51
5.2.3.8	<i>Historic Location Immediate Service</i>	52
5.2.3.8.1	Historic Location Immediate Request DTD	53
5.2.3.8.2	Historic Location Immediate Answer DTD	54
5.2.3.8.3	Historic Location Immediate Report DTD	55
5.3	ELEMENTS AND ATTRIBUTES IN DTD	56
5.3.1	add_info	56
5.3.2	alt	56
5.3.3	alt_acc	56

5.3.3.1	<i>qos_class</i>	57
5.3.4	alt_unc.....	57
5.3.5	angle.....	57
5.3.6	angularUnit.....	58
5.3.7	Base64Map.....	58
5.3.8	batch_cond.....	58
5.3.8.1	<i>batch_type</i>	58
5.3.9	Box.....	59
5.3.9.1	<i>gid</i>	59
5.3.9.2	<i>srsName</i>	59
5.3.10	cc.....	60
5.3.11	cellid.....	60
5.3.12	change_area.....	60
5.3.12.1	<i>type</i>	61
5.3.12.2	<i>loc_estimates</i>	61
5.3.13	CircularArcArea.....	61
5.3.13.1	<i>gid</i>	62
5.3.13.2	<i>srsName</i>	62
5.3.14	CircularArea.....	62
5.3.14.1	<i>gid</i>	62
5.3.14.2	<i>srsName</i>	62
5.3.15	civicloc_element.....	62
5.3.15.1	<i>element_type</i>	63
5.3.16	code.....	63
5.3.17	codeSpace.....	63
5.3.18	codeword.....	63
5.3.19	direction.....	64
5.3.20	distanceUnit.....	64
5.3.21	duration.....	64
5.3.22	edition.....	65
5.3.23	EllipticalArea.....	65
5.3.23.1	<i>gid</i>	65
5.3.23.2	<i>srsName</i>	66
5.3.24	eme_event.....	66
5.3.24.1	<i>eme_trigger</i>	66
5.3.25	eme_pos.....	66
5.3.25.1	<i>pos_method</i>	67
5.3.26	esrd.....	67
5.3.26.1	<i>type</i>	67
5.3.27	esrk.....	68
5.3.27.1	<i>type</i>	68
5.3.28	Height.....	68
5.3.29	Hemisphere.....	69
5.3.30	hor_acc.....	69
5.3.30.1	<i>qos_class</i>	69
5.3.31	id.....	69
5.3.32	imsi.....	70
5.3.33	inRadius.....	70
5.3.34	interval.....	70
5.3.35	ip_address.....	71
5.3.36	lac.....	71
5.3.37	lcs_ref.....	71
5.3.38	lev_conf.....	71
5.3.39	LinearRing.....	72
5.3.39.1	<i>gid</i>	72
5.3.39.2	<i>srsName</i>	72
5.3.40	LineString.....	72
5.3.40.1	<i>gid</i>	73

5.3.40.2	<i>srsName</i>	73
5.3.41	<i>ll_acc</i>	73
5.3.41.1	<i>qos_class</i>	73
5.3.42	<i>lmsi</i>	74
5.3.43	<i>loc_type</i>	74
5.3.43.1	<i>type</i>	74
5.3.43.2	<i>per_type</i>	75
5.3.44	<i>MapRequest</i>	75
5.3.44.1	<i>MapdataType</i>	76
5.3.44.2	<i>MimeType</i>	76
5.3.45	<i>max_loc_age</i>	76
5.3.46	<i>mcc</i>	77
5.3.47	<i>mnc</i>	77
5.3.48	<i>ms_action</i>	77
5.3.48.1	<i>type</i>	77
5.3.49	<i>msid</i>	78
5.3.49.1	<i>type</i>	78
5.3.49.2	<i>enc</i>	79
5.3.50	<i>MultiLineString</i>	79
5.3.50.1	<i>gid</i>	79
5.3.50.2	<i>srsName</i>	79
5.3.51	<i>MultiPoint</i>	79
5.3.51.1	<i>gid</i>	80
5.3.51.2	<i>srsName</i>	80
5.3.52	<i>MultiPolygon</i>	80
5.3.52.1	<i>gid</i>	80
5.3.52.2	<i>srsName</i>	80
5.3.53	<i>name_area</i>	80
5.3.54	<i>ndc</i>	81
5.3.55	<i>nmr</i>	81
5.3.56	<i>no_of_reports</i>	81
5.3.57	<i>outRadius</i>	82
5.3.58	<i>plmn</i>	82
5.3.59	<i>Point</i>	82
5.3.59.1	<i>gid</i>	82
5.3.59.2	<i>srsName</i>	83
5.3.60	<i>Polygon</i>	83
5.3.60.1	<i>gid</i>	83
5.3.60.2	<i>srsName</i>	83
5.3.61	<i>pos</i>	83
5.3.61.1	<i>pos_method</i>	84
5.3.61.2	<i>result_type</i>	84
5.3.62	<i>prio</i>	84
5.3.62.1	<i>type</i>	84
5.3.63	<i>pwd</i>	84
5.3.64	<i>qos_not_met</i>	85
5.3.65	<i>radius</i>	85
5.3.66	<i>req_id</i>	86
5.3.67	<i>requested_positiondata</i>	86
5.3.68	<i>requestmode</i>	86
5.3.69	<i>requestor</i>	87
5.3.69.1	<i>type</i>	87
5.3.70	<i>resp_req</i>	87
5.3.70.1	<i>type</i>	88
5.3.71	<i>resp_timer</i>	88
5.3.72	<i>result</i>	88
5.3.72.1	<i>resid</i>	89
5.3.73	<i>semiMajor</i>	89
5.3.74	<i>semiMinor</i>	89

5.3.75	Service attributes.....	90
5.3.75.1	res_type.....	90
5.3.75.2	ver.....	90
5.3.76	serviceid.....	90
5.3.76.1	type.....	91
5.3.77	session.....	91
5.3.77.1	type.....	91
5.3.78	sessionid.....	92
5.3.79	speed.....	92
5.3.80	start_time.....	92
5.3.80.1	utc_off.....	93
5.3.81	startAngle.....	93
5.3.82	stop_time.....	93
5.3.83	stopAngle.....	94
5.3.83.1	utc_off.....	94
5.3.84	strict.....	94
5.3.85	subclient.....	94
5.3.85.1	last_client.....	95
5.3.86	ta.....	95
5.3.87	target_area.....	95
5.3.88	time.....	95
5.3.88.1	utc_off.....	96
5.3.89	time_remaining.....	96
5.3.90	trans_id.....	96
5.3.91	trl_pos.....	97
5.3.91.1	trl_trigger.....	97
5.3.91.2	pos_method.....	97
5.3.92	url.....	98
5.3.93	vlrno.....	98
5.3.94	vmcno.....	98
5.3.95	Width.....	98
5.3.96	X.....	99
5.3.97	Y.....	99
5.3.98	Z.....	100
5.3.99	Zone.....	100
5.3.100	Zoom.....	100
5.3.100.1	ZoomType.....	100
5.4	RESULT CODES.....	101
5.4.1	Result codes.....	101
5.5	ADAPTATION TO 3GPP LCS (INFORMATIVE).....	103
5.5.1	Version mapping between 3GPP TS23.271 and this specification.....	103
5.5.2	The terminology mapping table with 3GPP LCS Specifications.....	103
5.5.3	The corresponding terms used for the location procedures in 3GPP LCS Definition.....	104
5.5.4	Error Mapping (Informative).....	105
5.6	HTTP MAPPING.....	105
5.6.1	Location Services using HTTP.....	106
5.6.2	Request and Response Encapsulation.....	106
5.6.2.1	Service Initiation DTD.....	106
5.6.2.2	Service Result DTD.....	107
5.6.2.3	Message Sequence Diagram.....	108
5.7	GEOGRAPHIC INFORMATION.....	109
5.7.1	Coordinate Reference systems (Informative).....	109
5.7.1.1	The Geoid, ellipsoids and datums.....	110
5.7.1.2	Coordinate systems.....	110
5.7.1.2.1	Cartesian coordinate systems.....	110
5.7.1.2.2	Ellipsoid coordinates.....	110
5.7.1.3	Coordinate Reference Systems.....	111
5.7.2	Coordinate Reference System Transformations (Informative).....	111

5.7.3	Methodology for defining CRSs and transformations in this protocol (Informative)	111
5.7.4	Supported coordinate systems and datum (Normative)	112
5.7.5	Shapes representing a geographical position (Informative)	112
5.7.5.1	<i>Ellipsoid point</i>	112
5.7.5.2	<i>Ellipsoid point with uncertainty circle</i>	112
5.7.5.3	<i>Ellipsoid point with uncertainty ellipse</i>	113
5.7.5.4	<i>Ellipsoid point with uncertainty arc</i>	113
5.7.5.5	<i>Polygon</i>	114
5.7.5.6	<i>LineString</i>	115
5.7.5.7	<i>Box</i>	115
5.7.5.8	<i>Geometries Collections</i>	115
APPENDIX A.	CHANGE HISTORY (INFORMATIVE)	116
A.1	APPROVED VERSION HISTORY	116
A.2	DRAFT/CANDIDATE VERSION V3_3 HISTORY	116
APPENDIX B.	STATIC CONFORMANCE REQUIREMENTS (NORMATIVE)	117
B.1	SCR FOR CLIENT	117
B.1.1	Service Initiation DTD	117
B.1.2	Service Result DTD	117
B.1.3	Header	118
B.1.4	Standard Location Immediate Request	118
B.1.5	Standard Location Immediate Answer	118
B.1.6	Standard Location Immediate Report	118
B.1.7	Emergency Location Immediate Request	119
B.1.8	Emergency Location Immediate Answer	119
B.1.9	Emergency Location Immediate Report	119
B.1.10	Standard Location Report	119
B.1.11	Standard Location Report Answer	119
B.1.12	Emergency Location Report	120
B.1.13	Triggered Location Reporting Request	120
B.1.14	Triggered Location Reporting Answer	120
B.1.15	Triggered Location Report	120
B.1.16	Triggered Location Reporting Stop Request	121
B.1.17	Triggered Location Reporting Stop Answer	121
B.1.18	Historic Location Immediate Request	121
B.1.19	Historic Location Immediate Answer	121
B.1.20	Historic Location Immediate Report	121
B.1.21	Support for Identity Elements	122
B.1.22	Support for Function Elements	122
B.1.23	Support for Location Elements	122
B.1.24	Support for Result Elements	123
B.1.25	Support for Shape Elements	123
B.1.26	Support for Quality of Position Elements	124
B.1.27	Support for GSM Network Parameters Elements	124
B.1.28	Support for Context Elements	124
B.1.29	Service attributes	125
B.1.30	Transport mechanisms	125
B.1.31	Services	125
B.2	SCR FOR SERVER	125
B.2.1	Service Initiation DTD	125
B.2.2	Service Result DTD	126
B.2.3	Header	126
B.2.4	Standard Location Immediate Request	127
B.2.5	Standard Location Immediate Answer	127
B.2.6	Standard Location Immediate Report	127
B.2.7	Emergency Location Immediate Request	127
B.2.8	Emergency Location Immediate Answer	128

B.2.9	Emergency Location Immediate Report	128
B.2.10	Standard Location Report	128
B.2.11	Standard Location Report Answer	128
B.2.12	Emergency Location Report	128
B.2.13	Triggered Location Reporting Request	129
B.2.14	Triggered Location Reporting Answer	129
B.2.15	Triggered Location Report	129
B.2.16	Triggered Location Reporting Stop Request	129
B.2.17	Triggered Location Reporting Stop Answer	130
B.2.18	Historic Location Immediate Request	130
B.2.19	Historic Location Immediate Answer	130
B.2.20	Historic Location Immediate Report	130
B.2.21	Support for Identity Elements	130
B.2.22	Support for Function Elements	131
B.2.23	Support for Location Elements	131
B.2.24	Support for Result Elements	132
B.2.25	Support for Shape Elements	132
B.2.26	Support for Quality of Position Elements	133
B.2.27	Support for Network Parameters Elements	133
B.2.28	Support for Context Elements	133
B.2.29	Service attributes	134
B.2.30	Transport mechanisms	134
B.2.31	Services	134

Figures

Figure 1: MLP in the context of the LCS Architecture	15
Figure 2: MLP Structure	15
Figure 3: Message Flow for the Standard Location Immediate Service	31
Figure 4: Message Flow for the Emergency Location Immediate Service	35
Figure 5: Message flow for the Standard Location Reporting Service	39
Figure 6: Message Flow for the Emergency Location Reporting Service	41
Figure 7: Message Flow for the Triggered Location Reporting Service	43
Figure 8: Message Flow for the Historic Location Immediate Service	53
Figure 9: HTTP sequence for MLP request/response pairs	108
Figure 10: HTTP sequence for MLP reports	109
Figure 11: HTTP sequence for MLP Standard Location Reporting Service.	109
Figure 12: HTTP sequence for the General Error Message	109
Figure 13: Ellipsoid Coordinates	111
Figure 14: Ellipsoid point with uncertainty circle	113
Figure 15: Ellipsoid point with uncertainty ellipse	113
Figure 16: Ellipsoid point with uncertainty arc	114

1. Scope

The Mobile Location Protocol (MLP) is an application-level protocol for getting the position of mobile stations (mobile phones, wireless personal digital assistants, etc.) independent of underlying network technology, i.e. independent of location derivation technology and bearer as described in [MLS AD]. The MLP serves as the interface between a Location Server and a MLS Client. This specification defines the core set of operations that a Location Server should be able to perform.

2. References

2.1 Normative References

- [MLS AD] "OMA Mobile Location Service Architecture".
Open Mobile Alliance™. OMA-AD-MLS-V1_2, URL:
<http://www.openmobilealliance.org/>
- [IOPPROC] OMA Interoperability Policy and Process", Version 1.8, Open Mobile Alliance™. OMA-ORG-IOP-Process-V1_8, URL: <http://www.openmobilealliance.org/>
- [22.071] 3GPP TS 22.071 Release 7: "Location Services (LCS); Service description, Stage 1". URL:
http://www.3gpp.org/ftp/Specs/latest/Rel-7/22_series/
- [23.271] 3GPP TS 23.271 Release 7: "Functional stage 2 description of LCS" URL:
http://www.3gpp.org/ftp/Specs/latest/Rel-7/23_series/
- [RFC2119] "Key words for use in RFCs to Indicate Requirement Levels", IETF, S. Bradner. March 1997. URL: <http://www.ietf.org/rfc/rfc2119.txt>
- [RFC2616] "Hypertext Transfer Protocol –HTTP/1.1", IETF, R. Fielding, et al, June 1999. URL: <http://www.ietf.org/rfc/rfc2616.txt>
- [RFC2246] "The TLS Protocol Version 1.0", IETF, T. Dierks, et al, January 1999. URL: <http://www.ietf.org/rfc/rfc2246.txt>
- [RFC 4119] "A Presence-based GEOPRIV Location Object Format", IETF, J. Peterson, December 2005. URL: <http://www.ietf.org/rfc/rfc4119.txt>
- [RFC 5139] "Revised Civic Location Format for Presence Information Data Format Location Object", IETF, M. Thomson et al, February 2008
URL: <http://www.ietf.org/rfc/rfc5139.txt>
- [XML-1.0] "Extensible Markup Language (XML) 1.0" W3C Recommendation:
URL: <http://www.w3.org/TR/2000/REC-xml-20001006>
- [IANA] Internet Assigned Numbers Authority (IANA)
URL: <http://www.iana.org/>
- [ASCII] US-ASCII. Coded Character Set - 7-Bit American Standard Code for Information Interchange. Standard ANSI X3.4-1986, ANSI, 1986.

2.2 Informative References

- [23.032] 3GPP TS 23.032: " Universal Geographical Area Description (GAD)"
URL:http://www.3gpp.org/ftp/Specs/latest/Rel-6/23_series/
- [04.18] GSM 04.18: " Technical Specification Group GSM/EDGE Radio Access Network; Mobile radio interface layer 3 specification, Radio Resource Control Protocol"
URL:http://www.3gpp.org/ftp/Specs/latest/R1999/04_series/
- [29.002] 3GPP TS 29.002: "Digital cellular telecommunications system (Phase 2+); Mobile Application Part (MAP) specification". URL:http://www.3gpp.org/ftp/Specs/latest/Rel-7/29_series/
- [23.003] 3GPP TS 23.003: "Numbering, Addressing and Identification"
URL:http://www.3gpp.org/ftp/Specs/latest/Rel-7/23_series/
- [E164] ITU-T E.164: "The international public telecommunication numbering plan
- [J-STD-036] TR-45 J-STD-036 "Enhanced Wireless 9-1-1 Phase 2 Document"

- [IS-41D] IS-41D: " Cellular Radiotelecommunications Intersystem Operations", June 1997
- [AST] OpenGIS© Consortium Abstract Specification Topic 2: 01-063R2
URL: <http://www.opengis.org/techno/abstract/02-102.pdf>
- [CRS] OpenGIS© Consortium Recommendation Paper 01-014r5: Recommended Definition Data for Coordinate Reference Systems and Coordinate Transformations
URL: <http://www.opengis.org/techno/discussions/01-014r5.pdf>
- [GML] OpenGIS© Consortium Implementation Specification: Geography Markup Language V 2.0
URL: <http://www.opengis.net/gml/01-029/GML2.html>
- [GEO] OpenGIS© Consortium Abstract Specification Topic 1 Feature Geometry : 010101
URL: <http://www.opengis.org/techno/abstract/01-101.pdf>
- [RFC796] RFC 796: "Address mapping", IETF, J. Postel, September 1981, URL:
<http://www.ietf.org/rfc/rfc796.txt>
- [RFC3513] RFC 3513: "Internet Protocol Version 6 (IPv6) Addressing Architecture", IETF, R. Hinden and S. Deering, April 2003, URL: <http://www.ietf.org/rfc/rfc3513.txt>
- [05.10] 3GPP TS 05.10, "Radio subsystem synchronization",
URL:http://www.3gpp.org/ftp/Specs/latest/R1999/05_series/
- [UTC] ITU CCIR Recommendation "ITU-R-TF.460-4"

3. Terminology and Conventions

3.1 Conventions

The key words “MUST”, “MUST NOT”, “REQUIRED”, “SHALL”, “SHALL NOT”, “SHOULD”, “SHOULD NOT”, “RECOMMENDED”, “MAY”, and “OPTIONAL” in this document are to be interpreted as described in [RFC2119].

All sections and appendixes, except “Scope” and “Introduction”, are normative, unless they are explicitly indicated to be informative.

Notational Conventions and Generic Grammar

The following rules are used throughout this specification to describe basic parsing constructs.

- ANSI X3.4-1986 defines the US-ASCII coded character set, see [ASCII]

CR	= <US-ASCII CR, carriage return (13)>
LF	= <US-ASCII LF, linefeed (10)>
SP	= <US-ASCII SP, space (32)>

- A set of characters enclosed in brackets ([...]) is a one-character expression that matches any of the characters in that set, e.g., “[lcs]” matches either an “l”, “c”, or “s”. A range of characters is indicated with a dash, e.g., “[a-z]” matches any lower-case letter.
- The one-character expression can be followed by an interval operator, for example [a-zA-Z]{min,max} in which case the one-character expression is repeated at least min and at most max times, e.g., “[a-zA-Z]{2,4}” matches for example the strings “at”, “Good”, and “biG”.

DTD Syntax Notation

The table below describes the special characters and separators used in the DTDs defining the different services.

Character	Meaning
+	One or more occurrence
*	Zero or more occurrences
?	Optional
(...)	A group of expressions to be matched together
	OR...as in, “this or that”
,	Strictly ordered. Like an AND

3.2 Definitions

Le	Reference point between MLS Client and Location Server. See also [23.271]
Location Server	Software and/or hardware entity offering location capabilities.
Target	The entity being located.
Timing Advance	Parameter in GSM network used by the MS to advance its timings of transmissions to the Base Station so as to compensate for propagation delay. This parameter can also be used to estimate the distance between the MS and the Base Station.

3.3 Abbreviations

A-GPS	Assisted GPS
AFLT	Advanced Forward Link Triangulation positioning method
ANSI	American National Standards Institute
APN	Access Point Name
ASID	Anonymous Subscriber Identity
ASP	Application Service Provider
CRS	Coordinate Reference System
DMSH	Degrees Minutes Seconds Hemisphere
DTD	Document Type Definition
E-OTD	Enhanced Observed Time Difference (E-OTD)
EFLT	Enhanced Forward Link Triangulation positioning method
ESRK	Emergency Services Routing Key
GANSS	Galileo and Additional Global Navigation Satellite Systems
GEM	General Error Message
GML	Geography Markup Language
GMLC	Gateway Mobile Location Center
GMT	Greenwich Mean Time
GNSS	Global Navigation Satellite Systems
GPS	Global Positioning System
HLR	Home Location Register
HTTP	Hypertext Transfer Protocol
HTTPS	HTTP Secure
IMSI	International Mobile Station Identifier
LCS	Location Services
MLC	Mobile Location Center
MLP	Mobile Location Protocol
MPC	Mobile Positioning Center
MS	Mobile Station
MSID	Mobile Station Identifier
MSISDN	Mobile Station ISDN
NAI	Network Access Identifier
OTDOA	Observed Time Difference of Arrival
SOAP	Simple Object Access Protocol
SSL	Secure Socket Layer
TLS	Transport Layer Security
U-TDOA	Uplink Time Difference of Arrival
URI	Uniform Resource Identifier
URL	Uniform Resource Locator
UTM	Universal Transverse Mercator
WAP	Wireless Application Protocol
WGS	World Geodetic System
WSP	Wireless Session Protocol
XML	Extensible Markup Language

4. Introduction

The Mobile Location Protocol (MLP) is an application-level protocol for getting the position of mobile stations (mobile phones, wireless personal digital assistants, etc.) independent of underlying network technology, i.e. independent of location derivation technology and bearer. The MLP serves as the interface between a Location Server and a MLS (Mobile Location Service) Client. This specification defines the core set of operations that a Location Server should be able to perform. The purpose of this specification is to specify the detailed technical specification of the interface between a Location Server and a MLS Client described in [MLS AD]. In the 3GPP context, this specification will be an instantiation of the detailed technical specifications for the Le reference point as defined in [23.271].

5. Mobile Location Protocol

5.1 Overview

The Mobile Location Protocol (MLP) is an application-level protocol for querying the position of mobile stations independent of underlying network technology. The MLP serves as the interface between a Location Server and a location-based application (cf. Figure 1).

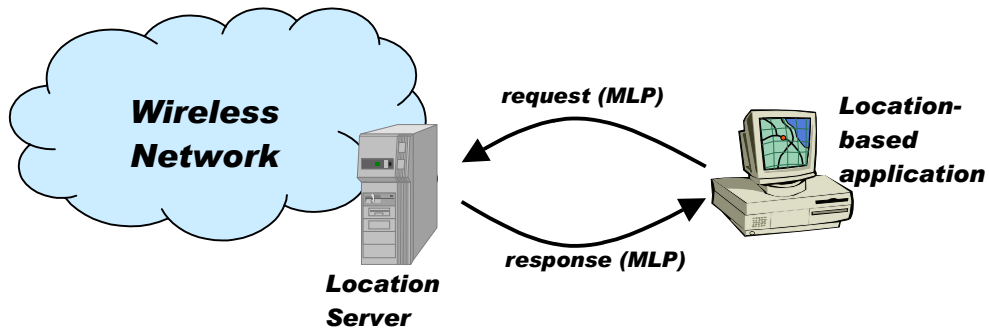

Figure 1: MLP in the context of the LCS Architecture

Possible realisations of a Location Server are the GMLC, which is the location server defined in GSM and UMTS, and the MPC, which is defined in ANSI standards. Since the location server should be seen as a logical entity, other implementations are possible.

In the scenarios (except where explicitly mentioned) an LCS client initiates the dialogue by sending a query to the location server and the server responds to the query.

5.1.1 MLP structure

Different devices may support different means of communication. A ubiquitous protocol for location services should support different transport mechanisms.

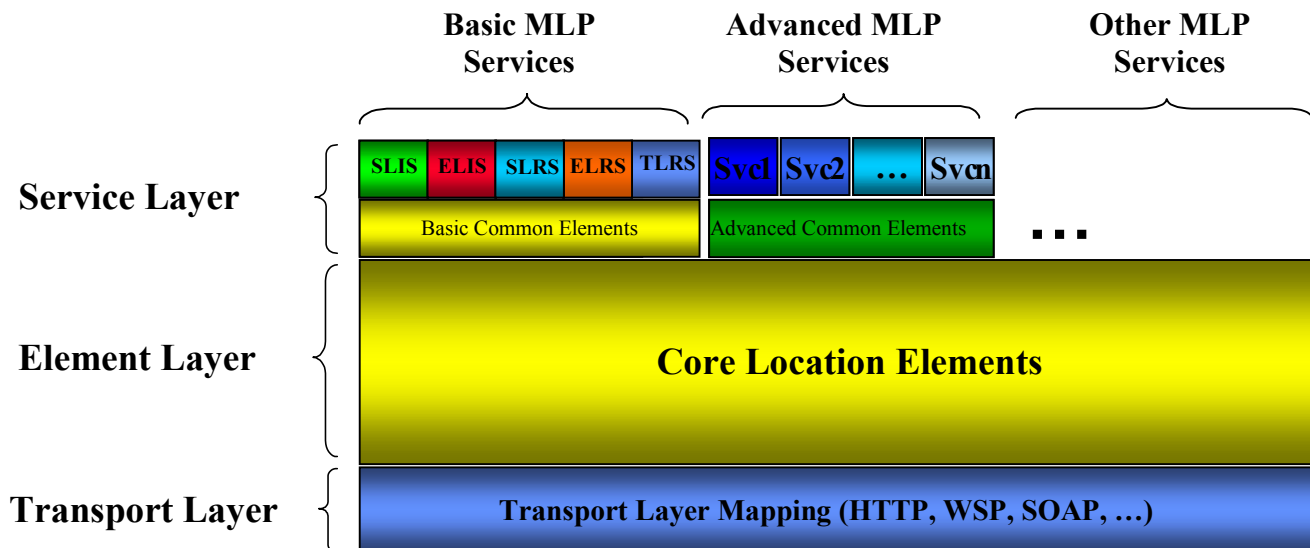

Figure 2: MLP Structure

In MLP, the transport protocol is separated from the XML content. Figure 2 shows a layered view of MLP.

On the lowest level, the transport protocol defines how XML content is transported. Possible MLP transport protocols include HTTP, WSP, SOAP and others.

The Element Layer defines all common elements used by the services in the service layer. Currently MLP defines the following set of DTDs making up the element layer of MLP:

MLP_ID.DTD	Identify Element Definitions
MLP_FUNC.DTD	Function Element Definitions
MLP_LOC.DTD	Location Element Definitions
MLP_RES.DTD	Result Element Definitions
MLP_SHAPE.DTD	Shape Element Definitions
MLP_QOP.DTD	Quality of Position Element Definitions
MLP_GSM_NET.DTD	GSM Network Parameters Element Definitions
MLP_CTXT.DTD	Context Element Definitions

The Service Layer defines the actual services offered by the MLP framework. Basic MLP Services are based on location services defined by 3GPP, and are defined by this specification. The "Advanced MLP Services" and "Other MLP Services" are additional services that either will be specified in other specifications or are specified by other fora that conform to the MLP framework.

Note: The boxes representing services in the Service Layer may contain more than one message. E.g. SLIS (Standard Location Immediate Service) consists of slir (Standard Location Immediate Request), slia (Standard Location Immediate Answer) and slirep (Standard Location Immediate Report) messages. Messages for each service are listed in the table below.

The Service Layer is divided into two sub-layers. The topmost defines the services mentioned in the previous paragraph. The lower sub-layer holds common elements, which are specific for that group of services. If an element is common to more than one group of services then that element is defined in the element layer. The present specification specifies no element sub-layer.

There are a number of different possible types of location services. Each implementation of location server can select which services it wants/needs to support. The services are described in the table below.

Service	Description
Standard Location Immediate Service	This is a standard query service with support for a large set of parameters. This service is used when a (single) location response is required immediately (within a set time) or the request may be served by several asynchronous location responses (until a predefined timeout limit is reached). This service consists of the following messages: <ul style="list-style-type: none"> - Standard Location Immediate Request - Standard Location Immediate Answer - Standard Location Immediate Report
Emergency Location Immediate Service	This is a service used especially for querying of the location of a mobile subscriber that has initiated an emergency call. The response to this service is required immediately (within a set time) or the request may be served by several asynchronous location responses. This service consists of the following messages: <ul style="list-style-type: none"> - Emergency Location Immediate Request

	<ul style="list-style-type: none"> - Emergency Location Immediate Answer - Emergency Location Immediate Report
Standard Location Reporting Service	<p>This is a service that is used when a mobile subscriber wants an LCS Client to receive the MS location. The position is sent to the LCS Client from the location server. Which LCS application and its address are specified by the MS or defined in the location server.</p> <p>This service consists of the following message:</p> <ul style="list-style-type: none"> - Standard Location Report - Standard Location Report Answer
Emergency Location Reporting Service	<p>This is a service that is used when the wireless network automatically initiates the positioning at an emergency call. The position and related data is then sent to the emergency application from the location server. Which LCS application and its address are defined in the location server.</p> <p>This service consists of the following message:</p> <ul style="list-style-type: none"> - Emergency Location Report
Triggered Location Reporting Service	<p>This is a service used when the mobile subscriber's location should be reported at a specific time interval or on the occurrence of a specific event.</p> <p>This service consists of the following messages:</p> <ul style="list-style-type: none"> - Triggered Location Reporting Request - Triggered Location Reporting Answer - Triggered Location Report - Triggered Location Reporting Stop Request - Triggered Location Reporting Stop Answer

5.1.2 MLP extension mechanism

The MLP specification has been designed with extensibility in mind. Examples of design principles employed to achieve this include:

- Separate DTDs for definitions that are common to all messages, e.g. client address and shapes, so they can be re-used.
- A message extension mechanism allowing the addition of new messages (specific for the HTTP mapping). This mechanism works by specifying an entity parameter, '%extension;', referring to an extension DTD. The extension DTD MUST contain another entity parameter, '%extension.message', containing the definition of the extension as a string together with the actual parameters being added
- A parameter extension mechanism allowing the addition of new parameters to existing messages. This mechanism works by specifying an entity parameter, '%extension;', referring to an extension DTD. The extension DTD MUST contain another entity parameter, '%extension.param', containing the definition of the extension as a string together with the actual messages being added.
- Each extension parameters SHOULD have a vendor specific prefix in order to guarantee their uniqueness.
- Element names defined in MLP SHALL NOT be reused with a different definition.

In order to use the extension, the extension DTD has to be explicitly referenced in the XML document.

The Location Server SHOULD ignore any extension that is not recognized and process the message as if the extension is not available.

Example 1: Message extension

```
<!-- truckco_MLP_extension -->
<!ENTITY % extension.message " | truckco_message">
```

<!ELEMENT	truckco_message	(truckco_data)>
<!ATTLIST	truckco_message	
	ver CDATA	#FIXED "x.y.z">

```
<?xml version = "1.0" ?>
<!DOCTYPE svc_init SYSTEM "MLP_SVC_INIT_320.DTD" [
  <!ENTITY % extension SYSTEM
    "http://www.truckco.com/truckco_MLP_extension.dtd">
  %extension;
]>
<svc_init ver="3.3.0">
  <hdr ver="3.3.0">
    ...
  </hdr>
  <truckco_message ver="x.y.z">
    <truckco_data>
      ...
    </truckco_data>
  </truckco_message>
</svc_init>
```

Example 2: Parameter extension (note that “truckco_codeword” is given with a vendor specific prefix as the element “codeword” has a different definition than in MLP)

<!-- truckco_MLP_extension -->		
<!ENTITY	% extension.param	", truckco_extension">
<!ELEMENT	truckco_extension	(truck_no, truckco_codeword)>
<!ELEMENT	truck_no	(#PCDATA)>
<!ELEMENT	truckco_codeword	(#PCDATA)>
<!ATTLIST	truckco_codeword	
	type (long short)	#REQUIRED>

```
<?xml version = "1.0" ?>
<!DOCTYPE svc_init SYSTEM "MLP_SVC_INIT_320.DTD" [
  <!ENTITY % extension SYSTEM
    "http://www.truckco.com/truckco_MLP_extension.dtd">
  %extension;
]>
<svc_init ver="3.3.0">
  <hdr ver="3.3.0">
    ...
  </hdr>
  <slir ver="3.3.0">
    ...
    <truckco_extension>
      <truck_no>KLM4583</truck_no>
      <truckco_codeword type="short">6547</truckco_codeword>
    </truckco_extension>
  </slir>
</svc_init>
```

5.2 Mobile Location Service Definitions

5.2.1 Transport Protocol Layer Definitions

MLP can be implemented using various transport mechanism as stated in section 5.1.1. The following mappings are specified for MLP:

Mapping	Section
HTTP	5.6 HTTP Mapping

5.2.2 Element Layer Definitions

5.2.2.1 Identity Element Definitions

```

<!-- MLP_ID -->
<!--
MLP V3.3 Document Type Definition

Copyright Open Mobile Alliance Ltd., 2005
    All rights reserved

MLP is an XML language. Typical usage:
    <?xml version="1.0"?>
    <!DOCTYPE svc_xxx PUBLIC "-//OMA//DTD {abbrev x.y}//EN"
        "http://www.openmobilealliance.org/DTD/{filename}"
        [<?oma-{ref}-ver supported-versions="{versions}"?>]>
    <svc_xxx>
        ...
    </svc_xxx>

Terms and conditions of use are available from the
Open Mobile Alliance Ltd. web site at
http://www.openmobilealliance.org/
-->

<!ELEMENT   msid                (#PCDATA)>
<!ATTLIST  msid
    type (MSISDN | IMSI | IMEI | MIN | MDN |
          EME_MSID | ASID | OPE_ID | IPV4 | IPV6 |
          SESSID | SIP_URI | TEL_URL | NAI)
          "MSISDN"
    enc (ASC | CRP)
          "ASC">
<!ELEMENT  msid_range          (start_msid, stop_msid)>
<!ELEMENT  msids                ((msid, codeword?, session?,
                                trans_id?) | (msid_range,
                                codeword*))>

<!ELEMENT  codeword            (#PCDATA)>
<!ELEMENT  esrd                (#PCDATA)>
<!ATTLIST  esrd
    type (NA)
          "NA">
<!ELEMENT  esrk                (#PCDATA)>
<!ATTLIST  esrk
    type (NA)
          "NA">
<!ELEMENT  session             (#PCDATA)>
<!ATTLIST  session
    type (APN | DIAL)
          #REQUIRED>
<!ELEMENT  start_msid          (msid)>
<!ELEMENT  stop_msid           (msid)>
<!ELEMENT  trans_id            (#PCDATA)>

```

Note: The type attributes of the msid elements that form the start_msid and stop_msid elements MUST be the same.

5.2.2.2 Function Element Definitions

```

<!-- MLP_FUNC -->
<!--
MLP V3.3 Document Type Definition

Copyright Open Mobile Alliance Ltd., 2008
    All rights reserved

MLP is an XML language. Typical usage:
  <?xml version="1.0"?>
    <!DOCTYPE svc_init PUBLIC "-//OMA//DTD {abbrev x.y}//EN"
      "http://www.openmobilealliance.org/DTD/{filename}"
      [<?oma-{ref}-ver supported-versions="{versions}"?>]>
    <svc_init>
      ...
    </svc_init>

Terms and conditions of use are available from the
Open Mobile Alliance Ltd. web site at
http://www.openmobilealliance.org/
-->

<!ELEMENT   eme_event                (eme_pos+)>
<!ATTLIST  eme_event
  eme_trigger (EME_ORG | EME_REL)      #REQUIRED>
<!ELEMENT  tlrr_event                (ms_action | change_area)>
<!ELEMENT  ms_action                 EMPTY>
<!ATTLIST  ms_action
  type (MS_AVAIL)                     #REQUIRED>
<!ELEMENT  change_area               (target_area, no_of_reports?)>
<!ATTLIST  change_area
  type (MS ENTERING | MS LEAVING | MS WITHIN AREA |
  MS_OUTSIDE_AREA)                   #REQUIRED
  loc_estimates (TRUE | FALSE)       #REQUIRED>
<!ELEMENT  target_area                (shape | cc | plmn | name_area)>
<!ELEMENT  no_of_reports              (#PCDATA)>
<!ELEMENT  name_area                  (#PCDATA)>
<!ELEMENT  plmn                       (mcc, mnc)>
<!ELEMENT  interval                   (#PCDATA)>
<!ELEMENT  loc_type                   batch_cond?>
<!ATTLIST  loc_type
  type (CURRENT | LAST | CURRENT_OR_LAST |
  LAST_OR_CURRENT | INITIAL |
  CURRENT_AND_INTERMEDIATE)          "CURRENT"
  per_type (REALTIME | QUASIREALTIME | BATCH) "REALTIME">
<!ELEMENT  batch_cond                 (#PCDATA)>
<!ATTLIST  batch_cond
  batch_type (MEASUREMENTS | MINUTES | ENDOFSERVICE
  ) "ENDOFERVICE">
<!ELEMENT  prio                       EMPTY>
<!ATTLIST  prio
  type (NORMAL | HIGH)               "NORMAL">
<!ELEMENT  pushaddr                   (url, id?, pwd?)>

```

<!ELEMENT	req_id	(#PCDATA)>
<!ELEMENT	start_time	(#PCDATA)>
<!ATTLIST	start_time	
	utc_off CDATA	"0000">
<!ELEMENT	stop_time	(#PCDATA)>
<!ATTLIST	stop_time	
	utc_off CDATA	"0000">
<!ELEMENT	duration	(#PCDATA)>
<!ELEMENT	url	(#PCDATA)>
<!ELEMENT	time_remaining	(#PCDATA)>
<!ELEMENT	lcs_ref	(#PCDATA)>
<!ELEMENT	supl_support_params	(ip_address?, shape?)>
<!ELEMENT	ip_address	(#PCDATA)>

5.2.2.3 Location Element Definitions

```

<!-- MLP_LOC -->
<!--
MLP V3.3 Document Type Definition

Copyright Open Mobile Alliance Ltd., 2008
All rights reserved

MLP is an XML language. Typical usage:
  <?xml version="1.0"?>
  <!DOCTYPE svc_xxx PUBLIC "-//OMA//DTD {abbrev x.y}//EN"
    "http://www.openmobilealliance.org/DTD/{filename}"
    [<?oma-{ref}-ver supported-versions="{versions}"?>]>
  <svc_xxx>
    ...
  </svc_xxx>

Terms and conditions of use are available from the
Open Mobile Alliance Ltd. web site at
http://www.openmobilealliance.org/
-->

<!ELEMENT    pos                (msid, (pd | poserr),
                                gsm_net_param?, trans_id?)>
<!ATTLIST   pos
  pos_method (CELL | OTDOA | GPS | A-GPS | GNSS |
             A-GNSS | E-OTD | U-TDOA | AFLT | EFLT | E-CID |
             UNKNOWN | OTHER)          #IMPLIED
  result_type (INTERMEDIATE | FINAL)  "FINAL">
<!ELEMENT   eme_pos            (msid, (pd | poserr), esrd?,
                                esrk?, trans_id?)>
<!ATTLIST   eme_pos
  pos_method (CELL | OTDOA | GPS | A-GPS | GNSS |
             A-GNSS | E-OTD | U-TDOA | AFLT | EFLT | E-CID |
             UNKNOWN | OTHER)          #IMPLIED
  result_type (INTERMEDIATE | FINAL)  "FINAL">
<!ELEMENT   trl_pos            (msid, (pd | poserr | time))>
<!ATTLIST   trl_pos
  trl_trigger (PERIODIC | MS_AVAIL | CHANGE_AREA) #REQUIRED
  pos_method (CELL | OTDOA | GPS | A-GPS | E-OTD
             | U-TDOA | AFLT | EFLT | E-CID | UNKNOWN |
             OTHER)                    #IMPLIED>
<!ELEMENT   pd                (time, (shape | civicloc | (shape,

```

	civicloc)), MapData?, (alt, alt unc?)?, speed?, direction?, lev_conf?, qos_not_met?)>
<!ELEMENT poserr	(result, add_info?, time)>
<!ELEMENT MapData	(Base64Map Url)>
<!ELEMENT Base64Map	(#PCDATA)>
<!ELEMENT Url	(#PCDATA)>
<!ELEMENT MapRequest	(Width?, Height?, Zoom?)>
<!ATTLIST MapRequest	
MapdataType (MAP URL)	"MAP"
MimeType (GIF JPEG PNG TIFF)	"GIF">
<!ELEMENT Width	(#PCDATA)>
<!ELEMENT Height	(#PCDATA)>
<!ELEMENT Zoom	(#PCDATA)>
<!ATTLIST Zoom	
ZoomType (KILOMETER METER MILE INCH)	"KILOMETER">
<!ELEMENT time	(#PCDATA)>
<!ATTLIST time	
utc_off CDATA	"0000">
<!ELEMENT alt	(#PCDATA)>
<!ELEMENT alt_unc	(#PCDATA)>
<!ELEMENT civicloc	(civicloc_element+)>
<!ATTLIST civicloc	
xml:lang CDATA	#IMPLIED>
civicloc_element	(#PCDATA)>
<!ATTLIST civicloc_element	
element_type (COUNTRY A1 A2 A3 A4 A5 A6 PRD POD STS HNO HNS LMK LOC FLR NAM PC BLD UNIT ROOM PLC PCN POBOX ADDCODE SEAT RD RDSEC RDBR RDSUBBR PRM POM)	#REQUIRED
xml:lang CDATA	#IMPLIED>
<!ELEMENT qos_not_met	EMPTY>
<!ELEMENT direction	(#PCDATA)>
<!ELEMENT speed	(#PCDATA)>
<!ELEMENT lev_conf	(#PCDATA)>
<!ELEMENT geo_info	(CoordinateReferenceSystem)>
<!ATTLIST geo_info	
requested_positiondata (SHAPE CIVICLOC SHAPE_AND_CIVICLOC)	"SHAPE"
Strict (YES NO)	"YES">
<!ELEMENT CoordinateReferenceSystem	(Identifier)>
<!ELEMENT Identifier	(code, codeSpace, edition)>
<!ELEMENT code	(#PCDATA)>
<!ELEMENT codeSpace	(#PCDATA)>
<!ELEMENT edition	(#PCDATA)>
<!ELEMENT service_coverage	((cc, ndc*)+)>

Examples of geo_info encoding.

The encoding for WGS84 is:

```
<CoordinateReferenceSystem>
  <Identifier>
    <code>4326</code>
    <codeSpace>EPSG</codeSpace>
```

```

    <edition>6.1</edition>
  </Identifier>
</CoordinateReferenceSystem>

```

The encoding for the Transverse Mercator coordinate system based on the OSGB1936 is:

```

<CoordinateReferenceSystem>
  <Identifier>
    <code>27700</code>
    <codeSpace>EPSG</codeSpace>
    <edition>6.1</edition>
  </Identifier>
</CoordinateReferenceSystem>

```

Note that the GML V2.1.1 Implementation Specification is limited to use of only well-known CRSs, so this XML is currently abbreviated by a single attribute name and value:

```
srsName=http://www.opengis.net/gml/srs/epsg.xml#4326
```

Note also that GML uses crsName instead of srsName.

Note that GPS or A-GPS indicates no other GNSS is used or to be used. GNSS or A-GNSS indicates at least one GNSS or A-GNSS and may include GPS or A-GPS used or to be used.

5.2.2.4 Result Element Definitions

```

<!-- MLP_RES -->
<!--
MLP V3.3 Document Type Definition

Copyright Open Mobile Alliance Ltd., 2002
    All rights reserved

MLP is an XML language. Typical usage:
  <?xml version="1.0"?>
  <!DOCTYPE svc_result PUBLIC "-//OMA//DTD {abbrev x.y}//EN"
    "http://www.openmobilealliance.org/DTD/{filename}"
    [<?oma-{ref}-ver supported-versions="{versions}"?>]>
  <svc_result>
    ...
  </svc_result>

Terms and conditions of use are available from the
Open Mobile Alliance Ltd. web site at
http://www.openmobilealliance.org/
-->

<!ELEMENT   add_info           (#PCDATA)>
<!ELEMENT   result             (#PCDATA)>
<!ATTLIST   result
  resid CDATA                  #REQUIRED>

```

5.2.2.5 Shape Element Definitions

```

<!-- MLP_SHAPE -->
<!--
MLP V3.3 Document Type Definition

Copyright Open Mobile Alliance Ltd., 2005
All rights reserved

MLP is an XML language. Typical usage:
  <?xml version="1.0"?>
  <!DOCTYPE svc_result PUBLIC "-//OMA//DTD {abbrev x.y}//EN"
    "http://www.openmobilealliance.org/DTD/{filename}"
    [<?oma-{ref}-ver supported-versions="{versions}"?>]>
  <svc_result>
    ...
  </svc_result>

Terms and conditions of use are available from the
Open Mobile Alliance Ltd. web site at
http://www.openmobilealliance.org/
-->

<!ELEMENT   shape                (Point | LineString | Polygon |
                                Box | CircularArea |
                                CircularArcArea |
                                EllipticalArea |
                                MultiLineString | MultiPoint |
                                MultiPolygon| LinearRing)>

<!ELEMENT   distanceUnit        (#PCDATA)>
<!ELEMENT   angularUnit         (#PCDATA)>
<!ELEMENT   angle               (#PCDATA)>
<!ELEMENT   coord               (X, Y?, Z?, Zone?, Hemisphere?)>
<!ELEMENT   X                   (#PCDATA)>
<!ELEMENT   Y                   (#PCDATA)>
<!ELEMENT   Z                   (#PCDATA)>
<!ELEMENT   Zone                (#PCDATA)>
<!ELEMENT   Hemisphere          (#PCDATA)>
<!ELEMENT   Point               (coord)>
<!ATTLIST   Point
            gid ID                #IMPLIED
            srsName CDATA         #IMPLIED>
<!ELEMENT   LineString          (coord, coord+)>
<!ATTLIST   LineString
            gid ID                #IMPLIED
            srsName CDATA         #IMPLIED>
<!ELEMENT   Box                 (coord, coord)>
<!ATTLIST   Box
            gid ID                #IMPLIED
            srsName CDATA         #IMPLIED>
<!ELEMENT   LinearRing          (coord, coord, coord, coord*)>
<!ATTLIST   LinearRing
            gid ID                #IMPLIED
            srsName CDATA         #IMPLIED>
<!ELEMENT   Polygon             (outerBoundaryIs,
                                innerBoundaryIs*)>
<!ATTLIST   Polygon

```

	gid ID	#IMPLIED
	srsName CDATA	#IMPLIED>
<!ELEMENT	outerBoundaryIs	(LinearRing)>
<!ELEMENT	innerBoundaryIs	(LinearRing)>
<!ELEMENT	CircularArcArea	(coord, inRadius, outRadius, startAngle, stopAngle, angularUnit?, distanceUnit?)>
<!ATTLIST	CircularArcArea	
	gid ID	#IMPLIED
	srsName CDATA	#IMPLIED>
<!ELEMENT	CircularArea	(coord, radius, distanceUnit?)>
<!ATTLIST	CircularArea	
	gid ID	#IMPLIED
	srsName CDATA	#IMPLIED>
<!ELEMENT	EllipticalArea	(coord, angle, semiMajor, semiMinor, angularUnit?, distanceUnit?)>
<!ATTLIST	EllipticalArea	
	gid ID	#IMPLIED
	srsName CDATA	#IMPLIED>
<!ELEMENT	inRadius	(#PCDATA)>
<!ELEMENT	outRadius	(#PCDATA)>
<!ELEMENT	radius	(#PCDATA)>
<!ELEMENT	semiMajor	(#PCDATA)>
<!ELEMENT	semiMinor	(#PCDATA)>
<!ELEMENT	startAngle	(#PCDATA)>
<!ELEMENT	stopAngle	(#PCDATA)>
<!ELEMENT	MultiLineString	(LineString+)>
<!ATTLIST	MultiLineString	
	gid ID	#IMPLIED
	srsName CDATA	#IMPLIED>
<!ELEMENT	MultiPoint	(Point+)>
<!ATTLIST	MultiPoint	
	gid ID	#IMPLIED
	srsName CDATA	#IMPLIED>
<!ELEMENT	MultiPolygon	((Polygon Box CircularArea CircularArcArea EllipticalArea)+)>
<!ATTLIST	MultiPolygon	
	gid ID	#IMPLIED
	srsName CDATA	#IMPLIED>

Note also that GML uses crsName instead of srsName.

5.2.2.6 Quality of Position Element Definitions

```

<!-- MLP_QOP -->
<!--
MLP V3.3 Document Type Definition

Copyright Open Mobile Alliance Ltd., 2005
All rights reserved

MLP is an XML language. Typical usage:
  <?xml version="1.0"?>
  <!DOCTYPE svc_init PUBLIC "-//OMA//DTD {abbrev x.y}//EN"
    "http://www.openmobilealliance.org/DTD/{filename}"
    [<?oma-{ref}-ver supported-versions="{versions}"?>]>
  <svc_init>
    ...
  </svc_init>

Terms and conditions of use are available from the
Open Mobile Alliance Ltd. web site at
http://www.openmobilealliance.org/
-->

<!ELEMENT   eqop                (resp_req?, resp_timer?,
                                (ll_acc | hor_acc)?, alt_acc?,
                                max_loc_age?)>
<!ELEMENT   qop                 ((ll_acc | hor_acc)?,
                                alt_acc?)>
<!ELEMENT   ll_acc              (#PCDATA)>
<!ATTLIST   ll_acc
            qos_class (ASSURED | BEST_EFFORT) #IMPLIED>
<!ELEMENT   hor_acc            (#PCDATA)>
<!ATTLIST   hor_acc
            qos_class (ASSURED | BEST_EFFORT) #IMPLIED>
<!ELEMENT   alt_acc            (#PCDATA)>
<!ATTLIST   alt_acc
            qos_class (ASSURED | BEST_EFFORT) #IMPLIED>
<!ELEMENT   max_loc_age        (#PCDATA)>
<!ELEMENT   resp_req           EMPTY>
<!ATTLIST   resp_req
            type (NO_DELAY | LOW_DELAY | DELAY_TOL) "DELAY_TOL">
<!ELEMENT   resp_timer         (#PCDATA)>

```

5.2.2.7 GSM Network Parameters Element Definitions

```

<!-- MLP_GSM_NET -->
<!--
MLP V3.3 Document Type Definition

Copyright Open Mobile Alliance Ltd., 2002
All rights reserved

MLP is an XML language. Typical usage:
  <?xml version="1.0"?>
  <!DOCTYPE svc_xxx PUBLIC "-//OMA//DTD {abbrev x.y}//EN"
    "http://www.openmobilealliance.org/DTD/{filename}"
    [<?oma-{ref}-ver supported-versions="{versions}"?>]>
  <svc_xxx>
    ...
  </svc_xxx>

Terms and conditions of use are available from the
Open Mobile Alliance Ltd. web site at
http://www.openmobilealliance.org/
-->

<!ELEMENT   gsm_net_param          (cgi?, neid?, nmr?, ta?,
                                     lmsi?, imsi?)>
<!ELEMENT   cgi                    (mcc, mnc, lac, cellid)>
<!ELEMENT   neid                    (vlrid |
                                     (vmscid, vlrid?))>
<!ELEMENT   vmscid                  (cc?, ndc?, vmscno)>
<!ELEMENT   vlrid                   (cc?, ndc?, vlrno)>
<!ELEMENT   nmr                     (#PCDATA)>
<!ELEMENT   mcc                     (#PCDATA)>
<!ELEMENT   mnc                     (#PCDATA)>
<!ELEMENT   ndc                     (#PCDATA)>
<!ELEMENT   cc                      (#PCDATA)>
<!ELEMENT   vmscno                  (#PCDATA)>
<!ELEMENT   vlrno                   (#PCDATA)>
<!ELEMENT   lac                     (#PCDATA)>
<!ELEMENT   cellid                  (#PCDATA)>
<!ELEMENT   ta                      (#PCDATA)>
<!ELEMENT   lmsi                    (#PCDATA)>
<!ELEMENT   imsi                   (#PCDATA)>

```

Note: The above table corresponds to GSM specific network element identifiers and network parameters. This information may be considered operator sensitive.

5.2.2.8 Context Element Definitions

```

<!-- MLP_CTXT -->
<!--
MLP V3.3 Document Type Definition

Copyright Open Mobile Alliance Ltd., 2005
All rights reserved

MLP is an XML language. Typical usage:
  <?xml version="1.0"?>
  <!DOCTYPE svc_xxx PUBLIC "-//OMA//DTD {abbrev x.y}//EN"
    "http://www.openmobilealliance.org/DTD/{filename}"
    [<?oma-{ref}-ver supported-versions="{versions}"?>]>
  <svc_xxx>
    ...
  </svc_xxx>

Terms and conditions of use are available from the
Open Mobile Alliance Ltd. web site at
http://www.openmobilealliance.org/
-->
<!ELEMENT   client                (id, pwd?, serviceid?,
requestmode?)>
<!ELEMENT   sessionid            (#PCDATA)>
<!ELEMENT   id                    (#PCDATA)>
<!ELEMENT   requestor            (id, serviceid?)>
<!ATTLIST   requestor
  type (MSISDN | IMSI | NAME | E-MAIL | URL |
SIPURL | IMS | MDN | ASID | ASPID)          "MSISDN">
<!ELEMENT   pwd                  (#PCDATA)>
<!ELEMENT   serviceid            (#PCDATA)>
<!ELEMENT   requestmode          EMPTY>
<!ATTLIST   requestmode
  type (ACTIVE | PASSIVE)                "PASSIVE">
<!ELEMENT   subclient            (id, pwd?, serviceid?)>
<!ATTLIST   subclient
  last_client (YES | NO)                  "NO">

```

5.2.3 Service Layer Definitions

Each message MAY have a header part and SHALL have a body part. The body part consists of the request/answer and is described in sections 5.2.3.2-5.2.3.8. The context or header part consists of the information that identifies the client as defined in section 5.2.3.1.

5.2.3.1 Header Components

The **subclient** elements (if present) identify the ASPs, resellers and portals in the chain of service providers between the network and the end-user. The distinction between **client** and **subclient** elements is that the **client** element identifies the provider of the service that the Location Server has the main relationship with, whereas the **subclient** elements identify the chain of other service providers up to the end-user. The final service provider in the chain is identified as such (`last_client="YES"`). The **requestor** indicates the initiator of the location request, so in this context besides an ASP it could also be an MS subscriber who is asking the position of another target MS. The identity of the **requestor** may be an MSISDN or any other identifier identifying the initiator of the location request.

The **serviceid** element can be present in **client**, **subclient** and **requestor** elements. If the Location Server supports **serviceid** element for privacy checking procedure it SHALL use the **serviceid** element received in the **client** element. The Location Server MAY check that all **serviceid** element received in a location request are consistent and MAY reject a request if not.

The **sessionid** element is used to represent the current session between the LCS Client and the Location Server. It MAY be used to replace the **id** and **pwd** elements, used in the context by the LCS Client to "login" to the Location Server, for the transactions that make up a session. For the first transaction of the session the LCS Client SHALL "login" as usual. The Location Server MAY optionally return the **sessionid** in the response to this first transaction. If the Location Server does not return a **sessionid** the LCS Client SHALL continue to "login" for subsequent transactions. The LCS Client MAY ignore the **sessionid** if desired and continue to "login" for subsequent transactions.

The Location Server will decide the policy to be used to determine how the **sessionid** will be created and maintained. For example, the Location Server may determine the session as being just the transactions pertaining to a single service/MSID combination – this being restrictive and hence secure whilst still being useable, or the Location Server may allow the session to apply to a number of transactions between the Location Server and LCS Client. The Location Server may also allow the **sessionid** to be used for a particular period of time. The Location Server may also decide to return a different **sessionid** on each response, which the LCS Client will then use on the next transaction of the session.

The **sessionid** cannot be used instead of the **req_id** as this latter id refers to a set of reports that have been requested to be delivered from the Location Server to the LCS Client and do not form part of an existing LCS Client to Location Server connection. These reports are delivered by the Location Server "logging in" to the LCS Client for each delivery and the use of a **sessionid**, would allow the security of the LCS Client to be breached.

5.2.3.1.1 Header DTD

```
<!-- MLP_HDR -->
<!--
MLP V3.3 Document Type Definition

Copyright Open Mobile Alliance Ltd., 2005
    All rights reserved

MLP is an XML language. Typical usage:
  <?xml version="1.0"?>
  <!DOCTYPE svc_xxx PUBLIC "-//OMA//DTD {abbrev x.y}//EN"
    "http://www.openmobilealliance.org/DTD/{filename}"
    [<?oma-{ref}-ver supported-versions="{versions}"?>]>
  <svc_xxx>
    ...
  </svc_xxx>

Terms and conditions of use are available from the
Open Mobile Alliance Ltd. web site at
http://www.openmobilealliance.org/
-->

<!ELEMENT   hdr                ((sessionid | (client , sessionid?)), subclient*,
                                requestor?)>
<!ATTLIST  hdr
            ver CDATA           #FIXED "3.3.0">
```

Example 1: ASP as Initiator

```
<hdr ver="3.3.0">
  <client>
    <id>theasp</id>
    <pwd>thepwd</pwd>
    <serviceid>0005</serviceid>
    <requestmode type="PASSIVE"/>
```

```

</client>
<subclient last_client="YES">
  <id>thelastasp</id>
  <serviceid>0005</serviceid>
</subclient>
<requestor>
  <id>theoriginalasp</id>
  <serviceid>0005</serviceid>
</requestor>
</hdr>

```

Example 2: MS as Initiator

```

<hdr ver="3.3.0">
  <client>
    <id>theasp</id>
    <pwd>thepwd</pwd>
    <serviceid>0005</serviceid>
    <requestmode type="ACTIVE"/>
  </client>
  <requestor>
    <id>461018765710</id>
  </requestor>
</hdr>

```

5.2.3.2 Standard Location Immediate Service

This is a standard service for requesting the location of one or more Mobile Subscribers. The service is used when a single location response is required immediately (within a set time) or when several asynchronous location responses can be returned (until a predefined timeout limit is reached).

When a lot of positioning reports are requested, it may take an unacceptably long time to get all the responses from the network. If the Location Server supports it the LCS Client can define how to receive the location responses, either at the time of the response to the request, or individually using one or more connections initiated by the Location Server.

The extended service supports a number of different formats for describing the location of the mobile subscriber. It has also support for requesting a certain Quality of Service, Type of location and priority.

The service consists of the following messages:

- Standard Location Immediate Request
- Standard Location Immediate Answer
- Standard Location Immediate Report

The Standard Location Immediate Service SHALL consist of a Standard Location Immediate Request followed by one Standard Location Immediate Answer and zero, one or more OPTIONAL Standard Location Immediate Reports. Standard Location Immediate Reports can only be returned by Location Server if the attribute "res_type" is set to "ASYNC" by the LCS Client.

The following message flow as depicted in Figure 3 encapsulates this service:

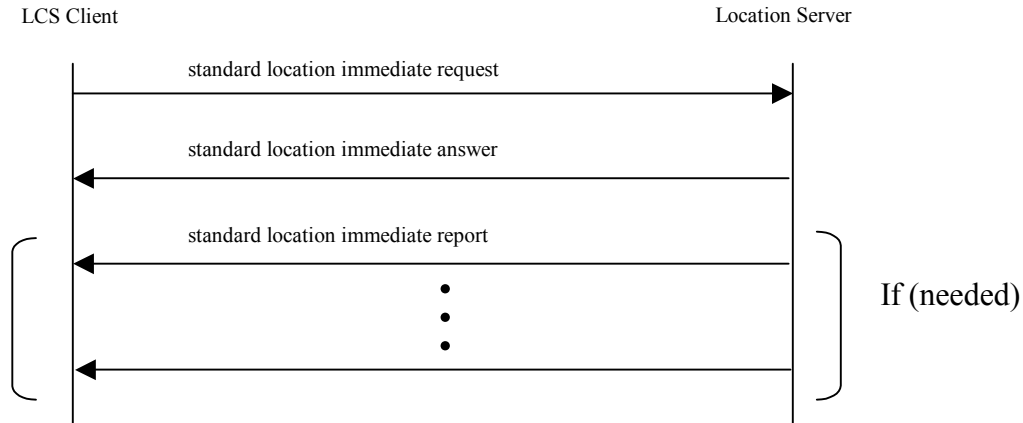

Figure 3: Message Flow for the Standard Location Immediate Service

Note: Multiple Standard Location Immediate Reports can occur when the location information for multiple targets was requested or the request allowed for an intermediate position and the results are reported back to the client in individual reports. An individual report may contain the result of one or more targets. It may also contain an intermediate position, not matching the requested QoP, but of increasing accuracy for each target.

5.2.3.2.1 Standard Location Immediate Request DTD

```

<!-- MLP_SLIR -->
<!--
MLP V3.3 Document Type Definition

Copyright Open Mobile Alliance Ltd., 2005
All rights reserved

MLP is an XML language. Typical usage:
  <?xml version="1.0"?>
  <!DOCTYPE svc_init PUBLIC "-//OMA//DTD {abbrev x.y}//EN"
    "http://www.openmobilealliance.org/DTD/{filename}"
    [<?oma-{ref}-ver supported-versions="{versions}"?>>]
  <svc_init>
    ...
  </svc_init>

Terms and conditions of use are available from the
Open Mobile Alliance Ltd. web site at
http://www.openmobilealliance.org/
-->

<!ENTITY    % extension.param    "">

<!ELEMENT   slir                  ((msids | (msid, codeword?, gsm_net_param, trans_id?)+),
eqop?, geo info?, loc type?, prio?, pushaddr?,
service_coverage?, MapRequest? %extension.param;)>

<!ATTLIST  slir
  ver CDATA          #FIXED "3.3.0"
  res_type (SYNC | ASYNC) "SYNC">
    
```

Example

```

<slir ver="3.3.0" res_type="SYNC">
  <msids>
    <msid type="IPV4">93.10.0.250</msid>
    <msid_range>
      <start_msid>
        <msid>461018765710</msid>
      </start_msid>
      <stop_msid>
        <msid>461018765712</msid>
      </stop_msid>
    </msid_range>
    <msid type="ASID">441728922342</msid>
    <msid_range>
      <start_msid>
        <msid>461018765720</msid>
      </start_msid>
      <stop_msid>
        <msid>461018765728</msid>
      </stop_msid>
    </msid_range>
  </msids>
  <eqop>
    <resp_req type="LOW_DELAY" />
    <hor_acc>1000</hor_acc>
  </eqop>
  <geo_info>
    <CoordinateReferenceSystem>
      <Identifier>
        <code>4004</code>
        <codeSpace>EPSG</codeSpace>
        <edition>6.1</edition>
      </Identifier>
    </CoordinateReferenceSystem>
  </geo_info>
  <loc_type type="CURRENT_OR_LAST" />
  <prio type="HIGH" />
</slir>

```

5.2.3.2.2 Standard Location Immediate Answer DTD

```

<!-- MLP_SLIA -->
<!--
MLP V3.3 Document Type Definition

Copyright Open Mobile Alliance Ltd., 2002
All rights reserved

MLP is an XML language. Typical usage:
<?xml version="1.0"?>
<!DOCTYPE svc_result PUBLIC "-//OMA//DTD {abbrev x.y}//EN"
    "http://www.openmobilealliance.org/DTD/{filename}"
    [<?oma-{ref}-ver supported-versions="{versions}"?>]>
<svc_result>
...
</svc_result>

Terms and conditions of use are available from the
Open Mobile Alliance Ltd. web site at
http://www.openmobilealliance.org/
-->

<!ENTITY % extension.param "">

```



```

<!ELEMENT   slia                               ((pos+ | req_id | (result, add_info?)) %extension.param;)>
<!ATTLIST  slia
            ver CDATA                            #FIXED "3.3.0">

```

Example 1: Successful positioning of multiple subscribers

```

<slia ver="3.3.0" >
  <pos>
    <msid>461011334411</msid>
    <pd>
      <time utc_off="+0200">20020623134453</time>
      <shape>
        <CircularArea srsName="www.epsg.org#4326">
          <coord>
            <X>30 16 28.308N</X>
            <Y>45 15 33.444E</Y>
          </coord>
          <radius>240</radius>
        </CircularArea>
      </shape>
    </pd>
  </pos>
  <pos>
    <msid>461018765710</msid>
    <pd>
      <time utc_off="+0300">20020623134454</time>
      <shape>
        <CircularArea srsName="www.epsg.org#4326">
          <coord>
            <X>30 12 28.296N</X>
            <Y>86 56 33.864E</Y>
          </coord>
          <radius>570</radius>
        </CircularArea>
      </shape>
    </pd>
  </pos>
  <pos>
    <msid>461018765711</msid>
    <pd>
      <time utc_off="+0300">20020623110205</time>
      <shape>
        <CircularArea srsName="www.epsg.org#4326">
          <coord>
            <X>78 12 34.308N</X>
            <Y>76 22 2.82E</Y>
          </coord>
          <radius>15</radius>
        </CircularArea>
      </shape>
    </pd>
  </pos>
  <pos>
    <msid>461018765712</msid>
    <poserr>
      <result resid="10">QOP NOT ATTAINABLE</result>
      <time>20020623134454</time>
    </poserr>
  </pos>
</slia>

```

Example 2: Service not supported

```

<slia ver="3.3.0" >
  <result resid="108">SERVICE NOT SUPPORTED</result>
  <add_info>'slir' is not supported by the location server</add_info>

```

```
</slia>
```

5.2.3.2.3 Standard Location Immediate Report DTD

```
<!-- MLP_SLIREP -->
<!--
MLP V3.3 Document Type Definition

Copyright Open Mobile Alliance Ltd., 2002
All rights reserved

MLP is an XML language. Typical usage:
  <?xml version="1.0"?>
  <!DOCTYPE svc_result PUBLIC "-//OMA//DTD {abbrev x.y}//EN"
    "http://www.openmobilealliance.org/DTD/{filename}"
    [<?oma-{ref}-ver supported-versions="{versions}"?>]>
  <svc_result>
    ...
  </svc_result>

Terms and conditions of use are available from the
Open Mobile Alliance Ltd. web site at
http://www.openmobilealliance.org/
-->

<!ENTITY    % extension.param      "">

<!ELEMENT   slirep                 (req_id, pos+ %extension.param;)>
<!ATTLIST   slirep
  ver CDATA          #FIXED "3.3.0">
```

Example

```
<slirep ver="3.3.0">
  <req_id>25267</req_id>
  <pos>
    <msid type="IPV6">10:A1:45::23:B7:89</msid>
    <pd>
      <time utc_off="+0300">20020813010423</time>
      <shape>
        <CircularArea srsName="www.epsg.org#4326">
          <coord>
            <X>35 03 28.244N</X>
            <Y>135 47 08.711E</Y>
          </coord>
          <radius>15</radius>
        </CircularArea>
      </shape>
    </pd>
  </pos>
</slirep>
```

5.2.3.3 Emergency Location Immediate Service

The emergency location immediate service is used to retrieve the position of a mobile subscriber that is involved in an emergency call or have initiated an emergency service in some other way.

When there is a chance that one location fix may block a location fix which takes a shorter time (eg A-GPS fix and a Cell-ID based fix) then if the Location Server supports it the LCS Client can define how to receive the location responses individually using one or more connections initiated by the Location Server.

The service consists of the following messages:

- Emergency Location Immediate Request
- Emergency Location Immediate Answer
- Emergency Location Immediate Report

The Emergency Location Immediate Service SHALL consist of a Emergency Location Immediate Request followed by one Emergency Location Immediate Answer and zero, one or more OPTIONAL Emergency Location Immediate Reports.

The following message flow as depicted in Figure 4 encapsulates this service:

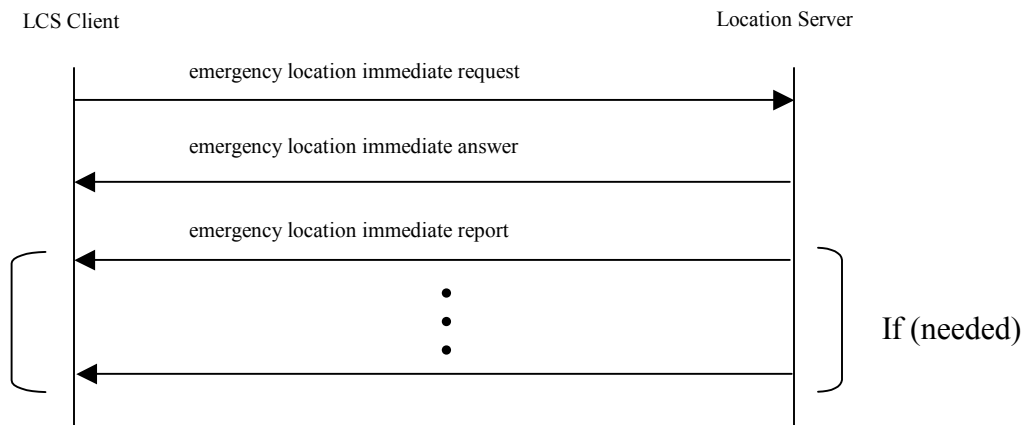

Figure 4: Message Flow for the Emergency Location Immediate Service

Note: Multiple Emergency Location Immediate Reports can occur when the location information for multiple targets was requested or the request allowed for an intermediate position and the results are reported back to the client in individual reports. An individual report may contain the result of one or more targets. It may also contain an intermediate position, not matching the requested QoP, but of increasing accuracy for each target.

5.2.3.3.1 Emergency Location Immediate Request DTD

```
<!-- MLP_EME_LIR -->
```

```

<!--
MLP V3.3 Document Type Definition

Copyright Open Mobile Alliance Ltd., 2005
    All rights reserved

MLP is an XML language. Typical usage:
<?xml version="1.0"?>
  <!DOCTYPE svc_init PUBLIC "-//OMA//DTD {abbrev x.y}//EN"
    "http://www.openmobilealliance.org/DTD/{filename}"
    [<?oma-{ref}-ver supported-versions="{versions}"?>]>
  <svc_init>
    ...
  </svc_init>

Terms and conditions of use are available from the
Open Mobile Alliance Ltd. web site at
http://www.openmobilealliance.org/
-->

<!ENTITY    % extension.param      "">

<!ELEMENT   eme_lir                ((msids | (msid, gsm_net_param, trans_id?, esrd?, esrk? ,
supl_support_params?)+), eqop?, geo_info?, loc_type? ,
pushaddr?, MapRequest? %extension.param;)>

<!ATTLIST   eme_lir
            ver CDATA                #FIXED "3.3.0"
            res_type (SYNC | ASYNC)   "SYNC">

```

Example 1

```

<eme_lir ver="3.3.0">
  <msids>
    <msid type="EME_MSID">520002-51-431172-6-06</msid>
  </msids>
  <geo_info>
    <CoordinateReferenceSystem>
      <Identifier>
        <code>4325</code>
        <codeSpace>EPSG</codeSpace>
        <edition>6.1</edition>
      </Identifier>
    </CoordinateReferenceSystem>
  </geo_info>
  <loc_type type="CURRENT_OR_LAST" />
</eme_lir>

```

Example 2

```

<eme_lir ver="3.3.0" res_type="ASYNc">
  <msids>
    <msid type="EME_MSID">520002-51-431172-6-06</msid>
  </msids>

  <geo_info>
    <CoordinateReferenceSystem>
      <Identifier>
        <code>4326</code>
        <codeSpace>EPSG</codeSpace>
        <edition>6.1</edition>
      </Identifier>
    </CoordinateReferenceSystem>
  </geo_info>
  <loc_type type="CURRENT_OR_LAST" />
  <pushaddr>

```

```

    <url>http://location.application.com</url>
  </pushaddr>
</eme_lir>

```

5.2.3.3.2 Emergency Location Immediate Answer DTD

```

<!-- MLP_EME_LIA -->
<!--
MLP V3.3 Document Type Definition

Copyright Open Mobile Alliance Ltd., 2005
All rights reserved

MLP is an XML language. Typical usage:
  <?xml version="1.0"?>
  <!DOCTYPE svc_result PUBLIC "-//OMA//DTD {abbrev x.y}//EN"
    "http://www.openmobilealliance.org/DTD/{filename}"
    [<?oma-{ref}-ver supported-versions="{versions}"?>]>
  <svc_result>
    ...
  </svc_result>

Terms and conditions of use are available from the
Open Mobile Alliance Ltd. web site at
http://www.openmobilealliance.org/
-->

<!ENTITY    % extension.param      "">

<!ELEMENT   eme_lia                ((eme_pos+ | req_id | (result, add_info?))
                                     %extension.param;)>

<!ATTLIST   eme_lia
  ver CDATA          #FIXED "3.3.0">

```

Example

```

<eme_lia ver="3.3.0">
  <eme_pos>
    <msid type="EME_MSID">520002-51-431172-6-06</msid>
    <pd>
      <time utc_off="+0300">20020623134453</time>
      <shape>
        <CircularArea srsName="www.epsg.org#4326">
          <coord>
            <X>30 24 43.53N</X>
            <Y>45 28 09.534W</Y>
          </coord>
          <radius>15</radius>
        </CircularArea>
      </shape>
    </pd>
    <esrk>7839298236</esrk>
  </eme_pos>
</eme_lia>

```

5.2.3.3.3 Emergency Location Immediate Report DTD

```

<!-- MLP_EME_LIREP -->
<!--
MLP V3.3 Document Type Definition

Copyright Open Mobile Alliance Ltd., 2005
    All rights reserved

MLP is an XML language. Typical usage:
    <?xml version="1.0"?>
    <!DOCTYPE svc_result PUBLIC "-//OMA//DTD {abbrev x.y}//EN"
        "http://www.openmobilealliance.org/DTD/{filename}"
        [<?oma-{ref}-ver supported-versions="{versions}"?>]>
    <svc_result>
        ...
    </svc_result>

Terms and conditions of use are available from the
Open Mobile Alliance Ltd. web site at
http://www.openmobilealliance.org/
-->

<!ENTITY    % extension.param        "">

<!ELEMENT   eme_lirep                (req_id, (eme_pos+ | (result, add_info?))
                                     %extension.param;)>

<!ATTLIST   eme_lirep
    ver CDATA                            #FIXED "3.3.0">

```

Example

```

<eme_lirep ver="3.3.0">
  <req_id>25687</req_id>
  <eme_pos>
    <msid type="EME_MSID">520002-51-431172-6-06</msid>
    <pd>
      <time utc_off="+0300">20020623134453</time>
      <shape>
        <CircularArea srsName="www.epsg.org#4326">
          <coord>
            <X>30 24 43.53N</X>
            <Y>45 28 09.534W</Y>
          </coord>
          <radius>15</radius>
        </CircularArea>
      </shape>
    </pd>
    <esrk>7839298236</esrk>
  </eme_pos>
</eme_lirep>

```

5.2.3.4 Standard Location Reporting Service

When a mobile subscriber wants an LCS client to receive the MS location, e.g. by initiating a MO-LR procedure according to [23.271], a standard location report is generated. The LCS Client that the location report should be sent to SHALL be specified by the MS or defined within the Location Server.

The service consists of the following message:

- Standard Location Report
- Standard Location Report Answer

The Standard Location Reporting Service SHALL consist of one Standard Location Report followed by one Standard Location Report Answer.

The following message flow as depicted in Figure 5 encapsulates this service:

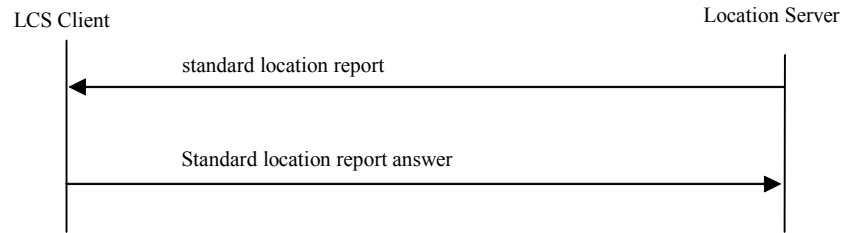

Figure 5: Message flow for the Standard Location Reporting Service

5.2.3.4.1 Standard Location Report DTD

```

<!-- MLP_SLREP -->
<!--
MLP V3.3 Document Type Definition

Copyright Open Mobile Alliance Ltd., 2002
All rights reserved

MLP is an XML language. Typical usage:
<?xml version="1.0"?>
<!DOCTYPE svc_result PUBLIC "-//OMA//DTD {abbrev x.y}//EN"
"http://www.openmobilealliance.org/DTD/{filename}"
[<?oma-{ref}-ver supported-versions="{versions}"?>]>
<svc_result>
...
</svc_result>

Terms and conditions of use are available from the
Open Mobile Alliance Ltd. web site at
http://www.openmobilealliance.org/
-->

<!ENTITY % extension.param "">

<!ELEMENT slrep (pos+ %extension.param;)>
<!ATTLIST slrep
ver CDATA #FIXED "3.3.0">
    
```

Example

```

<slrep ver="3.3.0">
  <pos>
    <msid>461011678298</msid>
    <pd>
      <time>20020813010423</time>
    <shape>
    
```

```

    <CircularArea srsName="www.epsg.org#4326">
      <coord>
        <X>30 45 35.41N</X>
        <Y>45 32 55.02E</Y>
      </coord>
      <radius>15</radius>
    </CircularArea>
  </shape>
</pd>
</pos>
</slrep>

```

5.2.3.4.2 Standard Location Report Answer DTD

```

<!-- MLP_SLRA -->
<!--
MLP V3.3 Document Type Definition

Copyright Open Mobile Alliance Ltd., 2005
All rights reserved

MLP is an XML language. Typical usage:
<?xml version="1.0"?>
<!DOCTYPE svc_result PUBLIC "-//OMA//DTD {abbrev x.y}//EN"
    "http://www.openmobilealliance.org/DTD/{filename}"
    [?oma-{ref}-ver supported-versions="{versions}"?>]>
<svc_result>
    ...
</svc_result>

Terms and conditions of use are available from the
Open Mobile Alliance Ltd. web site at
http://www.openmobilealliance.org/useterms.html
-->

<!ENTITY    % extension.param      "">

<!ELEMENT   slra                    ((result, add_info?) %extension.param;)>
<!ATTLIST   slra                    ver CDATA          #FIXED "3.3.0">

```

Example 1: SLRA in case the handling of corresponding SLREP was successful

```

<slra ver="3.3.0">
  <result resid="0">OK</result>
</slra>

```

Example 2: SLRA in case the handling of corresponding SLREP was in error

```

<slra ver="3.3.0">
  <result resid="4">UNKNOWN SUBSCRIBER</result>
  <add_info> the subscriber is not registered in the LCS Client</add_info>
</slra>

```

5.2.3.5 Emergency Location Reporting Service

If the wireless network initiates a positioning because a user initiates or releases an emergency call, an emergency location report is generated. The application(s) that the emergency location report should be sent to SHALL be defined within the location server. Data as required geographical format and address to application SHALL also be defined within the location server.

The service consists of the following message:

- Emergency Location Report

The Emergency Location Reporting Service SHALL consist one Emergency Location Report.

The following message flow as depicted in Figure 6 encapsulates this service:

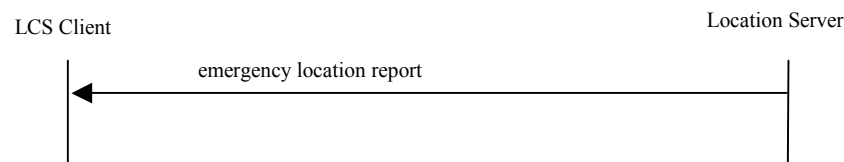

Figure 6: Message Flow for the Emergency Location Reporting Service

5.2.3.5.1 Emergency Location Report DTD

```

<!-- MLP_EMEREP -->
<!--
MLP V3.3 Document Type Definition

Copyright Open Mobile Alliance Ltd., 2002
All rights reserved

MLP is an XML language. Typical usage:
  <?xml version="1.0"?>
  <!DOCTYPE svc_result PUBLIC "-//OMA//DTD {abbrev x.y}//EN"
    "http://www.openmobilealliance.org/DTD/{filename}"
    [<?oma-{ref}-ver supported-versions="{versions}"?>]>
  <svc_result>
    ...
  </svc_result>

Terms and conditions of use are available from the
Open Mobile Alliance Ltd. web site at
http://www.openmobilealliance.org/
-->

<!ENTITY    % extension.param    "">

<!ELEMENT   emerep                (eme_event %extension.param;)>
<!ATTLIST   emerep                ver CDATA          #FIXED "3.3.0">
  
```

Example

```
<emerep ver="3.3.0">
```

```

<eme_event eme_trigger="EME_ORG">
  <eme_pos>
    <msid>461011678298</msid>
    <pd>
      <time utc_off="+0300">20020623010003</time>
      <shape>
        <CircularArea srsName="www.epsg.org#4326">
          <coord>
            <X>30 27 45.3N</X>
            <Y>45 25 50.78E</Y>
          </coord>
          <radius>15</radius>
        </CircularArea>
      </shape>
    </pd>
  </eme_pos>
</eme_event>
</emerep>

```

5.2.3.6 Triggered Location Reporting Service

The triggered location reporting service is used when an application wants the position of several MSs to be tracked. The triggers could be:

- The periodicity of reporting defined by an interval time
- An MS action, defined as the event "UE available" in 3GPP [23.271].
- A Change of Area, defined as the event "change of area" in 3GPP [23.271].

The report will be triggered when one of the pre-defined MS's actions occurred or the time interval elapses. If reporting is based on an interval the reporting can be also be defioned to utilize quasirealtime and batch reporting modes. In quasirealtime mode, reports are not sent if the target has become unavailable but are instead sent at later time when location information has become available. In batch reporting modes the request includes a condition when reports shall be sent. The condition can be a number of measurement, a time expressed in minutes or when the service terminates.

The service consists of the following messages:

- Triggered Location Reporting Request
- Triggered Location Reporting Answer
- Triggered Location Report
- Triggered Location Reporting Stop Request
- Triggered Location Reporting Stop Answer

The Triggered Location Reporting Service SHALL consist of a Triggered Location Reporting Request followed by one Triggered Location Reporting Answer and zero, one or more OPTIONAL Triggered Location Reports.

The Triggered Location Reporting Service MAY also include Triggered Location Reporting Stop Request that, then SHALL be followed by one Triggered Location Reporting Stop Answer. This Triggered Location Reporting Stop Request MAY allow stopping triggered location reporting for any individual target(s) included in the Triggered Location Reporting Request. Additionally a Triggered Location Reporting Stop Answer MAY be sent without preceeding Triggered Location Reporting Stop Request.

The following message flow as depicted in Figure 7 encapsulates this service:

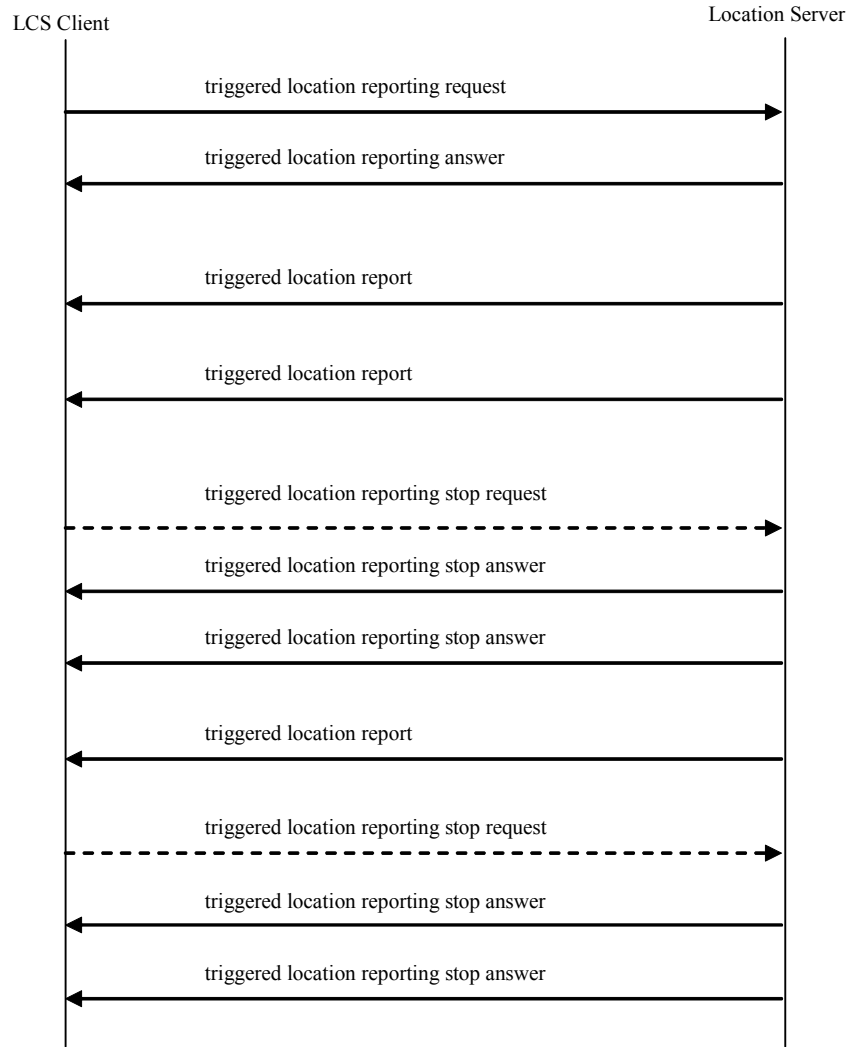

Figure 7: Message Flow for the Triggered Location Reporting Service

Note:

If the network unilaterally decides to terminate the location reporting, the stop reporting information SHALL be carried in a tlrep.

The cancellation of triggered location reporting request could be initiated by the Location Server itself for some reasons such as privacy profile update. In this case a tlrsa MAY be sent without a preceding tlrsr.

5.2.3.6.1 Triggered Location Reporting Request DTD

```

<!-- MLP_TLRR -->
<!--
MLP V3.3 Document Type Definition

Copyright Open Mobile Alliance Ltd., 2005
All rights reserved

MLP is an XML language. Typical usage:
  <?xml version="1.0"?>
  <!DOCTYPE svc_init PUBLIC "-//OMA//DTD {abbrev x.y}//EN"
    "http://www.openmobilealliance.org/DTD/{filename}"
    [?oma-{ref}-ver supported-versions="{versions}"?>>
  <svc_init>
    ...
  </svc_init>

Terms and conditions of use are available from the
Open Mobile Alliance Ltd. web site at
http://www.openmobilealliance.org/
-->

<!ENTITY    % extension.param      "">

<!ELEMENT   tlrr                    (msids, interval?, start_time?, stop_time?, duration?,
tlrr_event?, qop?, geo_info?, pushaddr?, loc_type?, prio?,
service_coverage?, MapRequest? %extension.param;)>

<!ATTLIST   tlrr
            ver CDATA                #FIXED "3.3.0">

```

The following rules apply to the use of 'start_time', 'stop_time', 'interval', 'duration' and 'tlrr_event':

- TLRR with 'interval' SHALL be interpreted as a request for periodic location reports, and TLRR with 'tlrr_event' SHALL be interpreted as a request for a location report on the occurrence of a specific event. 'interval' and 'tlrr_event' MAY be combined for combined periodic and event based location request. When neither 'interval' nor 'tlrr_event' is specified in TLRR, the Location Server MUST reject the request with an error indication '106' to the client.
- If no START_TIME is specified reporting SHALL start immediately.
- If no STOP_TIME is specified the reporting SHOULD occur until explicitly canceled with 'Triggered Location Stop Request' or a time out occurs (depending on system configuration). Timeout MAY be reported to the LCS client by 'time_remaining' in triggered location report.
- If STOP_TIME and Duration are both presented in one request, the Location Server MUST reject the request with an error indication '110' to the client.
- If START_TIME is 'older' than the current time then the Location Server MUST reject the request with an error indication '110' to the client.
- If STOP_TIME is 'older' than then current time then the Location Server MUST reject the request with an error indication '110' to the client.
- If STOP_TIME is earlier than START_TIME then the implementation MUST reject the request with an error indication '110' to the client.
- If STOP_TIME is equal to START_TIME then the Location Server MUST return a single location report to the client at the specified time. Any interval specified MUST be ignored.
- If Duration is specified as zero the Location Server MUST return a single location report to the client at the specified time. Any interval specified MUST be ignored.

The (optional) parameter 'service_coverage' is only allowed for plain periodic requests, i.e. not for event-related requests like MS_Available triggers or area triggers.

Example 1: TLRR for periodic location reports during a period specified by 'start_time' and 'stop_time'

```
<tlrr ver="3.3.0">
  <msids>
    <msid>461011678298</msid>
  </msids>
  <interval>00003000</interval>
  <start_time utc_off="+0300">20021003112700</start_time>
  <stop_time utc_off="+0300">20021003152700</stop_time>
  <qop>
    <hor_acc>100</hor_acc>
  </qop>
  <geo_info>
    <CoordinateReferenceSystem>
      <Identifier>
        <code>4326</code>
        <codeSpace>EPSG</codeSpace>
        <edition>6.1</edition>
      </Identifier>
    </CoordinateReferenceSystem>
  </geo_info>
  <pushaddr>
    <url>http://location.application.com</url>
  </pushaddr>
  <loc_type type="CURRENT" />
  <prio type="HIGH" />
</tlrr>
```

Example 2: TLRR for single location report at a specified time. 'stop_time' is specified equal to 'start_time'.

```
<tlrr ver="3.3.0">
  <msids>
    <msid>461011678298</msid>
  </msids>
  <interval>00003000</interval>
  <start_time utc_off="+0300">20021003112700</start_time>
  <stop_time utc_off="+0300">20021003112700</stop_time>
  <qop>
    <hor_acc>100</hor_acc>
  </qop>
  <geo_info>
    <CoordinateReferenceSystem>
      <Identifier>
        <code>4004</code>
        <codeSpace>EPSG</codeSpace>
        <edition>6.1</edition>
      </Identifier>
    </CoordinateReferenceSystem>
  </geo_info>
  <pushaddr>
    <url>http://location.application.com</url>
  </pushaddr>
  <loc_type type="CURRENT" />
  <prio type="HIGH" />
</tlrr>
```

Example 3: TLRR for a location report on the occurrence of a MS_AVAIL event after a specified time.

```
<tlrr ver="3.3.0">
  <msids>
    <msid>461011678298</msid>
  </msids>
  <start_time utc_off="+0300">20021003112700</start_time>
  <tlrr_event>
    <ms_action type="MS_AVAIL"/>
  </tlrr_event>
</tlrr>
```

```

</tlrr_event>
  <qop>
    <hor_acc>100</hor_acc>
  </qop>
  <geo_info>
    <CoordinateReferenceSystem>
      <Identifier>
        <code>4326</code>
        <codeSpace>EPSG</codeSpace>
        <edition>6.1</edition>
      </Identifier>
    </CoordinateReferenceSystem>
  </geo_info>
  <pushaddr>
    <url>http://location.application.com</url>
  </pushaddr>
  <loc_type type="CURRENT" />
  <prio type="HIGH" />
</tlrr>

```

Example 4: TLRR for periodic location reports from current time and lasting for a specified period

```

<tlrr ver="3.3.0">
  <msids>
    <msid>461011678298</msid>
  </msids>
  <interval>00003000</interval>
  <duration>00009000</duration>
  <qop>
    <hor_acc>100</hor_acc>
  </qop>
  <geo_info>
    <CoordinateReferenceSystem>
      <Identifier>
        <code>4326</code>
        <codeSpace>EPSG</codeSpace>
        <edition>6.1</edition>
      </Identifier>
    </CoordinateReferenceSystem>
  </geo_info>
  <pushaddr>
    <url>http://location.application.com</url>
  </pushaddr>
  <loc_type type="CURRENT" />
  <prio type="HIGH" />
</tlrr>

```

Example 5: TLRR for a change_area report on the occurrence of a MS_ENTERING event

```

<tlrr ver="3.3.0">
  <msids>
    <msid>461011678298</msid>
  </msids>
  <tlrr_event>
    <change_area type="MS_ENTERING" loc_estimates="TRUE">
      <target_area>
        <name_area>Seoul</name_area>
      </target_area>
    </change_area>
  </tlrr_event>
  <qop>
    <hor_acc>100</hor_acc>
  </qop>
  <geo_info>
    <CoordinateReferenceSystem>
      <Identifier>
        <code>4326</code>
        <codeSpace>EPSG</codeSpace>

```

```

        <edition>6.1</edition>
      </Identifier>
    </CoordinateReferenceSystem>
  </geo_info>
  <pushaddr>
    <url>http://location.application.com</url>
  </pushaddr>
  <loc_type type="CURRENT" />
  <prio type="HIGH" />
</tlrr>

```

Example 6: TLRR for a change_area report on the occurrence of a MS_WITHIN_AREA within a geographical area.

```

<tlrr ver="3.3.0">
  <msids>
    <msid>461011678298</msid>
  </msids>
  <tlrr_event>
    <change_area type="MS_WITHIN_AREA" loc_estimates="FALSE">
      <target_area>
        <shape>
          <CircularArea srsName="www.epsg.org#4326">
            <coord>
              <X>35 35 24.139N</X>
              <Y>139 35 24.754E</Y>
            </coord>
            <radius>15</radius>
          </CircularArea>
        </shape>
      </target_area>
      <no_of_reports>10</no_of_reports>
    </change_area>
  </tlrr_event>
  <pushaddr>
    <url>http://location.application.com</url>
  </pushaddr>
</tlrr>

```

Example 7: TLRR for combined periodic / MS_AVAIL event

```

<tlrr ver="3.3.0">
  <msids>
    <msid>461011678298</msid>
  </msids>
  <interval>00003000</interval>
  <duration>00009000</duration>
  <tlrr_event>
    <ms_action type="MS_AVAIL"/>
  </tlrr_event>
  <qop>
    <hor_acc>100</hor_acc>
  </qop>
  <geo_info>
    <CoordinateReferenceSystem>
      <Identifier>
        <code>4326</code>
        <codeSpace>EPSG</codeSpace>
        <edition>6.1</edition>
      </Identifier>
    </CoordinateReferenceSystem>
  </geo_info>
  <pushaddr>
    <url>http://location.application.com</url>
  </pushaddr>
  <loc_type type="CURRENT" />
  <prio type="HIGH" />
</tlrr>

```

5.2.3.6.2 Triggered Location Reporting Answer DTD

```

<!-- MLP_TLRA -->
<!--
MLP V3.3 Document Type Definition

Copyright Open Mobile Alliance Ltd., 2005
    All rights reserved

MLP is an XML language. Typical usage:
    <?xml version="1.0"?>
    <!DOCTYPE svc_result PUBLIC "-//OMA//DTD {abbrev x.y}//EN"
        "http://www.openmobilealliance.org/DTD/{filename}"
        [<?oma-{ref}-ver supported-versions="{versions}"?>]>
    <svc_result>
        ...
    </svc_result>

Terms and conditions of use are available from the
Open Mobile Alliance Ltd. web site at
http://www.openmobilealliance.org/
-->

<!ENTITY    % extension.param        "">

<!ELEMENT   tlra                      (((req_id, lcs_ref?) | (result, add_info?))
                                         %extension.param;)>

<!ATTLIST   tlra
    ver CDATA                            #FIXED "3.3.0">

```

The (optional) parameter 'lcs_ref' shall be sent to the LCS Client in case the Requesting Location Server receives it from Home Location Server.

Example 1: TLRA if corresponding TLRR was successful

```

<tlra ver="3.3.0">
  <req_id>25293</req_id>
  <lcs_ref>50</lcs_ref>
</tlra>

```

Example 2: TLRA if corresponding TLRR was in error

```

<tlra ver="3.3.0">
  <result resid="4">UNKNOWN SUBSCRIBER</result>
</tlra>

```

5.2.3.6.3 Triggered Location Report DTD

```

<!-- MLP_TLREP -->
<!--
MLP V3.3 Document Type Definition

Copyright Open Mobile Alliance Ltd., 2005
All rights reserved

MLP is an XML language. Typical usage:
  <?xml version="1.0"?>
  <!DOCTYPE svc_result PUBLIC "-//OMA//DTD {abbrev x.y}//EN"
    "http://www.openmobilealliance.org/DTD/{filename}"
    [?oma-{ref}-ver supported-versions="{versions}"]?>
  <svc_result>
    ...
  </svc_result>

Terms and conditions of use are available from the
Open Mobile Alliance Ltd. web site at
http://www.openmobilealliance.org/
-->

<!ENTITY    % extension.param      "">

<!ELEMENT   tlrep                   (req_id, lcs_ref?, trl_pos+, time_remaining?
                                     %extension.param;)>

<!ATTLIST   tlrep
  ver CDATA          #FIXED "3.3.0">

```

The (optional) parameter 'lcs_ref' shall be sent to the LCS Client in case the Requesting Location Server receives it from Home Location Server.

Example 1: Successful positioning of periodic location report

```

<tlrep ver="3.3.0">
  <req_id>25267</req_id>
  <lcs_ref>50</lcs_ref>

  <trl_pos trl_trigger="PERIODIC">
    <msid>461011678298</msid>
    <pd>
      <time utc_off="+0300">20020813010423</time>
      <shape>
        <CircularArea srsName="www.epsg.org#4326">
          <coord>
            <X>35 35 24.139N</X>
            <Y>139 35 24.754E</Y>
          </coord>
          <radius>15</radius>
        </CircularArea>
      </shape>
    </pd>
  </trl_pos>
  <time_remaining>00010000</time_remaining>
</tlrep>

```

Example 2: Cancellation of triggered location report

```

<tlrep ver="3.3.0">
  <req_id>25267</req_id>
  <lcs_ref>50</lcs_ref>

```

```

    <trl_pos trl_trigger="PERIODIC">
      <msid>461011678298</msid>
      <poserr>
        <result resid="114"> CANCELLATION OF TRIGGERED LOCATION REQUEST</result>
        <time utc_off="+0200">20041007110237</time>
      </poserr>
    </trl_pos>
  </tlrep>

```

5.2.3.6.4 Triggered Location Reporting Stop Request DTD

```

<!-- MLP_TLRSR -->
<!--
MLP V3.3 Document Type Definition

Copyright Open Mobile Alliance Ltd., 2008
All rights reserved

MLP is an XML language. Typical usage:
<?xml version="1.0"?>
<!DOCTYPE svc_init PUBLIC "-//OMA//DTD {abbrev x.y}//EN"
    "http://www.openmobilealliance.org/DTD/{filename}"
    [<?oma-{ref}-ver supported-versions="{versions}"?>]>
<svc_init>
    ...
</svc_init>

Terms and conditions of use are available from the
Open Mobile Alliance Ltd. web site at
http://www.openmobilealliance.org/
-->

<!ENTITY    % extension.param      "">

<!ELEMENT   tlrsrc                 ((msids | msid)?, req_id, lcs_ref? %extension.param;)>
<!ATTLIST   tlrsrc
    ver CDATA                #FIXED "3.3.0">

```

The parameter 'msids'/'msid' here means the individual targets whose triggered location reporting will be stopped. If neither msids nor msid is present, the stop request applies to all individual targets.

Example

```

<tlrsrc ver="3.3.0">
  <req_id>25293</req_id>
  <lcs_ref>50</lcs_ref>
</tlrsrc>

```

5.2.3.6.5 Triggered Location Reporting Stop Answer DTD

```

<!-- MLP_TLRSA -->
<!--
MLP V3.3 Document Type Definition

Copyright Open Mobile Alliance Ltd., 2008
    All rights reserved

MLP is an XML language. Typical usage:
  <?xml version="1.0"?>
  <!DOCTYPE svc_result PUBLIC "-//OMA//DTD {abbrev x.y}//EN"
    "http://www.openmobilealliance.org/DTD/{filename}"
    [<?oma-{ref}-ver supported-versions="{versions}"?>]>
  <svc_result>
    ...
  </svc_result>

Terms and conditions of use are available from the
Open Mobile Alliance Ltd. web site at
http://www.openmobilealliance.org/
-->

<!ENTITY    % extension.param      "">

<!ELEMENT   tlrsa                   (((msids | msid)?, req_id) | (result, add_info?))
                                     %extension.param;)>

<!ATTLIST   tlrsa
  ver        CDATA                   #FIXED "3.3.0">

```

The parameter ‘msids’/‘msid’ here means the individual targets whose triggered location reporting has been stopped. If reporting has been stopped for all individual target msids and msid shall not be present.

If the tlrsa included an msid that was invalid the tlrsa shall include the result element.

Example

```

<tlrsa ver="3.3.0">
  <req_id>25293</req_id>
</tlrsa>

```

5.2.3.7 General Error Message Definition

When an LCS client attempts to invoke a service not defined in this specification, the location server SHOULD return a General Error Message. Sending a general error message (GEM) is no proper solution by itself because it can not always be expected that the client will understand this (MLP) response message, since - by sending an invalid request - the client shows that it may not be familiar with the proper set of MLP services. So additional error indications MAY be described in the appropriate transport layer mappings.

```

<!-- MLP_GEM -->
<!--
MLP V3.3 Document Type Definition

Copyright Open Mobile Alliance Ltd., 2002
    All rights reserved

MLP is an XML language. Typical usage:
  <?xml version="1.0"?>

```

```

<!DOCTYPE gem PUBLIC "-//OMA//DTD {abbrev x.y}//EN"
    "http://www.openmobilealliance.org/DTD/{filename}"
    [<?oma-{ref}-ver supported-versions="{versions}"?>]>

<gem>
    ...
</gem>

Terms and conditions of use are available from the
Open Mobile Alliance Ltd. web site at
http://www.openmobilealliance.org/
-->

<!ELEMENT   gem                (result, add_info?)>
<!ATTLIST  gem
    ver CDATA                #FIXED "3.3.0">

```

Example

```

<gem ver="3.3.0">
  <result resid="108">SERVICE NOT SUPPORTED</result>
  <add_info>
    The server does not support a service named 'skir'
  </add_info>
</gem>

```

5.2.3.8 Historic Location Immediate Service

This is a service for requesting reporting of historic locations of one Mobile Subscriber.

When a large number of locations are to be reported, it may take an unacceptably long time before a response can be sent to the LCS Client. The LCS Client can thus indicate it allows the Location Server to send the location responses, either at the time of the response to the request, or individually using one or more connections initiated by the Location Server.

The service consists of the following messages:

- Historic Location Immediate Request
- Historic Location Immediate Answer
- Historic Location Immediate Report

The Historic Location Immediate Service SHALL consist of a Historic Location Immediate Request followed by one Historic Location Immediate Answer and zero, one or more OPTIONAL Historic Location Immediate Reports.

The following message flow as depicted in Figure 8 encapsulates this service:

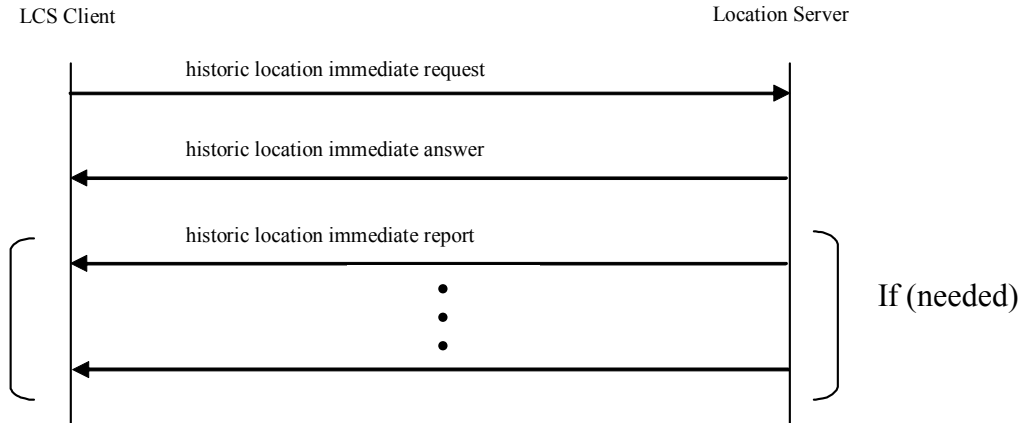

Figure 8: Message Flow for the Historic Location Immediate Service

5.2.3.8.1 Historic Location Immediate Request DTD

```

<!-- MLP_HLIR -->
<!--
MLP V3.3 Document Type Definition

Copyright Open Mobile Alliance Ltd., 2008
All rights reserved

MLP is an XML language. Typical usage:
  <?xml version="1.0"?>
  <!DOCTYPE svc_init PUBLIC "-//OMA//DTD {abbrev x.y}//EN"
    "http://www.openmobilealliance.org/DTD/{filename}"
    [<?oma-{ref}-ver supported-versions="{versions}"?>]>
  <svc_init>
  ...
  </svc_init>

Terms and conditions of use are available from the
Open Mobile Alliance Ltd. web site at
http://www.openmobilealliance.org/
-->

<!ENTITY    % extension.param    "">

<!ELEMENT   hlir                  (msid, trans id?, start time?, stop time?, interval?, qop?,
                                   geo_info?, no_of_reports?, pushaddr?, prio?
                                   %extension.param;)>

<!ATTLIST   hlir
  ver CDATA          #FIXED "3.3.0"
  res_type (SYNC | ASYNC) "SYNC">
    
```

The following rules apply to the use of ‘start_time’, ‘stop_time’ and ‘interval’:

- INTERVAL indicates the minimum time interval between reported positions.
- If STOP_TIME is later than current time, then current time is assumed as stop time.
- If STOP_TIME is earlier than START_TIME then the implementation MUST reject the request with an error indication ‘110’ to the client.

Example

```

<hkir ver="3.3.0">
  <msid>461011678298</msid>
  <start_time utc_off="+0300">20021003112700</start_time>
  <stop_time utc_off="+0300">20021003152700</stop_time>
  <interval>00001000</interval>
  <qop>
    <hor_acc>1000</hor_acc>
  </qop>
  <geo_info>
    <CoordinateReferenceSystem>
      <Identifier>
        <code>4326</code>
        <codeSpace>EPSG</codeSpace>
        <edition>6.1</edition>
      </Identifier>
    </CoordinateReferenceSystem>
  </geo_info>
  <pushaddr>
    <url>http://location.application.com</url>
  </pushaddr>
  <prio type="HIGH" />
</hkir>

```

5.2.3.8.2 Historic Location Immediate Answer DTD

```

<!-- MLP_HLIA -->
<!--
MLP V3.3 Document Type Definition

Copyright Open Mobile Alliance Ltd., 2008
All rights reserved

MLP is an XML language. Typical usage:
<?xml version="1.0"?>
<!DOCTYPE svc_result PUBLIC "-//OMA//DTD {abbrev x.y}//EN"
"http://www.openmobilealliance.org/DTD/{filename}"
[<?oma-{ref}-ver supported-versions="{versions}"?>]>
<svc_result>
...
</svc_result>

Terms and conditions of use are available from the
Open Mobile Alliance Ltd. web site at
http://www.openmobilealliance.org/
-->

<!ENTITY % extension.param "">

<!ELEMENT hlia ((pos+ | req_id | (result, add_info?)) %extension.param;)>
<!ATTLIST hlia
ver CDATA #FIXED "3.3.0">

```

Example: HLIA for async request

```

<tlra ver="3.3.0">
  <req_id>25293</req_id>
</tlra>

```

5.2.3.8.3 Historic Location Immediate Report DTD

```

<!-- MLP_HLIREP -->
<!--
MLP V3.3 Document Type Definition

Copyright Open Mobile Alliance Ltd., 2008
    All rights reserved

MLP is an XML language. Typical usage:
    <?xml version="1.0"?>
    <!DOCTYPE svc_result PUBLIC "-//OMA//DTD {abbrev x.y}//EN"
        "http://www.openmobilealliance.org/DTD/{filename}"
        [<?oma-{ref}-ver supported-versions="{versions}"?>]>
    <svc_result>
        ...
    </svc_result>

Terms and conditions of use are available from the
Open Mobile Alliance Ltd. web site at
http://www.openmobilealliance.org/
-->

<!ENTITY    % extension.param        "">

<!ELEMENT   hlirep                    (req_id, pos+ %extension.param;)>
<!ATTLIST   hlirep
    ver CDATA                            #FIXED "3.3.0">

```

Example 1: Successful historic location report

```

<hlirep ver="3.3.0">
  <req_id>25267</req_id>
  <pos>
    <msid>461011678298</msid>
    <pd>
      <time utc_off="+0300">20020813010423</time>
      <shape>
        <CircularArea srsName="www.epsg.org#4326">
          <coord>
            <X>35 35 24.139N</X>
            <Y>139 35 24.754E</Y>
          </coord>
          <radius>15</radius>
        </CircularArea>
      </shape>
    </pd>
  </pos>
  <pos>
    <msid>461011678298</msid>
    <pd>
      <time utc_off="+0300">20020813011423</time>
      <shape>
        <CircularArea srsName="www.epsg.org#4326">
          <coord>
            <X>35 36 13.482N</X>
            <Y>139 35 75.139E</Y>
          </coord>
          <radius>21</radius>
        </CircularArea>
      </shape>
    </pd>
  </pos>
</hlirep>

```

</pos>
</hlirep>

5.3 Elements and attributes in DTD

5.3.1 add_info

Description:	
A text string containing additional information about a certain result.	
Type:	Element
Format:	Char string
Defined values:	
Default value:	
Example:	<add_info>EVENT</add_info>
Note:	

5.3.2 alt

Description:	
The altitude of the MS in meters in respect of the ellipsoid which is used to be define the coordinates	
Type:	Element
Format:	Char String
Defined values:	[+ -]?[0-9]+
Default value:	
Example:	<alt>1200</alt>
Note:	This element is present if altitude is possible to attain by the used positioning method.

5.3.3 alt_acc

Description:	
Accuracy of requested altitude in meters	
Type:	Element
Format:	Char String
Defined values:	[0-9]+
Default value:	
Example:	<alt_acc>200</alt_acc>
Note:	

5.3.3.1 qos_class

Description:					
defines the degree of adherence by the Location Service to the quality of another quality of service parameter. In the MLP context this refers to the XML “parent” element, i.e alt_acc, hoc_acc, or ll_acc, resp.					
Type:	Attribute				
Format:	Char string				
Defined values:	<table border="1"> <tr> <td>ASSURED</td> <td>defines the most stringent requirement on the accuracy achieved for a location request. If a location estimate obtained does not fulfil the ‘alt_acc’ requirements, then it shall be discarded and an appropriate error cause sent.</td> </tr> <tr> <td>BEST_EFFORT</td> <td>defines the least stringent requirement on the QoS achieved for a location request. If a location estimate obtained does not fulfil the other QoS requirements, it should still be returned but with an appropriate indication that the requested QoS was not met. If no location estimate is obtained, an appropriate error cause is sent.</td> </tr> </table>	ASSURED	defines the most stringent requirement on the accuracy achieved for a location request. If a location estimate obtained does not fulfil the ‘alt_acc’ requirements, then it shall be discarded and an appropriate error cause sent.	BEST_EFFORT	defines the least stringent requirement on the QoS achieved for a location request. If a location estimate obtained does not fulfil the other QoS requirements, it should still be returned but with an appropriate indication that the requested QoS was not met. If no location estimate is obtained, an appropriate error cause is sent.
ASSURED	defines the most stringent requirement on the accuracy achieved for a location request. If a location estimate obtained does not fulfil the ‘alt_acc’ requirements, then it shall be discarded and an appropriate error cause sent.				
BEST_EFFORT	defines the least stringent requirement on the QoS achieved for a location request. If a location estimate obtained does not fulfil the other QoS requirements, it should still be returned but with an appropriate indication that the requested QoS was not met. If no location estimate is obtained, an appropriate error cause is sent.				
Default value:					
Example:	<alt_acc qos_class="BEST_EFFORT">200</alt_acc>				
Note:	For details see 3GPP TS 23.271, v6.8.0, clause 6.5.1				

5.3.4 alt_unc

Description:	
Uncertainty of altitude estimate in meters	
Type:	Element
Format:	Char String
Defined values:	[0-9]+
Default value:	
Example:	<alt_unc>200</alt_unc>
Note:	

5.3.5 angle

Description:	
Specifies the angle (in angularUnit) of rotation of an ellipse measured clockwise from north	
Type:	Element
Format:	Char String
Defined values:	
Default value:	
Example:	<angle>24.30</angle>
Note:	

5.3.6 angularUnit

Description:	
The angularUnit defines the unit for any angular value used in the shape description. For example the startAngle value in the CircularArcArea will be defined by this unit. If this unit is not included in a shape definition the angular unit defined in the CRS SHALL be used.	
Type:	Element
Format:	Char String
Defined values:	Degrees
	Radians
Default value:	Degrees
Example:	<angularUnit>Degrees</angularUnit>
Note:	

5.3.7 Base64Map

Description:	
This element contains the content of a map image.	
Type:	Element
Format:	Char String
Defined values:	
Default value:	
Example:	<Base64Map>iVBORwAANSUhEUg II=</Base64Map>
Note:	The map image data is encoded as “based 64 encoded string”

5.3.8 batch_cond

Description:	
Defines the condition when to execute batch reporting	
Type:	Element
Format:	Char String
Defined values:	1 – 1024 if type is measurements, 1 – 2048 if type is minutes.
Default value:	-
Example:	<batch_cond batch_type="MEASUREMENTS"> 500 </batch_cond>
Note:	

5.3.8.1 batch_type

Description:	
Defines the type of batch condition.	
Type:	Attribute
Format:	Char string
Defined values:	MEASUREMENTS Location reports shall be sent when specified number of

	measurements have executed
MINUTES	Location reports shall be sent when specified number minutes has elapsed.
ENDOFSERVICE	Location report shall be sent when sevice terminates. Any value in element batch_cond is disregarded
Default value:	CURRENT
Example:	<batch_cond batch_type="MEASUREMENTS"> 500 </batch_cond>
Note:	

5.3.9 Box

Description:	
The Box element is used to encode extents	
Type:	Element
Format:	
Defined values:	
Default value:	
Example:	<pre><Box srsName="www.epsg.org#4326" gid="some_thing"> <coord> <X>30 27 45.3N</X> <Y>45 25 52.9E</Y> </coord> <coord> <X>31 27 45.3N</X> <Y>46 25 52.9E</Y> </coord> </Box></pre>
Note:	

5.3.9.1 gid

Description:	
The gid is of XML attribute type ID and is used for references to elements within a single XML document. It allows XML technologies such as XPointer and xref to be used.	
Type:	Attribute
Format:	Char String
Defined values:	
Default value:	
Example:	<Box srsName="www.epsg.org#4326" gid="some_thing">
Note:	This attribute is optional and is on all shape elements

5.3.9.2 srsName

Description:

srsName is a short hand method of defining the CoordinateReferenceSystem. It is a URI datatype that contains the codeSpace and code values, which are defined in the same way as in the CoordinateReferenceSystem.	
Type:	Attribute
Format:	Char String
Defined values:	
Default value:	www.epsg.org/#4326
Example:	<Box srsName="www.epsg.org/#4326">
Note:	This attribute is optional and is on all shape elements. If the srsName is not included the WGS84 CRS SHOULD be assumed.

5.3.10 cc

Description:	
Specifies the country code.	
Type:	Element
Format:	Char String
Defined values:	1-3 digits e.g. 355 for Albania
Default value:	
Example:	<cc>355</cc>
Note:	

5.3.11 cellid

Description:	
Identifies the Cell Identity	
Type:	Element
Format:	Char String
Defined values:	0-65535
Default value:	
Example:	<cellid>546</cellid>
Note:	

5.3.12 change_area

Description:	
Specifies the event that initiated the positioning of the MS	
Type:	Element
Format:	
Defined values:	
Default value:	
Example:	<change_area type="MS_ENTERING"> <target_area>

	<pre> <name_area>Seoul</name_area> </target_area> </change_area> </pre>
Note:	

5.3.12.1 type

Description:	
Specifies the trigger that initiated the positioning of the MS	
Type:	Attribute
Format:	Char string
Defined values:	MS_ENTERING
	MS_LEAVING
	MS_WITHIN_AREA
	MS_OUTSIDE_AREA
Default value:	
Example:	<change_area type="MS_ENTERING">
Note:	

5.3.12.2 loc_estimates

Description:	
Specifies whether location estimates is required or not	
Type:	Attribute
Format:	Char string
Defined values:	TRUE
	FALSE
Default value:	
Example:	<change_area loc_estimates="TRUE">
Note:	

5.3.13 CircularArcArea

Description:	
An arc is defined by a point of origin with one offset angle and one uncertainty angle plus one inner radius and one uncertainty radius.	
Type:	Element
Format:	
Defined values:	
Default value:	
Example:	<pre> <CircularArcArea srsName="www.epsg.org#4326" gid="some_thing"> <coord> <X>30 27 45.3N</X> <Y>45 25 52.9E</Y> </coord> <inRadius>280</inRadius> </pre>

	<pre><outRadius>360</outRadius> <startAngle>5</startAngle> <stopAngle>240</stopAngle> </CircularArcArea></pre>
Note:	

5.3.13.1 gid

See section 5.3.9.1.

5.3.13.2 srsName

See section 5.3.9.2.

5.3.14 CircularArea

Description:	
The set of points on the ellipsoid, which are at a distance from the point of origin less than or equal to “r”.	
Type:	Element
Format:	
Defined values:	
Default value:	
Example:	<pre><CircularArea srsName="www.epsg.org#4326" gid="some_thing"> <coord> <X>30 27 45.3N </X> <Y>45 25 52.9E</Y> </coord> <radius>240</radius> </CircularArea></pre>
Note:	

5.3.14.1 gid

See section 5.3.9.1.

5.3.14.2 srsName

See section 5.3.9.2.

5.3.15 civicloc_element

Description:	
Specifies one element in a civic location. A civic location (civicloc) consists of one or more civicloc_element.	
Type:	Element
Format:	Char string
Defined values:	
Default value:	
Example:	<pre><civicloc_element element_type="COUNTRY">US</civicloc_element></pre>

Note:	
--------------	--

5.3.15.1 element_type

Description:	
Specifies the type of element an civicloc_element contains.	
Type:	Attribute
Format:	Char string
Defined values:	As defined in [RFC 4119] and [RFC 5139]
Default value:	
Example:	<civicloc_element element_type="COUNTRY">US</civicloc_element>

5.3.16 code

Description:	
This is the unique identifier for the Coordinate ReferenceSystem as used by the authority cited in codeSpace	
Type:	Element
Format:	Char String
Defined values:	
Default value:	
Example:	<code>4326</code>
Note:	

5.3.17 codeSpace

Description:	
The codeSpace is the authority, which is responsible for the definition of the coordinate reference systems.	
Type:	Element
Format:	Char String
Defined values:	
Default value:	www.epsg.org/...
Example:	<codeSpace>EPSG</codeSpace>
Note:	

5.3.18 codeword

Description:	
Codeword is an access code defined per MS, used to protect location information of MS against unwanted location request. Only location requests with the correct codeword of a target MS are accepted.	

Type:	Element
Format:	Char String
Defined values:	
Default value:	
Example:	<codeword>0918a7cb</codeword>
Note:	An error SHALL be returned if the number of codewords is not equal to the number of msids in an msid_range.

5.3.19 direction

Description:	
Specifies the direction of movement (in degrees) of a positioned MS	
Type:	Element
Format:	Char String
Defined values:	0-360
Default value:	
Example:	<direction>120</direction>
Note:	This element is present if direction is possible to attain by the used positioning method.

5.3.20 distanceUnit

Description:	
The distanceUnit defines the linear unit for any distance used in the shape description. For example the radius value in the CircularArea will be defined by this unit. If this unit is not included in a shape definition the distance unit defined in the CRS SHOULD be used.	
Type:	Element
Format:	Char String
Defined values:	
Default value:	meter
Example:	<distanceUnit>surveyfoot</distanceUnit>
Note:	values are defined by the CRS authority

5.3.21 duration

Description:			
A string defining the time range of triggered location reporting service.			
Type:	Element		
Format:	Char String		
	The time is expressed as ddhmmss where:		
	<table border="1" style="margin-left: 40px;"> <tr> <td style="padding: 2px;">String</td> <td style="padding: 2px;">Description</td> </tr> </table>	String	Description
String	Description		

	<table border="1"> <tr> <td>dd</td> <td>Day</td> </tr> <tr> <td>hh</td> <td>Hours</td> </tr> <tr> <td>mm</td> <td>Minutes</td> </tr> <tr> <td>ss</td> <td>Seconds</td> </tr> </table>	dd	Day	hh	Hours	mm	Minutes	ss	Seconds
dd	Day								
hh	Hours								
mm	Minutes								
ss	Seconds								
Defined values:									
Default value:									
Example:	<duration>00001000</duration>								
Note:									

5.3.22 edition

Description:	
The edition defines which version of the CRS database defined by the codeSpace authority is used.	
Type:	Element
Format:	Char String
Defined values:	
Default value:	
Example:	<edition>6.0</edition>
Note:	

5.3.23 EllipticalArea

Description:	
A set of points on the ellipsoid, which fall within or on the boundary of an ellipse. This ellipse has a semi-major axis of length r1 oriented at angle A (0 to 180°) measured clockwise from north and a semi-minor axis of length r2.	
Type:	Element
Format:	
Defined values:	
Default value:	
Example:	<pre><EllipticalArea srsName="www.epsg.org#4326" gid="some_thing"> <coord> <X>30 27 45.3N</X> <Y>45 25 52.9E</Y> </coord> <angle>240</angle> <semiMajor>275</semiMajor> <semiMinor>150</semiMinor> <angularUnit>degrees</angularUnit> </EllipticalArea></pre>
Note:	

5.3.23.1 gid

See section 5.3.9.1.

5.3.23.2 srsName

See section 5.3.9.2.

5.3.24 eme_event

Description:	
Specifies the events that initiated the positioning of the MS at an emergency call.	
Type:	Element
Format:	
Defined values:	
Default value:	
Example:	<eme_event eme_trigger="EME_ORG">
Note:	

5.3.24.1 eme_trigger

Description:	
Specifies the trigger that initiated the positioning of the MS at an emergency call.	
Type:	Attribute
Format:	Char string
Defined values:	EME_ORG An emergency service user originated an emergency call EME_REL An emergency service user released an emergency call
Default value:	
Example:	<eme_event eme_trigger="EME_ORG">
Note:	

5.3.25 eme_pos

Description:	
Specifies the position of the MS in an emergency location service response.	
Type:	Element
Format:	
Defined values:	
Default value:	
Example:	<eme_pos pos_method="A-GPS"> <msid>4711</msid> <poserr> <result resid="1">SYSTEM FAILURE</result> <time utc_off="0200">20040617144558</time> </poserr> </eme_pos>
Note:	

5.3.25.1 pos_method

Description:																											
Specifies the positioning method used to obtain the associated location estimate																											
Type:	Attribute																										
Format:	Char string																										
Defined values:	<table border="1"> <tr> <td>CELL</td> <td>Cell coverage based positioning method</td> </tr> <tr> <td>OTDOA</td> <td>Observed Time Difference of Arrival (OTDOA) positioning method</td> </tr> <tr> <td>GPS</td> <td>Global Positioning System (GPS) based positioning method</td> </tr> <tr> <td>A-GPS</td> <td>Assisted GPS based positioning method</td> </tr> <tr> <td>GNSS</td> <td>GNSS (GPS and GANSS) based positioning method</td> </tr> <tr> <td>A-GNSS</td> <td>Assisted GNSS (GPS and GANSS) based positioning method</td> </tr> <tr> <td>E-OTD</td> <td>Enhanced Observed Time Difference (E-OTD) positioning method</td> </tr> <tr> <td>U-TDOA</td> <td>Uplink Time Difference of Arrival (U-TDOA) positioning method</td> </tr> <tr> <td>AFLT</td> <td>Advanced Forward Link Triangulation positioning method</td> </tr> <tr> <td>EFLT</td> <td>Enhanced Forward Link Triangulation positioning method</td> </tr> <tr> <td>E-CID</td> <td>Enhancement Cell ID positioning method</td> </tr> <tr> <td>UNKNOWN</td> <td>Unknown positioning method</td> </tr> <tr> <td>OTHER</td> <td>Any other positioning method</td> </tr> </table>	CELL	Cell coverage based positioning method	OTDOA	Observed Time Difference of Arrival (OTDOA) positioning method	GPS	Global Positioning System (GPS) based positioning method	A-GPS	Assisted GPS based positioning method	GNSS	GNSS (GPS and GANSS) based positioning method	A-GNSS	Assisted GNSS (GPS and GANSS) based positioning method	E-OTD	Enhanced Observed Time Difference (E-OTD) positioning method	U-TDOA	Uplink Time Difference of Arrival (U-TDOA) positioning method	AFLT	Advanced Forward Link Triangulation positioning method	EFLT	Enhanced Forward Link Triangulation positioning method	E-CID	Enhancement Cell ID positioning method	UNKNOWN	Unknown positioning method	OTHER	Any other positioning method
CELL	Cell coverage based positioning method																										
OTDOA	Observed Time Difference of Arrival (OTDOA) positioning method																										
GPS	Global Positioning System (GPS) based positioning method																										
A-GPS	Assisted GPS based positioning method																										
GNSS	GNSS (GPS and GANSS) based positioning method																										
A-GNSS	Assisted GNSS (GPS and GANSS) based positioning method																										
E-OTD	Enhanced Observed Time Difference (E-OTD) positioning method																										
U-TDOA	Uplink Time Difference of Arrival (U-TDOA) positioning method																										
AFLT	Advanced Forward Link Triangulation positioning method																										
EFLT	Enhanced Forward Link Triangulation positioning method																										
E-CID	Enhancement Cell ID positioning method																										
UNKNOWN	Unknown positioning method																										
OTHER	Any other positioning method																										
Default value:																											
Example:	<eme_pos pos_method="A-GPS"> ... </eme_pos>																										
Note:	The list of current values reflects the status quo described in 3GPP TS 23.271, V6.7.0, sect. 4.3 (plus A-GPS) and TIA-801. New values may be added as soon as the need arises.																										

5.3.26 esrd

Description:	
This element specifies Emergency Services Routing Digits (ESRD).	
Type:	Element
Format:	Char string
Defined values:	
Default value:	
Example:	<esrd>761287612582</esrd>
Note:	

5.3.26.1 type

Description:			
Defines the origin of the ESRD			
Type:	Attribute		
Format:	Char string		
Defined values:	<table border="1"> <tr> <td>NA</td> <td>Indicates that the ESRD is defined as the North American ESRD (NA-ESRD). NA-ESRD is a telephone number in the North American Numbering Plan that can be used to identify a North American emergency services</td> </tr> </table>	NA	Indicates that the ESRD is defined as the North American ESRD (NA-ESRD). NA-ESRD is a telephone number in the North American Numbering Plan that can be used to identify a North American emergency services
NA	Indicates that the ESRD is defined as the North American ESRD (NA-ESRD). NA-ESRD is a telephone number in the North American Numbering Plan that can be used to identify a North American emergency services		

	provider and it's associated Location Services client. The NA-ESRD also identifies the base station, cell site or sector from which a North American emergency call originates
Default value:	NA
Example:	<code><esrd type="NA">12345678</ersd></code>
Note:	Currently only NA is specified. It is expected that other origins will be specified in the future

5.3.27 esrk

Description:	
This element specifies the Services Routing Key (ESRK).	
Type:	Element
Format:	Char string
Defined values:	-
Default value:	-
Example:	<code><esrk>928273633343</esrk></code>
Note:	-

5.3.27.1 type

Description:	
Defines the origin of the ESRK	
Type:	Attribute
Format:	Char string
Defined values:	NA Indicates that the ESRK is defined as the North American ESRK (NA-ESRK).NA-ESRK is a telephone number in the North American Numbering Plan that is assigned to an emergency services call for the duration of the call. The NA-ESRK is used to identify (e.g. route to) both the emergency services provider and the switch currently serving the emergency caller. During the lifetime of an emergency services call, the NA-ESRK also identifies the calling subscriber.
Default value:	NA
Example:	<code><esrk type="NA">12345678</ersk></code>
Note:	Currently only NA is specified. It is expected that other origins will be specified in the future

5.3.28 Height

Description:	
This element specifies the requested height of map image	
Type:	Element
Format:	Char String
Defined values:	[0-9]+
Default value:	0
Example:	<code><Height>600</Height></code>
Note:	The default type of map height is defined as pixel.

5.3.29 Hemisphere

Description:	
first and the mandatory component in the representation of a location in UTM coordinate system	
Type:	Element
Format:	Char string
Defined values:	NORTH It specifies the zone in the north of the equator SOUTH It specified the zone in the south of the equator
Default value:	
Example:	<Hemisphere>NORTH</Hemisphere>
Note:	Stands for Hemisphere of a position in UTM Coordinate System.

5.3.30 hor_acc

Description:	
Horizontal accuracy in meters	
Type:	Element
Format:	Char String
Defined values:	[0-9]+
Default value:	
Example:	<hor_acc>200</hor_acc>
Note:	

5.3.30.1 qos_class

See section 5.3.3.1

5.3.31 id

Description:	
A string defining the name of a registered user performing a location request. In an answer the string represents the name of a location server.	
Type:	Element
Format:	Char string
Defined values:	
Default value:	
Example:	<id>TheTruckCompany</id>
Note:	This element is implementation specific.

5.3.32 imsi

Description:	
The International Mobile Subscriber Identity number as specified in 3GPP TS 23.003 and ITU-T E212 Recommendation.	
Type:	Element
Format:	Char String
Defined values:	-
Default value:	-
Example:	<imsi>123456789012345</imsi>
Note:	-

5.3.33 inRadius

Description:	
The inner radius is the geodesic distance (in distanceUnit) between the center of the circle (that the arc is a part of) and the arc closest to the center	
Type:	Element
Format:	Char String
Defined values:	[0-9]+
Default value:	
Example:	<inRadius>100</inRadius>
Note:	If the inner radius is 0 (zero) the area described represents a sector of a circle.

5.3.34 interval

Description:		
Specifies the interval between two responses in case of a TLRR indicating timer controlled, periodic responses or minimum interval between reported positions in case of HLIR.		
Type:	Element	
Format:	Char string	
	The interval is expressed as ddhhmmss where:	
	String	Description
	dd	Number of days between responses
	hh	Number of hours between responses
	mm	Number of minutes between responses
ss	Number of seconds between responses	
Defined values:		
Default value:		
Example:	<interval>00010000</interval>	
Note:		

5.3.35 ip_address

Description:	
This element represents an identifier of the IP address used by a terminal.	
Type:	Element
Format:	Char string
Defined values:	As per [RFC796] IPV4 or [RFC3513] IPV6
Default value:	
Example:	<ip_address>147.211.234.10</ip_address>
Note:	

5.3.36 lac

Description:	
Identifies the Location Area Code	
Type:	Element
Format:	Char String
Defined values:	1-65535
Default value:	
Example:	<lac>234</lac>
Note:	Location Area Code (LAC) is a fixed length code (of 2 octets) identifying a location area within a GSM PLMN. This part of the location area identification can be coded using a full hexadecimal representation, except for the following reserved hexadecimal values: 0000, and FFFE

5.3.37 lcs_ref

Description:	
The LDR reference number received from Home Location Server. For more information see [23.271]	
Type:	Element
Format:	Char String
Defined values:	Two decimal digits, 00-64
Default value:	-
Example:	<lcs_ref>50</lcs_ref>
Note:	Lcs_ref SHALL be sent in the triggered location reporting request with change of area event or MS_AVAIL event and combined triggered location reporting request with periodic event / MS_AVAIL event request case. The LDR reference number is received as one octet and shall be encoded to the decimal numbers 00 to 64.

5.3.38 lev_conf

Description:	
This parameter indicates the probability in percent that the MS is located in the position area that is returned.	
Type:	Element

Format:	Char String
Defined values:	0-100
Default value:	
Example:	<lev_conf>80</lev_conf>
Note:	

5.3.39 LinearRing

Description:	
A linear ring is a closed, simple piece-wise linear path which is defined by a list of coordinates that are assumed to be connected by straight-line segments.	
Type:	Element
Format:	
Defined values:	
Default value:	
Example:	<pre><LinearRing srsName="www.epsg.org#4326" gid="some_thing"> <coord> <X>30 27 45.3N</X> <Y>45 25 52.9E</Y> </coord> <coord> <X>40 27 45.3N</X> <Y>48 25 52.9E</Y> </coord> <coord> <X>33 27 45.3N</X> <Y>46 25 52.9E</Y> </coord> <coord> <X>30 27 45.3N</X> <Y>45 25 52.9E</Y> </coord> </LinearRing></pre>
Note:	

5.3.39.1 gid

See section 5.3.9.1.

5.3.39.2 srsName

See section 5.3.9.2.

5.3.40 LineString

Description:

A line string is a piece-wise linear path which is defined by a list of coordinates that are assumed to be connected by straight-line segments.	
Type:	Element
Format:	
Defined values:	
Default value:	
Example:	<pre><LineString srsName="www.epsg.org#4326" gid="some_thing"> <coord> <X>30 27 45.3N</X> <Y>48 25 52.9E</Y> </coord> <coord> <X>40 27 45.3N</X> <Y>48 25 52.9E</Y> </coord> <coord> <X>33 27 45.3N</X> <Y>48 25 52.9E</Y> </coord> </LineString></pre>
Note:	

5.3.40.1 gid

See section 5.3.9.1.

5.3.40.2 srsName

See section 5.3.9.2.

5.3.41 ll_acc

Description:	
Longitude and latitude accuracy in seconds.	
Type:	Element
Format:	Char String
Defined values:	
Default value:	
Example:	<ll_acc>7.5</ll_acc>
Note:	

5.3.41.1 qos_class

see section 5.3.3.1

5.3.42 lmsi

Description:	
A local identity allocated by the VLR to a given subscriber for internal management of data in the VLR as defined in [29.002]	
Type:	Element
Format:	Char String
Defined values:	
Default value:	
Example:	<lmsi>234</lmsi>
Note:	The LMSI consists of 4 octets

5.3.43 loc_type

Description:	
Defines the type of location requested.	
Type:	Element
Format:	Void
Defined values:	
Default value:	
Example:	<loc_type type="INITIAL" />
Note:	

5.3.43.1 type

Description:									
Defines the type of location requested									
Type:	Attribute								
Format:	Char string								
Defined values:	<table border="1"> <tr> <td>CURRENT</td> <td>After a location attempt has successfully delivered a location estimate and its associated time stamp, the location estimate and time stamp is known as the current location at that point in time.</td> </tr> <tr> <td>LAST</td> <td>The current location estimate and its associated time stamp is generally stored in the network and is known as the last known location until replaced by a later location estimate and a new time stamp. The last known location may be distinct from the initial location, i.e., more recent.</td> </tr> <tr> <td>LAST_OR_CURRENT</td> <td>If the last known location is stored in the network and if this location satisfies the Quality of Service requested by the location-based application the last known location is returned, otherwise the current location is returned.</td> </tr> <tr> <td>CURRENT_OR_LAST</td> <td>If a location attempt has successfully delivered a current location, it is returned. Otherwise if the last known location stored in the network satisfies the requested Quality of service the last known</td> </tr> </table>	CURRENT	After a location attempt has successfully delivered a location estimate and its associated time stamp, the location estimate and time stamp is known as the current location at that point in time.	LAST	The current location estimate and its associated time stamp is generally stored in the network and is known as the last known location until replaced by a later location estimate and a new time stamp. The last known location may be distinct from the initial location, i.e., more recent.	LAST_OR_CURRENT	If the last known location is stored in the network and if this location satisfies the Quality of Service requested by the location-based application the last known location is returned, otherwise the current location is returned.	CURRENT_OR_LAST	If a location attempt has successfully delivered a current location, it is returned. Otherwise if the last known location stored in the network satisfies the requested Quality of service the last known
CURRENT	After a location attempt has successfully delivered a location estimate and its associated time stamp, the location estimate and time stamp is known as the current location at that point in time.								
LAST	The current location estimate and its associated time stamp is generally stored in the network and is known as the last known location until replaced by a later location estimate and a new time stamp. The last known location may be distinct from the initial location, i.e., more recent.								
LAST_OR_CURRENT	If the last known location is stored in the network and if this location satisfies the Quality of Service requested by the location-based application the last known location is returned, otherwise the current location is returned.								
CURRENT_OR_LAST	If a location attempt has successfully delivered a current location, it is returned. Otherwise if the last known location stored in the network satisfies the requested Quality of service the last known								

	location is returned.
	INITIAL In an originating emergency call, the location estimate and the associated time stamp at the commencement of the call set-up is known as the initial location.
	CURRENT_AND_INTERMEDIATE In addition to delivery of a final current location estimate (or error indication) the location server shall, if applicable, deliver one or more intermediate location estimates not fulfilling the QoP.
Default value:	CURRENT
Example:	<code><loc_type type="INITIAL" /></code>
Note:	

5.3.43.2 per_type

Description:	
Defines the type of periodic location requested	
Type:	Attribute
Format:	Char string
Defined values:	REALTIME Location Reports shall be sent to MLS Client at the requested interval independent if current position estimate is available or not.
	QUASIREALTIME Location Reports shall be sent to MLS Client at the requested interval if current position estimates are available. If current position estimate is unavailable due to lack of communication with the target, no report shall be sent. If position estimates later becomes available they shall immediately be sent to MLS Client
	BATCH Location Reports shall be sent to MLS Client when batch condition is fulfilled or when service is terminated.
Default value:	REALTIME
Example:	<code><loc_type per_type="BATCH" /></code>
Note:	

5.3.44 MapRequest

Description: Specifies the format of requested map information.	
The Map Request	
Type:	Element
Format:	Char String
Defined values:	
Default value:	
Example:	<code><MapRequest MapdataType="MAP" MimeType="PNG"> <Width>800</Width> <Height>600</Height> <Zoom ZoomType="KILOMETER">1</Zoom> </MapRequest></code>
Note:	The map image is rendered by location server based on the MapRequest settings.

5.3.44.1 MapdataType

Description:	
This element specifies The the content type of Map data Request	
Type:	Attribute
Format:	Char String
Defined values:	
Default value:	MAP specifies the map image request.
	URL specifies the request for the url address of map image .
Example:	<MapRequest MapdataType="MAP">

5.3.44.2 MimeType

Description:									
This element specifies the mime type of map image									
Type:	Element								
Format:	Char String								
Defined values:	<table border="1"> <tr> <td>GIF</td> <td>it specifies the image format designed by Generation IV International Forum</td> </tr> <tr> <td>JPEG</td> <td>it specifies the image format designed by Joint Photographic Experts Group</td> </tr> <tr> <td>PNG</td> <td>it specifies the image format designed by Portable Network Graphics</td> </tr> <tr> <td>TIFF</td> <td>it specifys Tagged Image File Format</td> </tr> </table>	GIF	it specifies the image format designed by Generation IV International Forum	JPEG	it specifies the image format designed by Joint Photographic Experts Group	PNG	it specifies the image format designed by Portable Network Graphics	TIFF	it specifys Tagged Image File Format
GIF	it specifies the image format designed by Generation IV International Forum								
JPEG	it specifies the image format designed by Joint Photographic Experts Group								
PNG	it specifies the image format designed by Portable Network Graphics								
TIFF	it specifys Tagged Image File Format								
Default value:	PNG								
Example:	<MapRequest MimeType="PNG">								
Note:									

5.3.45 max_loc_age

Description:	
This states the maximum allowable age in seconds of a location sent as a response to a location request. This location information may have been cached somewhere in the system from a previous location update.	
Type:	Element
Format:	Char string
Defined values:	Maximum number of seconds (must be >= 0)
Default value:	Implementation specific.
Example:	<max_loc_age>3600</max_loc_age>
Note:	

5.3.46 mcc

Description:	
Specifies the mobile country code (MCC).	
Type:	Element
Format:	Char String
Defined values:	3 digits, e.g. 234 for the UK
Default value:	
Example:	<mcc>234</mcc>
Note:	

5.3.47 mnc

Description:	
Specifies the mobile network code.	
Type:	Element
Format:	Char string
Defined values:	2 - 3 digits e.g. 15 for Vodafone
Default value:	
Example:	<mnc>215</mnc>
Note:	

5.3.48 ms_action

Description:	
Specifies the trigger that initiated the positioning of the MS.	
Type:	Element
Format:	Void
Defined values:	
Default value:	
Example:	<ms_action type="MS_AVAIL" />
Note:	

5.3.48.1 type

Description:	
Specifies the trigger that initiated the positioning of the MS.	

Type:	Attribute
Format:	Char string
Defined values:	MS_AVAIL The positioning is triggered by the MS available notification when the MS regains radio connection with the network if the connection was previously lost. For more information refer to 3GPP [23.271].
Default value:	
Example:	<ms_action type="MS_AVAIL" />
Note:	

5.3.49 msid

Description:	
This element represents an identifier of a mobile subscriber	
Type:	Element
Format:	Char string
Defined values:	
Default value:	
Example:	<msid>460703057640</msid>
Note:	When appropriate the MSID type format SHOULD conform to the full standardised international representation of the MSID type, without any additional unspecified characters or spaces. As an example the GSM/3GPP identifiers SHOULD conform to 3GPP [23.003]

5.3.49.1 type

Description:																							
Type of identifier for the mobile subscriber																							
Type:	Attribute																						
Format:	Char string																						
Defined values:	<table border="1"> <tr> <td>MSISDN</td> <td>Mobile Station International ISDN Number [23.003]</td> </tr> <tr> <td>IMSI</td> <td>International Mobile Subscriber Identity [23.003], [J-STD-036]</td> </tr> <tr> <td>IMEI</td> <td>International Mobile station Equipment Identity [23.003]</td> </tr> <tr> <td>MIN</td> <td>Mobile Identification Number [IS-41D]</td> </tr> <tr> <td>MDN</td> <td>Mobile Directory Number [IS-41D]</td> </tr> <tr> <td>EME_MSID</td> <td>Emergency MSID</td> </tr> <tr> <td>ASID</td> <td>Anonymous Subscriber Identity</td> </tr> <tr> <td>IPV4</td> <td>Mobile station IP address (Version 4) [RFC796]</td> </tr> <tr> <td>OPE_ID</td> <td>Operator specific Identity</td> </tr> <tr> <td>IPV6</td> <td>Mobile station IP address (Version 6) [RFC3513]</td> </tr> <tr> <td>SESSID</td> <td>Session identifier relating to the user, which MAY be anonymous</td> </tr> </table>	MSISDN	Mobile Station International ISDN Number [23.003]	IMSI	International Mobile Subscriber Identity [23.003], [J-STD-036]	IMEI	International Mobile station Equipment Identity [23.003]	MIN	Mobile Identification Number [IS-41D]	MDN	Mobile Directory Number [IS-41D]	EME_MSID	Emergency MSID	ASID	Anonymous Subscriber Identity	IPV4	Mobile station IP address (Version 4) [RFC796]	OPE_ID	Operator specific Identity	IPV6	Mobile station IP address (Version 6) [RFC3513]	SESSID	Session identifier relating to the user, which MAY be anonymous
MSISDN	Mobile Station International ISDN Number [23.003]																						
IMSI	International Mobile Subscriber Identity [23.003], [J-STD-036]																						
IMEI	International Mobile station Equipment Identity [23.003]																						
MIN	Mobile Identification Number [IS-41D]																						
MDN	Mobile Directory Number [IS-41D]																						
EME_MSID	Emergency MSID																						
ASID	Anonymous Subscriber Identity																						
IPV4	Mobile station IP address (Version 4) [RFC796]																						
OPE_ID	Operator specific Identity																						
IPV6	Mobile station IP address (Version 6) [RFC3513]																						
SESSID	Session identifier relating to the user, which MAY be anonymous																						
	SIP_URI IMS Public User Identity (Session Initiation Protocol Uniform Resource Identifier) [RFC 3261]																						
	TEL_URL Telephone Uniform Resource Locator [RFC 2806]																						
	NAI Network Access Identifier [RFC 4282]																						
Default value:	MSISDN																						

Example:	<msid type="IMSI">
Note:	

5.3.49.2 enc

Description:	
Type of encoding of MSID identifier for the mobile subscriber	
Type:	Attribute
Format:	Char string
Defined values:	ASC Normal textual format
	CRP Encrypted format: Can be used to protect target privacy by only proving the LCS client with an Encrypted MSID
Default value:	ASC
Example:	<msid type="IMSI" enc="ASC">
Note:	

5.3.50 MultiLineString

Description:	
A collection of line strings.	
Type:	Element
Format:	
Defined values:	
Default value:	
Example:	<pre><MultiLineString srsName="www.epsg.org#4326" gid="some_thing"> <LineString> ... </LineString> </MultiLineString></pre>
Note:	

5.3.50.1 gid

See section 5.3.9.1.

5.3.50.2 srsName

see section 5.3.9.2.

5.3.51 MultiPoint

Description:

A collection of points.	
Type:	Element
Format:	
Defined values:	
Default value:	
Example:	<pre><MultiPoint srsName="www.epsg.org#4326" gid="some_thing"> <Point> ... </Point> </MultiPoint></pre>
Note:	

5.3.51.1 gid

See section 5.3.9.1.

5.3.51.2 srsName

See section 5.3.9.2.

5.3.52 MultiPolygon

Description:	
A collection of polygons.	
Type:	Element
Format:	
Defined values:	-
Default value:	-
Example:	<pre><MultiPolygon srsName="www.epsg.org#4326" gid="some_thing"> <Polygon> ... </Polygon> </MultiPolygon></pre>
Note:	

5.3.52.1 gid

See section 5.3.9.1.

5.3.52.2 srsName

See section 5.3.9.2.

5.3.53 name_area

Description:	
Specify the geopolitical name of area in change_area event.	
Type:	Element

Format:	Char string
Defined values:	
Default value:	
Example:	<name_area>Seoul</name_area>
Note:	

5.3.54 ndc

Description:	
Specifies the national destination code.	
Type:	Element
Format:	Char string
Defined values:	Variable length depending upon the requirements of the destination country.
Default value:	
Example:	<ndc>215</ndc>
Note:	

5.3.55 nmr

Description:	
Network specific measurement result for the target MS.	
Type:	Element
Format:	Char string
Defined values:	For examples see relevant standards documents.
Default value:	
Example:	
Note:	Measurement Results are encoded as 34 hexadecimal characters representing, 17 binary octets, in accordance with the Measurement Result information element described in [04.18].

5.3.56 no_of_reports

Description:	
Specify the maximum number of reports for a TLRR or HLIR request.	
Type:	Element
Format:	Char String
Defined values:	[1-9]+
Default value:	1
Example:	<no_of_reports>5</no_of_reports>
Note:	

5.3.57 outRadius

Description:	
The radius of a circle furthest away from the position in a CircularArcArea. The value is in the distanceUnit	
Type:	Element
Format:	Char String
Defined values:	[0-9]+
Default value:	
Example:	<outRadius>120</outRadius>
Note:	

5.3.58 plmn

Description:	
A unique identity of Public Land Mobile Network as defined in [23.003].	
Type:	Element
Format:	Char String
Defined values:	
Default value:	
Example:	<pre><plmn> <mcc>234</mcc> <mnc>215</mnc> </plmn></pre>
Note:	

5.3.59 Point

Description:	
A geographic coordinate	
Type:	Element
Format:	
Defined values:	
Default value:	
Example:	<pre><Point srsName="www.epsg.org#4326" gid="some_thing"> <coord> <X>30 27 45.3N</X> <Y>45 25 52.9E</Y> </coord> </Point></pre>
Note:	

5.3.59.1 gid

See section 5.3.9.1.

5.3.59.2 srsName

See section 5.3.9.2.

5.3.60 Polygon

Description:	
A connected surface. Any pair of points in the polygon can be connected to one another by a path. The boundary of the Polygon is a set of LinearRings. We distinguish the outer (exterior) boundary and the inner (interior) boundaries; the LinearRings of the interior boundary cannot cross one another and cannot be contained within one another.	
Type:	Element
Format:	
Defined values:	
Default value:	
Example:	<pre><Polygon srsName="www.epsg.org#4326" gid="some_thing"> <outerBoundaryIs> ... </outerBoundaryIs > </Polygon></pre>
Note:	

5.3.60.1 gid

See section 5.3.9.1.

5.3.60.2 srsName

See section 5.3.9.2.

5.3.61 pos

Description:	
Specifies the position of the MS in an immediate location service response.	
Type:	Element
Format:	
Defined values:	
Default value:	
Example:	<pre><pos> <msid>4711</msid> <poserr> <result resid="1">SYSTEM FAILURE</result> <time utc_off="0200">20040617143232</time> </poserr> </pos></pre>
Note:	

5.3.61.1 pos_method

See section 5.3.25.1

5.3.61.2 result_type

Description:	
Defines the type of location result reported	
Type:	Attribute
Format:	Char string
Defined values:	INTERMEDIATE The location estimate in the pos element is not deemed to fulfil the QoP and will be followed by an final location estimate.
	FINAL The pos element contains the final location estimate or poserror.
Default value:	FINAL
Example:	<result_type="INTERMEDIATE" />
Note:	

5.3.62 prio

Description:	
Defines the priority of a location request	
Type:	Element
Format:	Void
Defined values:	
Default value:	
Example:	<prio />
Note:	

5.3.62.1 type

Description:	
Defines the priority of a location request	
Type:	Attribute
Format:	Char string
Defined values:	NORMAL The request is handled with normal priority
	HIGH The request is handled with high priority
Default value:	NORMAL
Example:	<prio type="HIGH" />
Note:	

5.3.63 pwd

Description:

The password for the registered user performing a location request. In this answer the string represents the password for a location server.	
Type:	Element
Format:	Char string
Defined values:	
Default value:	
Example:	<pwd>the5pwd</pwd>
Note:	

5.3.64 qos_not_met

Description:	
Indication that the requested QoS was not met, if needed.	
Type:	Element
Format:	Void
Defined values:	
Default value:	
Example:	
Note:	Only applicable if the request was for best effort class, i.e. a location estimate is returned (rather than an error) although the requested QoS requirement could not be fulfilled.

5.3.65 radius

Description:	
The uncertainty radius is the radius (in distanceUnit) of the uncertainty; this is the geodesic distance between the arc and the position point.	
Type:	Element
Format:	Char String
Defined values:	[0-9]+
Default value:	
Example:	<radius>850</radius>
Note:	

5.3.66 req_id

Description:	
Unique identification of a request	
Type:	Element
Format:	Char string
Defined values:	
Default value:	
Example:	<req_id>435.23.01</req_id>
Note:	

5.3.67 requested_positiondata

Description:							
Defines the types of location info that is requested in location responses.							
Type:	Attribute						
Format:	Char string						
Defined values:	<table border="1"> <tr> <td>SHAPE</td> <td>The returned positiondata should include a shape element</td> </tr> <tr> <td>CIVICLOC</td> <td>The returned positiondata should include a civicloc element</td> </tr> <tr> <td>SHAPE_AND_CIVICLOC</td> <td>The returned positiondata should include a shape and a civicloc element</td> </tr> </table>	SHAPE	The returned positiondata should include a shape element	CIVICLOC	The returned positiondata should include a civicloc element	SHAPE_AND_CIVICLOC	The returned positiondata should include a shape and a civicloc element
SHAPE	The returned positiondata should include a shape element						
CIVICLOC	The returned positiondata should include a civicloc element						
SHAPE_AND_CIVICLOC	The returned positiondata should include a shape and a civicloc element						
Default value:	SHAPE						
Example:	<geoinfo shape_requested="SHAPE"></geoinfo>						
Note:							

5.3.68 requestmode

Description:	
Defines the type of the service that has been requested by the ASP.	
Type:	Element
Format:	Void
Defined values:	
Default value:	
Example:	<requestmode type="ACTIVE"/>
Note:	If the request mode is 'ACTIVE', the session element is included in msids of location request. The session element can be used as a credential by the Location Server or underlying network to verify that the request is actually 'ACTIVE'. One example of this can be that the network verifies the number the target has dialed that is presented by the MLS Client in the session element. The session element is either the number called by the UE for a call related location request or the APN on which the UE established the session for a session related location request according to [23.271]. The LCS Client determines whether the LCS service request is call/session related or not.

5.3.69 requestor

Description:	
This element describes the originating entity which has requested the location of the target MS from the MLS client.	
Type:	Element
Format:	Compound
Defined values:	
Default value:	n/a
Example:	<pre><requestor> <id>08154711</id> </requestor></pre>
Note:	

5.3.69.1 type

Description:																					
This attribute represents the type of the requestor identifier																					
Type:	Attribute																				
Format:	Char String																				
Defined values:	<table border="1"> <tr> <td>NAME</td> <td>Logical name</td> </tr> <tr> <td>MSISDN</td> <td>MSISDN</td> </tr> <tr> <td>IMSI</td> <td>IMSI</td> </tr> <tr> <td>E-MAIL</td> <td>E-mail address</td> </tr> <tr> <td>URL</td> <td>URL</td> </tr> <tr> <td>SIPURL</td> <td>SIP URL</td> </tr> <tr> <td>IMS</td> <td>IP multimedia subsystem public identity</td> </tr> <tr> <td>MDN</td> <td>MDN</td> </tr> <tr> <td>ASID</td> <td>ASID</td> </tr> <tr> <td>ASPID</td> <td>Logical name of an Application Service Provider that is associated with the Client or Subclient .</td> </tr> </table>	NAME	Logical name	MSISDN	MSISDN	IMSI	IMSI	E-MAIL	E-mail address	URL	URL	SIPURL	SIP URL	IMS	IP multimedia subsystem public identity	MDN	MDN	ASID	ASID	ASPID	Logical name of an Application Service Provider that is associated with the Client or Subclient .
NAME	Logical name																				
MSISDN	MSISDN																				
IMSI	IMSI																				
E-MAIL	E-mail address																				
URL	URL																				
SIPURL	SIP URL																				
IMS	IP multimedia subsystem public identity																				
MDN	MDN																				
ASID	ASID																				
ASPID	Logical name of an Application Service Provider that is associated with the Client or Subclient .																				
Default value:	MSISDN																				
Example:	<pre><requestor type="SIPURL"> <id>sip:+1-212-555-1212:1234@gateway.com;user=phone</id> <serviceid>4711</serviceid> </requestor></pre>																				
Note:	References to the definition and the format of each of these types ,except ASPID, can be found in [23.271],																				

5.3.70 resp_req

Description:	
This attribute represents the response time required.	
Type:	Element
Format:	Void
Defined values:	
Default value:	
Example:	<resp_req type="NO_DELAY" />
Note:	

5.3.70.1 type

Description:	
This attribute represents the response time required	
Type:	Attribute
Format:	Char String
Defined values:	NO_DELAY No delay: The server SHOULD immediately return any location estimate that it currently has.
	LOW_DELAY Low delay: Fulfilment of the response time requirement takes precedence over fulfilment of the accuracy requirement.
	DELAY_TOL Delay tolerant: Fulfilment of the accuracy requirement takes precedence over fulfilment of the response time requirement.
Default value:	DELAY_TOL
Example:	<resp_req />
Note:	The interpretation of these parameters is defined in 3GPP [22.071] and [29.002]. When this parameter is used with the resp_timer, the resp_timer will take precedence over this parameter.

5.3.71 resp_timer

Description:	
Defines a timer for the response time within which the current location SHOULD be obtained and returned to the LCS Client.	
Type:	Element
Format:	Char String
Defined values:	Maximum number of seconds (must be >= 0)
Default value:	The default value is defined in the location server and will be implementation specific
Example:	<resp_timer>45</resp_timer>
Note:	When this parameter is used with the resp_req, this parameter will take precedence over the resp_req.

5.3.72 result

Description:

A text string indicating the result of the request or an individual positioning	
Type:	Element
Format:	Char string
Defined values:	See section 5.4 "Result codes"
Default value:	
Example:	<result resid="0">OK</result>
Note:	

5.3.72.1 resid

Description:	
This attribute represents a numeric representation of a result message	
Type:	Attribute
Format:	Char String
Defined values:	[0-9]+
Default value:	
Example:	<result resid="0">OK</result>
Note:	See section 5.4.

5.3.73 semiMajor

Description:	
Specifies the length (in distanceUnit) of the semi-major axis of an ellipse.	
Type:	Element
Format:	Char String
Defined values:	[0-9]+
Default value:	
Example:	<semiMajor>560</semiMajor>
Note:	

5.3.74 semiMinor

Description:	
Specifies the length (in distanceUnit) of the semi-minor axis of an ellipse.	
Type:	Element
Format:	Char String
Defined values:	[0-9]+
Default value:	
Example:	<semiMinor>560</semiMinor>
Note:	

5.3.75 Service attributes

5.3.75.1 res_type

Description:		
Defines a response type at the Standard Location and Emergency and Historic Location Immediate Service. This attribute applies to the Standard Immediate Location Request message and the Emergency Immediate Location Request message and Historic Location Immediate Request.		
Type:	Attribute	
Format:	Char string	
Defined values:	SYNC	A LCS Client requests to receive the location response in one response
	ASYNCR	A LCS Client allows to receive the location responses in pieces using several consecutive connections initiated by the location Server
Default value:	SYNC	
Example:	<code><slir ver="3.3.0" res_type="SYNC"></code>	
Note:		

5.3.75.2 ver

Description:	
Defines the version of the location protocol. This attribute is valid for ALL messages	
Type:	Element
Format:	Char string
Defined values:	<code>[1-9]+[0-9]*.[0-9]+.[0-9]+</code>
Default value:	
Example:	<code><slia ver="3.3.0"></code>
Note:	

5.3.76 serviceid

Description:	
Specifies an id that is used by an entity to identify the service or application that is accessing the network.	
Type:	Element
Format:	Char String
Defined values:	-
Default value:	-
Example:	<code><serviceid>0005</serviceid></code>
Note:	

5.3.76.1 type

Description:	
Defines the type of the service that has been requested by the ASP	
Type:	Attribute
Format:	Char string
Defined values:	PASSIVE The service is one that is not directly initiated by the user.
	ACTIVE The service is one that the user is initiating personally.
Default value:	PASSIVE
Example:	<code><requestmode type="ACTIVE" /></code>
Note:	The default value is set to PASSIVE, as this is likely to be the one that is most restrictively defined by the user.

5.3.77 session

Description:	
This element SHOULD be presented in the location request when the LCS Client has an active session with the User Equipment, this will be either the number called by the UE or the APN on which the UE established the session.	
Type:	Element
Format:	Char String
Defined values:	-
Default value:	-
Example:	<code><session type="DIAL">447073100177</session></code>
Note:	According to [23.271], for a call related location request, the LCS Client includes the LCS Client's called party number, as dialled by the target mobile user, in the LCS service request. For a session related location request, the LCS Client includes the APN-NI of the LCS Client, as used by the target UE, in the LCS service request. It means that it is up to the LCS Client whether the LCS service request is call/session related or not.

5.3.77.1 type

Description:	
Defines the type of session that is established between the User Equipment and LCS Client	
Type:	Attribute
Format:	Char string
Defined values:	APN Access Point Name.
	DIAL The number dialed by the user to access the LCS client.
Default value:	
Example:	<code><session type="DIAL">447073100177</session></code>
Note:	

5.3.78 sessionid

Description:	
Specifies an id that can be used by an entity to support privacy mechanisms, a sessionid may replace the need to use an ID and PWD to use the location services. In a request when a client and sessionid are present together the session id may indicate the number dialed by the end user to access the service or the APN through which the original session was established that initiated the service. The response indicates the sessionid that the entity can use on subsequent requests. In this casethe sessionid could be a generated alphanumeric string and can be time-limited.	
Type:	Element
Format:	Char String
Defined values:	
Default value:	
Example:	<sessionid>34eg6.876.76h4</sessionid>
Note:	

5.3.79 speed

Description:	
The speed of the MS in m/s.	
Type:	Element
Format:	Char String
Defined values:	[0-9]+
Default value:	
Example:	<speed>23</speed>
Note:	This element is present if speed is possible to attain by the used positioning method.

5.3.80 start_time

Description:															
This element defines the absolute start time in a time range.															
Type:	Element														
Format:	Char String The time is expressed as yyyyMMddhhmmss where: <table border="1" data-bbox="423 1587 818 1850"> <thead> <tr> <th>String</th> <th>Description</th> </tr> </thead> <tbody> <tr> <td>yyyy</td> <td>Year</td> </tr> <tr> <td>MM</td> <td>Month</td> </tr> <tr> <td>dd</td> <td>Day</td> </tr> <tr> <td>hh</td> <td>Hours</td> </tr> <tr> <td>mm</td> <td>Minutes</td> </tr> <tr> <td>ss</td> <td>Seconds</td> </tr> </tbody> </table>	String	Description	yyyy	Year	MM	Month	dd	Day	hh	Hours	mm	Minutes	ss	Seconds
String	Description														
yyyy	Year														
MM	Month														
dd	Day														
hh	Hours														
mm	Minutes														
ss	Seconds														
Defined values:															

Default value:	
Example:	<start_time>20010630142810</start_time>
Note:	

5.3.80.1 utc_off

Description:	
Specifies the UTC [UTC] offset in hours and minutes. Positive values indicate time zones east of Greenwich.	
Type:	Attribute
Format:	Char string
Defined values:	[+ -]?0000-1400
Default value:	
Example:	<start_time utc_off="+0200">20020813010423</start_time>
Note:	utc_off is specified as 'HHMM', where 'HH' can range between 0-14 and 'MM' between '0-59'. All other values shall result in error 105, 'Format error'.

5.3.81 startAngle

Description:	
The start angle is the angle (in angularUnit) between North and the first defined radius.	
Type:	Element
Format:	Char string
Defined values:	0-359°
Default value:	
Example:	<startAngle>60</startAngle>
Note:	

5.3.82 stop_time

Description:													
This element defines the absolute stop time in a time range.													
Type:	Element												
Format:	Char String												
	The time is expressed as yyyyMMddhhmmss where:												
	<table border="1"> <thead> <tr> <th>String</th> <th>Description</th> </tr> </thead> <tbody> <tr> <td>yyyy</td> <td>Year</td> </tr> <tr> <td>MM</td> <td>Month</td> </tr> <tr> <td>dd</td> <td>Day</td> </tr> <tr> <td>hh</td> <td>Hours</td> </tr> <tr> <td>mm</td> <td>Minutes</td> </tr> </tbody> </table>	String	Description	yyyy	Year	MM	Month	dd	Day	hh	Hours	mm	Minutes
String	Description												
yyyy	Year												
MM	Month												
dd	Day												
hh	Hours												
mm	Minutes												

	ss	Seconds
Defined values:		
Default value:		
Example:	<stop_time>20020630142810</stop_time>	
Note:		

5.3.83 stopAngle

Description:	
The stop angle is the angle (in angularUnit) between the first and second defined radius.	
Type:	Element
Format:	Char string
Defined values:	1-360°
Default value:	
Example:	<stopAngle>180</stopAngle>
Note:	

5.3.83.1 utc_off

See section 5.3.80.1

5.3.84 strict

Description:	
Defines if civivloc is requested in location responses.	
Type:	Attribute
Format:	Char string
Defined values:	YES the returned position must only contain what was requested
	NO the returned position may differ from what was requested
Default value:	NO
Example:	<geoinfo strict="YES"></geoinfo>
Note:	

5.3.85 subclient

Description:	
Identifies the ASPs, resellers and portals in the chain of service providers between the network and the end-user	
Type:	Element
Format:	
Defined values:	
Default value:	
Example:	<subclient last_client="NO"> <id>TheASP</id> <serviceid>0006</serviceid>

	</subclient>
Note:	

5.3.85.1 last_client

Description:					
Identifies whether the SUBCLIENT is the last one in the chain or not					
Type:	Attribute				
Format:	Char String				
Defined values:	<table border="1"> <tr> <td>YES</td> <td>This is the last client – the one that the end-user is actually communicating with</td> </tr> <tr> <td>NO</td> <td>This is not the last client</td> </tr> </table>	YES	This is the last client – the one that the end-user is actually communicating with	NO	This is not the last client
YES	This is the last client – the one that the end-user is actually communicating with				
NO	This is not the last client				
Default value:	NO				
Example:	<subclient last_client="YES">				
Note:					

5.3.86 ta

Description:	
This Radio Access Network element that can be used to offer enhanced positioning. (Timing Advance)	
Type:	Element
Format:	Char string
Defined values:	0-63
Default value:	0
Example:	<ta>3</ta>
Note:	Further Information regarding this element can be found in the relevant GSM Specifications [05.10]

5.3.87 target_area

Description:	
Specify the target area in change_area event.	
Type:	Element
Format:	
Defined values:	
Default value:	
Example:	<pre><target_area> <name_area>Seoul</name_area> </target_area></pre>
Note:	

5.3.88 time

Description:															
In a location answer this element indicates the time when the positioning was performed.															
Type:	Element														
Format:	Char String The time is expressed as yyyyMMddhhmmss where: <table border="1" style="margin-left: 20px;"> <thead> <tr> <th>String</th> <th>Description</th> </tr> </thead> <tbody> <tr> <td>yyyy</td> <td>Year</td> </tr> <tr> <td>MM</td> <td>Month</td> </tr> <tr> <td>dd</td> <td>Day</td> </tr> <tr> <td>hh</td> <td>Hours</td> </tr> <tr> <td>mm</td> <td>Minutes</td> </tr> <tr> <td>ss</td> <td>Seconds</td> </tr> </tbody> </table>	String	Description	yyyy	Year	MM	Month	dd	Day	hh	Hours	mm	Minutes	ss	Seconds
String	Description														
yyyy	Year														
MM	Month														
dd	Day														
hh	Hours														
mm	Minutes														
ss	Seconds														
Defined values:															
Default value:															
Example:	<time>20010630142810</time>														
Note:															

5.3.88.1 utc_off

See section 5.3.83.1

5.3.89 time_remaining

Description:											
Defines the time remaining until the location server terminates the current triggered location service. The time when the service is valid is either specified by the client using start time and stop time, or is a network operator specific default value where no stop time is defined or where the stop time exceeds the allowed value by the location server involved.											
Type:	Element										
Format:	Char String The time is expressed as ddhhmmss where: <table border="1" style="margin-left: 20px;"> <thead> <tr> <th>String</th> <th>Description</th> </tr> </thead> <tbody> <tr> <td>dd</td> <td>Day</td> </tr> <tr> <td>hh</td> <td>Hours</td> </tr> <tr> <td>mm</td> <td>Minutes</td> </tr> <tr> <td>ss</td> <td>Seconds</td> </tr> </tbody> </table>	String	Description	dd	Day	hh	Hours	mm	Minutes	ss	Seconds
String	Description										
dd	Day										
hh	Hours										
mm	Minutes										
ss	Seconds										
Defined values:											
Default value:	The default value is defined in the location server										
Example:	<time_remaining>00010000</time_remaining>										
Note:											

5.3.90 trans_id

Description:	
An identifier originally provided by the client so it can associate responses to the original request	
Type:	Element
Format:	Char string
Defined values:	None
Default value:	None
Example:	<trans_id>uk999call04112417544312</trans_id>
Note:	trans_id is used to distinguish between multiple location requests of the same target. This implementation is not supported when a range of MSID's are requested by the client

5.3.91 trl_pos

Description:	
Specifies the position of the MS at a triggered location report.	
Type:	Element
Format:	
Defined values:	
Default value:	
Example:	<pre><trl_pos trl_trigger="PERIODIC"> <msid>4711</msid> <poserr> <result resid="1">SYSTEM FAILURE</result> <time utc_off="0100">20011127104532</time> </poserr> </trl_pos></pre>
Note:	

5.3.91.1 trl_trigger

Description:		
Specifies the trigger that initiated the positioning of the MS at a triggered location report.		
Type:	Attribute	
Format:	Char string	
Defined values:	PERIODIC	The positioning is triggered when the periodical timer expired
	MS_AVAIL	The positioning is triggered by the MS presence notification
	CHANGE_AREA	The positioning is triggered by the mobility event of the location of MS
Default value:		
Example:	<trl_pos trl_trigger="PERIODIC">	
Note:		

5.3.91.2 pos_method

See section 5.3.25.1

5.3.92 url

Description:	
Specifies the location to which a response to a TLRR, an asynchronous SLIR or an asynchronous eme_lir should be sent to	
Type:	Element
Format:	Char string
Defined values:	
Default value:	
Example:	<url>http://location.client.com/Response/</url>
Note:	URL is part of pushaddr element which may also contain id and pwd. These elements are used by the LCS Client to inform the Location Server what credentials to use when 'pushing' a location report to the LCS Client in the case of an asynchronous service.

5.3.93 vlrno

Description:	
Uniquely specifies a VLR within a network.	
Type:	Element
Format:	Char String
Defined values:	In GSM this is the Global Title address. The Global Title is in the same format as an E.164 number.
Default value:	
Example:	<vlrno>1541154871</vlrno>
Note:	

5.3.94 vmscno

Description:	
Uniquely specifies a VMSC within a network.	
Type:	Element
Format:	Char String
Defined values:	In GSM this is the Global Title address. The Global Title is in the same format as an E.164 number.
Default value:	
Example:	<vmscno>1541154871</vmscno>
Note:	

5.3.95 Width

Description:

This element specifies the requested width of map image	
Type:	Element
Format:	Char String
Defined values:	[0-9]+
Default value:	0
Example:	<Width>800</Width>
Note:	The default type of map width is defined as pixel.

5.3.96 X

Description:	
The first ordinate in a coordinate system	
Type:	Element
Format:	Char string
Defined values:	
Default value:	
Example:	<x>63500</x>
Note:	<p>For the default WGS84 CRS the presentation format is Degrees Minutes Seconds Hemisphere (DMSH), with fields separated by a space character and with leading zeros added to any minute or second values less than 10. Note that in the WGS84 CRS 'X' denotes the latitude of a position.</p> <p>For the default UTM CRS the presentation format is presented in meters. Note that in the UTM CRS 'X' denotes the easting of a position.</p>

5.3.97 Y

Description:	
Second ordinate in a coordinate system. This is optional if it is a linear coordinate system.	
Type:	Element
Format:	Char string
Defined values:	
Default value:	
Example:	<Y>4832438</Y>
Note:	<p>For the default WGS84 CRS the presentation format is Degrees Minutes Seconds Hemisphere (DMSH), with fields separated by a space character and with leading zeros added to any minute or second values less than 10. Note that in the WGS84 CRS 'Y' denotes the longitude of a position.</p> <p>For the default UTM CRS the presentation format is presented in meters. Note that in the UTM CRS 'Y' denotes the northing of a position.</p>

5.3.98 Z

Description:	
third ordinate in a coordinate system which has at least three ordinates	
Type:	Element
Format:	Char string
Defined values:	
Default value:	
Example:	<z>498</z>
Note:	The default Coordinate Reference System WGS84 (#4326 of the EPSG database) uses an "Ellipsoidal 2D Coordinate System". This means for a potential altitude value the parameter 'alt' (cf. 5.3.2 of MLP) is used.

5.3.99 Zone

Description:	
first and the mandatory component in the representation of a location in UTM coordinate system	
Type:	Element
Format:	Char string
Defined values:	1 to 60
Default value:	
Example:	<Zone>20</Zone>
Note:	Stands for Zone information of a position in UTM Coordinate System.

5.3.100 Zoom

Description:	
This element specifies the requested zoom level of zoom of map image	
Type:	Element
Format:	Char String
Defined values:	[0-9]+
Default value:	0
Example:	<Zoom>10.5</Zoom>
Note:	The default type of Zoom is KILOMETER.

5.3.100.1 ZoomType

Description:	
This element specifies the The zoomtype of Map Requestzoom level	
Type:	Attribute
Format:	Char String
Defined values:	KILOMETER
	METER
	MILE
	INCH
Default value:	KILOMETER

Example:	<Zoom ZoomType="KILOMETER">1</Zoom>
Note:	

Note:	A specific value of element_type may only occur once in a civic location (civicloc)
--------------	---

5.4 Result codes

5.4.1 Result codes

This table defines the result codes that indicate the result of the request or individual positioning. The error codes are divided in ranges:

0	-	99	Location server specific errors
100	-	199	Request specific errors
200	-	299	Network specific errors
300	-	499	Reserved for future use
500	-	599	Vendor specific errors
600	-	699	MLS Client specific errors

Note: For privacy reasons it might be needed to not report certain specific errors. In this case it is up to the implementation or configuration of the location server which errors will be reported.

Resid	Slogan	Description
0	OK	No error occurred while processing the request.
1	SYSTEM FAILURE	The request can not be handled because of a general problem in the location server.
2	UNSPECIFIED ERROR	An unspecified error used in case none of the other errors apply. This can also be used in case privacy issues prevent certain errors from being presented.
3	UNAUTHORIZED APPLICATION	The requesting location-based application is not allowed to access the location server or a wrong password has been supplied.
4	UNKNOWN SUBSCRIBER	Unknown subscriber. The user is unknown, i.e. no such subscription exists.
5	ABSENT SUBSCRIBER	Absent subscriber. The user is currently not reachable.
6	POSITION METHOD FAILURE	Position method failure. The location service fails to obtain the user's position. The exact cause may be indicated in ADD_INFO by the inclusion of an event code (A, B, C etc.) from the list below: A: Target does not support SUPL. B: SUPL Positioning Failure—Target does not support requested service. For example a SUPL 1.0 device doesn't support periodic trigger service. C: SUPL Positioning Failure—Target fails to deliver Cell Info.

		D: SUPL Positioning Failure—both Cell ID location and GNSS positioning fail.
7	TIMEOUT	Timer expiry for the requested event trigger
101	CONGESTION IN LOCATION SERVER	The request can not be handled due to congestion in the location server.
103	UNSUPPORTED VERSION	The Location server does not support the indicated protocol version.
104	TOO MANY POSITION ITEMS	Too many position items have been specified in the request.
105	FORMAT ERROR	A protocol element in the request has invalid format. The invalid element is indicated in ADD_INFO.
106	SYNTAX ERROR	The position request has invalid syntax. Details may be indicated in ADD_INFO.
107	PROTOCOL ELEMENT NOT SUPPORTED	A protocol element specified in the position request is not supported by the Location Server, or the position result is not supported by the LCS Client. The element is indicated in ADD_INFO.
108	SERVICE NOT SUPPORTED	The requested service is not supported in the Location Server. The service is indicated in ADD_INFO.
109	PROTOCOL ELEMENT ATTRIBUTE NOT SUPPORTED	A protocol element attribute is not supported in the Location Server. The attribute is indicated in ADD_INFO.
110	INVALID PROTOCOL ELEMENT VALUE	A protocol element in the request has an invalid value. The element is indicated in ADD_INFO.
111	INVALID PROTOCOL ELEMENT ATTRIBUTE VALUE	A protocol element attribute in the request has a wrong value. The element is indicated in ADD_INFO.
112	PROTOCOL ELEMENT VALUE NOT SUPPORTED	A specific value of a protocol element is not supported in the Location Server. The element and value are indicated in ADD_INFO.
113	PROTOCOL ELEMENT ATTRIBUTE VALUE NOT SUPPORTED	A specific value of a protocol element attribute is not supported in the Location Server. The attribute and value are indicated in ADD_INFO.
114	CANCELLATION OF TRIGGERED LOCATION REQUEST	The requested triggered location report is cancelled.
115	INVALID MSID IN TLRSR	One or more msid elements in the Triggered Location Reporting Stop Request are not valid to the Location Server.
116	TLRSR FOR INDIVIDUAL TARGET NOT SUPPORTED	The function of stopping triggered location reporting for individual target(s) is not supported in Location Server.
201	QOP NOT ATTAINABLE	The requested QoP cannot be provided. The exact QoP parameter which cannot be provided, i.e. accuracy, response time or max_loc_age, and value are indicated in ADD_INFO.
202	POSITIONING NOT ALLOWED	The subscriber does not allow the application to position him/her for whatever reason (privacy settings in location server, LCS privacy class).
203	CONGESTION IN MOBILE NETWORK	The request can not be handled due to congestion in the mobile network.
204	DISALLOWED BY LOCAL REGULATIONS	The location request is disallowed by local regulatory requirements.
207	MISCONFIGURATION OF LOCATION SERVER	The location server is not completely configured to be able to calculate a position.
208	TARGET MOVED TO NEW	The triggered Location Request has been aborted due to that

	MSC/SGSN	target has moved to another MSC/SGSN. This result code shall only be used towards The Home Location Server. Restrictions: - This code SHALL only be used in RLP. - This result code shall only be used towards The Home Location Server.
500 -599		Vendor specific errors
601	STANDARD LOCATION REPORT SERVICE NOT SUPPORTED	The MLS Client does not support the standard location report service.
602	MLS CLIENT ERROR	An error occurred in the MLS Client.
603	STANDARD LOCATION REPORT SERVICE NOT ACCEPTED	The standard location report was not accepted by the MLS Client.
604	SUBSCRIBER IN STANDARD LOCATION REPORT SERVICE NOT VALID	The subscriber in the Standard Location Report is not valid to the MLS Client.
605	INVALID SERVICE ID IN STANDARD LOCATION REPORT SERVICE	The service identity in the Standard Location Report is not valid to the MLS Client.

5.5 Adaptation to 3GPP LCS (Informative)

5.5.1 Version mapping between 3GPP TS23.271 and this specification

The following table shows the version number of this specification (OMA-TS-MLP-V3_3) fully conforming to a certain version of 3GPP TS23.271, i.e. the version of this specification for the correct reference in a certain version of the 3GPP specification.

3GPP TS23.271 version number	Conforming version number of OMA-LOC_MLP_Spec-V3_3
Release 5	Version 3.1
Release 6	Version 3.2
Release 7	Version 3.3

Note: In case there are versions not appearing in this table, it should be interpreted that such update did not affect the other specification. That is, the version number not appearing in the table should apply to the conformance mapping for the closest smaller version number in the table.

5.5.2 The terminology mapping table with 3GPP LCS Specifications

The following is a list of the terms in MLP used differently from the ones defined for 3GPP:

Term		Notes
MLP	3GPP	
Location Server	LCS Server	
MS (Mobile Station)	UE	
MSID (Mobile Station Identifier)	Identification of the target UE	

MPC (Mobile Positioning Centre)		There is no term applicable to 3GPP.
---------------------------------	--	--------------------------------------

5.5.3 The corresponding terms used for the location procedures in 3GPP LCS Definition

The following is a list of terms defined in MLP corresponding to the 3GPP LCS definition [23.271] for the location procedures.

Location procedures defined in 3GPP[23.271]		Services defined in MLP
Circuit Switched Mobile Terminating Location Request CS-MT-LR	LCS Service Request	Standard Location Immediate Request
	LCS Service Response	Standard Location Immediate Answer
CS-MT-LR without HLR Query - applicable to North America Emergency Calls only	LCS Service Request	Emergency Location Immediate Request
	LCS Service Response	Emergency Location Immediate Answer
Packet Switched Mobile Terminating Location Request PS-MT-LR	LCS Service Request	Standard Location Immediate Request
	LCS Service Response	Standard Location Immediate Answer
Network Induced Location Request NI-LR	Location Information	Emergency Location Report
Packet Switched Network Induced Location Request PS-NI-LR	Location Information	Emergency Location Report
Mobile Terminating Deferred Location Request	LCS Service Request	Triggered Location Reporting Request
	LCS Service Response(Provide Subscriber Location ack)	Triggered Location Reporting Answer
	LCS Service Response(Subscriber Location Report)	Triggered Location Report
Combined Periodical/Deferred Mobile Terminating Location Request	LCS Service Request	Triggered Location Reporting Request
	LCS Service Response(Provide Subscriber Location ack)	Triggered Location Reporting Answer
	LCS Service Response(Subscriber Location Report)	Triggered Location Report
Cancellation of a Deferred Location Request	LCS Cancel Service Request	Triggered Location Reporting Stop Request
	LCS Cancel Service Response	Triggered Location Reporting Stop Answer
Mobile Originating Location Request, Circuit Switched CS-MO-LR	Location Information	Standard Location Report
	Location Information Ack	Standard Location Report Answer
Mobile Originating Location	Location Information	Standard Location Report

Location procedures defined in 3GPP[23.271]		Services defined in MLP
Request, Packet Switched PS-MO-LR	Location Information Ack	Standard Location Report Answer

5.5.4 Error Mapping (Informative)

The following list provides a mapping between the errors defined for LCS in MAP (see [29.002]) and MLP (see section 5.4)

MAP error	MLP resid
Unknown subscriber	4
Unidentified Subscriber	4
Absent Subscriber	5
System failure	1
Facility Not Supported	6
Unexpected Data Value	1
Data missing	1
Unauthorised LCS Client with detailed reason	3
Position method failure with detailed reason.	6
Illegal Subscriber	2
Illegal Equipment	2
Unauthorized requesting network	2

5.6 HTTP Mapping

This section describes how to use MLP over the HTTP transport mechanism using "HTTP/1.1".

HTTP is a request/response protocol involving a server and a client. In the context of MLP, the client is referred to as the LCS Client and the server is the Location Server (GMLC/MPC). For more information about HTTP, refer to [RFC2616] and <http://www.w3.org>.

The Location Server MAY provide two socket ports for operation, one for encryption with SSL/TLS and one without. The reason for having one insecure port is that encryption can consume resources, and if the client is in a secure domain there might not be a need for encryption. Applications residing in an insecure domain, i.e. on the Internet, may use the secure port to ensure the security and privacy of the location information.

For further information about SSL/TLS see [RFC2246].

Four port numbers have been selected and proposed as standard ports for location servers implementing MLP. These ports are registered with IANA (Internet Assigned Numbers Authority, see [IANA]). The four port numbers are:

lif-mlp	9210/tcp	LIF Mobile Loen Protocol
lif-mlp	9210/udp	LIF Mobile Loen Protocol
lif-mlp-s	9211/tcp	LIF Mobile Loen Secure
lif-mlp-s	9211/udp	LIF Mobile Loen Secure

A Location Server MAY choose to introduce any other socket based or HTTP transparent technology for secure transfers. Any such technology SHALL be provided over a different port than the four mentioned above.

5.6.1 Location Services using HTTP

An LCS Client SHALL request a Location Service by issuing an HTTP POST request towards the Location Server. For more information about HTTP POST, see [RFC2616]. The request line syntax is shown below.

```
Request-line =          POST SP path SP HTTP/1.1 CRLF
```

The request MUST include the entity-header Content-length field as part of the request. The message body of the request SHALL include the XML formatted request and SHALL have the length specified by the LCS Client in the Content-length field.

If the request is a triggered request the result SHALL be delivered to the LCS client through an HTTP POST operation issued by the Location Server. This implies that the LCS client MUST be able to receive HTTP POST requests and give a valid response.

All Location Services are invoked by sending a request using HTTP POST to a certain URI. An example of an URI is shown below.

```
http:// location-server.example.com:9210/LocationQueryService/
```

The response to the invocation of a Location Service SHALL be returned using an HTTP response.

If the LCS client requests standard location of asynchronous mode, triggered reporting of location, the Location Server SHALL return the report by performing an HTTP POST operation towards the client. The client must specify the URI that the answer should be posted to. This is done in the service request or by having it in the LCS client profile that can be stored in the Location Server.

The report SHALL be included in the message body and the Content-length entity SHALL be set to the length of the answer.

When an LCS client attempts to invoke a service request that is not defined in this specification, the Location Server SHALL return a General Error Message (GEM) in a HTTP '404' error response:

```
Status-Line=          HTTP/1.1 SP 404 SP Not Found CRLF
```

5.6.2 Request and Response Encapsulation

A request SHALL have a header part and a body part. A response MAY have a header part and SHALL have a body part. To be able to make a location request with a single XML document the header and the body are encapsulated in the same service initiation DTD. The context header holds the authentication and authorization data pertinent to a particular location request. The body part is described in the sections 5.2.3.2- 5.2.3.6.

5.6.2.1 Service Initiation DTD

```
<!-- MLP_SVC_INIT -->
```

```

<!--
MLP V3.3 Document Type Definition

Copyright Open Mobile Alliance Ltd., 2008
    All rights reserved

MLP is an XML language. Typical usage:
<?xml version="1.0"?>
  <!DOCTYPE svc_init PUBLIC "-//OMA//DTD {abbrev x.y}//EN"
    "http://www.openmobilealliance.org/DTD/{filename}"
    [<?oma-{ref}-ver supported-versions="{versions}"?>]>
  <svc_init>
    ...
  </svc_init>

Terms and conditions of use are available from the
Open Mobile Alliance Ltd. web site at
http://www.openmobilealliance.org/
-->

<!ENTITY    % extension.message      "">

<!ELEMENT   svc_init                 (hdr, (slir | eme_lir | tlrr | tlrsr | hlir
%extension.message;))>

<!ATTLIST   svc_init
    ver CDATA                          #FIXED "3.3.0">

<!ENTITY    %
    mlp_id_qop_res_shape.dtd          SYSTEM "MLP_ID_QOP_RES_SHAPE_330.DTD">
%mlp_id_qop_res_shape.dtd;

```

Example

```

<?xml version="1.0" ?>
<!DOCTYPE svc_init SYSTEM "MLP_SVC_INIT_330.DTD">
<svc_init ver="3.3.0">
  <hdr ver="3.3.0">
    ...
  </hdr>
  <slir ver="3.3.0">
    ...
  </slir>
</svc_init>

```

5.6.2.2 Service Result DTD

```

<!-- MLP_SVC_RESULT -->
<!--
MLP V3.3 Document Type Definition

Copyright Open Mobile Alliance Ltd., 2008
    All rights reserved

MLP is an XML language. Typical usage:
<?xml version="1.0"?>
  <!DOCTYPE svc_result PUBLIC "-//OMA//DTD {abbrev x.y}//EN"

```

```

"http://www.openmobilealliance.org/DTD/{filename}"
[<?oma-{ref}-ver supported-versions="{versions}"?>]
<svc_result>
...
</svc_result>

Terms and conditions of use are available from the
Open Mobile Alliance Ltd. web site at
http://www.openmobilealliance.org/
-->

<!ENTITY    % extension.message    "">
<!ELEMENT   svc_result             (hdr?, (slia | slirep | slrep | slra | eme_lia | emerep |
eme_lirep | tlra | tlrep | tlrsa | hlia | hlirep
%extension.message;))>

<!ATTLIST   svc_result
ver CDATA   #FIXED "3.3.0">

```

Example

```

<?xml version="1.0" ?>
<!DOCTYPE svc_result SYSTEM "MLP_SVC_RESULT_320.DTD">
<svc_result ver="3.3.0">
  <slia ver="3.3.0">
    ...
  </slia>
</svc_result>

```

5.6.2.3 Message Sequence Diagram

The following HTTP sequence (cf. Figure 9) is used for all the defined service requests/responses in MLP.

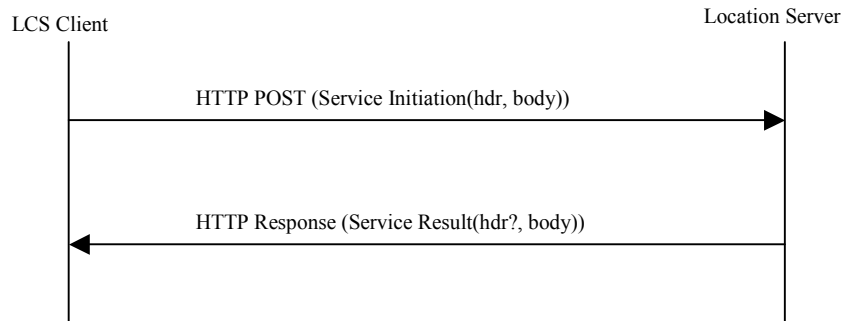

Figure 9: HTTP sequence for MLP request/response pairs

The following HTTP sequence diagram (cf. Figure 10) is used for all defined reports in MLP except for Standard Location Report.

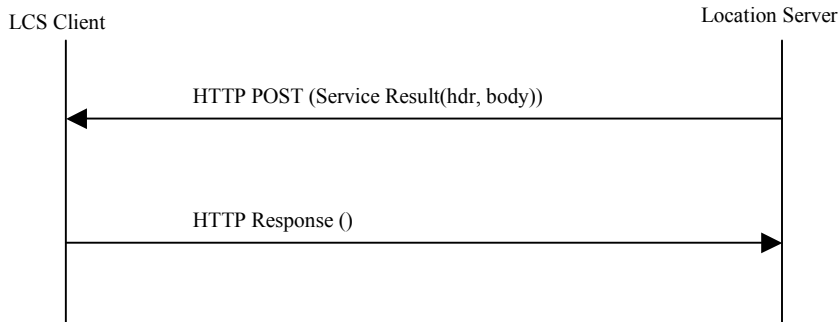

Figure 10: HTTP sequence for MLP reports

The following HTTP sequence diagram (cf. Figure 11) is used for the report and answer in Standard Location Reporting Service.

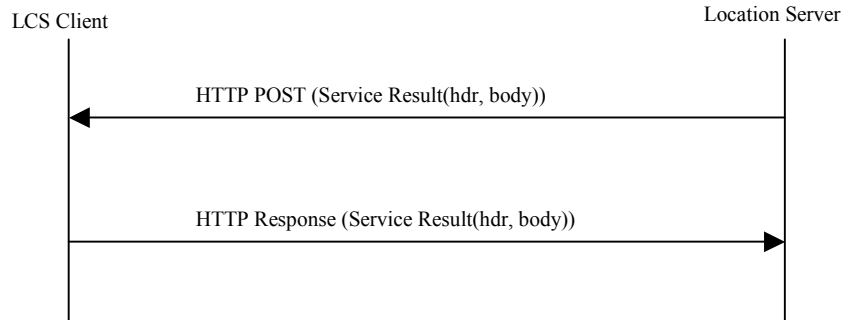

Figure 11: HTTP sequence for MLP Standard Location Reporting Service.

The following HTTP sequence diagram (cf. Figure 12) is used in the case of a General Error Message.

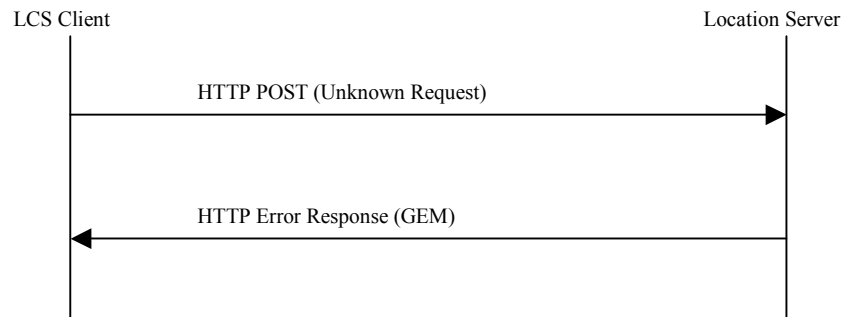

Figure 12: HTTP sequence for the General Error Message

5.7 Geographic Information

5.7.1 Coordinate Reference systems (Informative)

The study of determining the relative positions on or close to the surface of the earth is a complex science, referred to as geodesy. A complete definition of Coordinate Reference systems is not within the scope of this standard. This section

includes a brief overview of the subject. For more details see the OpenGIS© Consortium Abstract Specification Topic 2 [AST].

5.7.1.1 The Geoid, ellipsoids and datums

The Geoid is a physically realizable surface defined by the set of points with equal gravity potential approximately at the Mean Sea Level. While this surface is measurable it is not easy to define mathematically. In order to use known mathematics, the Geoid is approximated by an ellipsoid (spheroid).

There are many ellipsoids, each defined to best approximate some part of the Geoid. These ellipsoids are defined by an ellipse that is rotated about the major axis. There are many methods for defining an ellipse, the most common used in Geodesy the length of the semi-major axis and the flattening. This defines a mathematical ellipsoid for calculations. It does not provide enough information to locate the ellipsoid with respect to the Geoid or other ellipsoids. To locate the ellipsoid in space a datum is defined. Some of the common ellipsoids are WGS84, Bessel1841, Clark 1866.

A datum is the ellipsoid with its position in space. The position is defined by the origin and orientation of the ellipsoid with respect to the Geoid. Different datums locate latitude, longitude at different positions in space. For example ellipsoids Samboja, CH1903 and Stockholm are each based on Bessel1841, the National Geodetic Network and World Geodetic System 1984 are based on WGS84.

5.7.1.2 Coordinate systems

A coordinate system is the link between the datum and the coordinate values. It defines all of the information about the axes system that defines the values. The names of the axes, their units (formats), the order of ordinates ((Easting, Northing) versus (Northing, Easting)) and the angle between the axes are defined by the coordinate system.

5.7.1.2.1 Cartesian coordinate systems

A Cartesian coordinate system is defined by values of (x,y,z) . x is the distance from the x -axis, y is the distance from the y -axis, z the distance from the z -axis. The axes are orthogonal to each other. The unit used for x , y , z are a distance unit, such as meter. These coordinate systems are used for flat 'planar' descriptions of points. In general they are used over small areas where a projection method has been used to minimize distortions of the geography in the area.

5.7.1.2.2 Ellipsoid coordinates

More global geographic calculations need to take the surface of the earth into account. So we need a second coordinate system that describes each position relative to other points and lines on the earth's surface.

Each point can then be described as set of values (longitude, latitude) or (longitude, latitude, altitude) giving a point on the ellipsoid or relative to the ellipsoid we choose to describe the earth (cf. Figure 13). The longitude tells us how far east we have to move on the equator from the null-meridian, the latitude tells us how far north to move from the equator and the altitude tells us how far above the ellipsoid to go to finally reach the location. Negative values direct us to go in the opposite direction.

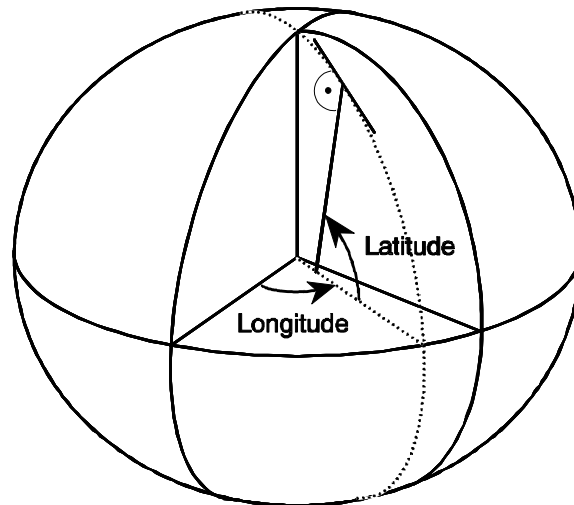

Figure 13: Ellipsoid Coordinates

5.7.1.3 Coordinate Reference Systems

The two coordinate reference systems relevant to this protocol are Geographic 2D Coordinate Reference Systems and Projected Coordinate Reference Systems.

Geographic 2D Coordinate Reference Systems describe locations on the ellipsoid. They are used for large national or continental geodetic networks. In particular GPS uses the Geographic 2D Coordinate Reference System WGS84. This uses the World Geodetic System 1984 based on the WGS84 ellipsoid. The coordinate axes have units of decimal degrees (or DMSH) with ordinate order (Northing, Easting). This Coordinate Reference System is the default for all basic MLP service requests and responses. A GMLC is only required to support WGS84. The GMLC geographies that are defined with altitude are modeled in this protocol as geographies in a Geographic 2D CRS with a separate altitude element, not as a Geographic 3D CRS. The geographies are planar and carrying a constant z value is not desirable.

There are several ways to convert ellipsoid coordinates to 2 dimensional cartesian coordinates. These are called projection methods. Each method is designed to minimize some type of distortion in the mapping for the ellipsoid to the 2D Cartesian coordinate system.

Projected Coordinate Reference Systems are used for map display, to allow Cartesian mathematics and for Advanced Location Services.

5.7.2 Coordinate Reference System Transformations (Informative)

A transformation is used to define a point in one CRS into the appropriate values in a second CRS. When the datums are the same, the transformation can frequently be defined by equations. A transformation from one datum to another is usually done with a least squares approximation. Transformation equations are available in from several places, transformation services are also available.

5.7.3 Methodology for defining CRSs and transformations in this protocol (Informative)

The MLP protocol defines the CRS by citing an authority and the unique reference identifier for the CRS defined by this authority. This leaves the definition of many CRS used over the world to be defined by a group of geodesy experts. This methodology is used by the OpenGIS© Consortium and the ISO TC 211 working group for well-known CRS. The encoding

used is from the OpenGIS® Consortium Recommendation Paper 01-014r5: Recommended Definition Data for Coordinate Reference Systems and Coordinate Transformations [CRS].

The MLP protocol may use the {EPSG} authority as an example. Support of other authority is for further study. This database is defined by a Microsoft Access database which can be found at www.epsg.org. An xml version of this database will be available at <http://www.opengis.net/gml/srs/epsg.xml> in the future.

The default WGS84 CRS is defined to be 4326 by the EPSG authority. Other examples are 326xx define the UTM xx N zones.

EPSG recommends that real numbers are used for internal data processing but that for interfacing with human beings the preferred representation be degree, minute, second, hemisphere (DMSH). For geographic coordinate reference systems with coordinate systems in degrees.

Where the value is held in several fields, as for example in DMSH representation, various symbols, words or character strings are in use as field identifiers and separators. For DMSH representation EPSG recommends that the degree, minute and second units are indicated through the suffixed symbols ° ' " (ASCII character codes 186, 39 and 34) respectively, for example 35°45'09.18"N, 65°45'09.18"W. Spaces are excluded from the separator and for minute and second values under 10 leading zeroes are included.

5.7.4 Supported coordinate systems and datum (Normative)

All MLP implementations MUST support at least the WGS84 Coordinate Reference System.

5.7.5 Shapes representing a geographical position (Informative)

There are a number of shapes used to represent a geographic area that describes where a mobile subscriber is located. There are additional shapes that are required for advanced MLP services. The standards bodies for geographic data for advanced MLP services such as routing, geocoding, coordinate conversion, and map display are the Location Interoperability Forum, the OpenGIS® Consortium and the ISO TC211 working group. The current public XML specification defining geography from these groups is GML V211 [GML]. These two groups work together and are working towards a GML V3 with additional geometry and topology types. The geometry required for the MLP is the GMLV211 with additional polygon types with boundaries that contain circles, ellipses or circular arcs. GML V3 will define the linear curves segments to allow these polygons to be defined. These boundaries will be defined as special cases of polygons, using the given interpolation methods. The following geographies are defined in this protocol. The relevant OGC Abstract Specification is Topic 1 [GEO].

5.7.5.1 Ellipsoid point

This a point on the ellipsoid and is modeled as a point in a Geographic 2D Coordinate Reference Systems.

5.7.5.2 Ellipsoid point with uncertainty circle

An ellipsoid point with uncertainty circle is characterized by the coordinates of an ellipsoid point (the origin) and a radius, "r" (cf. Figure 14). It describes the set of points on the ellipsoid, which are at a distance from the point of origin less than or equal to "r". This shape can be used to indicate points on the Earth surface, or near the Earth surface. This shape is a special case of a polygon with no interior boundaries.

The typical use of this shape is to indicate a point when its position is known only with a limited accuracy.

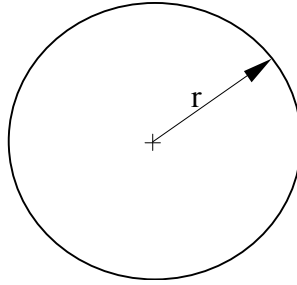

Figure 14: Ellipsoid point with uncertainty circle

5.7.5.3 Ellipsoid point with uncertainty ellipse

The shape of an "ellipsoid point with uncertainty ellipse" is characterized by the following (cf. Figure 15):

- The coordinates of an ellipsoid point (the origin)
- The distances r_1 and r_2
- The angle of orientation A

It describes formally the set of points on the ellipsoid, which fall within or on the boundary of an ellipse. This ellipse has a semi-major axis of length r_1 oriented at angle A (0 to 180°) measured clockwise from north and a semi-minor axis of length r_2 . The distances being the geodesic distance over the ellipsoid, i.e., the minimum length of a path staying on the ellipsoid and joining the two points, as shown in figure below.

As for the ellipsoid point, this can be used to indicate points on the Earth's surface, or near the Earth's surface, of same latitude and longitude. This shape is a special case of a polygon with no interior boundaries.

The typical use of this shape is to indicate a point when its position is known only with a limited accuracy, but the geometrical contributions to uncertainty can be quantified.

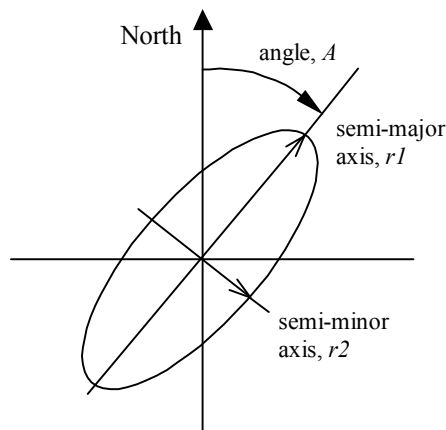

Figure 15: Ellipsoid point with uncertainty ellipse

5.7.5.4 Ellipsoid point with uncertainty arc

The shape of an "ellipsoid point with uncertainty arc" is characterized by the following (cf. Figure 16):

- The coordinates of an ellipsoid point (the origin)
- The inner radius(r_1) and uncertainty radius(r_2),
- The offset angle (θ) and included angle (β)

An arc is defined by a point of origin with one offset angle and one uncertainty angle plus one inner radius and one uncertainty radius. In this case the striped area describes the actual arc area. The smaller arc defines the inner radius(r_1) and the difference between inner and the outer arc defines the uncertainty radius(r_2). This shape is a special case of a polygon with no interior boundaries.

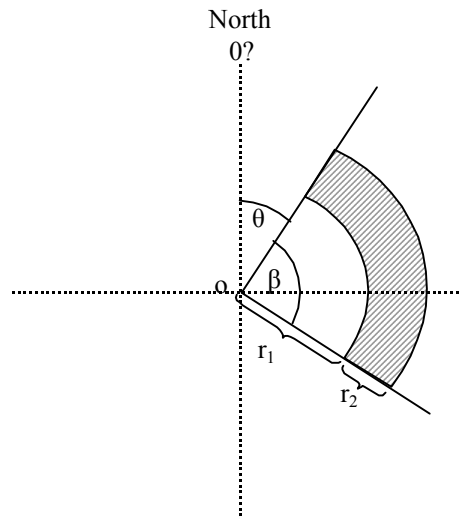

Figure 16: Ellipsoid point with uncertainty arc

5.7.5.5 Polygon

A Polygon is a connected surface. Any pair of points in the polygon can be connected to one another by a path. The boundary of the Polygon is a set of LinearRings. We distinguish the outer (exterior) boundary and the inner (interior) boundaries; the LinearRings of the interior boundary cannot cross one another and cannot be contained within one another. There must be at most one exterior boundary and zero or more interior boundary elements. The ordering of LinearRings and whether they form clockwise or anti-clockwise paths is not important. The minimum number of points allowed in a LinearRing is 3.

A LinearRing is a closed, simple piece-wise linear path which is defined by a list of coordinates that are assumed to be connected by straight line segments. The last coordinate must be coincident with the first coordinate and at least four coordinates are required (the three to define a ring plus the fourth duplicated one). This geometry is only used in the construction of a Polygon.

For basic MLP services polygons are the number of interior boundaries MUST be 0. Also to conform to [23.032] the maximum number of points allowed in an exterior boundary is 15. The points shall be connected in the order that they are given.

The described area is situated to the right of the exterior boundaries and left of the interior boundaries with the downward direction being toward the Earth's center and the forward direction being from a point to the next.

Note: This definition does not permit connecting lines greater than roughly 20 000 km. If such a need arises, the polygon can be described by adding an intermediate point.

Computation of geodesic lines is not simple. Approximations leading to a maximum distance between the computed line and the geodesic line of less than 3 meters are acceptable.

5.7.5.6 LineString

A LineString is a piece-wise linear path defined by a list of coordinates that are assumed to be connected by straight line segments. A closed path is indicated by having coincident first and last coordinates. At least two coordinates are required.

5.7.5.7 Box

The Box element is used to encode extents. Each <Box> element encloses a sequence of two <coord> elements containing exactly two coordinate tuples; the first of these is constructed from the minimum values measured along all axes, and the second is constructed from the maximum values measured along all axes

5.7.5.8 Geometries Collections

These are geometry objects that contain 2 or more primitive geometry objects. These collections can either be homogenous, a set of points, or heterogeneous, a point, circularArea and a LineString.

Geometry collections are not valid for the basic MLP services.

Appendix A. Change History

(Informative)

A.1 Approved Version History

Reference	Date	Description
n/a	n/a	No prior version –or- No previous version within OMA

A.2 Draft/Candidate Version V3_3 History

Type of Change	Date	Section	Description
Draft Version: OMA-TS-MLP	05 Feb 2007	5	New TS template introduced for MLS 1.2
	19 June 2007	5.2.3.2	OMA-LOC-2007-0107R01-CR_MLP_3_3_TS_Intermediate_Location_changes.doc
		5.2.3.3	OMA-LOC-2007-0173R02-CR_MLP3.3_TLRSR_for_Individual_Targets.doc
		5.2.3.6	
	30 Aug 2007	All	OMA-LOC-2007-0260-CR_MLS_1_2_TS_MLP_HistoricLocations.doc
			OMA-LOC-2007-0262-CR_MLS_1_2_TS_MLP_IntermediateReports_Service_DTD.doc
			OMA-LOC-2007-0274-CR_MLS_1_2_TS_MLP_SuplEmergency.doc
			OMA-LOC-2007-0275R02-CR_MLS_1_2_TS_MLP_CivicLocation.doc
			OMA-LOC-2007-0282-CR_MLS1.2_TS_SCR_update_about_TLRSR_and_TLRSA.doc
	03 Dec 2007	5.2 5.3	OMA-LOC-2007-0295-CR_MLS_1_2_TS_MLP_AddRequestorIdTypes.zip
			OMA-LOC-2007-0380R03-CR_MLP_3_3_define_Zone.zip
	21 Dec 2007	5.2 5.3 5.6	OMA-LOC-2007-0379R03-CR_MLP_3_3_TS_define_oMapRequest.zip
			OMA-LOC-2007-0403R01-CR_MLS_1_2_TS_MLP_NumberOfDTD.zip
OMA-LOC-2007-0405-CR_MLS_1_2_TS_MLP_CorrectionsDTD.zip OMA-LOC-2007-0447-CR_MLP3_3_TS_add_lang_to_civiloc.zip			
8 Mar 2008	5.2 5.3 5.4	OMA-LOC-2008-0102-CR_MLS_1_2_TS_MLP_editorial_change	
		OMA-LOC-2008-0048R02-CR_MLS_1_2_TS_MLP_Galileo	
		OMA-LOC-2008-0049-CR_MLS_1_2_TS_MLP_NAI_Subscriber_ID	
		OMA-LOC-2008-0057-CR_MLS_1_2_TS_MLP_Conr_C003_004_periodicMode	
		OMA-LOC-2008-0058-CR_MLS_1_2_TS_MLP_Conr_C005_To_007_TriggerStop	
		OMA-LOC-2008-0059-CR_MLS_1_2_TS_MLP_Conr_C008_033_SCR	
		OMA-LOC-2008-0103R01-CR_MLS_1_2_TS_MLP_element_definition	
		OMA-LOC-2008-0119-CR_MLS_1_2_TS_MLP_Conr_C038_interval OMA-LOC-2008-0168-CR_MLS1_2_TS_MLP_Area_Event_Types	
3 Apr 2008	5.2	OMA-LOC-2008-0177-CR_MLS1_2_TS_MLP_CONRR_C011.zip	
		OMA-LOC-2008-0178R01-CR_MLS1_2_TS_MLP_CONRR_C012.zip	
		OMA-LOC-2008-0180-CR_MLS1_2_TS_MLP_CONRR_C032.zip	
10 Apr 2008	All	OMA-LOC-2008-0060R02-INP_MLS_1_2_CONRR_20080219.zip	
21 Apr 2008	5.2 5.3	OMA-LOC-2008-0060R03-INP_MLS_1_2_CONRR_20080219.zip	
21 Apr 2008	5.4, App B	OMA-LOC-2008-0208-CR_MLS_1_2_TS_MLP_editorial_change.zip	
		OMA-LOC-2008-0267R02-CR_MLS_1_2_TS_MLP_more result code.zip	
Candidate Version: OMA-TS-MLP-V3_3	27 Jun 2008	n/a	Status changed to Candidate by TP TP ref#: OMA-TP-2008-0221-INP_LOC_MLS_V1.2_for_Candidate_Approval
Draft version	2 mar -2009	2, 5.3	OMA-LOC-2008-0504-CR_MLS_1_2_TS_MLP_Ref_RCF5139.zip
Draft version	3 Sep 2009	5.2.2.3	OMA-LOC-2009-0222R01-CR_MLP_3_3_TS_Add_Pos_Method
		5.3.25.1	
Candidate Version: OMA-TS-MLP-V3_3	01 Oct 2009	n/a	Status changed to Candidate by TP TP ref#: OMA-TP-2009-0357-INP_MLS_1.2_ERP_for_Candidate_re_approval

Appendix B. Static Conformance Requirements (Normative)

The notation used in this appendix is specified in [IOPPROC].

B.1 SCR for Client

B.1.1 Service Initiation DTD

Item	Function	Reference	Status	Requirement
MLP-A-C-001	Service Initiation	5.6.2.1	M	MLP-A-C-002 AND MLP-A-C-003
MLP-A-C-002	Header	5.6.2.1	M	
MLP-A-C-003	Standard Location Immediate Request	5.6.2.1	O	MLP-B-C-003 AND MLP-B-C-004
MLP-A-C-004	Emergency Location Immediate Request	5.6.2.1	O	MLP-B-C-007
MLP-A-C-005	Triggered Location Reporting Request	5.6.2.1	O	MLP-B-C-010 AND MLP-B-C-011 AND MLP-B-C-012
MLP-A-C-006	Triggered Location Reporting Stop Request	5.6.2.1	O	MLP-B-C-012
MLP-A-C-008	Historic Location Immediate Request	5.6.2.1	O	MLP-B-C-014
MLP-A-C-007	Extension Message	5.6.2.1	O	

B.1.2 Service Result DTD

Item	Function	Reference	Status	Requirement
MLP-B-C-001	Service Result	5.6.2.2	M	MLP-B-C-002 AND MLP-B-C-003
MLP-B-C-002	Header	5.6.2.2	O	
MLP-B-C-003	Standard Location Immediate Answer	5.6.2.2	O	
MLP-B-C-004	Standard Location Immediate Report	5.6.2.2	O	
MLP-B-C-005	Standard Location Report	5.6.2.2	O	
MLP-B-C-006	Standard Location Report Answer	5.6.2.2	O	
MLP-B-C-007	Emergency Location Immediate Answer	5.6.2.2	O	
MLP-B-C-008	Emergency Location Immediate Report	5.6.2.2	O	MLP-B-C-007
MLP-B-C-009	Emergency Location Report	5.6.2.2	O	
MLP-B-C-010	Triggered Location Reporting Answer	5.6.2.2	O	MLP-B-C-011
MLP-B-C-011	Triggered Location Report	5.6.2.2	O	MLP-B-C-010
MLP-B-C-012	Triggered Location Reporting Stop Answer	5.6.2.2	O	
MLP-B-C-014	Historic Location Immediate Answer	5.6.2.2	O	

Item	Function	Reference	Status	Requirement
MLP-B-C-015	Historic Location Immediate Report	5.6.2.2	O	
MLP-B-C-013	Extension Message	5.6.2.2	O	

B.1.3 Header

Item	Function	Reference	Status	Requirement
MLP-C-C-001	client	5.2.3.1	M	
MLP-C-C-002	sessionid	5.2.3.1	O	
MLP-C-C-003	subclient	5.2.3.1	O	
MLP-C-C-004	requestor	5.2.3.1	O	

B.1.4 Standard Location Immediate Request

Item	Function	Reference	Status	Requirement
MLP-D-C-001	msids	5.2.3.2.1	O	
MLP-D-C-002	msid	5.2.3.2.1	M	
MLP-D-C-003	codeword	5.2.3.2.1	O	
MLP-D-C-004	gsm_net_param	5.2.3.2.1	O	
MLP-D-C-005	trans_id	5.2.3.2.1	O	
MLP-D-C-006	eqop	5.2.3.2.1	O	
MLP-D-C-007	geo_info	5.2.3.2.1	O	
MLP-D-C-008	loc_type	5.2.3.2.1	O	
MLP-D-C-009	prio	5.2.3.2.1	O	
MLP-D-C-010	pushaddr	5.2.3.2.1	O	
MLP-D-C-011	service_coverage	5.2.3.2.1	O	
MLP-D-C-013	MapRequest	5.2.2.10.1	O	
MLP-D-C-012	extension parameter	5.2.3.2.1	O	

B.1.5 Standard Location Immediate Answer

Item	Function	Reference	Status	Requirement
MLP-E-C-001	pos	5.2.3.2.2	M	
MLP-E-C-002	req_id	5.2.3.2.2	O	
MLP-E-C-003	result	5.2.3.2.2	M	
MLP-E-C-004	add_info	5.2.3.2.2	O	
MLP-E-C-005	extension parameter	5.2.3.2.2	O	

B.1.6 Standard Location Immediate Report

Item	Function	Reference	Status	Requirement
MLP-F-C-001	req_id	5.2.3.2.3	M	MLP-E-C-002
MLP-F-C-002	pos	5.2.3.2.3	M	
MLP-F-C-003	extension parameter	5.2.3.2.3	O	

B.1.7 Emergency Location Immediate Request

Item	Function	Reference	Status	Requirement
MLP-G-C-001	msids	5.2.3.3.1	O	
MLP-G-C-002	msid	5.2.3.3.1	M	
MLP-G-C-003	gsm_net_param	5.2.3.3.1	O	
MLP-G-C-004	trans_id	5.2.3.3.1	O	
MLP-G-C-005	esrd	5.2.3.3.1	O	
MLP-G-C-006	esrk	5.2.3.3.1	O	
MLP-G-C-007	eqop	5.2.3.3.1	O	
MLP-G-C-008	geo_info	5.2.3.3.1	O	
MLP-G-C-009	loc_type	5.2.3.3.1	O	
MLP-G-C-010	pushaddr	5.2.3.3.1	O	
MLP-G-C-012	supl_support_params	5.2.3.3.1	O	
MLP-G-C-013	MapRequest	5.2.2.11.1	O	
MLP-G-C-011	extension parameter	5.2.3.3.1	O	

B.1.8 Emergency Location Immediate Answer

Item	Function	Reference	Status	Requirement
MLP-H-C-001	eme_pos	5.2.3.3.2	M	
MLP-H-C-002	req_id	5.2.3.3.2	O	
MLP-H-C-003	result	5.2.3.3.2	M	
MLP-H-C-004	add_info	5.2.3.3.2	O	
MLP-H-C-005	extension parameter	5.2.3.3.2	O	

B.1.9 Emergency Location Immediate Report

Item	Function	Reference	Status	Requirement
MLP-I-C-001	req_id	5.2.3.3.3	M	MLP-H-C-002
MLP-I-C-002	eme_pos	5.2.3.3.3	M	
MLP-I-C-003	result	5.2.3.3.3	M	
MLP-I-C-004	add_info	5.2.3.3.3	O	
MLP-I-C-005	extension parameter	5.2.3.3.3	O	

B.1.10 Standard Location Report

Item	Function	Reference	Status	Requirement
MLP-J-C-001	pos	5.2.3.4.1	M	
MLP-J-C-002	extension parameter	5.2.3.4.1	O	

B.1.11 Standard Location Report Answer

Item	Function	Reference	Status	Requirement
MLP-K-C-001	result	5.2.3.4.2	M	
MLP-K-C-002	add_info	5.2.3.4.2	O	

Item	Function	Reference	Status	Requirement
MLP-K-C-003	extension parameter	5.2.3.4.2	O	

B.1.12 Emergency Location Report

Item	Function	Reference	Status	Requirement
MLP-L-C-001	eme_event	5.2.3.5.1	M	
MLP-L-C-002	extension parameter	5.2.3.5.1	O	

B.1.13 Triggered Location Reporting Request

Item	Function	Reference	Status	Requirement
MLP-M-C-001	msids	5.2.3.6.1	M	
MLP-M-C-002	interval	5.2.3.6.1	O	
MLP-M-C-003	start_time	5.2.3.6.1	O	
MLP-M-C-004	stop_time	5.2.3.6.1	O	
MLP-M-C-005	duration	5.2.3.6.1	O	
MLP-M-C-006	tlrr_event	5.2.3.6.1	O	
MLP-M-C-007	qop	5.2.3.6.1	O	
MLP-M-C-008	geo_info	5.2.3.6.1	O	
MLP-M-C-009	pushaddr	5.2.3.6.1	O	
MLP-M-C-010	loc_type	5.2.3.6.1	O	
MLP-M-C-011	prio	5.2.3.6.1	O	
MLP-M-C-012	service_coverage	5.2.3.6.1	O	
MLP-M-C-014	MapRequest	5.2.2.14.1	O	
MLP-M-C-013	extension parameter	5.2.3.6.1	O	

B.1.14 Triggered Location Reporting Answer

Item	Function	Reference	Status	Requirement
MLP-N-C-001	req_id	5.2.3.6.2	M	
MLP-N-C-002	result	5.2.3.6.2	M	
MLP-N-C-003	add_info	5.2.3.6.2	O	
MLP-N-C-004	extension parameter	5.2.3.6.2	O	
MLP-N-C-005	lcs_ref	5.2.3.6.2	O	

B.1.15 Triggered Location Report

Item	Function	Reference	Status	Requirement
MLP-O-C-001	req_id	5.2.3.6.3	M	
MLP-O-C-002	trl_pos	5.2.3.6.3	M	
MLP-O-C-003	time_remaining	5.2.3.6.3	O	
MLP-O-C-004	extension parameter	5.2.3.6.3	O	
MLP-N-C-005	lcs_ref	5.2.3.6.3	O	

B.1.16 Triggered Location Reporting Stop Request

Item	Function	Reference	Status	Requirement
MLP-P-C-001	req_id	5.2.3.6.4	M	
MLP-P-C-002	msids	5.2.3.6.4	O	
MLP-P-C-003	extension parameter	5.2.3.6.4	O	
MLP-P-C-004	lcs_ref	5.2.3.6.4	O	

B.1.17 Triggered Location Reporting Stop Answer

Item	Function	Reference	Status	Requirement
MLP-Q-C-001	req_id	5.2.3.6.5	M	
MLP-Q-C-002	msids	5.2.3.6.5	O	
MLP-Q-C-003	result	5.2.3.6.5	M	
MLP-Q-C-004	add_info	5.2.3.6.5	O	
MLP-Q-C-005	extension parameter	5.2.3.6.5	O	

B.1.18 Historic Location Immediate Request

Item	Function	Reference	Status	Requirement
MLP-AC-C-002	msid	5.2.3.8.1	M	
MLP-AC-C-005	trans_id	5.2.3.8.1	O	
MLP-AC-C-005	start_time	5.2.3.8.1	O	
MLP-AC-C-005	stop_time	5.2.3.8.1	O	
MLP-AC-C-005	interval	5.2.3.8.1	O	
MLP-AC-C-005	qop	5.2.3.8.1	O	
MLP-AC-C-005	geo_info	5.2.3.8.1	O	
MLP-AC-C-010	pushaddr	5.2.3.8.1	O	
MLP-AC-C-009	prio	5.2.3.8.1	O	
MLP-AC-C-012	extension parameter	5.2.3.8.1	O	

B.1.19 Historic Location Immediate Answer

Item	Function	Reference	Status	Requirement
MLP-AD-C-001	pos	5.2.3.8.2	M	
MLP-AD-C-002	req_id	5.2.3.8.2	O	
MLP-AD-C-003	result	5.2.3.8.2	M	
MLP-AD-C-004	add_info	5.2.3.8.2	O	
MLP-AD-C-005	extension parameter	5.2.3.8.2	O	

B.1.20 Historic Location Immediate Report

Item	Function	Reference	Status	Requirement
MLP-AE-C-001	req_id	5.2.3.8.3	M	
MLP-AE-C-002	pos	5.2.3.8.3	M	
MLP-AE-C-003	extension parameter	5.2.3.8.3	O	

B.1.21 Support for Identity Elements

Item	Function	Reference	Status	Requirement
MLP-R-C-001	msid	5.2.2.1	M	
MLP-R-C-002	msid_range	5.2.2.1	O	
MLP-R-C-003	msids	5.2.2.1	O	
MLP-R-C-004	codeword	5.2.2.1	O	
MLP-R-C-005	esrd	5.2.2.1	O	
MLP-R-C-006	esrk	5.2.2.1	O	
MLP-R-C-007	session	5.2.2.1	O	
MLP-R-C-008	start_msid	5.2.2.1	O	
MLP-R-C-009	stop_msid	5.2.2.1	O	
MLP-R-C-010	trans_id	5.2.2.1	O	

B.1.22 Support for Function Elements

Item	Function	Reference	Status	Requirement
MLP-S-C-001	eme_event	5.2.2.2	O	
MLP-S-C-002	tlrr_event	5.2.2.2	O	
MLP-S-C-003	ms_action	5.2.2.2	O	
MLP-S-C-004	change_area	5.2.2.2	O	
MLP-S-C-005	target_area	5.2.2.2	O	
MLP-S-C-006	no_of_reports	5.2.2.2	O	
MLP-S-C-007	name_area	5.2.2.2	O	
MLP-S-C-008	plmn	5.2.2.2	O	
MLP-S-C-009	interval	5.2.2.2	O	
MLP-S-C-010	loc_type	5.2.2.2	O	
MLP-S-C-011	prio	5.2.2.2	O	
MLP-S-C-012	pushaddr	5.2.2.2	O	
MLP-S-C-013	req_id	5.2.2.2	O	
MLP-S-C-014	start_time	5.2.2.2	O	
MLP-S-C-015	stop_time	5.2.2.2	O	
MLP-S-C-016	duration	5.2.2.2	O	
MLP-S-C-017	url	5.2.2.2	O	
MLP-S-C-018	time_remaining	5.2.2.2	O	
MLP-S-C-019	les_ref	5.2.2.2	O	
MLP-S-C-020	supl_support_params	5.2.2.2	O	
MLP-S-C-021	Ip_address	5.2.2.2	O	

B.1.23 Support for Location Elements

Item	Function	Reference	Status	Requirement
MLP-T-C-001	Pos	5.2.2.3	M	
MLP-T-C-002	eme_pos	5.2.2.3	O	
MLP-T-C-003	trl_pos	5.2.2.3	O	
MLP-T-C-004	pd	5.2.2.3	M	
MLP-T-C-005	poserr	5.2.2.3	M	

Item	Function	Reference	Status	Requirement
MLP-T-C-022	MapData	5.2.2.3	O	
MLP-T-C-023	Base64Map	5.2.2.3	O	
MLP-T-C-024	Url	5.2.2.3	O	
MLP-T-C-025	MapRequest	5.2.2.3	O	
MLP-T-C-026	Width	5.2.2.3	O	
MLP-T-C-027	Height	5.2.2.3	O	
MLP-T-C-028	Zoom	5.2.2.3	O	
MLP-T-C-006	Time	5.2.2.3	M	
MLP-T-C-007	Alt	5.2.2.3	O	
MLP-T-C-008	Alt_unc	5.2.2.3	O	
MLP-T-C-020	civicloc	5.2.2.3	O	
MLP-T-C-021	civicloc_element	5.2.2.3	O	
MLP-T-C-009	qos_not_met	5.2.2.3	O	
MLP-T-C-010	direction	5.2.2.3	O	
MLP-T-C-011	speed	5.2.2.3	O	
MLP-T-C-012	lev_conf	5.2.2.3	O	
MLP-T-C-013	geo_info	5.2.2.3	O	
MLP-T-C-014	coordinateReferenceSystem	5.2.2.3	O	
MLP-T-C-015	identifier	5.2.2.3	O	
MLP-T-C-016	code	5.2.2.3	O	
MLP-T-C-017	codeSpace	5.2.2.3	O	
MLP-T-C-018	edition	5.2.2.3	O	
MLP-T-C-019	service_coverage	5.2.2.3	O	

B.1.24 Support for Result Elements

Item	Function	Reference	Status	Requirement
MLP-U-C-001	add_info	5.2.2.4	O	
MLP-U-C-002	result	5.2.2.4	M	

B.1.25 Support for Shape Elements

Item	Function	Reference	Status	Requirement
MLP-V-C-001	shape	5.2.2.5	M	MLP-V-C-002 OR MLP-V-C-003 OR MLP-V-C-004 OR MLP-V-C-005 OR MLP-V-C-006 OR MLP-V-C-007 OR MLP-V-C-008 OR MLP-V-C-009 OR MLP-V-C-010 OR MLP-V-C-011
MLP-V-C-002	Point	5.2.2.5	O	
MLP-V-C-003	LineString	5.2.2.5	O	
MLP-V-C-004	Box	5.2.2.5	O	
MLP-V-C-005	LinearRing	5.2.2.5	O	
MLP-V-C-006	Polygon	5.2.2.5	O	
MLP-V-C-007	CircularArcArea	5.2.2.5	O	
MLP-V-C-008	EllipticalArea	5.2.2.5	O	

Item	Function	Reference	Status	Requirement
MLP-V-C-009	MultiLineString	5.2.2.5	O	
MLP-V-C-010	MultiPoint	5.2.2.5	O	
MLP-V-C-011	MultiPolygon	5.2.2.5	O	

B.1.26 Support for Quality of Position Elements

Item	Function	Reference	Status	Requirement
MLP-W-C-001	eqop	5.2.2.6	O	
MLP-W-C-002	qop	5.2.2.6	O	
MLP-W-C-003	ll_acc	5.2.2.6	O	
MLP-W-C-004	hor_acc	5.2.2.6	O	
MLP-W-C-005	max_loc_age	5.2.2.6	O	
MLP-W-C-006	resp_req	5.2.2.6	O	
MLP-W-C-007	resp_timer	5.2.2.6	O	
MLP-W-C-008	alt_acc	5.2.2.6	O	

B.1.27 Support for GSM Network Parameters Elements

Item	Function	Reference	Status	Requirement
MLP-X-C-001	gsm_net_param	5.2.2.7	O	
MLP-X-C-002	cgi	5.2.2.7	O	
MLP-X-C-003	neid	5.2.2.7	O	MLP-X-C-004 OR MLP-X-C-005
MLP-X-C-004	vmscid	5.2.2.7	O	
MLP-X-S-005	vlrid	5.2.2.7	O	
MLP-X-C-006	nmr	5.2.2.7	O	
MLP-X-C-007	mcc	5.2.2.7	O	
MLP-X-C-008	mnc	5.2.2.7	O	
MLP-X-C-009	ndc	5.2.2.7	O	
MLP-X-C-010	cc	5.2.2.7	O	
MLP-X-C-011	vmscno	5.2.2.7	O	
MLP-X-C-012	vlrno	5.2.2.7	O	
MLP-X-C-013	lac	5.2.2.7	O	
MLP-X-C-014	cellid	5.2.2.7	O	
MLP-X-C-015	ta	5.2.2.7	O	
MLP-X-C-016	lmsi	5.2.2.7	O	
MLP-X-C-017	imsi	5.2.2.7	O	

B.1.28 Support for Context Elements

Item	Function	Reference	Status	Requirement
MLP-Y-C-001	client	5.2.2.8	M	
MLP-Y-C-002	sessionid	5.2.2.8	O	
MLP-Y-C-003	id	5.2.2.8	M	
MLP-Y-C-004	requestor	5.2.2.8	O	

Item	Function	Reference	Status	Requirement
MLP-Y-C-005	pwd	5.2.2.8	O	
MLP-Y-C-006	serviceid	5.2.2.8	O	
MLP-Y-C-007	requestmode	5.2.2.8	O	
MLP-Y-C-008	subclient	5.2.2.8	O	

B.1.29 Service attributes

Item	Function	Reference	Status	Requirement
MLP-Z-C-001	res_type	5.3.75	O	
MLP-Z-C-002	ver	5.3.75	M	

B.1.30 Transport mechanisms

Item	Function	Reference	Status	Requirement
MLP-AA-C-001	Support of HTTP mapping	5.2.1, 5.6	M	
MLP-AA-C-002	Support of port 9210	5.6	O	
MLP-AA-C-003	Support of port 9211	5.6	O	
MLP-AA-C-004	Support of transfer over other port	5.6	O	

B.1.31 Services

Item	Function	Reference	Status	Requirement
MLP-AB-C-001	Standard Location Immediate Service	5.2.3.2	M	MLP-A-C-003 AND MLP-B-C-003 AND MLP-B-C-004
MLP-AB-C-002	Emergency Location Immediate Service	5.2.3.3	O	MLP-A-C-004 AND MLP-B-C-007
MLP-AB-C-003	Standard Location Reporting Service	5.2.3.4	O	MLP-B-C-005 AND MLP-B-C-006
MLP-AB-C-004	Emergency Location Reporting Service	5.2.3.5	O	MLP-B-C-009
MLP-AB-C-005	Triggered Location Reporting Service	5.2.3.6	O	MLP-A-C-005 AND MLP-A-C-006 AND MLP-B-C-010 AND MLP-B-C-011 AND MLP-B-C-012
MLP-AB-C-006	Historic Location Immediate Service	5.2.3.6	O	MLP-A-C-008 AND MLP-B-C-014

B.2 SCR for Server

B.2.1 Service Initiation DTD

Item	Function	Reference	Status	Requirement
MLP-A-S-001	Service Initiation	5.6.2.1	M	MLP-A-S-002 AND MLP-A-S-003
MLP-A-S-002	Header	5.6.2.1	M	

Item	Function	Reference	Status	Requirement
MLP-A-S-003	Standard Location Immediate Request	5.6.2.1	M	MLP-B-S-003 AND MLP-B-S-004
MLP-A-S-004	Emergency Location Immediate Request	5.6.2.1	O	MLP-B-S-007
MLP-A-S-005	Triggered Location Reporting Request	5.6.2.1	O	MLP-B-S-010 AND MLP-B-S-011 AND MLP-B-S-012
MLP-A-S-006	Triggered Location Reporting Stop Request	5.6.2.1	O	MLP-B-S-012
MLP-A-S-008	Historic Location Immediate Request	5.6.2.1	O	MLP-B-S-014
MLP-A-S-007	Extension Message	5.6.2.1	O	

B.2.2 Service Result DTD

Item	Function	Reference	Status	Requirement
MLP-B-S-001	Service Result	5.6.2.2	M	MLP-B-S-002 AND MLP-B-S-003 AND MLP-B-S-004 AND MLP-B-S-005
MLP-B-S-002	Header	5.6.2.2	O	
MLP-B-S-003	Standard Location Immediate Answer	5.6.2.2	M	
MLP-B-S-004	Standard Location Immediate Report	5.6.2.2	O	
MLP-B-S-005	Standard Location Report	5.6.2.2	O	
MLP-B-S-006	Standard Location Report Answer	5.6.2.2	O	
MLP-B-S-007	Emergency Location Immediate Answer	5.6.2.2	O	
MLP-B-S-008	Emergency Location Immediate Report	5.6.2.2	O	MLP-B-S-007
MLP-B-S-009	Emergency Location Report	5.6.2.2	O	
MLP-B-S-010	Triggered Location Reporting Answer	5.6.2.2	O	MLP-B-S-011
MLP-B-S-011	Triggered Location Report	5.6.2.2	O	MLP-B-S-010
MLP-B-S-012	Triggered Location Reporting Stop Answer	5.6.2.2	O	
MLP-B-S-014	Historic Location Immediate Answer	5.6.2.2	O	
MLP-B-S-015	Historic Location Immediate Report	5.6.2.2	O	
MLP-B-S-013	Extension Message	5.6.2.2	O	

B.2.3 Header

Item	Function	Reference	Status	Requirement
------	----------	-----------	--------	-------------

Item	Function	Reference	Status	Requirement
MLP-C-S-001	client	5.2.3.1	M	
MLP-C-S-002	sessionid	5.2.3.1	O	
MLP-C-S-003	subclient	5.2.3.1	O	
MLP-C-S-004	requestor	5.2.3.1	O	

B.2.4 Standard Location Immediate Request

Item	Function	Reference	Status	Requirement
MLP-D-S-001	msids	5.2.3.2.1	O	
MLP-D-S-002	msid	5.2.3.2.1	M	
MLP-D-S-003	codeword	5.2.3.2.1	O	
MLP-D-S-004	gsm_net_param	5.2.3.2.1	O	
MLP-D-S-005	trans_id	5.2.3.2.1	O	
MLP-D-S-006	eqop	5.2.3.2.1	O	
MLP-D-S-007	geo_info	5.2.3.2.1	O	
MLP-D-S-008	loc_type	5.2.3.2.1	O	
MLP-D-S-009	prio	5.2.3.2.1	O	
MLP-D-S-010	pushaddr	5.2.3.2.1	O	
MLP-D-S-011	service_coverage	5.2.3.2.1	O	
MLP-D-S-013	MapRequest	5.2.2.10.1	O	
MLP-D-S-012	extension parameter	5.2.3.2.1	O	

B.2.5 Standard Location Immediate Answer

Item	Function	Reference	Status	Requirement
MLP-E-S-001	pos	5.2.3.2.2	M	
MLP-E-S-002	req_id	5.2.3.2.2	O	
MLP-E-S-003	result	5.2.3.2.2	M	
MLP-E-S-004	add_info	5.2.3.2.2	O	
MLP-E-S-005	extension parameter	5.2.3.2.2	O	

B.2.6 Standard Location Immediate Report

Item	Function	Reference	Status	Requirement
MLP-F-S-001	req_id	5.2.3.2.3	M	MLP-E-S-002
MLP-F-S-002	pos	5.2.3.2.3	M	
MLP-F-S-003	extension parameter	5.2.3.2.3	O	

B.2.7 Emergency Location Immediate Request

Item	Function	Reference	Status	Requirement
MLP-G-S-001	msids	5.2.3.3.1	O	
MLP-G-S-002	msid	5.2.3.3.1	M	
MLP-G-S-003	gsm_net_param	5.2.3.3.1	O	
MLP-G-S-004	trans_id	5.2.3.3.1	O	

Item	Function	Reference	Status	Requirement
MLP-G-S-005	esrd	5.2.3.3.1	O	
MLP-G-S-006	esrk	5.2.3.3.1	O	
MLP-G-S-007	eqop	5.2.3.3.1	O	
MLP-G-S-008	geo_info	5.2.3.3.1	O	
MLP-G-S-009	loc_type	5.2.3.3.1	O	
MLP-G-S-010	pushaddr	5.2.3.3.1	O	
MLP-G-S-012	supl_support_params	5.2.3.3.1	O	
MLP-G-S-013	MapRequest	5.2.2.11.1	O	
MLP-G-S-011	extension parameter	5.2.3.3.1	O	

B.2.8 Emergency Location Immediate Answer

Item	Function	Reference	Status	Requirement
MLP-H-S-001	eme_pos	5.2.3.3.2	M	
MLP-H-S-002	req_id	5.2.3.3.2	O	
MLP-H-S-003	result	5.2.3.3.2	M	
MLP-H-S-004	add_info	5.2.3.3.2	O	
MLP-H-S-005	extension parameter	5.2.3.3.2	O	

B.2.9 Emergency Location Immediate Report

Item	Function	Reference	Status	Requirement
MLP-I-S-001	req_id	5.2.3.3.3	M	MLP-H-S-002
MLP-I-S-002	eme_pos	5.2.3.3.3	M	
MLP-I-S-003	result	5.2.3.3.3	M	
MLP-I-S-004	add_info	5.2.3.3.3	O	
MLP-I-S-005	extension parameter	5.2.3.3.3	O	

B.2.10 Standard Location Report

Item	Function	Reference	Status	Requirement
MLP-J-S-001	pos	5.2.3.4.1	M	
MLP-J-S-002	extension parameter	5.2.3.4.1	O	

B.2.11 Standard Location Report Answer

Item	Function	Reference	Status	Requirement
MLP-K-S-001	result	5.2.3.4.2	M	
MLP-K-S-002	add_info	5.2.3.4.2	O	
MLP-K-S-003	extension parameter	5.2.3.4.2	O	

B.2.12 Emergency Location Report

Item	Function	Reference	Status	Requirement
------	----------	-----------	--------	-------------

Item	Function	Reference	Status	Requirement
MLP-L-S-001	eme_event	5.2.3.5.1	M	
MLP-L-S-002	extension parameter	5.2.3.5.1	O	

B.2.13 Triggered Location Reporting Request

Item	Function	Reference	Status	Requirement
MLP-M-S-001	msids	5.2.3.6.1	M	
MLP-M-S-002	interval	5.2.3.6.1	O	
MLP-M-S-003	start_time	5.2.3.6.1	O	
MLP-M-S-004	stop_time	5.2.3.6.1	O	
MLP-M-S-005	duration	5.2.3.6.1	O	
MLP-M-S-006	tlrr_event	5.2.3.6.1	O	
MLP-M-S-007	qop	5.2.3.6.1	O	
MLP-M-S-008	geo_info	5.2.3.6.1	O	
MLP-M-S-009	pushaddr	5.2.3.6.1	O	
MLP-M-S-010	loc_type	5.2.3.6.1	O	
MLP-M-S-011	prio	5.2.3.6.1	O	
MLP-M-S-012	service_coverage	5.2.3.6.1	O	
MLP-M-S-013	MapRequest	5.2.2.14.1	O	
MLP-M-S-013	extension parameter	5.2.3.6.1	O	

B.2.14 Triggered Location Reporting Answer

Item	Function	Reference	Status	Requirement
MLP-N-S-001	req_id	5.2.3.6.2	M	
MLP-N-S-002	result	5.2.3.6.2	M	
MLP-N-S-003	add_info	5.2.3.6.2	O	
MLP-N-S-004	extension parameter	5.2.3.6.2	O	
MLP-N-S-005	lcs_ref	5.2.3.6.2	O	

B.2.15 Triggered Location Report

Item	Function	Reference	Status	Requirement
MLP-O-S-001	req_id	5.2.3.6.3	M	
MLP-O-S-002	trl_pos	5.2.3.6.3	M	
MLP-O-S-003	time_remaining	5.2.3.6.3	O	
MLP-O-S-004	extension parameter	5.2.3.6.3	O	
MLP-O-S-005	lcs_ref	5.2.3.6.3	O	

B.2.16 Triggered Location Reporting Stop Request

Item	Function	Reference	Status	Requirement
MLP-P-S-001	req_id	5.2.3.6.4	M	
MLP-P-S-002	msids	5.2.3.6.4	O	
MLP-P-S-003	extension parameter	5.2.3.6.4	O	

Item	Function	Reference	Status	Requirement
MLP-P-S-004	lcs_ref	5.2.3.6.4	O	

B.2.17 Triggered Location Reporting Stop Answer

Item	Function	Reference	Status	Requirement
MLP-Q-S-001	req_id	5.2.3.6.5	M	
MLP-Q-S-002	msids	5.2.3.6.5	O	
MLP-Q-S-003	result	5.2.3.6.5	M	
MLP-Q-S-004	add_info	5.2.3.6.5	O	
MLP-Q-S-005	extension parameter	5.2.3.6.5	O	

B.2.18 Historic Location Immediate Request

Item	Function	Reference	Status	Requirement
MLP-AC-S-002	msid	5.2.3.8.1	M	
MLP-AC-S-005	trans_id	5.2.3.8.1	O	
MLP-AC-S-005	start_time	5.2.3.8.1	O	
MLP-AC-S-005	stop_time	5.2.3.8.1	O	
MLP-AC-S-005	interval	5.2.3.8.1	O	
MLP-AC-S-005	qop	5.2.3.8.1	O	
MLP-AC-S-005	geo_info	5.2.3.8.1	O	
MLP-AC-S-010	pushaddr	5.2.3.8.1	O	
MLP-AC-S-009	prio	5.2.3.8.1	O	
MLP-AC-S-012	extension parameter	5.2.3.8.1	O	

B.2.19 Historic Location Immediate Answer

Item	Function	Reference	Status	Requirement
MLP-AD-S-001	pos	5.2.3.8.2	M	
MLP-AD-S-002	req_id	5.2.3.8.2	O	
MLP-AD-S-003	result	5.2.3.8.2	M	
MLP-AD-S-004	add_info	5.2.3.8.2	O	
MLP-AD-S-005	extension parameter	5.2.3.8.2	O	

B.2.20 Historic Location Immediate Report

Item	Function	Reference	Status	Requirement
MLP-AE-S-001	req_id	5.2.3.8.3	M	
MLP-AE-S-002	pos	5.2.3.8.3	M	
MLP-AE-S-003	extension parameter	5.2.3.8.3	O	

B.2.21 Support for Identity Elements

Item	Function	Reference	Status	Requirement
------	----------	-----------	--------	-------------

Item	Function	Reference	Status	Requirement
MLP-R-S-001	msid	5.2.2.1	M	
MLP-R-S-002	msid_range	5.2.2.1	O	
MLP-R-S-003	msids	5.2.2.1	O	
MLP-R-S-004	codeword	5.2.2.1	O	
MLP-R-S-005	esrd	5.2.2.1	O	
MLP-R-S-006	esrk	5.2.2.1	O	
MLP-R-S-007	session	5.2.2.1	O	
MLP-R-S-008	start_msid	5.2.2.1	O	
MLP-R-S-009	stop_msid	5.2.2.1	O	
MLP-R-S-010	trans_id	5.2.2.1	O	

B.2.22 Support for Function Elements

Item	Function	Reference	Status	Requirement
MLP-S-S-001	eme_event	5.2.2.2	O	
MLP-S-S-002	tlrr_event	5.2.2.2	O	
MLP-S-S-003	ms_action	5.2.2.2	O	
MLP-S-S-004	change_area	5.2.2.2	O	
MLP-S-S-005	target_area	5.2.2.2	O	
MLP-S-S-006	no_of_reports	5.2.2.2	O	
MLP-S-S-007	name_area	5.2.2.2	O	
MLP-S-S-008	plmn	5.2.2.2	O	
MLP-S-S-009	interval	5.2.2.2	O	
MLP-S-S-010	loc_type	5.2.2.2	O	
MLP-S-S-011	prio	5.2.2.2	O	
MLP-S-S-012	pushaddr	5.2.2.2	O	
MLP-S-S-013	req_id	5.2.2.2	O	
MLP-S-S-014	start_time	5.2.2.2	O	
MLP-S-S-015	stop_time	5.2.2.2	O	
MLP-S-S-016	duration	5.2.2.2	O	
MLP-S-S-017	url	5.2.2.2	O	
MLP-S-S-018	time_remaining	5.2.2.2	O	
MLP-S-S-019	les_ref	5.2.2.2	O	
MLP-S-S-020	supl_support_params	5.2.2.2	O	
MLP-S-S-021	ip_address	5.2.2.2	O	

B.2.23 Support for Location Elements

Item	Function	Reference	Status	Requirement
MLP-T-S-001	pos	5.2.2.3	M	
MLP-T-S-002	eme_pos	5.2.2.3	O	
MLP-T-S-003	trl_pos	5.2.2.3	O	
MLP-T-S-004	pd	5.2.2.3	M	
MLP-T-S-005	poserr	5.2.2.3	M	
MLP-T-S-022	MapData	5.2.2.3	O	

Item	Function	Reference	Status	Requirement
MLP-T-S-023	Base64Map	5.2.2.3	O	
MLP-T-S-024	Url	5.2.2.3	O	
MLP-T-S-025	MapRequest	5.2.2.3	O	
MLP-T-S-026	Width	5.2.2.3	O	
MLP-T-S-027	Height	5.2.2.3	O	
MLP-T-S-028	Zoom	5.2.2.3	O	
MLP-T-S-006	time	5.2.2.3	M	
MLP-T-S-007	alt	5.2.2.3	O	
MLP-T-S-008	alt_unc	5.2.2.3	O	
MLP-T-S-020	civicloc	5.2.2.3	O	
MLP-T-S-021	civicloc_element	5.2.2.3	O	
MLP-T-S-009	qos_not_met	5.2.2.3	O	
MLP-T-S-010	direction	5.2.2.3	O	
MLP-T-S-011	speed	5.2.2.3	O	
MLP-T-S-012	lev_conf	5.2.2.3	O	
MLP-T-S-013	geo_info	5.2.2.3	O	
MLP-T-S-014	coordinateReferenceSystem	5.2.2.3	O	
MLP-T-S-015	identifier	5.2.2.3	O	
MLP-T-S-016	code	5.2.2.3	O	
MLP-T-S-017	codeSpace	5.2.2.3	O	
MLP-T-S-018	edition	5.2.2.3	O	
MLP-T-S-019	service_coverage	5.2.2.3	O	

B.2.24 Support for Result Elements

Item	Function	Reference	Status	Requirement
MLP-U-S-001	add_info	5.2.2.4	O	
MLP-U-S-002	result	5.2.2.4	M	

B.2.25 Support for Shape Elements

Item	Function	Reference	Status	Requirement
MLP-V-S-001	shape	5.2.2.5	M	MLP-V-S-002 OR MLP-V-S-003 OR MLP-V-S-004 OR MLP-V-S-005 OR MLP-V-S-006 OR MLP-V-S-007 OR MLP-V-S-008 OR MLP-V-S-009 OR MLP-V-S-010 OR MLP-V-S-011
MLP-V-S-002	Point	5.2.2.5	O	
MLP-V-S-003	LineString	5.2.2.5	O	
MLP-V-S-004	Box	5.2.2.5	O	
MLP-V-S-005	LinearRing	5.2.2.5	O	
MLP-V-S-006	Polygon	5.2.2.5	O	
MLP-V-S-007	CircularArcArea	5.2.2.5	O	
MLP-V-S-008	EllipticalArea	5.2.2.5	O	
MLP-V-S-009	MultiLineString	5.2.2.5	O	

Item	Function	Reference	Status	Requirement
MLP-V-S-010	MultiPoint	5.2.2.5	O	
MLP-V-S-011	MultiPolygon	5.2.2.5	O	

B.2.26 Support for Quality of Position Elements

Item	Function	Reference	Status	Requirement
MLP-W-S-001	eqop	5.2.2.6	O	
MLP-W-S-002	qop	5.2.2.6	O	
MLP-W-S-003	ll_acc	5.2.2.6	O	
MLP-W-S-004	hor_acc	5.2.2.6	O	
MLP-W-S-005	max_loc_age	5.2.2.6	O	
MLP-W-S-006	resp_req	5.2.2.6	O	
MLP-W-S-007	resp_timer	5.2.2.6	O	
MLP-W-S-008	alt_acc	5.2.2.6	O	

B.2.27 Support for Network Parameters Elements

Item	Function	Reference	Status	Requirement
MLP-X-S-001	gsm_net_param	5.2.2.7	O	
MLP-X-S-002	cgi	5.2.2.7	O	
MLP-X-S-003	neid	5.2.2.7	O	MLP-X-S-004 OR MLP-X-S-005
MLP-X-S-004	vmscid	5.2.2.7	O	
MLP-X-S-005	vlrid	5.2.2.7	O	
MLP-X-S-006	nmr	5.2.2.7	O	
MLP-X-S-007	mcc	5.2.2.7	O	
MLP-X-S-008	mnc	5.2.2.7	O	
MLP-X-S-009	ndc	5.2.2.7	O	
MLP-X-S-010	cc	5.2.2.7	O	
MLP-X-S-011	vmscno	5.2.2.7	O	
MLP-X-S-012	vlrno	5.2.2.7	O	
MLP-X-S-013	lac	5.2.2.7	O	
MLP-X-S-014	cellid	5.2.2.7	O	
MLP-X-S-015	ta	5.2.2.7	O	
MLP-X-S-016	lmsi	5.2.2.7	O	
MLP-X-S-017	imsi	5.2.2.7	O	

B.2.28 Support for Context Elements

Item	Function	Reference	Status	Requirement
MLP-Y-S-001	client	5.2.2.8	M	
MLP-Y-S-002	sessionid	5.2.2.8	O	
MLP-Y-S-003	id	5.2.2.8	O	
MLP-Y-S-004	requestor	5.2.2.8	O	
MLP-Y-S-005	pwd	5.2.2.8	O	

Item	Function	Reference	Status	Requirement
MLP-Y-S-006	serviceid	5.2.2.8	O	
MLP-Y-S-007	requestmode	5.2.2.8	O	
MLP-Y-S-008	subclient	5.2.2.8	O	

B.2.29 Service attributes

Item	Function	Reference	Status	Requirement
MLP-Z-S-001	res_type	5.3.75	M	
MLP-Z-S-002	ver	5.3.75	M	

B.2.30 Transport mechanisms

Item	Function	Reference	Status	Requirement
MLP-AA-S-001	Support of HTTP mapping	5.2.1, 5.6	M	
MLP-AA-S-002	Support of port 9210	5.6	O	
MLP-AA-S-003	Support of port 9211	5.6	O	
MLP-AA-S-004	Support of transfer over other port	5.6	O	

B.2.31 Services

Item	Function	Reference	Status	Requirement
MLP-AB-S-001	Standard Location Immediate Service	5.2.3.2	M	MLP-A-S-003 AND MLP-B-S-003
MLP-AB-S-002	Emergency Location Immediate Service	5.2.3.3	O	MLP-A-S-004 AND MLP-B-S-004
MLP-AB-S-003	Standard Location Reporting Service	5.2.3.4	O	MLP-B-S-005 AND MLP-B-S-006
MLP-AB-S-004	Emergency Location Reporting Service	5.2.3.5	O	MLP-B-S-009
MLP-AB-S-005	Triggered Location Reporting Service	5.2.3.6	O	MLP-A-S-005 AND MLP-A-S-006 AND MLP-B-S-010 AND MLP-B-S-011 AND MLP-B-S-012
MLP-AB-S-006	Historic Location Immediate Service	5.2.3.6	O	MLP-A-S-008 AND MLP-B-S-014