



OMA PoC Control Plane

Candidate Version 2.0 – 07 May 2008

Open Mobile Alliance
OMA-TS-PoC_ControlPlane-V2_0-20080507-C

Use of this document is subject to all of the terms and conditions of the Use Agreement located at <http://www.openmobilealliance.org/UseAgreement.html>.

Unless this document is clearly designated as an approved specification, this document is a work in process, is not an approved Open Mobile Alliance™ specification, and is subject to revision or removal without notice.

You may use this document or any part of the document for internal or educational purposes only, provided you do not modify, edit or take out of context the information in this document in any manner. Information contained in this document may be used, at your sole risk, for any purposes. You may not use this document in any other manner without the prior written permission of the Open Mobile Alliance. The Open Mobile Alliance authorizes you to copy this document, provided that you retain all copyright and other proprietary notices contained in the original materials on any copies of the materials and that you comply strictly with these terms. This copyright permission does not constitute an endorsement of the products or services. The Open Mobile Alliance assumes no responsibility for errors or omissions in this document.

Each Open Mobile Alliance member has agreed to use reasonable endeavors to inform the Open Mobile Alliance in a timely manner of Essential IPR as it becomes aware that the Essential IPR is related to the prepared or published specification. However, the members do not have an obligation to conduct IPR searches. The declared Essential IPR is publicly available to members and non-members of the Open Mobile Alliance and may be found on the “OMA IPR Declarations” list at <http://www.openmobilealliance.org/ipr.html>. The Open Mobile Alliance has not conducted an independent IPR review of this document and the information contained herein, and makes no representations or warranties regarding third party IPR, including without limitation patents, copyrights or trade secret rights. This document may contain inventions for which you must obtain licenses from third parties before making, using or selling the inventions. Defined terms above are set forth in the schedule to the Open Mobile Alliance Application Form.

NO REPRESENTATIONS OR WARRANTIES (WHETHER EXPRESS OR IMPLIED) ARE MADE BY THE OPEN MOBILE ALLIANCE OR ANY OPEN MOBILE ALLIANCE MEMBER OR ITS AFFILIATES REGARDING ANY OF THE IPR'S REPRESENTED ON THE “OMA IPR DECLARATIONS” LIST, INCLUDING, BUT NOT LIMITED TO THE ACCURACY, COMPLETENESS, VALIDITY OR RELEVANCE OF THE INFORMATION OR WHETHER OR NOT SUCH RIGHTS ARE ESSENTIAL OR NON-ESSENTIAL.

THE OPEN MOBILE ALLIANCE IS NOT LIABLE FOR AND HEREBY DISCLAIMS ANY DIRECT, INDIRECT, PUNITIVE, SPECIAL, INCIDENTAL, CONSEQUENTIAL, OR EXEMPLARY DAMAGES ARISING OUT OF OR IN CONNECTION WITH THE USE OF DOCUMENTS AND THE INFORMATION CONTAINED IN THE DOCUMENTS.

© 2008 Open Mobile Alliance Ltd. All Rights Reserved.

Used with the permission of the Open Mobile Alliance Ltd. under the terms set forth above.

Contents

1.	SCOPE	3
2.	REFERENCES	3
2.1	NORMATIVE REFERENCES	3
2.2	INFORMATIVE REFERENCES	3
3.	TERMINOLOGY AND CONVENTIONS	3
3.1	CONVENTIONS	3
3.2	DEFINITIONS	3
3.3	ABBREVIATIONS	3
4.	INTRODUCTION	3
5.	COMMON PROCEDURES	3
5.1	GENERAL	3
5.2	AUTHENTICATED ORIGINATOR'S PoC ADDRESS	3
5.3	SIGNALING COMPRESSION	3
5.4	NICK NAME	3
5.5	ERROR HANDLING	3
5.6	WARNING HEADER	3
5.6.1	General	3
5.6.2	Warning texts	3
5.6.3	Warning text code numbers	3
5.7	PoC SESSION IDENTITY	3
5.7A	PoC SESSION ASSOCIATION	3
5.8	QoE PROFILES	3
5.8.1	General	3
5.8.2	The 'Official Government Use' QoE Profile	3
5.8.3	Priority and pre-emption	3
5.9	ANONYMOUS PoC ADDRESS	3
5.10	PoC SPEECH	3
5.11	IMPLICIT MEDIA BURST REQUEST	3
5.12	STAY ON THE MEDIA PATH	3
6.	PROCEDURES AT THE PoC CLIENT	3
6.1	PoC CLIENT ORIGINATING PROCEDURES	3
6.1a	Backward compatibility	3
6.1.1	PoC service registration	3
6.1.1.1	PoC service registration and re-registration	3
6.1.1.2	PoC service de-registration	3
6.1.2	PoC Service Settings procedure	3
6.1.3	PoC Session initiation	3
6.1.3.1	General	3
6.1.3.1a	SDP offer generation	3
6.1.3.2	Using Pre-established Session	3
6.1.3.2.1	PoC Client initiates a Pre-established Session	3
6.1.3.2.2	PoC Client initiates an Ad-hoc PoC Group Session and 1-1 PoC Session	3
6.1.3.2.3	PoC Client initiates a Pre-arranged PoC Group Session or joins a Chat PoC Group Session	3
6.1.3.2.3.1	Dispatch PoC Session initiation as PoC Dispatcher	3
6.1.3.2.4	PoC Client releases a Pre-established Session	3
6.1.3.3	Establishment of an On-demand Session	3
6.1.3.3.1	PoC Client initiates an Ad-hoc PoC Group Session and 1-1 PoC Session	3
6.1.3.3.2	PoC Client initiates a Pre-arranged PoC Group Session or joins a Chat PoC Group Session	3
6.1.3.3.2.1	Dispatch PoC Session initiation as PoC Dispatcher	3
6.1.4	PoC Client PoC Session modification	3
6.1.4.1	General	3
6.1.4.2	PoC Client placing media on hold	3
6.1.4.3	PoC Client placing media off hold	3

- 6.1.4.4 User Plane adaptation3
- 6.1.4.5 SIP Session refresh.....3
- 6.1.4.6 Adding and disconnecting from Media Stream.....3
- 6.1.4.7 Enabling and disabling the Discrete Media Transfer Progress Report and the Final Report3
- 6.1.4.8 PoC Client modifies the Pre-established Session3
- 6.1.5 PoC Client rejoining a PoC Session.....3
 - 6.1.5.1 On-demand Session establishment.....3
 - 6.1.5.2 Pre-established Session3
- 6.1.6 PoC Client leaving a PoC Session3
 - 6.1.6.1 Leaving a PoC Session - On-demand Session case3
 - 6.1.6.2 Leaving a PoC Session – Pre-established Session case3
- 6.1.7 PoC Client adding PoC User(s) to a PoC Session.....3
- 6.1.8 PoC Client sending an Instant Personal Alert3
- 6.1.9 PoC Client sending a Group Advertisement3
- 6.1.10 PoC Client subscription to the conference state event package3
- 6.1.11 PoC Client canceling a PoC Session.....3
 - 6.1.11.1 Canceling a PoC Session - On-demand Session case3
- 6.1.12 Simultaneous PoC Session control procedures3
 - 6.1.12.1 PoC Client setting PoC Session priority.....3
 - 6.1.12.2 PoC Client handling of PoC Session locking3
- 6.1.13 PoC Client expels Participant(s) from a PoC Session.....3
- 6.1.14 PoC Dispatcher transferring the PoC Dispatcher role.....3
- 6.1.15 PoC Client sending a Discrete Media as a SIP MESSAGE3
- 6.1.16 PoC Client releases a PoC Session3
 - 6.1.16.1 Releasing a PoC Session – On-demand Session case3
 - 6.1.16.2 Releasing a PoC Session – Pre-established Session case.....3
- 6.1.17 PoC Client sending an FDCFO Proceed SIP MESSAGE.....3
- 6.2 PO C CLIENT TERMINATION PROCEDURES3**
 - 6.2.1 PoC Client invited to a PoC Session.....3
 - 6.2.1.1 General3
 - 6.2.1.1a SDP answer generation.....3
 - 6.2.1.2 Auto-answer case3
 - 6.2.1.3 Manual-answer case3
 - 6.2.2 PoC Client receiving a PoC Session modification request.....3
 - 6.2.2.1 General3
 - 6.2.2.2 PoC Client receiving a request for User plane adaptation3
 - 6.2.2.3 PoC Client receiving a request to add and disconnect Media Streams.....3
 - 6.2.3 PoC Client receiving a PoC Session release request.....3
 - 6.2.3.1 PoC Session release request – On-demand Session case3
 - 6.2.3.2 PoC Session release request – Pre-established Session case3
 - 6.2.4 PoC Client receiving an Instant Personal Alert.....3
 - 6.2.5 PoC Client receiving a Group Advertisement.....3
 - 6.2.6 PoC Client receiving a PoC Session SIP CANCEL request3
 - 6.2.6.1 PoC Session SIP CANCEL request - On-demand Session case.....3
 - 6.2.7 Simultaneous PoC Session control procedures3
 - 6.2.8 PoC Client receiving Discrete Media as a SIP MESSAGE3
 - 6.2.9 PoC Client receiving an FDCFO Proceed SIP MESSAGE3
 - 6.2.10 PoC Client receiving capability query3
- 7. PROCEDURES AT THE POC SERVER3**
 - 7.1 DETERMINATION OF POC SERVER ROLE3**
 - 7.1.1 Reception of an initial SIP INVITE request.....3
 - 7.1.2 Reception of a SIP REFER request.....3
 - 7.1.3 Reception of a SIP MESSAGE request3
 - 7.1.4 Reception of a SIP SUBSCRIBE request3
 - 7.1.5 Reception of a SIP OPTIONS request3
 - 7.1.6 Reception of a SIP REGISTER request.....3
 - 7.2 CONTROLLING POC FUNCTION PROCEDURES3**
 - 7.2.1 Request terminating at the Controlling PoC Function3
 - 7.2.1.1 General3

7.2.1.1a	SDP answer generation	3
7.2.1.1b	PoC Session setup request	3
7.2.1.2	<i>Ad-hoc PoC Group and 1-1 PoC Session setup request</i>	3
7.2.1.3	<i>Pre-arranged PoC Group Session setup request</i>	3
7.2.1.3.1	General	3
7.2.1.3.2	Dispatch PoC Session setup request from PoC Dispatcher	3
7.2.1.3.3	Dispatch PoC Session setup request from PoC Fleet Member	3
7.2.1.4	<i>Rejoining PoC Session request</i>	3
7.2.1.5	<i>Joining Chat PoC Group Session request</i>	3
7.2.1.6	<i>PoC Session joining policy</i>	3
7.2.1.7	<i>PoC Session modification</i>	3
7.2.1.8	<i>Adding Participants to PoC Session request</i>	3
7.2.1.9	<i>Leaving PoC Session request</i>	3
7.2.1.9.1	SIP BYE request received in a PoC Session	3
7.2.1.9.2	SIP REFER BYE request received when using a Pre-established Session	3
7.2.1.9.3	SIP BYE request received within a Pre-established Session	3
7.2.1.9.4	SIP REFER BYE request received when using an On-demand Session	3
7.2.1.10	<i>Cancel of PoC Session setup request</i>	3
7.2.1.11	<i>PoC Session Participant information request</i>	3
7.2.1.11.1	Subscribing to Participant information	3
7.2.1.11.2	Generating a SIP NOTIFY request	3
7.2.1.11.3	Terminating the subscription	3
7.2.1.12	<i>Group Advertisement request</i>	3
7.2.1.13	<i>SIP Session refresh procedure</i>	3
7.2.1.14	<i>PoC Session initiation policy</i>	3
7.2.1.14.1	Pre-arranged PoC Group Session initiation policy	3
7.2.1.14.2	Dispatch PoC Session initiation policy for PoC Dispatcher	3
7.2.1.14.3	Dispatch PoC Session initiation policy for PoC Fleet Member	3
7.2.1.15	<i>PoC Session adding policy</i>	3
7.2.1.16	<i>PoC Session release policy</i>	3
7.2.1.17	<i>Generating a SIP NOTIFY request to the SIP REFER request</i>	3
7.2.1.18	<i>PoC Session Participant information policy</i>	3
7.2.1.19	<i>PoC Session role transfer policy</i>	3
7.2.1.20	<i>Group Advertisement policy</i>	3
7.2.1.21	<i>Policy for allowing Media Streams in a PoC Session</i>	3
7.2.1.22	<i>Removing Media Streams from a PoC Session policy</i>	3
7.2.1.23	<i>Discrete Media request</i>	3
7.2.1.24	<i>PoC Dispatcher role transfer request</i>	3
7.2.1.25	<i>FDCFO Proceed request</i>	3
7.2.1.26	<i>Querying for capabilities</i>	3
7.2.1.27	<i>PoC Session expulsion policy</i>	3
7.2.2	Request initiated by the Controlling PoC Function	3
7.2.2a	Backward compatibility	3
7.2.2.1	General	3
7.2.2.1a	SDP offer generation	3
7.2.2.2	<i>PoC Session invitation requests</i>	3
7.2.2.3	<i>Cancel of PoC Session invitation requests</i>	3
7.2.2.4	<i>Removal of Participant from PoC Session</i>	3
7.2.2.5	<i>PoC Session modification</i>	3
7.2.2.6	<i>Group Advertisement request</i>	3
7.2.2.7	<i>Discrete Media request</i>	3
7.2.2.8	<i>FDCFO Proceed request</i>	3
7.3	PARTICIPATING PO C FUNCTION PROCEDURES	3
7.3.1	Requests initiated by the served PoC User	3
7.3.1a	Backward compatibility	3
7.3.1.1	General	3
7.3.1.1a	SDP offer generation in case of On-demand session	3
7.3.1.1b	SDP offer generation in case of Pre-established Session	3
7.3.1.1c	SDP answer generation	3
7.3.1.2	<i>Pre-established Session</i>	3
7.3.1.3	<i>Pre-established Session modification</i>	3
7.3.1.4	<i>PoC Session establishment or rejoin using On-demand Session</i>	3
7.3.1.5	<i>PoC Session initiation using Pre-established Session</i>	3

7.3.1.6	PoC Session modifications	3
7.3.1.7	SIP SUBSCRIBE request	3
7.3.1.8	SIP REFER request received	3
7.3.1.9	SIP CANCEL request	3
7.3.1.10	SIP BYE request from PoC Client	3
7.3.1.10.1	SIP BYE request from PoC Client – On-demand Session case	3
7.3.1.10.2	SIP REFER BYE request from PoC Client – Pre-established Session case	3
7.3.1.10.3	Pre-established Session release request from PoC Client	3
7.3.1.11	Group Advertisement request	3
7.3.1.12	Simultaneous PoC Session control procedures	3
7.3.1.12.1	General	3
7.3.1.12.2	PoC Session priority request	3
7.3.1.12.3	PoC Session locking request	3
7.3.1.13	SIP Session timer expiry	3
7.3.1.14	PoC Service Setting procedure	3
7.3.1.15	PoC Session release from User Plane	3
7.3.1.16	Discrete Media request	3
7.3.1.17	FDCFO Proceed request	3
7.3.1.18	Querying for capabilities	3
7.3.2	Requests terminated by the served PoC User	3
7.3.2a	Backward compatibility	3
7.3.2.1	General	3
7.3.2.1a	SDP offer generation	3
7.3.2.1b	SDP answer generation in case of On-demand session	3
7.3.2.1c	SDP answer generation in case of Pre-established Session	3
7.3.2.2	PoC Session invitation request	3
7.3.2.2a	Automatic-answer	3
7.3.2.2b	Manual-answer	3
7.3.2.2.1	Automatic-answer using On-demand Session	3
7.3.2.2.2	Automatic-answer using Pre-established Session	3
7.3.2.2.3	Manual-answer using On-demand Session	3
7.3.2.2.4	Manual-answer using Pre-established Session	3
7.3.2.2.5	Forward invitation to a PoC Box	3
7.3.2.2.5.1	Determination of routing to a PoC Box upon an incoming invitation	3
7.3.2.2.5.2	Determination of routing to a NW PoC Box upon failure to receive a valid SIP 2xx response	3
7.3.2.2.5.3	Forward invitations to a NW PoC Box	3
7.3.2.2.5.4	Forward invitations to a UE PoC Box	3
7.3.2.3	PoC Session modifications	3
7.3.2.4	SIP NOTIFY request	3
7.3.2.5	SIP CANCEL request	3
7.3.2.6	SIP BYE request	3
7.3.2.6.1	SIP BYE request from the Controlling PoC Function – On-demand Session case	3
7.3.2.6.2	SIP BYE request from the Controlling PoC Function – Pre-established Session case	3
7.3.2.6.3	Leaving a PoC Session when using Pre-established Session	3
7.3.2.7	Group Advertisement request	3
7.3.2.8	Discrete Media request	3
7.3.2.9	FDCFO Proceed request	3
7.3.2.10	PoC Server Releases a PoC Session	3
7.3.2.11	Querying for capabilities	3
7.3.3	Requests initiated by the PoC Server performing the Participating PoC Function	3
7.3.3.1	Subscribing to Participant Information	3
7.4	HANDLING OF REQUESTS UNRELATED TO POC SESSIONS	3
7.4.1	Instant Personal Alert	3
7.4.1.1	Instant Personal Alert procedure at Originating PoC Server	3
7.4.1.2	Instant Personal Alert procedure at terminating PoC Server	3
7.4.2	Subscribing to the SIP Registration event	3
7.4.2.1	Reception of the SIP REGISTER request	3
7.4.2.2	Reception of the SIP NOTIFY request	3
7.5	ERROR HANDLING	3
7.5.1	Conference-factory URI does not exist	3
7.5.2	Conference URI does not exist	3
8.	POC BOX	3

- 8.1 COMMON PoC BOX PROCEDURES.....3**
 - 8.1.1 General.....3
 - 8.1.2 PoC Box SDP answer generation.....3
 - 8.1.3 PoC Box receiving a request for User plane adaptation.....3
 - 8.1.4 PoC Box receiving a request to add and disconnect Media Streams3
- 8.2 NW PoC BOX SPECIFIC PROCEDURES3**
 - 8.2.1 NW PoC Box invited to PoC Session3
 - 8.2.2 NW PoC Box PoC Session release request.....3
 - 8.2.3 NW PoC Box leaving a PoC Session - On-demand Session case.....3
 - 8.2.4 NW PoC Box receiving capability query3
 - 8.2.5 NW PoC Box receiving a request for User plane adaptation3
 - 8.2.6 NW PoC Box receiving a request to add and disconnect Media Streams.....3
 - 8.2.7 NW PoC Box receiving a Discrete Media in a SIP MESSAGE request.....3
- 8.3 UE PoC BOX SPECIFIC PROCEDURES.....3**
 - 8.3.1 UE PoC Box invited to a PoC Session.....3
 - 8.3.2 UE PoC Box PoC Session release request3
 - 8.3.3 UE PoC Box Leaving a PoC Session - On-demand Session case.....3
 - 8.3.4 UE PoC Box receiving capability query3
 - 8.3.5 UE PoC Box receiving a request for User plane adaptation3
 - 8.3.6 UE PoC Box receiving a request to add and disconnect Media Streams3
 - 8.3.7 UE PoC Box receiving a Discrete Media in a SIP MESSAGE request3
- APPENDIX A. STATIC CONFORMANCE REQUIREMENTS (SCR) (NORMATIVE)3**
 - A.1 GENERAL HIGH LEVEL EXTERNAL DEPENDENCIES (GEN)3**
 - A.1.1 PoC Client.....3
 - A.1.2 PoC Server3
 - A.2 PoC SERVICE REGISTRATION (REG)3**
 - A.2.1 PoC Client.....3
 - A.2.2 PoC Server3
 - A.3 PoC SESSION INITIATION, JOINING, RELEASE (SJR).....3**
 - A.3.1 PoC Client.....3
 - A.3.2 PoC Server3
 - A.4 PoC SESSION-RELATED FEATURES (SRF)3**
 - A.4.1 PoC Client.....3
 - A.4.2 PoC Server3
 - A.5 SESSION-UNRELATED FEATURES (SUF)3**
 - A.5.1 PoC Client.....3
 - A.5.2 PoC Server3
 - A.6 PoC BOX (PBO).....3**
 - A.6.1 UE PoC Box (client functionality).....3
 - A.6.2 NW PoC Box (server functionality).....3
 - A.6.3 PoC Server3
 - A.7 PoC DISPATCHER (DIS)3**
 - A.7.1 PoC Client.....3
 - A.7.2 PoC Server3
 - A.8 QUALITY OF EXPERIENCE (QOE)3**
 - A.8.1 PoC Client.....3
 - A.8.2 PoC Server3
 - A.9 FULL-DUPLEX FOLLOW ON CALL (FDC).....3**
 - A.9.1 PoC Client.....3
 - A.9.2 PoC Server3
 - A.10 MULTIPLE PoC GROUPS (MPG)3**
 - A.10.1 PoC Client.....3
 - A.10.2 PoC Server3
 - A.11 REQUEST WITH MEDIA CONTENT (RMC)3**
 - A.11.1 PoC Client.....3
 - A.11.2 PoC Server3
 - A.12 OPERATOR SPECIFIED WARNING MESSAGE (OWM)3**

- A.12.1 PoC Client.....3
- A.12.2 PoC Server3
- A.13 PoC MEDIA TRAFFIC OPTIMISATION (TOP)3**
 - A.13.1 PoC Client.....3
 - A.13.2 PoC Server3
- A.14 SIMULTANEOUS PoC SESSIONS (SPS).....3**
 - A.14.1 PoC Client.....3
 - A.14.2 PoC Server3
- A.15 INVITED PARTIES IDENTITY INFORMATION (IPI).....3**
 - A.15.1 PoC Client.....3
 - A.15.2 PoC Server3
- A.16 QUERYING FOR CAPABILITIES (CFC)3**
 - A.16.1 PoC Client.....3
 - A.16.2 UE PoC Box (client functionality).....3
 - A.16.3 NW PoC Box (server functionality).....3
 - A.16.4 PoC Server3
- APPENDIX B. THE PARAMETERS TO BE PROVISIONED FOR POC SERVICE (NORMATIVE).....3**
 - B.1 OMA PoC DEVICE MANAGEMENT GENERAL3**
 - B.2 OMA PoC APPLICATION CHARACTERISTICS FILE3**
 - B.3 OMA PoC DEVICE MANAGEMENT MANAGEMENT OBJECT (MO) FILE.....3**
 - B.3.1 OMA PoC Management Object tree.....3
 - B.3.2 Management Object parameters.....3
- APPENDIX C. PRESENCE INFORMATION ELEMENTS AND PROCEDURES (NORMATIVE).....3**
 - C.1 PoC SPECIFIC PRESENCE INFORMATION ELEMENTS OVERVIEW3**
 - C.1.1 Availability for PoC Session Service.....3
 - C.1.2 Availability for PoC Alert Service.....3
 - C.1.3 Willingness for PoC Session Service.....3
 - C.1.4 Willingness for PoC Alerts Service3
 - C.1.5 PoC Session Participation.....3
 - C.1.6 Automatic Answer Mode.....3
 - C.2 PoC SERVER PROCEDURES3**
 - C.2.1 Acting as a Presence Source3
 - C.2.1.1 PoC registration and de-registration.....3
 - C.2.1.2 Incoming PoC Session Barring (ISB)3
 - C.2.1.3 Incoming Instant Personal Alert Barring (IAB).....3
 - C.2.1.4 Automatic Answer-mode.....3
 - C.2.1.5 PoC Service Settings expiration or removal procedure3
 - C.2.2 Acting as watcher.....3
 - C.3 PoC CLIENT3**
 - C.4 PoC SPECIFIC PRESENCE VALUES3**
- APPENDIX D. INITIAL FILTER CRITERIA (INFORMATIVE)3**
 - D.1 GENERAL3**
 - D.2 ORIGINATING FILTER CRITERIA3**
 - D.3 TERMINATING FILTER CRITERIA3**
 - D.3.1 Terminating Filter Criteria for PoC Address when a PoC Client is registered3
 - D.3.2 Terminating Filter Criteria for PoC Address when no PoC Client is registered.....3
 - D.3.3 Terminating Filter Criteria for PoC Group Identity or PoC Session Identity3
- APPENDIX E. DOCUMENTATION OF SIP, SDP AND XML EXTENSIONS (INFORMATIVE)3**
 - E.1 PoC CONTENT TYPES.....3**
 - E.1.1 Group Advertisement.....3
 - E.1.2 Participant information indications.....3
 - E.1.2.1 Example of the participant information indications3
 - E.1.2.2 XML Schema for a participant information indications.....3
 - E.1.3 FDCFO Proceed document3
 - E.1.3.1 Structure of a FDCFO Proceed document.....3
 - E.1.3.2 Example of a FDCFO Proceed XML document.....3

- E.1.3.3 XML Schema for a FDCFO Proceed XML document3
- E.2 PoC FEATURE TAGS3**
 - E.2.1 Talk Burst3
 - E.2.2 Group Advertisement3
 - E.2.3 Discrete Media3
 - E.2.4 PoC Dispatcher3
 - E.2.5 FDCFO Proceed.....3
 - E.2.6 PoC Interworking Service.....3
- E.3 SDP EXTENSIONS3**
 - E.3.1 Media Burst Control Protocol MIME registration3
 - E.3.1.1 Mapping TBCP MIME parameters into SDP.....3
 - E.3.2 QoE Profile3
- E.4 GENERAL3**
 - E.4.1 Release version in User-agent and Server headers.....3
- E.5 URI PARAMETERS3**
 - E.5.1 Session Type uri-parameter3
 - E.5.2 Dispatch Type uri-parameter3
 - E.5.3 Back to back UA uri-parameter3
 - E.5.4 URI Usage Type uri-parameter.....3
- E.6 XML SCHEMA EXTENSIONS3**
 - E.6.1 Extensions to PoC-Settings.....3
 - E.6.1.1 Structure.....3
 - E.6.1.2 XML Schema.....3
 - E.6.1.3 Validation Constraints3
 - E.6.1.4 Data Semantics.....3
 - E.6.1.5 XML example of PoC2.0 Service Settings3
- APPENDIX F. EXAMPLES OF SIGNALLING FLOWS (INFORMATIVE)3**
 - F.1 SIP REGISTRATION AND PUBLICATION OF POC SERVICE SETTINGS EVENT3**
 - F.2 POC CLIENT INITIATES A PRE-ESTABLISHED SESSION.....3**
 - F.3 PRE-ESTABLISHED SESSION3**
 - F.3.1 Originating flow – Confirmed Indication3
 - F.3.2 Terminating flow3
 - F.3.3 Originating flow - Unconfirmed Indication3
 - F.3.4 Terminating flow – Unconfirmed Indication3
 - F.4 AD-HOC AND 1-1 POC SESSION ESTABLISHMENT ON-DEMAND SESSION.....3**
 - F.4.1 Originating flow – Unconfirmed Indication.....3
 - F.4.2 Originating flow – Confirmed Indication with manual answer.....3
 - F.5 AD-HOC AND 1-1 POC SESSION ESTABLISHMENT ON-DEMAND SESSION.....3**
 - F.5.1 Terminating flow – Manual Answer3
 - F.5.2 Terminating flow – Automatic Answer3
 - F.6 REJOIN A PRE-ARRANGED POC GROUP SESSION3**
 - F.6.1 Using on-demand signaling3
 - F.7 JOINING A CHAT POC GROUP SESSION.....3**
 - F.7.1 Using on-demand signaling3
 - F.8 CANCELING A POC SESSION INITIALIZATION3**
 - F.8.1 Originating flow.....3
 - F.8.2 Terminating flow3
 - F.9 LEAVING/DISCONNECTING FROM A POC SESSION3**
 - F.9.1 Originating flow – On-demand Session case3
 - F.9.2 Originating flow – Pre-established Session case.....3
 - F.9.3 Terminating flow – On-demand Session Case.....3
 - F.9.4 Terminating flow – Pre-established Session Case3
 - F.10 SIMULTANEOUS POC SESSIONS LOCKING AND PRIORITY SETTING.....3**
 - F.11 PLACING MEDIA ON OR OFF HOLD3**
 - F.12 SESSION MODIFICATIONS3**
 - F.13 INSTANT PERSONAL ALERT3**
 - F.13.1 Originating flow.....3

- F.13.2 Terminating flow3
- F.14 EVENT SUBSCRIPTIONS3**
- F.14.1 PoC Client subscribing to Participant Information3
- F.14.2 Participating PoC Function subscribing to Participant Information.....3
- F.15 GROUP ADVERTISEMENT.....3**
- F.15.1 Originating flow.....3
- F.15.2 Terminating flow3
- F.16 DISPATCH PO C SESSION ESTABLISHMENT.....3**
- F.16.1 Originating flow – Invite the whole group – unconfirmed case.....3
- F.16.2 Terminating flow – Manual Answer Override procedure3
- F.17 FULL DUPLEX CALL FOLLOW-ON PROCEED3**
- F.17.1 Originating flow.....3
- F.17.2 Terminating flow3
- F.18 BACKWARD COMPATIBILITY3**
- F.18.1 Backward compatibility towards Controlling PoC Function3
- F.18.2 Backward compatibility towards terminating Participating PoC Function3
- F.19 DISCRETE MEDIA IN A SIP MESSAGE REQUEST3**
- F.19.1 Originating flow.....3
- F.19.2 Terminating flow3
- F.20 THE OPTIONS REQUEST3**
- F.20.1 Originating flow.....3
- F.20.2 Terminating flow3
- F.21 F.X UE PO C BOX 1-1 PO C SESSION ESTABLISHMENT ON-DEMAND SESSION.....3**
- F.21.1 Originating flow – PoC Session Establishment with a UE PoC Box.....3
- F.21.2 Terminating flow – UE PoC Box Accepts the PoC Session3
- F.21.3 Terminating flow – PoC User directs UE PoC Box to accept the PoC Session.....3
- APPENDIX G. CHANGE HISTORY (INFORMATIVE).....3**
- G.1 APPROVED VERSION HISTORY3
- G.2 DRAFT/CANDIDATE VERSION 2.0 HISTORY3

Figures

- Figure 1: The OMA PoC Management Object3
- Figure 2: The OMA PoC Management Object – QoE Profiles information3
- Figure 3: PoC Client A SIP registers with the SIP/IP Core A and PoC Client A publishes PoC Service Settings3
- Figure 4: PoC Client A initiates a Pre-established Session3
- Figure 5: PoC Client A invites another user to a Pre-established Session by sending a SIP REFER request to PoC Server A confirmed case.....3
- Figure 6: PoC Client A invites another PoC User to a Pre-established Session by sending a SIP REFER request to PoC Server A unconfirmed case3
- Figure 7: PoC Session invitation with automatic answer – Pre-established Session case.....3
- Figure 8: Ad-hoc PoC Session establishment on the originating side using on-demand signaling, unconfirmed case3
- Figure 9: Ad-hoc PoC Session establishment on the originating side using on-demand signaling, confirmed case manual answer3
- Figure 10: PoC Session invitation with manual answer3
- Figure 11: PoC Session invitation with automatic answer3
- Figure 12: Rejoin a Pre-arranged PoC Group Session.....3

Figure 13: Joining a Chat PoC Group Session.....3

Figure 14: Cancelling a PoC Session establishment, originating flow.....3

Figure 15: Cancelling a PoC Session establishment, terminating flow3

Figure 16: Leaving a PoC Session establishment, originating flow – On-demand Session case3

Figure 17: Leaving a PoC Session establishment, originating flow – Pre-established Session case.....3

Figure 18: Disconnecting a PoC Participant from a PoC Session, terminating flow – On-demand Session case3

Figure 19: Disconnecting a PoC Participant from a PoC Session, terminating flow – Pre-established Session case.....3

Figure 20: PoC Client A modifies the Simultaneous PoC Session parameters.....3

Figure 21: Placing media on or off hold.....3

Figure 22: PoC Session modifications3

Figure 23: PoC Client A sends an Instant Personal Alert to PoC Client B3

Figure 24: PoC Client B receives an Instant Personal Alert from PoC Client A3

Figure 25: A PoC Client subscribes to Participant Information3

Figure 26: A PoC Server performing the Participating PoC Function subscribes to Participant Information.....3

Figure 27: PoC Client A sends a Group Advertisement to a PoC Group.....3

Figure 28: PoC Client B receives a Group Advertisement from PoC Client A3

Figure 29: Dispatch PoC Session establishment with the whole Dispatch PoC Group on the originating side using on-demand signalling, unconfirmed case3

Figure 30: Dispatch PoC Session establishment on the terminating side with manual answer override.....3

Figure 31: PoC Client A sends the Full Duplex Call Follow-on Proceed request3

Figure 32: PoC Client B receives the Full Duplex Call Follow-on Proceed request3

Figure 33: Backward compatibility with the PoC Server performing the Controlling PoC Function compliant only to the PoC version 1.0 specification3

Figure 34: Backward compatibility with the PoC Server performing the terminating Participating PoC Function compliant only to the PoC version 1.0 specification.....3

Figure 35: Client A sends a Discrete Media in a SIP MESSAGE request.....3

Figure 36: PoC Client B receives the Discrete Media in a SIP MESSAGE request.....3

Figure 37: OPTIONS request, originating flow.3

Figure 38: OPTIONS request, terminating flow.....3

Figure 39: 1-1 PoC Session establishment on the originating side using on-demand signaling, establishment with a UE PoC Box3

Figure 40 : PoC Session invitation with UE PoC Box.....3

Figure 41: PoC Session invitation where PoC User directs UE PoC Box to accept the PoC Session3

Tables

Table 1: PoC specific warning texts	3
Table 2: PoC specific Presence states.....	3
Table 3: Definition of changes of presence attributes depending on PoC procedure	3

1. Scope

This document defines the Control Plane signaling procedures of the PoC Client, the PoC Box and the PoC Server for Push to talk over Cellular (PoC) service. Example detailed signaling flows for the reference points POC-1, POC-2, POC-9, POC-11 and IP-1 are also included in this specification.

This Control Plane specification is based on the procedures specified in [OMA-PoC-SD].

2. References

2.1 Normative References

- [3GPP TS 24.229] 3GPP TS 24.229: "IP multimedia call control protocol based on Session Initiation Protocol (SIP) and Session Description Protocol (SDP); Stage 3, (Release 7),
URL: http://www.3gpp.org/ftp/Specs/latest/Rel-7/24_series/
- [3GPP2 X.S0013.4] 3GPP2 X.S0013.4: "All-IP Core Network Multimedia Domain: IP Multimedia Call Control Protocol Based on SIP and SDP Stage 3",
URL: http://www.3gpp2.com/Public_html/specs/X.S0013-004-0_v1.0_022604.pdf
- [DMSTDOBJ] "OMA Device Management Standardized Objects", Version 1.2, Open Mobile Alliance™, OMA-TS-DM_StdObj-V1_2
URL: <http://www.openmobilealliance.org/>
- [DMTND] "OMA Device Management Tree and Description", Version 1.2, Open Mobile Alliance™, OMA-TS-DM_TND-V1_2
URL: <http://www.openmobilealliance.org/>
- [draft-answer-mode] draft-ietf-sip-answer-mode-06 (September 2007): "Requesting Answering Modes for the Session Initiation Protocol (SIP)", expires March 2008,
URL: <http://www.ietf.org/internet-drafts/draft-ietf-sip-answer-mode-06.txt>
- NOTE: The referenced IETF draft is a work in progress.
- [draft-multiple-refer] draft-ietf-sip-multiple-refer-03 (December 2007): "Referring to Multiple Resources in the Session Initiation Protocol (SIP)", expires June 2008,
URL: <http://www.ietf.org/internet-drafts/draft-ietf-sip-multiple-refer-03.txt>
- NOTE: The referenced IETF draft is a work in progress.
- [draft-URI-list] draft-ietf-sip-uri-list-conferencing-02 (November 2007): "Conference Establishment Using Request-Contained Lists in the Session Initiation Protocol (SIP)", expires May 2008,
URL: <http://www.ietf.org/internet-drafts/draft-ietf-sip-uri-list-conferencing-02.txt>
- NOTE: The referenced IETF draft is a work in progress.
- [draft-URI-list-capacity] draft-ietf-sipping-capacity-attribute-06 (December 2007): "Extensible Markup Language (XML) Format Extension for Representing Capacity Attributes in Resource Lists", expires June 2008,
URL: <http://www.ietf.org/internet-drafts/draft-ietf-sipping-capacity-attribute-06.txt>
- NOTE: The referenced IETF draft is a work in progress.
- [draft-URI-list-handling] draft-hautakorpi-sipping-uri-list-handling-refused-03 (November 2007): "The Session Initiation Protocol (SIP) P-Refused-URI-List Private-Header (P-Header)", expires May 2008,
URL: <http://www.ietf.org/internet-drafts/draft-hautakorpi-sipping-uri-list-handling-refused-03.txt>
- NOTE: The referenced IETF draft is a work in progress.
- [draft-uri-list-message] draft-ietf-sip-uri-list-message-03 (December 2007): "Multiple-Recipient MESSAGE Requests in the Session Initiation Protocol (SIP)", expires June 2008.
URL: <http://www.ietf.org/internet-drafts/draft-ietf-sip-uri-list-message-03.txt>

NOTE: The referenced IETF draft is a work in progress.

[OMA Client Provisioning]	OMA Client Provisioning, Version 1.1, Open Mobile Alliance™, OMA-ERP-ClientProvisioning-V1_1, URL: http://www.openmobilealliance.org/
[OMA DM]	"OMA Device Management Protocol", Version 1.2, Open Mobile Alliance™, OMA-TS-DM_Protocol-V1_2, URL: http://www.openmobilealliance.org/
[OMA IM TS]	"Instant Messaging using SIMPLE", Version 1.0, Open Mobile Alliance™, OMA-TS-SIMPLE_IM-V1_0, URL: http://www.openmobilealliance.org/
[OMA_IM_TS_ Endorsement]	"OMA PoC Endorsement of OMA IM TS", Version 2.0, Open Mobile Alliance™, OMA-TS-PoC_Endorsement_OMA_IM_TS-V2_0, URL: http://www.openmobilealliance.org/
[OMA_SCR_Rules]	"SCR Rules and Procedures", V1.0, Open Mobile Alliance™, OMA-ORG-SCR_Rules_and_Procedures-V1_0, URL: http://www.openmobilealliance.org/
[OMA-DM-3GPPPS-CONNMO]	"Standardized Connectivity Management Objects; 3GPP Packet Switched Bearer Parameters", Version 1.0, Open Mobile Alliance™, OMA-TS-DM_ConnMO_3GPPPS-V1_0, URL: http://www.openmobilealliance.org/
[OMA-POC-1-CP]	"OMA PoC Control Plane", Version 1.0, Open Mobile Alliance™, OMA-TS-PoC_ControlPlane-V1_0_1, URL: http://www.openmobilealliance.org/
[OMA-POC-1-UP]	"PoC User Plane", Version 1.0, Open Mobile Alliance™, OMA-TS-PoC_UserPlane-V1_0_1, URL: http://www.openmobilealliance.org/
[OMA-PoC-AC]	"OMA Push to talk over Cellular (PoC) Application Characteristics File", Version 2.0, Open Mobile Alliance™, OMA-SUP-AC_ap0006_POC-V2_0, URL: http://www.openmobilealliance.org/
[OMA-PoC-Document-Mgmt]	"OMA PoC Document Management", Version 2.0, Open Mobile Alliance™, OMA-TS-PoC_Document_Management-V2_0, URL: http://www.openmobilealliance.org/
[OMA-POC-FDCFO]	"PoC - Full Duplex Call Follow On Proceed postd Element", Version 2.0, Open Mobile Alliance™, OMA-SUP-XSD_poc_FDCFO-V2_0, URL: http://www.openmobilealliance.org/
[OMA-POC-PARTICIPANTINFO IND]	"PoC - Participant Information Indications", Version 2.0, Open Mobile Alliance™, OMA-SUP-XSD_poc_participant-info-ind, URL: http://www.openmobilealliance.org/
[OMA-POC-POC2.0-SETTINGS]	"PoC - PoCv2.0 Service Settings", Version 2.0, Open Mobile Alliance™, OMA-SUP-XSD_poc_poc2_0Settings-V2_0, URL: http://www.openmobilealliance.org/
[OMA-PoC-SD]	"OMA PoC System Description", Version 2.0, Open Mobile Alliance™, OMA-TS-PoC_System_Description-V2_0, URL: http://www.openmobilealliance.org/
[OMA-PoC-UP]	"OMA PoC User Plane", Version 2.0, Open Mobile Alliance™, OMA-TS-PoC_UserPlane-V2_0, URL: http://www.openmobilealliance.org/
[OMA-Pres-Spec]	"Presence SIMPLE Specification ", Version 1.0, Open Mobile Alliance™,

- OMA-TS-Presence_SIMPLE-V1_0,
URL: <http://www.openmobilealliance.org/>
- [RFC2046] IETF RFC 2046 (November 1996): "Multipurpose Internet Mail Extensions (MIME) Part Two: Media Types",
URL: <http://www.ietf.org/rfc/rfc2046.txt>
- [RFC2119] IETF RFC 2119 (March 1997): "Key words for use in RFCs to Indicate Requirement Levels", S. Bradner, March 1997,
URL: <http://www.ietf.org/rfc/rfc2119.txt>
- [RFC2396] IETF RFC 2396 (August 1998): "Uniform Resource Identifiers (URI): Generic Syntax"
URL: <http://www.ietf.org/rfc/rfc2396.txt>
- [RFC3108] IETF RFC 3108 (May 2001): "Conventions For the Use of The Session Description Protocol (SDP) for ATM Bearer Connections",
URL: <http://www.ietf.org/rfc/rfc3108.txt>
- [RFC3261] IETF RFC 3261 (June 2002): "SIP: Session Initiation Protocol",
URL: <http://www.ietf.org/rfc/rfc3261.txt>
- [RFC3262] IETF RFC 3262 (June 2002): "Reliability of Provisional Responses in the Session Initiation Protocol (SIP)",
URL: <http://www.ietf.org/rfc/rfc3262.txt>
- [RFC3264] IETF RFC 3264 (June 2002): "An Offer/Answer Model with the Session Description Protocol (SDP)",
URL: <http://www.ietf.org/rfc/rfc3264.txt>
- [RFC3265] IETF RFC 3265 (June 2002): "Session Initiation Protocol (SIP)-Specific Event Notification",
URL: <http://www.ietf.org/rfc/rfc3265.txt>
- [RFC3311] IETF RFC 3311 (September 2002) "The Session Initiation Protocol (SIP) UPDATE Method",
URL: <http://www.ietf.org/rfc/rfc3311.txt>
- [RFC3312] IETF RFC 3312 (October 2002): "Integration of Resource Management and Session Initiation Protocol (SIP)",
URL: <http://www.ietf.org/rfc/rfc3312.txt>
- [RFC3320] IETF RFC 3320 (January 2003): "Signaling Compression (SigComp)",
URL: <http://www.ietf.org/rfc/rfc3320.txt>
- [RFC3321] IETF RFC 3321 (January 2003): "Signaling Compression (SigComp) - Extended Operations",
URL: <http://www.ietf.org/rfc/rfc3321.txt>
- [RFC3323] IETF RFC 3323 (November 2002): "A Privacy Mechanism for the Session Initiation Protocol (SIP)",
URL: <http://www.ietf.org/rfc/rfc3323.txt>
- [RFC3325] IETF RFC 3325 (November 2002): "Private Extensions to the Session Initiation Protocol (SIP) for Asserted Identity within Trusted Networks",
URL: <http://www.ietf.org/rfc/rfc3325.txt>
- [RFC3420] IETF RFC 3420 (November 2002): "Internet Media Type message/sipfrag",
URL: <http://www.ietf.org/rfc/rfc3420.txt>
- [RFC3428] IETF RFC 3428 (December 2002): "Session Initiation Protocol (SIP) Extension for Instant Messaging",
URL: <http://www.ietf.org/rfc/rfc3428.txt>
- [RFC3485] IETF RFC 3485 (February 2003): "The Session Initiation Protocol (SIP) and Session Description Protocol (SDP) Static Dictionary for Signaling Compression (SigComp)",
URL: <http://www.ietf.org/rfc/rfc3485.txt>
- [RFC3486] IETF RFC 3486 (February 2003): "Compressing the Session Initiation Protocol (SIP)",

- URL: <http://www.ietf.org/rfc/rfc3486.txt>
- [RFC3515] IETF RFC 3515 (April 2003): "The Session Initiation Protocol (SIP) REFER Method",
URL: <http://www.ietf.org/rfc/rfc3515.txt>
- [RFC3550] IETF RFC 3550 (July 2003): "RTP: A Transport Protocol for Real-Time Applications."
URL: <http://www.ietf.org/rfc/rfc3550.txt>
- [RFC3605] IETF RFC 3605 (October 2003): "Real Time Control Protocol (RTCP) attribute in Session Description Protocol (SDP)",
URL: <http://www.ietf.org/rfc/rfc3605.txt>
- [RFC3840] IETF RFC 3840 (August 2004): "Indicating User Agent Capabilities in the Session Initiation Protocol (SIP)",
URL: <http://www.ietf.org/rfc/rfc3840.txt>
- [RFC3680] IETF RFC 3680 (March 2004) "A Session Initiation Protocol (SIP) Event Package for Registrations"
URL: <http://www.ietf.org/rfc/rfc3680.txt>
- [RFC3841] IETF RFC 3841 (August 2004): "Caller Preferences for the Session Initiation Protocol (SIP)",
URL: <http://www.ietf.org/rfc/rfc3841.txt>
- [RFC3892] IETF RFC 3892 (September 2004): "The Session Initiation Protocol (SIP) Referred-By Mechanism",
URL: <http://www.ietf.org/rfc/rfc3892.txt>
- [RFC3903] IETF RFC 3903 (October 2004): "Session Initiation Protocol (SIP) Extension for Event State Publication",
URL: <http://www.ietf.org/rfc/rfc3903.txt>
- [RFC4028] IETF RFC 4028 (April 2005): "Session Timers in the Session Initiation Protocol (SIP)",
URL: <http://www.ietf.org/rfc/rfc4028.txt>
- [RFC4145] IETF RFC 4145 (September 2005): "TCP-Based Media Transport in the Session Description Protocol (SDP)".
URL: <http://www.ietf.org/rfc/rfc4145.txt>
- [RFC4244] IETF RFC 4244 (November 2005): "An Extension to the Session Initiation Protocol (SIP) for Request History Information",
URL: <http://www.ietf.org/rfc/rfc4244.txt>
- [RFC4354] IETF RFC 4354 (January 2006): "A Session Initiation Protocol (SIP) Event Package and Data Format for Various Settings in Support for the Push-to-talk Over Cellular (PoC) Service",
URL: <http://www.ietf.org/rfc/rfc4354.txt>
- [RFC4412] IETF RFC 4412 (February 2006): "Communications Resource Priority for the Session Initiation Protocol (SIP)",
URL: <http://www.ietf.org/rfc/rfc4412.txt>
- [RFC4458] IETF RFC 4458 (April 2006): "Session Initiation Protocol (SIP) URIs for Applications such as Voicemail and Interactive Voice Response (IVR)",
URL: <http://www.ietf.org/rfc/rfc4458.txt>
- [RFC4488] IETF RFC 4488 (May 2006): "Suppression of Session Initiation Protocol (SIP) REFER Method Implicit Subscription",
URL: <http://www.ietf.org/rfc/rfc4488.txt>
- [RFC4538] IETF RFC 4538 (June 2006): "Request Authorization through Dialog Identification in the Session Initiation Protocol (SIP)",
URL: <http://www.ietf.org/rfc/rfc4538.txt>
- [RFC4566] IETF RFC 4566 (July 2006): "SDP: Session Description Protocol",

- URL: <http://www.ietf.org/rfc/rfc4566.txt>
- [RFC4574] IETF RFC 4574 (August 2006), "The Session Description Protocol (SDP) Label Attribute",
URL: <http://www.ietf.org/rfc/rfc4574.txt>
- [RFC4575] IETF RFC 4575 (August 2006): "A Session Initiation Protocol (SIP) Event Package for
Conference State",
URL: <http://www.ietf.org/rfc/rfc4575.txt>
- [RFC4583] IETF RFC 4583 (November 2006): "Session Description Protocol (SDP) Format for Binary
Floor Control Protocol (BFCP) Streams".
URL: <http://www.ietf.org/rfc/rfc4583.txt>
- [RFC4964] IETF RFC 4964 (October 2007): "The P-Answer-State Header Extension to the Session
Initiation Protocol for the Open Mobile Alliance Push-to-talk over Cellular".
URL: <http://www.ietf.org/rfc/rfc4964.txt>
- [RFC4975] IETF RFC 4975 (September 2007): "The Message Session Relay Protocol (MSRP)",
URL: <http://www.ietf.org/rfc/rfc4975.txt>
- [RFC5079] IETF RFC 5079 (December 2007): "Rejecting Anonymous Requests in the Session Initiation
Protocol (SIP)",
URI: <http://www.ietf.org/rfc/rfc5079.txt>
- [RFC5234] IETF RFC 5234 (January 2008): "Augmented BNF for Syntax Specifications: ABNF",
URL: <http://www.ietf.org/rfc/rfc5234.txt>
- [sip-outbound] draft-ietf-sip-outbound-10 (July 2007): "Managing Client Initiated Connections in the Session
Initiation Protocol (SIP)", expires January, 2008,
URL: <http://www.ietf.org/internet-drafts/draft-ietf-sip-outbound-10.txt>

NOTE: The referenced IETF draft is a work in progress.

- [XDM-Core] "XML Document Management (XDM) Specification", Version 2.0, Open Mobile Alliance™,
OMA-TS-XDM_Core-V2_0,
URL: <http://www.openmobilealliance.org/>
- [XDM-Pres-EXT] "Presence SIMPLE Data Specification", Version 1.0, Open Mobile Alliance™, OMA-DDS-
Presence_Data_Ext-V1_0,
URL: <http://www.openmobilealliance.org/>
- [XDM-Shared-
Groups] "Shared Group XDM Specification", Version 1.0, Open Mobile Alliance™,
OMA-TS-XDM_Shared_Group-V1_0,
URL: <http://www.openmobilealliance.org/>
- [XSD_XDM2_EXT] "XDM2 - Extensions", Version 1.0, Open Mobile Alliance™,
OMA-SUP-XSD_xdm_extensions-V1_0,
URL: <http://www.openmobilealliance.org/>

2.2 Informative References

- [3GPP TS 23.218] 3GPP TS 23.218: "IP Multimedia (IM) session handling; IM call model; Stage 2", (Release 5)
URL: http://www.3gpp.org/ftp/Specs/latest/Rel-5/23_series/
- [3GPP TS 29.228] 3GPP TS 29.228: "IP Multimedia (IM) Subsystem Cx and Dx interfaces; Signalling flows and
message contents", (Release 6)
URL: http://www.3gpp.org/ftp/Specs/latest/Rel-6/29_series/
- [OMA-PoC-AD] "OMA Push to talk over Cellular (PoC) – Architecture", Version 2.0, Open Mobile Alliance™,
OMA-AD-PoC-V2_0,

**[Provisioning
Content]**

URL: <http://www.openmobilealliance.org/>

"Provisioning Content", Version 1.1, Open Mobile Alliance™, OMA-WAP-TS-ProvCont-V1_1

URL: <http://www.openmobilealliance.org/>

3. Terminology and Conventions

3.1 Conventions

The key words "MUST", "MUST NOT", "REQUIRED", "SHALL", "SHALL NOT", "SHOULD", "SHOULD NOT", "RECOMMENDED", "MAY", and "OPTIONAL" in this document are to be interpreted as specified in [RFC2119].

All subclauses and appendixes, except clause 1 "*Scope*" and clause 4 "*Introduction*", are normative, unless they are explicitly indicated to be informative.

3.2 Definitions

1-1 PoC Session	A feature enabling a PoC User to establish a PoC Session with another PoC User
1-many-1 PoC Group Session	A PoC Session established by a PoC User to a Pre-arranged PoC Group, in which one Participant is a Distinguished Participant and other Participants are Ordinary Participants.
Access Control	PoC User specified rules that define the interactions with other PoC Users, e.g. rules restricting other PoC Users that may try to establish PoC Sessions to the PoC User.
Active PoC Dispatcher	PoC User currently taking the role of PoC Dispatcher for all the Dispatch PoC Sessions of a Dispatch PoC Group. The Active PoC Dispatcher can change along time between PoC Users that are allowed the role of PoC Dispatcher for the Dispatch PoC Group (e.g. through role transfer mechanisms)
Active PoC Session	A PoC Session that carries both RTP and MBCP/TBCP based packets to the PoC User. If the PoC User has multiple PoC Sessions, at most only one can be active at any given time.
Ad-hoc PoC Group Session	A PoC Group Session established by a PoC User to PoC Users listed on the invitation. The list includes PoC Users or PoC Groups or both.
Anonymous PoC Address	A PoC Address identifies a PoC User who has requested privacy. The Anonymous PoC Address is of the form that the hostname of URI is "anonymous.invalid" and 'user' is of the form "anonymous-n". Anonymous PoC Addresses are scoped within a given PoC Session.
Answer Mode	A PoC Client mode of operation for the terminating PoC Session invitation handling.
Answer Mode Indication	A PoC Service Setting indicating the current Answer Mode of the PoC Client.
Application Server	In 3GPP/3GPP2 IMS, a functional entity that implements the service logic for SIP sessions. When the SIP/IP Core used for the PoC service is according to 3GPP/3GPP2 IMS, the PoC Server implements the Application Server functionality.
Audio	General communication of sound with the exception of PoC Speech.
Authenticated Originator's PoC Address	The Authenticated Originator's PoC Address is the PoC Address of the PoC User at the originating or terminating PoC Client that has been validated by the SIP/IP Core or the PoC Group Identity used by the PoC Server performing the Controlling PoC Function when inviting PoC Users to a PoC Group Session.
Automatic Answer Mode	Answer Mode where the PoC Client accepts a PoC Session establishment request without manual intervention from the PoC User. The Media is immediately played when received.
Chat PoC Group	A persistent PoC Group in which a PoC User individually joins to have a PoC Session with other joined PoC Users, i.e., the establishment of a PoC Session to a Chat PoC Group does not result in other PoC Users being invited.
	NOTE: A Chat PoC Group is a persistent PoC Group where the <invite-members> element is set to "false" as specified in the [OMA-PoC-Documents-Mgmt] " <i>PoC Group</i> ".
Chat PoC Group Identity	PoC Group Identity of a Chat PoC Group.
Chat PoC Group Session	A PoC Session established to a Chat PoC Group.
Conference-factory-URI	A Conference-Factory-URI for PoC service is a provisioned SIP URI that identifies the PoC service in the Home PoC Network.

Confirmed Indication	A signalling message returned by the PoC Server to confirm that the PoC Server, all other network elements intermediary to the PoC Server and a terminating PoC Client are able and willing to receive Media.
Control Plane	The specification of the signalling between PoC Client and PoC Server, between PoC Box and PoC Server and between PoC Servers for the Push to talk over Cellular (PoC) service.
Controlling PoC Function	A function implemented in a PoC Server, providing centralized PoC Session handling, which includes Media distribution, Talk Burst Control, Media Burst Control, policy enforcement for participation in the PoC Group Sessions, and the Participant information.
Discrete Media	Media that itself does not contain an element of time (e.g. images, text).
Discrete Media Transfer Final Report	A report sent to the sending PoC Client to indicate final status of the Discrete Media transfer to the receiving PoC Clients.
Discrete Media Transfer Progress Report	A report sent to the sending PoC Client to indicate progress of the Discrete Media transfer to the receiving PoC Clients.
Dispatch PoC Group	A Pre-arranged PoC Group in which one member is assigned the role of PoC Dispatcher and the other member(s) are assigned the role of PoC Fleet Members.
Dispatch PoC Session	The PoC Session of a Dispatch PoC Group, or a subset of the Dispatch PoC Group, in which the 1-many-1 communication method is used.
Distinguished Participant	A Participant in a 1-many-1 Session that sends Media to all Ordinary Participants, and that receives Media from any Ordinary Participant. NOTE: The <is-key-participant> is set to "true" as specified in [OMA-PoC-Documents-Mgmt] to indicate who is the Distinguished Participant.
Exploder URI	An Exploder URI is an address of a SIP URI-list service. A URI-list service is a specialized application service that receives a SIP request with a list of URIs and generates a similar SIP request to each of the URIs on the list. The SIP URI-list service includes a copy of the body of the original SIP request in the generated SIP requests.
Filter Criteria	Filter Criteria is routing logic used in the 3GPP/3GPP2 IMS SIP/IP Core to route SIP requests to the correct Application Server.
Full Duplex Call Follow-on Proceed	A feature which allows PoC Session Participant to request the other PoC Session Participants to set up another independent full duplex voice call (either a circuit switched voice call or voice-over-IP call, subject to Service Provider Policy and configuration). The full duplex voice call set up is out of the scope of this specification.
Group	A predefined set of Users together with its policies and attributes. A Group is identified by a SIP URI.
Group Advertisement	A feature that provides the capability to inform other PoC Users of the existence of a PoC Group.
Group List	A list of members in a Pre-arranged PoC Group or restricted Chat PoC Group. Each member is identified by a SIP URI or a TEL URI.
Home PoC Network	A network comprising a Home PoC Server and SIP/IP Core operated by the PoC User's PoC service provider. The Home PoC Network is the same as the Home Network defined in 3GPP/3GPP2 IMS specifications.
Home PoC Server	The PoC Server of the PoC Service Provider that provides PoC service to the PoC User.
Implicit Media Burst Request	A Media Burst request that is inferred from the receipt of a SIP INVITE request or a SIP REFER request.
Included Media Content	Media content included in an invitation to a PoC Session or in a Group Advertisement.
Incoming Instant Personal Alert Barring	A PoC Service Setting for the PoC Client that indicates the PoC User's desire for the PoC service to block all incoming Instant Personal Alerts.
Incoming PoC Session Barring	A PoC Service Setting for the PoC Client that indicates the PoC User's desire for the PoC service to block all incoming PoC Session requests.
Instant Personal Alert	A feature in which a PoC User sends a SIP based instant message to a PoC User requesting a 1-1 PoC Session.

Instance Identifier URN	A global unique identifier identifying a PoC Client created as specified in [sip-outbound].
Invited Parties Identity Information Mode	A PoC Service Setting for the PoC Server that indicates that the PoC Client is able and PoC User is willing to receive invited parties identity information.
Invited PoC Client	A PoC Client that is invited to a PoC Session.
Invited PoC User	The PoC User who has been invited to a PoC Session.
Inviting PoC Client	A PoC Client that invites other PoC User(s) to a PoC Session.
Inviting PoC User	The PoC User who invites other PoC User(s) to a PoC Session.
Limited Segment Media Buffer	A PoC Client buffer that contains a small initial segment of the total buffered Media that can be transmitted to the PoC Server before the called PoC Client answers in order to minimise the delay due to the Media transmit delay latency.
Local QoE Profile	QoE Profile that a PoC Client locally applies for a given PoC Session. The Local QoE Profile is intended to be equal to the QoE Profile assigned for the PoC Session but it may differ based on restrictions associated to the subscription of the local PoC User (e.g. 'Basic' PoC Users participate with 'Basic' QoE Profile in PoC Sessions with 'Professional' QoE Profile).
Manual Answer Mode	A mode of operation in which the PoC Client requires the PoC User to manually accept the PoC Session invitation before the PoC Session is established.
Media	Forms of information that are exchanged between Participants. Media may come in different forms, which are referred to as Media Types.
Media Burst	Flow of Media from a PoC Client that has the permission to send Media to the receiving PoC Client(s).
Media Burst Control	Media Burst Control is a control mechanism that arbitrates requests from the PoC Clients, for the right to send Media and Multimedia.
Media Burst Control Protocol	Media Burst Control Protocol (MBCP) is a protocol for performing Media Burst Control, and is defined in [OMA-PoC-UP].
Media Burst Control Schemes	Way of using Media Burst Control according to predefined rules and procedures.
Media Parameters	Media Parameters are SIP/SDP based information exchanged between the PoC Server and the PoC Client, between the PoC Server and the PoC Box and between PoC Servers that specify the characteristics of the Media for a PoC Session being established or that already exists.
Media Stream	An instance of the transmission of a Media Type, which is used as the basic unit to distinguish each Media flow. Multiple Media Streams can be combined to transmit multimedia.
Media Time Compression	A PoC Client operation on Media data to be transmitted, which compresses the Media in time such that the compressed Media data will be played out in a shorter time duration than the original uncompressed Media data.
Media Type	Media Types share a characteristic of human perception. Media Types are either realtime or non-realtime, like: <ul style="list-style-type: none"> • PoC Speech • Audio (e.g. music) • Video • Discrete Media (e.g. still image, formatted and non-formatted text, file)
Media-floor Control	The mechanism to control separate Media streams.
Media-floor Control Entity	A Media Control resource shared by Participants in a PoC Session. The Media-floor Control Entity is controlled by a state machine to ensure that only one Participant can access the Media resource at the same time. One Media-floor Control Entity can handle one or more Media Streams according to negotiation.
Multimedia	Multimedia is the simultaneous existence of multiple Media Types like <ul style="list-style-type: none"> • audiovisual • video plus subtitles Multimedia from a single source that involves real-time Media Types are assumed to be synchronized.

Nick Name	A user-friendly display name that might be associated to a PoC User or a PoC Group. The Nick Name can either be provided as a "display-name" in a SIP header or in the <display-name> child element of the <entry> element for the PoC User or for the PoC Group as specified in [OMA-PoC-Documents-Mgmt] or generated by PoC Server performing the Controlling PoC Function if unique Nick Names are supported and PoC User requested privacy.
NW PoC Box	A PoC functional entity in the PoC Network where PoC Session Data and PoC Session Control Data can be stored.
On-demand Session	A PoC Session set-up mechanism in which all Media Parameters are negotiated at PoC Session establishment.
Ordinary Participant	A Participant in a 1-many-1 PoC Group Session that is only able to send and receive Media to and from the Distinguished Participant.
Originating PoC Service Point Trigger	An Originating PoC Service Point Trigger is a filter criterion for a dialog initiating SIP request from a (PoC) SIP User Agent. For a definition and additional information on "Service Point Triggers" when the SIP/IP core is 3GPP/3GPP2 IMS, see [3GPP TS 29.228] or [3GPP2 X.S0013.005] for more information.
P2T User	A P2T User is a user of the P2T service provided by an External P2T Network.
Participant	A Participant is a PoC User in a PoC Session.
Participating PoC Function	A function implemented in a PoC Server, which provides PoC Session handling, which includes policy enforcement for incoming PoC Sessions and relays Talk Burst Control and Media Burst Control messages between the PoC Client and the PoC Server performing the Controlling PoC Function. The Participating PoC Function may also relay RTP Media between the PoC Client and the PoC Server performing the Controlling PoC Function.
PoC Address	An address identifying a PoC User. The PoC Address can be used by one PoC User to request communication with other PoC Users. If SIP/IP Core is the 3GPP/3GPP2 IMS the PoC Address is a public user identity.
PoC Box	A PoC functional entity where PoC Session Data and PoC Session Control Data can be stored. It can be a NW PoC Box or a UE PoC Box.
PoC Client	A functional entity that resides on the User Equipment that supports the PoC service.
PoC Dispatcher	The Participant in a Dispatch PoC Session that sends Media to all PoC Fleet Members and that receives Media from any PoC Fleet Member. NOTE: The PoC Dispatcher is an enhancement to the PoC 1 Distinguished Participant.
PoC Fleet Member	A Participant in a Dispatch PoC Session that is only able to send Media to the PoC Dispatcher, and that likewise is only able to receive Media from the PoC Dispatcher. NOTE: PoC Fleet Member is the same as Ordinary Participant in PoC 1.
PoC Group	A Group supporting the PoC service. PoC User uses PoC Groups e.g. to establish PoC Group Sessions.
PoC Group Identity	A SIP URI identifying a Pre-arranged PoC Group or Chat PoC Group. A PoC Group Identity is used by the PoC Client e.g. to establish PoC Group Sessions to the Pre-arranged PoC Groups and Chat PoC Groups.
PoC Group Name	Indicates the name of the PoC Group that can be presented to the PoC User.
PoC Group Session	A Pre-arranged PoC Group Session, Ad-hoc PoC Group Session or Chat PoC Group Session.
PoC Interworking Agent	Abstract entity implemented in the PoC Interworking Function, acting as a PoC Client on behalf of a PoC Remote Access User or a P2T User.
PoC Interworking Function	Part of the PoC Interworking Service, it provides conversion between PoC Network based SIP signaling, Talk Burst Control and Media Burst Control Protocol, and Media packet transport, and External P2T Network based session signaling, floor control, and Media transport protocol.
PoC Interworking Service	A means to extend the PoC User experience beyond the OMA defined PoC service and PoC Network boundaries, accomplished by interworking with other networks and systems, while not PoC compliant, being able to provide a reasonably comparable capability, involving simplex Media based conferencing.

PoC Media Traffic Optimisation	A mechanism for reducing PoC Media traffic via the PoC-4 reference point.
PoC Network	Network comprising a SIP/IP Core and PoC Server(s), which provide PoC capabilities to the associated PoC capable User Equipments which are compliant with OMA PoC Service Enabler specifications.
PoC Remote Access User	A user of the PoC service accessing the service potentially via a non IMS enabled SIP/IP based network, not necessarily using a PoC Client (e.g. a PoC User, with a valid subscription, accessing PoC services via a PSTN terminal).
PoC Server	A network element, which implements the 3GPP/3GPP2 IMS application level network functionality for the PoC service. A PoC Server can perform the role of the Controlling PoC Function or Participating PoC Function, or both at the same time.
PoC Service Provider	A PoC Service Provider provides PoC Service – on its own or in conjunction with other Value Added Services – to his PoC Subscribers.
PoC Service Setting	A set of parameters indicating the capability of the PoC Client and the willingness of the PoC User to support related PoC Client and PoC Server functionalities, e.g. Answer Mode Indication, Incoming PoC Session Barring, Incoming Instant Personal Alert Barring and Simultaneous PoC Sessions Support.
PoC Session	A PoC Session is a SIP Session established by the procedures of this specification. This specification supports the following types of PoC Sessions: 1-1 PoC Session, Ad-hoc PoC Group Session, Pre-arranged PoC Group Session, or Chat PoC Group Session.
PoC Session Control Data	Information about PoC Session Data e.g. time and date, PoC Session initiator.
PoC Session Data	Media Bursts and Media Burst Control information exchanged during a PoC Session e.g. Video frames, an image or Talk Burst.
PoC Session Identity	SIP URI, which identifies the PoC Session and which can be used for routing initial SIP requests. It is received by the PoC Client during the PoC Session establishment in the Contact header and/or in the MBCP Connect message in case of using Pre-established Session.
PoC Session Precedence	A level of priority determined based on the Service Provider Policy and the QoE Profile associated with the PoC Session. It controls how the PoC Session is treated under competing situations with other PoC Sessions and may result in a preferred treatment for those PoC Sessions with a higher PoC Session Precedence. The definition of different levels to be applied for this feature is a decision that belongs to the PoC Service Provider. NOTE: A level of priority can be determined for each of four existing QoE Profiles. When 'Official Government Use' QoE Profile is used, five sub-levels of priority are determined for this QoE Profile, according to rules in [RFC4412] and WPS namespace.
PoC Speech	Communication of speech as defined by PoC version 1.0.
PoC Subscriber	Is one whose service subscription includes the PoC service. A PoC Subscriber can be the same person as a PoC User. NOTE: In [PoC RD V1.0] the term "PoC Subscriber" is sometimes used to mean the same as term "PoC User" in [OMA PoC AD], [OMA PoC CP] and [OMA PoC UP].
PoC User	A User of the PoC service. A PoC User can be the same person as a PoC Subscriber. A PoC User uses the PoC features through the User Equipment.
Pre-arranged PoC Group	A persistent PoC Group. The establishment of a PoC Session to a Pre-arranged PoC Group results in the members being invited. NOTE: A Pre-arranged PoC Group is a persistent PoC Group, where the <invite-members> element is set to "true" as specified in the [OMA-PoC-Documents-Mgmt] "PoC Group".
Pre-arranged PoC Group Session	A PoC Session established by a PoC User to a Pre-arranged PoC Group.

Pre-established Session	The Pre-established Session is a SIP Session established between the PoC Client and the Home PoC Server containing at least one Media Stream bound to a Media-floor Control Entity. The PoC Client establishes the Pre-established Session prior to making requests for PoC Sessions to other PoC Users. To establish a PoC Session based on a SIP request from the PoC User, the PoC Server conferences other PoC Servers/Users to the Pre-established Session so as to create an end-to-end connection.
Primary PoC Session	A PoC Session that the PoC User selects in preference to other PoC Sessions. When the PoC User has Simultaneous PoC Sessions, the Primary PoC Session has a priority over Secondary PoC Sessions.
QoE Profile	Set of parameters that establish, from a high level point of view, the end PoC User experience in a given PoC Session. The QoE Profile is part of the PoC User's subscription and can also be specified for PoC Groups. Each QoE Profile is associated with certain rules for underlying resource usage and potential prioritization procedures.
Referenced Media Content	Reference(s) to media content to be included in an invitation to a PoC Session or in a Group Advertisement.
Request with Media Content	An invitation to a PoC Session or a Group Advertisement that includes embedded media e.g. Included Media Content, Referenced Media Content or Text Content
Restricted Group	A Group that can be joined only by a PoC User that is a member of the Group. A Restricted Group has a Group List.
RTP Media	The media carried in an RTP payload.
RTP Session	Considered as an association that allows exchange of RTP Media streams and RTCP messages among a set of PoC functional entities.
Secondary PoC Session	A PoC Session for which the PoC User receives Media when there is no Media present on the Primary PoC Session.
Sender Identification	The procedure by which the identity of the current Media sender is determined and made known to receivers on the PoC Session.
Served PoC User	A PoC User that obtains a PoC service from a Home PoC Server.
Service Provider Policy	Service Provider Policy refers to the overall policy conditions actually selected by a service provider(s) for commercial implementation of a PoC service. Service Provider Policy is established based on commercial considerations, which may concern, e.g. support/non-support of certain network or client capabilities or service features within a network. Service Provider Policy is applicable only to the network or subscribers over which the service provider has control.
Session Type	A Session Type is a SIP URI-parameter used to convey the type of SIP URI, and may take on one of the following values: adhoc, prearranged, chat or 1-1.
SigComp	A signaling compression mechanism specified in [RFC3320]; SigComp in PoC provides for the compression of SIP requests and responses.
Simultaneous PoC Session	Functionality, where Home PoC Server discards Media for keeping conversation uninterrupted, in case a PoC User is a Participant in more than one PoC Session simultaneously using the same PoC Client.
Simultaneous PoC Sessions Support	A PoC Service Setting for the PoC Client that indicates that the PoC Client is able and PoC User is willing to use Simultaneous PoC Sessions.
SIP Session	A SIP dialog. From [RFC 3261], a SIP dialog is defined as follows: A dialog is a peer-to-peer SIP relationship between two UAs that persists for some time. A dialog is established by SIP messages, such as a 2xx response to an INVITE request. A dialog is identified by a call identifier, local tag, and a remote tag. A dialog was formerly known as a call leg in [RFC 2543].
SIP URI	From [RFC 3261]: "A SIP or SIPS URI identifies a communications resource" and "follows the guidelines in [RFC 2396]". PoC uses SIP URIs to identify PoC Clients, PoC Servers, and PoC Sessions, resource lists that point to URI lists, etc.
SIP User Agent	A SIP User Agent is any SIP peer that performs SIP signaling [RFC3261].
Talk Burst	A flow of PoC Speech from a PoC Client having the permission to send PoC Speech as specified in [OMA PoC V1.0].
Talk Burst Control	A control mechanism that arbitrates requests from the PoC Clients for the right to send PoC Speech as specified in [OMA PoC V1.0].

Talk Burst Control Protocol	A protocol for performing Talk Burst Control defined in [OMA PoC V1.0 UP].
Talker Identification	A procedure by which the current talker's identity is determined and made known to listeners on the PoC Session.
Terminating PoC Service Point Trigger	A Terminating PoC Service Point Trigger is a filter criterion for a dialog initiating SIP request to a (PoC) SIP User Agent. For a definition and additional information on "Service Point Triggers" when the SIP/IP core is 3GPP/3GPP2 IMS, see [3GPP TS 29.228] or [3GPP2 X.S0013.005] for more information.
Text Content	Text included in an invitation to a PoC Session or in a Group Advertisement.
UE PoC Box	A functional entity co-located with the PoC Client in the User Equipment where PoC Session Data and PoC Session Control Data can be stored.
Unconfirmed Indication	An indication returned by the PoC Server to confirm that it is able to receive Media and believes the PoC Client is able to accept Media. The PoC Server sends the Unconfirmed Indication prior to determining that all elements on the forward path are ready or even able to receive Media.
Unrestricted Group User	An Unrestricted Group is a PoC Group that any PoC User may join.
User	Any entity that uses the described features through the User Equipment.
User Equipment	A hardware device that supports a PoC Client e.g., a wireless phone.
User Plane	The User Plane includes the Media and Media control signaling (e.g., Talk Burst Control Protocol) between the PoC Client and PoC Server, between the PoC Box and the PoC Server as well as between PoC Servers.
Video	Communication of live-streamed pictures without any Audio component.

3.3 Abbreviations

3GPP	3rd Generation Partnership Project
3GPP2	3rd Generation Partnership Project 2
AD	Architecture Document
B2BUA	Back to Back User Agent
DM	Device Management
FDCFO	Full Duplex Call Follow-On Proceed
IAB	Incoming Personal Alert Barring
IANA	Internet Assigned Numbers Authority
IETF	Internet Engineering Task Force
IMS	IP Multimedia Subsystem
IP	Internet Protocol
ISB	Incoming PoC Session Barring
MBCP	Media Burst Control Protocol
MIME	Multipurpose Internet Mail Extensions
MO	Management Object
MSRP	Message Session Relay Protocol

NOTE: The base Message Session Relay Protocol is defined in [RFC4975].

NAT	Network Address Translation
OMA	Open Mobile Alliance
PDA	Personal Digital Assistant

PoC	Push to talk over Cellular
QoE	Quality of Experience
QoS	Quality of Service
RFC	Request For Comments (IETF specifications)
RTCP	RTP Control Protocol
RTP	Real-time Transport Protocol
SCR	Static Conformance Requirements
SDP	Session Description Protocol
SIP	Session Initiation Protocol
SSS	Simultaneous PoC Sessions Support
TBCP	Talk Burst Control Protocol
TS	Technical Specification (3GPP specifications)
UAC	User Agent Client
UAS	User Agent Server
UCS	Universal Character Set
UDP	User Datagram Protocol
UE	User Equipment
UP	User Plane
URI	Uniform Resource Identifier
URL	Uniform Resource Locator
USD	User Specific Dictionary
UTF-8	UCS Transformation Format 8
WPS	Wireless Priority Service
XDM	XML Document Management
XML	Extensible Mark-up Language

4. Introduction

This specification contains the Control Plane procedures for the Push to talk over Cellular (PoC) service on the POC-1, POC-2, POC-10, POC-12 and IP-1 reference points as specified in [OMA-PoC-AD].

The document is structured in the following way:

Clause 5: "*Common procedures*" defines the common procedures and general principles, which are not described in the 3GPP/3GPP2 specifications.

Clause 6: "*Procedures at the PoC Client*" defines the originating and terminating procedures at the PoC Client required to realize these respective features of the PoC service.

Clause 7: "*Procedures at the PoC Server*" defines the originating and terminating procedures at the PoC Server, when it performs Controlling and Participating PoC Functions and the determination of the PoC Server role.

Clause 8: "*PoC Box*" defines the procedures at the NW PoC Box and the UE PoC Box required to realize the PoC Box feature of the PoC service.

Appendix A: "*Static conformance requirements (SCR)*" is a normative annex containing tables of mandatory and optional features.

Appendix B: "*The parameters to be provisioned for PoC service*" is a normative annex for PoC provisioning parameters.

Appendix C: "*Presence Information Elements and Procedures*" is a normative appendix that defines the PoC specific Presence information elements and the Presence procedures, which the PoC functional entities follow in order to perform Presence related actions.

Appendix D: "*Initial Filter Criteria*" is an informative annex to describe with logic examples the originating and terminating Filter Criteria for the IMS to support the PoC functionality.

Appendix E: "*Documentation of SIP, SDP and XML extensions*" is an informative annex to describe the needed extensions in SIP, SDP and XML.

Appendix F: "*Examples of Signalling Flows*" is an informative annex to describe some of the signaling flows.

Appendix G: "*Change History*" describes the document version history.

5. Common procedures

5.1 General

The procedures in this specification are presented in the form of procedural description. The order of the procedural steps can be significant and deviating from the presented order can result in interoperability problems.

All Control Plane signalling requests and responses between the PoC Client and the PoC Server, between the PoC Box and PoC Server, as well as between PoC Servers, SHALL be routed via the SIP/IP Core as specified in [OMA-PoC-AD]. When the SIP/IP Core corresponds to 3GPP/3GPP2 IMS, then the SIP routing procedures are specified in [3GPP TS 24.229] / [3GPP2 X.S0013.4].

5.2 Authenticated Originator's PoC Address

The Authenticated Originator's PoC Address is the PoC Address of the PoC User at the originating or terminating PoC Client that has been validated by the SIP/IP Core or the PoC Group Identity used by the PoC Server performing the Controlling PoC Function when inviting PoC Users to a PoC Group Session.

When the SIP/IP Core corresponds to 3GPP/3GPP2 IMS, then the Authenticated Originator's PoC Address is contained in the P-Asserted-Identity header according to rules and procedures of [3GPP TS 24.229] / [3GPP2 X.S0013.4]. The PoC Client MAY insert a P-Preferred-Identity header, which contains a PoC Client preferred identity, for the SIP/IP Core to use inside the P-Asserted-identity header. If privacy is required, the From header SHALL contain an anonymous URI.

The From header MAY be used to carry the Authenticated Originator's PoC Address, and MAY be supported by the PoC Server. The PoC Server MAY be able to support an Authenticated Originator's PoC Address in the From header if the PoC Server has transitive trust with the SIP/IP Core, and if the SIP/IP Core is able to perform proxy authentication of the PoC Client.

If the PoC Server cannot obtain an Authenticated Originator's PoC Address for an initial request it SHALL reject the request with a SIP 403 "Forbidden" response.

5.3 Signaling compression

If the SIP/IP Core supports SIP signaling compression, the SIP/IP Core SHALL support SigComp, as specified in [RFC3320], [RFC3485] and [RFC3486].

The PoC Client SHOULD compress the SIP signaling according to rules and procedures of [RFC3320], [RFC3485] and [RFC3486] to reduce the transmission delays.

If the PoC Client initiates the signaling compression according to rules and procedures of [RFC3320], [RFC3485] and [RFC3486], then the SIP/IP Core SHALL compress the SIP signaling according to rules and procedures of [RFC3320], [RFC3485] and [RFC3486].

The PoC Client and the SIP/IP Core MAY support stateful compression like dynamic compression, User Specific Dictionaries (USD) or other SigComp extended operations to improve the compression efficiency and to further reduce transmission delays (a definition of dynamic compression, USD and a description of other SigComp extended operations is specified in [RFC3321]).

NOTE: Dynamic compression and USD can be implemented without using the extended operations mechanisms of [RFC3321], which is referenced here in the interest of thoroughness.

5.4 Nick Name

The PoC Server and the PoC Client MAY send Nick Names in SIP requests and SIP responses.

If a PoC Server supports sending of Nick Names in SIP requests and SIP responses the use of Nick Names SHALL be a service provider configuration option, where it is possible to enable or disable the sending of Nick Names.

If PoC Client and PoC Server supports sending of Nick Names, then following applies:

A PoC Client MAY provide the inviting PoC User's Nick Name in the "display-name" part of the Authenticated Originator's PoC Address, i.e. in the P-Preferred-Identity header or, e.g. when the P-Preferred-Identity header is not included, in the From header of the initial SIP INVITE request or SIP REFER request sent towards the PoC Server performing the Participating PoC Function.

NOTE 1: A Nick Name included in the P-Preferred-Identity header is moved to the P-Asserted-Identity header by the underlying SIP/IP Core if validation of the PoC Address is successful as described in [RFC3325]. If validation of the PoC Address fails the SIP/IP Core uses a default PoC Address in the P-Asserted-Identity header and the Nick Name, if included in the P-Preferred-Identity header, is lost. A Nick Name in the From header is never lost.

The PoC Server performing the Participating PoC Function SHALL provide the inviting PoC User's Nick Name in the "display-name" part of the Authenticated Originator's PoC Address in the initial SIP INVITE request before sending the initial SIP INVITE request to the PoC Server performing the Controlling PoC Function. If the Authenticated Originator's PoC Address already includes a Nick Name it SHALL be replaced by the configured Nick Name, if available and if privacy not requested.

NOTE 2: The Nick Name can be configured in the PoC Group definitions in the case of Pre-arranged PoC Group and in the case of Chat PoC Group.

The terminating PoC Client MAY provide the Invited PoC User's Nick Name in the "display-name" part of the To header of the SIP 200 "OK" response to an initial INVITE request sent to the PoC Server performing the Participating PoC Function.

The terminating PoC Client MAY have provided the PoC User's Nick Name in the "display-name" part of the From header of the SIP INVITE request, when Pre-established Session has been established.

The PoC Server performing the Participating PoC Function SHALL provide the Invited PoC User's Nick Name in the "display-name" part of the Authenticated Originator's PoC Address in SIP 200 "OK" responses to initial SIP INVITE requests before sending the SIP 200 "OK" response to the PoC Server performing the Controlling PoC Function. If the Authenticated Originator's PoC Address already includes a Nick Name it SHALL be replaced by the configured Nick Name, if available and if privacy not requested.

In case of more than one identical Nick Name in a PoC Session, the PoC Server MAY make Nick Names unique by using the form of <Nick Name-n> where n is an integer number. For example with Nick Names there can be 'anonymous', 'anonymous-5', 'Batman' and 'Batman-3' in the same PoC Session as all these are unique.

The PoC Server performing the Controlling PoC Function SHALL collect Nick Names, if Nick Names for Participants in a PoC Session are provided, according to the following priority order:

In case that privacy is requested:

- 1. A Nick Name received in the "display-name" part of the From header of an initial SIP request, if included; or,
- 2. A Nick Name received in the "display-name" part of the To header of a SIP 200 "OK" response to an initial SIP request, if included; or,
- 3. A string that is the 'user' part of the Anonymous PoC Address as specified in subclause 5.9 "Anonymous PoC Address" e.g., "Anonymous-5".

In case that privacy is not requested:

- 1. The <display-name> child element of the <entry> element for PoC Users in PoC Group definitions as specified in [OMA-PoC-Document-Mgmt] if <display-name> is defined; or,
- 2. The Nick Names received in the "display-name" part of the Authenticated Originator's PoC Address of initial SIP requests and SIP 200 "OK" responses to the initial SIP requests from Participants; or,
- 3. The Nick Names received in the "display-name" part of the From header of initial SIP requests or in the "display-name" part of the To header of the SIP 200 "OK" responses to the initial SIP requests from Participants.

The PoC Server performing the Controlling PoC Function SHALL include a Nick Name, if a Nick Name is collected as described above, in the Authenticated Originator's PoC Address of the initial SIP INVITE request when inviting a PoC User to a PoC Session.

NOTE 3: The PoC Server performing the Controlling PoC Function uses the Nick Name as part of the Sender Identification as specified in [OMA-POC-UP] "*Sender Identification*", and as part of Participant information as described in subclause 7.2.1.11 "*PoC Session Participant request*".

The PoC Client MAY show the PoC User a locally stored display name in stead of the received Nick Name, if a locally stored display name is available in the User Equipment.

5.5 Error handling

This specification describes PoC specific error procedures but the handling of errors that cannot be regarded as PoC specific SHALL follow the rules and procedures of the relevant specification in subclause 2.1 "*Normative References*".

5.6 Warning header

5.6.1 General

The PoC Server MAY include a free text string in a SIP response to SIP request specified in clause 7 "*Procedures at the PoC Server*".

When the PoC Server includes a text string in a response to a SIP INVITE request the text string SHALL be included in a Warning header as specified in [RFC3261]. The PoC Server SHALL include the Warning code set to 399 and MAY include the host name set to the host name of the PoC Server.

The PoC Client MAY include the preferred language in Accept-Language header in the SIP INVITE request or the SIP 200 "OK" response to the SIP INVITE request.

NOTE: The preferred language can also be used in subsequent SIP transactions of the PoC Session.

The PoC Server SHOULD choose language of the warning text in the Warning-header depending on the preferred language indicated in Accept-Language header received from the PoC Client in the SIP INVITE request or in the SIP response, if the language is supported. If the warning text is to be translated, only explanatory text of the free text string SHALL be replaced by the preferred language.

5.6.2 Warning texts

The text string included in a Warning header consists of an explanatory text preceded by a 3-digit text code, according to the following format <xxx> + <explanatory text>, for example '102 Too many participants'.

Table 1 defines the warning texts that are defined for the Warning header when a Warning header is included in a response to a SIP INVITE request as specified in subclause 5.6.1 "*General*".

Code	Explanatory text	Description
100	Correct Session Type of <Request-URI> is "session=chat"	The Session type uri parameter does not correspond to a Chat PoC Group specified by the SIP URI in the Request-URI of the SIP INVITE request.

		The value of <Request-URI> will depend on the actual request received.
101	Correct Session Type of <Request-URI> is "session=prearranged"	The Session type uri parameter does not correspond to a Pre-arranged PoC Group specified by the SIP URI in the Request-URI of the SIP INVITE request. The value of <Request-URI> will depend on the actual request received.
102	Too many participants	The maximum number of Participants allowed in a PoC Session is exceeded.
103	Too many group members	The PoC Group has more than <max-participant-count> members as specified in [OMA-PoC-Document-Mgmt].
104	Too many Simultaneous PoC Sessions	The maximum number of Simultaneous PoC Sessions for the PoC Client is exceeded.
105	Isfocus already assigned	A conference focus (a PoC Server performing the Controlling Function) has already been assigned to the PoC Session.
106	Isfocus not assigned	A conference focus (a PoC Server performing the Controlling Function) has not been assigned to the PoC Session.
107	Not authorized to add <Media Type>	The offered Media Type is not accepted due to authorization. The value of <Media Type> is 'PoC Speech', 'Audio', 'Video' or 'Discrete Media'.
108	Media content in INVITE discarded	At least one MIME body containing media has been removed from the SIP INVITE request.
109	PoC Box not possible for a Chat PoC Group	Voice mail type PoC Box can't be used for Chat PoC Groups.
110	Dispatch group has already another active dispatcher	The Dispatch PoC Group already has on-going Dispatch PoC Session(s) with another PoC Dispatcher.
111	User not allowed to transfer the dispatcher role	Requesting PoC User not allowed to transfer the PoC Dispatcher role based on the Dispatch PoC Group definition
112	Target User not allowed to receive the dispatcher role	Target PoC User is not defined as PoC Dispatcher capable in the Dispatch PoC Group definition
113	User is not a dispatcher for the group	Requesting PoC User is not defined as PoC Dispatcher capable in the Dispatch PoC Group definition
114	QoE Assignment Error	An error in the assignment of the QoE Profile to the PoC Session has occurred.
115	<RequestedQoE> QoE Profile not authorized	Requested Local QoE Profile is not authorized according to the PoC User subscription. <Requested QoE> will be the Local QoE Profile requested by the inviting PoC User in the initial request or by the Invited PoC User in the final response.
116	PoC Session already exists	Although the PoC Client attempted to initiate a new PoC Session, existing PoC Session was joined instead.
117	Client not supporting the PoC Dispatcher capability	PoC Client is not supporting the PoC Dispatcher capability.
118	Media content not allowed	Added media content in the request is not allowed by PoC Server local policy.
119	Anonymity not allowed	Privacy is requested, but anonymity is not allowed.

120	Routing error in network	The SIP request is routed to a wrong server by the SIP/IP Core.
121	Function not allowed due to <detailed reason>	The function is not allowed to this user. The <detailed reason> will be 'Group definiton', 'Access Policy', 'Local Policy', 'User authorization' or free text string.
122	Function not allowed	Function is not allowed, but the detailed description about the reason is not given.
123	Session does not exist	The target session in the Request URI does not exist NOTE: Used by OMA IM as specified in [OMA_IM_TS_Endorsement] "Warning header".
124	Service not allowed due to the age limit	Service has an age limit and the limit is not reached. NOTE: Used by OMA IM as specified in [OMA_IM_TS_Endorsement] "Warning header".
125	No messages	Messages are retrieved, but the history function has no messages. NOTE: Used by OMA IM as specified in [OMA_IM_TS_Endorsement] "Warning header".
126	Uri-list service not supported	Uri-list service not supported/allowed by the Server. NOTE: Used by OMA IM as specified in [OMA_IM_TS_Endorsement] "Warning header".
127	Service not authorised	The User is not authorised for this service. NOTE: Used by OMA IM as specified in [OMA_IM_TS_Endorsement] "Warning header".
128	Too many embedded groups	PoC Server has found too many embedded groups.
129	No destinations	No destination addresses available for the action.
130	Conflicting URI: <URI>	If the URI Usage Type uri-parameter of an URI in the MIME resource-lists body or in the Refer-to header does not correspond to the actual usage of the URI. <URI> will be the URI including the URI Usage Type uri-parameter.
131	Invalid URI <URI>	The PoC Address received in a SIP PUBLISH request is not registered by this PoC Client. The reason could be that a race condition has occurred between the SIP/IP Core and the PoC Network. Retransmitting the SIP PUBLISH request can give a different result.

Table 1: PoC specific warning texts

5.6.3 Warning text code numbers

Code numbers 000 – 999 are reserved for use in warning texts within PoC.

NOTE: Vendor-specific warning text is sent without warning text code.

5.7 PoC Session Identity

The PoC Session Identity is a SIP URI, which SHALL identify the PoC Session.

The PoC Server performing Controlling PoC Function SHALL allocate a unique PoC Session Identity for the PoC Session when established.

The PoC Server performing the Participating PoC Function MAY re-construct the PoC Session Identity based on the SIP URI received from the Controlling PoC Function during PoC Session establishment as described in the subclause 7.3.2.1 "General".

The PoC Session Identity identifies the PoC Session the in way that e.g.:

- the PoC User is able to leave a PoC Session;
- the PoC User is able to add PoC Users to an on-going PoC Session;
- the PoC User is able to subscribe the Participant information of the on-going PoC Session;
- the PoC User is able to re-join the PoC Session as long as the PoC Session is on-going in the PoC Server performing the Controlling PoC Function also in the case that his Home PoC Server is not anymore participating the PoC Session; and,
- the SIP/IP Cores are able to route an initial SIP request to the PoC Server performing the Controlling PoC Function.

NOTE: The exact format of the PoC Session Identity allocated by the PoC Server depends on the functionality of the SIP/IP Core in this PoC Network.

The PoC Server performing Controlling PoC Function SHALL send the PoC Session Identity towards the PoC Client during the PoC Session establishment in the Contact header.

The PoC Server performing Participating PoC Function SHALL send the PoC Session Identity to the PoC Client in the MBCP Connect message if Pre-established Session is used.

5.7A PoC Session association

A PoC Client MAY support multiple PoC Addresses and be involved in one or more PoC Sessions at the same time using the same or different PoC Addresses.

If the PoC Client supports multiple PoC Addresses and if an Instance Identifier URN is available and used by the PoC Client the PoC Client:

- 1. SHALL include in the Contact header of the SIP REGISTER request a '+sip.instance' feature tag with the Instance Identifier URN as specified in [sip-outbound] when registering to the PoC Service;
- 2. SHALL include in the Contact header of PoC specific SIP requests and SIP responses a '+sip.instance' feature tag with the Instance Identifier URN as specified in [sip-outbound]; and,
- 3. SHALL include the Instance Identifier URN as the <entity> element 'id' attribute in PoC Service Settings.

NOTE 1: If a '+sip.instance' feature tag is not included in the Contact header or in the <entity> 'id' attribute in the PoC Service Settings, the PoC Server handles this as if an Instance Identifier URN with the zero length value was included.

The PoC Server SHALL subscribe to the "reg" event package according to rules and procedures of [RFC3265] and [RFC3680].

Upon receiving the SIP NOTIFY request as the result of the subscription to the "reg" event package the PoC Server:

- 1. SHALL if the state of the <contact> element is "created", "registered", "refreshed"
 - a) cache, for each combination of a PoC address received in the <aor> element and the Instance Identifier URN included in the <unknown-param> element with 'name' attribute equal to '+sip.instance' all PoC Addresses registered by the same Instance Identifier URN so that the PoC Server can retrieve the list of PoC Addresses used by the same PoC Client by using the PoC Address and the Instance Identifier URN as the key to the cached information; and,
 - b) cache, for each PoC Address received in the <aor>, the PoC Addresses and the Instance Identifier URN included in the <unknown-param> element with 'name' attribute equal to '+sip.instance' that are registered together at a PoC Client so that the PoC Server can retrieve the list of PoC Addresses registered together by the same PoC Client using a PoC Address as the key to the cached information.

NOTE 2: The PoC Server caches the information with two keys in order to handle SIP requests and SIP responses from the PoC Client and the SIP INVITE request from the PoC Server performing the Controlling PoC Function differently.

NOTE 3: If an <unknown-param> with a 'name' attribute equal to '+sip.instance' is not included the PoC Server handles this as if an Instance Identifier URN with the zero length value was received.

- 2. SHALL if the state of the <contact> element is set to "expired", "deactivated", "probation", "unregistered" or "rejected":
 - a) remove, for each combination of a PoC address received in an <aor> element and the Instance Identifier URN included in the <unknown-param> element with 'name' attribute equal to '+sip.instance', the cached list of PoC Addresses using the PoC Address and the Instance Identifier URN as the key to the cached information; and,
 - b) remove, for each PoC Address received in the <aor>, the cached list of PoC Addresses using the PoC Address in the <aor> as the key to the cached information.
- Upon receiving the SIP PUBLISH request with the PoC Service settings the PoC Server: 1. SHALL return a SIP 500 "Server Internal Error" response with the warning text set to '131 Invalid URI <URI>' as specified in subclause 5.6 "Warning header" if there is no list of PoC Addresses cached using the Authenticated Originator's PoC Address and the Instance Identifier URN in the <entity> 'id' attribute as the key. Otherwise continue with the next step;

NOTE 4: If the <entity> 'id' attribute does not include an Instance Identifier URN the PoC Server handles this as if an Instance Identifier URN with the zero length value was received.

- 2. SHALL cache the PoC Service Settings using the PoC Address and the Instance Identifier URN as the key to the cached information.

Upon receiving PoC specific SIP requests and SIP responses from PoC Client the PoC Server performing the Participating PoC Function:

- 1. SHALL retrieve the cached list of PoC Addresses using the Instance Identifier URN retrieved from the Contact header and the Authenticated Originator's PoC Address as the key to the cached information; and,
- 2. SHALL apply the QoE specific and Simultaneous PoC Session procedures specified in the subclause 7.3 "Participating PoC Function procedures" and in [OMA-PoC-UP] "Procedures at the PoC Server performing the Participating PoC Function" for each PoC Session involving a PoC Address in the retrieved list and the Instance Identifier URN in the Contact header.

NOTE 5: If the Contact header does not include a '+sip.instance' feature tag with an Instance Identifier URN the PoC Server handles this as if an Instance Identifier URN with the zero length value was received.

Upon receiving an initial SIP INVITE request from the PoC Server performing the Controlling PoC Function, the PoC Server performing the Participating PoC Function:

- 1. SHALL retrieve the list of PoC Addresses using the PoC Address in the Request URI as the key to the cached information; and,
- 2. SHALL apply the QoE specific and Simultaneous PoC Session procedures specified in the subclause 7.3 "Participating PoC Function procedures" and in [OMA-PoC-UP] "Procedures at the PoC Server performing the Participating PoC Function" for each PoC Session involving a PoC Address in the list and the Instance Identifier URN in the Contact header.

5.8 QoE Profiles

5.8.1 General

Four QoE Profiles are defined as follows, from lower to higher priority level: 'Basic', 'Premium', 'Professional', and 'Official Government Use' as specified in [OMA-PoC-SD] "Quality of Experience (QoE)".

PoC Clients SHOULD and PoC Servers SHALL support the use of QoE Profiles.

QoE Profiles are part of the PoC User subscription (i.e: a QoE Profile is considered within the PoC User subscription) and, therefore, the PoC User SHALL be authorized to use the subscribed QoE Profile as well as any lower QoE Profile. How the PoC Server checks that a PoC User is authorized to use a QoE Profile is out of the scope of this specification.

The use of QoE Profiles in PoC Servers is optional for the PoC Service Provider. If the Service Provider does not enable the use of QoE Profiles, the PoC Server SHALL ignore the received QoE information.

If the Service Provider enables the use of QoE Profiles, the following applies:

- Each PoC Session SHALL be assigned a QoE Profile by the Controlling PoC Function and each PoC User participating in a PoC Session SHALL apply a Local QoE Profile that depends on the QoE Profile of the PoC Session and his own subscription. In order to convey information about QoE Profiles between PoC Servers and PoC Clients, an SDP attribute is used as specified in subclause E.3.2 "QoE Profile". This QoE Profile attribute is included in SDP offers or SDP answers, contained in some SIP requests or SIP responses.
- A PoC Server performing the Participating PoC Function in the terminating PoC Network SHALL behave as B2BUA.
- Each QoE Profile maps to a specific set of QoS parameters. The QoE Profiles that are authorized for a given PoC User and their associated QoS parameters SHALL be provisioned to the PoC Client as specified in subclause A.3.1 "OMA PoC Management Object Tree". These QoS parameters SHOULD be used by the PoC Client when reserving resources at the underlying network, depending on the Local QoE Profile applied by the PoC Client for the PoC Session. This mechanism aims at getting common or similar QoS characteristics for all the Participants of the PoC Session.

A PoC Group MAY have an associated QoE Profile defined in the <qoe> element of the PoC Group document as specified in [OMA-PoC-Document-Mgmt]. When the <qoe> element is defined for a PoC Group, the QoE Profile assigned to a PoC Session established with that PoC Group SHALL be the QoE Profile defined in the <qoe> element of the PoC Group document.

5.8.2 The 'Official Government Use' QoE Profile

PoC Servers and PoC Clients MAY Support the 'Official Government Use' QoE Profile. If supported the 'Official Government Use' QoE Profile relies on the use of the Resource-Priority header together with the "WPS" namespace, as specified in [RFC4412]. If not supported, the PoC Server SHALL ignore the received QoE information.

The WPS namespace defines 5 levels of priority, which are numbered from 0 to 4, where 4 is the lowest and 0 is the highest priority level.

When the 'Official Government Use' QoE Profile is used for PoC Session or Pre-established Session establishment or modification procedures, a Resource-Priority header SHALL be included according to rules and procedures of [RFC4412]

along with the SDP QoE Profile attribute in the appropriate SIP requests or SIP responses. Exhaustive analysis of the appropriate SIP requests or SIP responses in which the Resource-Priority header will be included is made across this specification; further, the Resource-Priority header SHALL be included according to rules and procedures of [RFC4412] in the following SIP request:

- SIP ACK requests in response to the receipt of a SIP 200 "OK" response to an initial SIP INVITE request containing a Resource-Priority header; in this case the Resource-Priority header SHALL be equal to the one included in the initial SIP INVITE request.

For procedures that do not involve PoC Session or Pre-established Session establishment or modification, the Resource-Priority header, but not the SDP QoE Profile attribute, is used to request 'Official Government Use' priority treatment.

NOTE: SIP/IP Core is expected to support the Resource-Priority header.

5.8.3 Priority and pre-emption

PoC Servers and PoC Clients MAY support the prioritization and pre-emption capability. The Controlling PoC Function SHOULD directly determine the PoC Session Precedence from the QoE Profile assigned for the PoC Session, as defined by the PoC Service Provider. If this capability is supported, then under high load situations the PoC Server:

- SHALL prioritise the signalling of PoC Sessions using the 'Official Government Use' QoE Profile among the signalling of other PoC Sessions with lower QoE Profile. Between PoC Sessions using 'Official Government Use' QoE Profile, the PoC Server SHALL prioritize the signalling depending on the WPS priority level being used by each PoC Session, according to the rules and procedures of [RFC4412];
- SHOULD prioritise the Media flows of PoC Sessions with higher PoC Session Precedence over Media flows of PoC Sessions with lower PoC Session Precedence;
- When performing the Controlling PoC Function, the PoC Server MAY revoke the Media Burst sending permissions, or reject the Media Burst requests, of PoC Clients participating in PoC Sessions with lower PoC Session Precedence. To carry out this actions, the PoC Server SHALL interact with the User Plane as specified in [OMA-PoC-UP] "*PoC Server state transition diagram for general Media Burst operation*";
- When performing the Controlling PoC Function, the PoC Server MAY release, as specified in subclause 7.2.1.16 "*PoC Session release policy*", PoC Sessions with lower PoC Session Precedence due to the requests of establishment of PoC Sessions of a higher PoC Session Precedence.

5.9 Anonymous PoC Address

When a PoC User requests privacy, the PoC Server performing the Controlling PoC Function creates an Anonymous PoC Address for the PoC User. In addition to anonymity, the PoC Addresses are also unique in a PoC Session. The PoC Server SHALL support Anonymous PoC Addresses. When receiving a SIP request or a SIP response with privacy requested, the PoC Server performing the Controlling PoC Function SHALL create an Anonymous PoC Address of the form <sip:anonymous@anonymous.invalid>. If PoC Server supports Nick Names, and if the Nick Name (see subclause 5.4 "*Nick Name*") is received in a SIP request or SIP response, the PoC Server SHALL use it as a Nick Name. If Nick Name is not received in a SIP request or SIP response, the PoC Server MAY use the 'user' part of the Anonymous PoC Address as a Nick Name.

In addition to anonymity, the Anonymous PoC Addresses SHALL be unique within PoC Session. If Nick Names are supported and used, the PoC Server allocated Nick Names of Anonymous PoC Addresses SHALL also be unique in a PoC Session and the PoC User given Nick Names MAY be unique in the PoC Session. In case of more than one Anonymous PoC Addresses are used in the same PoC Session, for the second Anonymous PoC Session and thereafter, the PoC Server SHALL use the form <sip:anonymous-n@anonymous.invalid> where n is an integer number.

NOTE: The PoC Client can find out the Anonymous PoC Addresses of the Participants who requested to be anonymous by subscribing to the Participant information.

5.10 PoC Speech

PoC Speech SHALL be offered either with the Talk Burst Control Protocol or with the Media Burst Control Protocol. PoC Speech Media SHALL exist at most once in the SDP offer.

When PoC Speech is offered with TBCP one "m=audio" line SHALL be included in the SDP without the "a=label" attribute.

When PoC Speech is offered with MBCP one "m=audio" line SHALL be included in the SDP with the "a=label" attribute with a unique value as specified in [RFC4574] and a "i=" field associated with the "m=audio" line set to "speech" as specified in [RFC4566].

NOTE: The procedure does not allow for any negotiation which means that the sender of an offer decides which Media Stream that is regarded as PoC Speech.

5.11 Implicit Media Burst request

An initial SIP INVITE request or a SIP REFER request fulfilling one of the following criteria SHALL be regarded as received with an Implicit Media Burst request when the PoC Client

1. is initiating a PoC Session other than a Chat PoC Group Session and only PoC Speech is bound to the Media-floor Control Entity; or,
2. attempts to initiate a PoC Session and the PoC Session is already ongoing and the PoC Session is different from a Chat PoC Group Session and only PoC Speech is bound to the Media-floor Control Entity; or,
3. includes the 'imp_mb_req' parameter in the SDP offer/answer as specified in subclause E.3.1 "*Media Burst Control Protocol MIME registration*" with the value of 1.

In all other cases the SIP INVITE request or the SIP REFER request SHALL be regarded as received without an Implicit Media Burst request.

When the received SIP INVITE request or the SIP REFER request is regarded as an Implicit Media Burst request the PoC Server performing the Controlling PoC Function SHALL send a response to the PoC Client as specified in the [OMA-PoC-UP] "*Media Burst Control*".

NOTE: The response can be a MBCP message or the 'tb_granted' parameter set to 1 included in the SDP answer as specified in E.3.1 "*Media Burst Control Protocol MIME registration*".

5.12 Stay on the Media path

The PoC Server performing the Participating PoC Function SHALL behave as a B2BUA according to rules and procedures of [RFC3261] for the duration of the PoC Session, when staying on the Media path.

The PoC Server performing the Participating PoC Function MAY indicate the B2BUA behaviour to the PoC Server performing the Controlling PoC Function using the b2bua uri-parameter as specified in subclause E.5.3 "*Back to back UA uri-parameter*" and SHALL insert the "b2bua" to the URI of the PoC Server in the Contact header of the SIP INVITE request or the SIP response to the SIP INVITE request, if the PoC Server performing Participating PoC Function indicates according to the local policy to the Controlling PoC Function, that it acts as a B2BUA and stays on the Media path.

The PoC Server performing the Controlling PoC Function SHALL cache the B2BUA indications, if it is provided by the PoC Servers performing the Participating PoC Functions.

The PoC Client and the PoC Box SHALL NOT include the 'b2bua' uri-parameter to the Contact header of the SIP INVITE request or the SIP response to the SIP INVITE request.

If the 'b2bua' uri-parameter is included in the Contact header of the SIP INVITE request or the SIP response to the SIP INVITE request received from the PoC Client or the PoC Box, the PoC Server SHALL reject or release the PoC Session being established.

6. Procedures at the PoC Client

6.1 PoC Client originating procedures

6.1a Backward compatibility

When PoC Client is configured according to the parameters specified in [OMA-PoC1.0-CP] "*The parameters to be provisioned for PoC service*" the PoC Client SHALL perform procedures specified in [OMA-PoC-1-CP] "*Procedures at the PoC Client*" instead of the procedures specified in this document.

NOTE: OMA PoC 1 CP doesn't specify how to handle the PoC 2 specific PoC Service Settings.

6.1.1 PoC service registration

6.1.1.1 PoC service registration and re-registration

The PoC Client PoC service registration and re-registration to the SIP/IP Core SHALL be made according to rules and procedures of [RFC3261] with the clarifications in this subclause.

When registering or re-registering for the PoC service, the PoC Client

- 1. SHALL generate a SIP REGISTER request according to rules and procedures of [RFC3261];
- 2. SHALL include the PoC feature tag '+g.poc.talkburst' in the Contact header of the SIP REGISTER request that contains the contact address of the PoC Client;
- 3. SHALL include the PoC feature tag '+g.poc.dispatcher' in the Contact header of the SIP REGISTER request that contains the contact address of the PoC Client, if the PoC Dispatcher capability is supported;
- 4. SHALL include the PoC feature tag '+g.poc.groupad' in the Contact header of the SIP REGISTER request that contains the contact address of the PoC Client, if receiving of Group Advertisement messages is supported;
- 5. SHALL include the PoC feature tag '+g.poc.discretedia' in the Contact header of the SIP REGISTER request that contains the contact address of the PoC Client, if Discrete Media is supported;
- 6. SHALL include the PoC feature tag '+g.poc.fdcfo' in the Contact header of the SIP REGISTER request that contains the contact address of the PoC Client, if the FDCFO Proceed feature is supported;
- 7. SHOULD include the parameter 'q' with value between 1 and 0 in the Contact header of the SIP REGISTER request that contains the contact address of the PoC Client if UE PoC Box functionality is supported by the UE and enabled by the PoC User.
- 8. SHALL include an additional Contact header containing the contact address of the UE PoC Box and the feature tags 'sip.automata' and 'sip.actor' with the value 'principal' and 'sip.description' with the value "poc recording device" and the PoC feature tag '+g.poc.talkburst' along with the parameter 'q' with value between 1 and 0 if UE PoC Box functionality is supported by the UE and enabled by the PoC User;

NOTE 1: The value of parameter 'q' for the UE PoC Box and the PoC Client Contacts cannot be the same as this would result in parallel forking of the request.

NOTE 2: If the value of parameter 'q' for the PoC Client Contact header is greater than the value of parameter 'q' included in the UE PoC Box Contact header then requests not containing an Accept-Contact header indicating the UE PoC Box will be routed to the PoC Client.

NOTE 3: If the value of parameter 'q' for the PoC Client Contact header is less than the value of parameter 'q' included in the UE PoC Box Contact header then requests not containing a Reject-Contact header for the UE PoC Box will be routed to the UE PoC Box. Equivalent functionality can be achieved by the PoC Client implementation redirecting locally the PoC Session invitation to the UE PoC Box.

NOTE 4: The use of a higher value of parameter 'q' for the UE PoC Box Contact than the PoC Client Contact achieves similar functionality for the UE PoC Box as the use of the SIP 302 "Moved Temporarily" response achieves for the NW PoC Box.

NOTE 5: If the SIP/IP Core corresponds to 3GPP IMS then every contact address in the Contact header has to contain the same IP address and port number however they can contain different tokens as URI parameters to differentiate them. 3GPP2 IMS allows additional security mechanisms to be used (e.g TLS and HTTP Digest) as well as the security mechanism specified by 3GPP. Some 3GPP2 security mechanisms do not restrict the UE to use the same IP address and port number for all contact addresses.

- 9. SHALL include an Instance Identifier URN in each added Contact header as specified in subclause 5.7A "*PoC Session association*" if the PoC Client supports multiple PoC Addresses and if an Instance Identifier URN is available and used by the PoC Client or, if the PoC Client supports NAT traversal and when the PoC Client is behind NAT.
- 10. SHALL include a Require header with the option tag 'pref' according to rules and procedures of [RFC3840];
- 11. MAY include the User-Agent header in the SIP REGISTER request to indicate the OMA PoC release version of the PoC Client as specified in subclause E.4.1 "*Release version in User-agent and Server headers*";
- 12. SHALL insert in the SIP REGISTER request any necessary security parameters (e.g. Digest response) according to rules and procedures of the SIP/IP Core;
- 13. SHOULD include a Resource-Priority header according to rules and procedures of [RFC4412], if the PoC Client supports 'Official Government Use' QoE Profile and the PoC User requests the priority treatment of the QoE Profile. If included, the value of the Resource-Priority header SHALL be equal to the level of priority assigned to the PoC User, as specified in subclause 5.8 "*QoE Profiles*"; and,
- 14. SHALL send the SIP REGISTER request towards the SIP/IP Core according to rules and procedures of the SIP/IP Core.

NOTE 7: The UAC can register clients for several enablers using the same SIP REGISTER request. In case other enabler client(s) are already registered and a new enabler client is registering, the UAC includes in the SIP REGISTER request also the feature tag(s) with which the other enablers are currently registered.

Each time the PoC Client has successfully performed an initial PoC service registration the PoC Client SHALL set the PoC Service Setting as specified in subclause 6.1.2 "*PoC Service Settings procedure*".

NOTE 8: The SIP/IP Core may challenge and authenticate the SIP REGISTER request requiring the resending of the SIP REGISTER request with authentication credentials.

The PoC Client SHALL send NAT keep-alive messages as specified in [sip-outbound] when the PoC Client is behind Network Address Translators (NAT) if NAT traversal is supported by the PoC Client.

NOTE 9: Periodic application level re-registration is initiated by the PoC Client to refresh an existing registration based on the re-registration requirements of the SIP/IP Core.

When the SIP/IP Core corresponds to 3GPP/3GPP2 IMS the PoC Client SHALL use 3GPP/3GPP2 IMS registration mechanisms according to rules and procedures of [3GPP TS 24.229] / [3GPP2 X.S0013.4] with the clarifications given in this subclause.

6.1.1.2 PoC service de-registration

When de-registering from the PoC service, the PoC Client SHALL de-register to the SIP/IP Core according to rules and procedures of [RFC3261] with the clarifications in the following.

When PoC service de-registering, the PoC Client:

- 1. SHALL remove the PoC Service Settings before de-registering from the PoC service as specified in subclause 6.1.2 "*PoC Service Settings procedure*".

- 2. SHALL generate a SIP REGISTER request;
- 3. SHALL NOT include the PoC feature tag '+g.poc.talkburst' in the Contact header of the SIP REGISTER request that contains the contact address of the PoC Client;
- 4. SHALL include the PoC feature tag '+g.poc.groupad' in the Contact header of the SIP REGISTER request if the PoC Client needs to continue to receive Group Advertisement messages;
- 5. SHALL include a Contact header containing the contact address of the UE PoC Box and the feature tags 'sip.automata' and 'sip.actor' with the value 'principal' and 'sip.description' with the value "poc recording device" and the PoC feature tag '+g.poc.talkburst' if UE PoC Box functionality is supported by the UE and the PoC User needs the UE to continue to act as a UE PoC Box;
- 6. SHALL include an Instance Identifier URN as specified in subclause 5.7A "*PoC Session association*" if the PoC Client supports multiple PoC Addresses and if an Instance Identifier URN is available and used by the PoC Client or the PoC Client supports NAT traversal and if the PoC Client needs to continue to receive Group Advertisement messages or the PoC Client supports NAT traversal and if the PoC Client needs to continue to receive Group Advertisement messages or continue to act as a UE PoC Box,;
- 7. SHALL include a Require header with the option tag 'pref ' according to rules and procedures of [RFC3840], if the PoC Client needs to continue to receive Group Advertisement messages or need to continue to act as a UE PoC Box and MAY include a Require header with the option tag 'pref ' according to rules and procedures of [RFC3840] in all other cases;
- 8. MAY include the User-Agent header in the SIP REGISTER request to indicate the OMA PoC release version of the PoC Client as specified in subclause E.4.1 "*Release version in User-agent and Server headers*";
- 9. SHALL include the expiration value set to 0 according to rules and procedures of [RFC3261], if the User Equipment also needs to de-register from the SIP/IP Core; and,
- 10. SHALL send the SIP REGISTER request towards the SIP/IP Core according to rules and procedures of the SIP/IP Core.

NOTE 1: In case several enabler clients are registered from the same UE, the UAC needs to ensure that it only deregisters the PoC Client and maintains all other enabler clients in the registered state unless the User intends those other clients also to be de-registered. To prevent complete de-registration of all registered enabler clients the SIP REGISTER request does not include an Expires header set to 0 but is a refresh registration without the relevant PoC enabler feature tags (e.g +g.poc.talkburst).

The PoC Client SHALL send NAT keep-alive messages as specified in [sip-outbound] when the PoC Client is behind Network Address Translators (NAT) if NAT traversal is supported by the PoC Client if the PoC Client needs to continue to receive Group Advertisement messages or if UE PoC Box functionality is supported by the UE and the PoC User needs the UE to continue to act as a UE PoC Box.

NOTE 2: Periodic application level re-registration is initiated by the PoC Client to refresh an existing registration based on the re-registration requirements of the SIP/IP Core.

When NAT traversal is supported by the PoC Client and when the PoC Client is behind NAT registration is done according to the procedures in this subclause and according to rules and procedures of [sip-outbound] if the PoC Client needs to continue to receive Group Advertisement messages or if UE PoC Box functionality is supported by the UE or the PoC User needs the UE to continue to act as a UE PoC Box.

When the SIP/IP Core corresponds to 3GPP/3GPP2 IMS the PoC Client SHALL use 3GPP/3GPP2 IMS registration mechanisms according to rules and procedures of [3GPP TS 24.229] / [3GPP2 X.S0013.4] with the clarifications given in this subclause.

6.1.2 PoC Service Settings procedure

To set, update, remove or refresh the PoC Service Settings, the PoC Client:

- 1. SHALL generate a SIP PUBLISH request according to rules and procedures of [RFC3903] and [RFC4354];
- 2. SHALL set the Request-URI of the SIP PUBLISH request to the PoC Address of the PoC User;

- 3. SHALL include the PoC Address of the PoC User as the Authenticated Originator's PoC Address as specified in subclause 5.2 "*Authenticated Originator's PoC Address*";
- 4. SHALL include an Accept-Contact header with the PoC feature tag '+g.poc.talkburst' along with 'require' and 'explicit' parameters according to rules and procedures of [RFC3841];
- 5. SHALL include a User-Agent header to indicate the OMA PoC release version of the PoC Client as specified in subclause E.4.1 "*Release version in User-agent and Server headers*";
- 6. SHALL set the Event header to the value 'poc-settings';
- 7. MAY set PoC Service Settings expiration timer in Expires header, if set, SHALL set according to rules and procedures of [RFC3903], in the same range as the registration timer recommended by SIP/IP Core;

NOTE 1: Expiration timer value 0 means removal of the PoC Service Settings.

- 8. SHALL include the PoC Service Settings as follows, if setting or updating the PoC Service Setting:
 - a) Answer Mode Indication setting (auto-answer or manual-answer);
 - b) Incoming PoC Session Barring setting (ISB active or ISB not active);
 - c) Incoming Instant Personal Alert Barring setting (IAB active or IAB not active); and,
 - d) Simultaneous PoC Sessions Support setting (SSS active or SSS not active).
- 9. MAY include the following optional PoC Service Settings, if setting or updating the PoC Service Setting:
 - a) Invited Parties Identity Information Mode setting ('true' or 'false');
 - b) Included Media Content in a Request Support setting ('true' or 'false');
 - c) Referenced Media Content in a Request Support setting ('true' or 'false');
 - d) Text Content in a Request Support setting ('true' or 'false');
 - e) PoC Box use setting ('unwilling' or 'unconditional' or 'conditional'); and,
 - f) Privacy setting ('none' or 'id').
- 10. SHALL include an Instance Identifier URN in each added Contact header as specified in subclause 5.7A "*PoC Session association*";
- 11. SHOULD include a Resource-Priority header according to rules and procedures of [RFC4412], if the PoC Client subscribes to the 'Official Government Use' QoE Profile. If included, the value of the Resource-Priority header SHALL be equal to the level of priority assigned to the PoC User according to their subscription, as specified in subclause 5.8 "*QoE Profiles*"; and,
- 12. SHALL send the SIP PUBLISH request according to rules and procedures of SIP/IP Core.

On receiving the SIP 200 "OK" response to the SIP PUBLISH request the PoC Client MAY indicate to the PoC User the successful communication of the PoC Service Settings to the PoC Server.

NOTE 2: If a SIP 500 "Server Internal Error" response with the warning text set to '131 Invalid URI <URI>' as specified in subclause 5.6 "*Warning header*" is received as the response to the SIP PUBLISH request, an immediate retransmission of the SIP PUBLISH request or a retransmission of the SIP PUBLISH request according to the value of the Retry-After header field can give a different result.

When the SIP/IP Core corresponds to 3GPP/3GPP2 IMS, the PoC Client SHALL use 3GPP/3GPP2 IMS mechanisms according to rules and procedures of [3GPP TS 24.229] / [3GPP2 X.S0013.4] with the clarifications given in this subclause.

6.1.3 PoC Session initiation

6.1.3.1 General

NOTE 1: This subclause provides common procedures for other subclauses and is not meant to be applied unless referenced.

The PoC Client SHALL generate an initial SIP request according to rules and procedures of [RFC3261]. The PoC Client:

- 1. SHALL include an Accept-Contact header with the PoC feature tag '+g.poc.talkburst' along with 'require' and 'explicit' parameters according to rules and procedures of [RFC3841] in all initial SIP requests;
- 2. SHALL include a User-Agent header to indicate the OMA PoC release version of the PoC Client as specified in subclause E.4.1 "*Release version in User-agent and Server headers*";
- 3. SHALL include the PoC feature tag '+g.poc.talkburst' in the Contact header;
- 4. SHALL include the PoC feature tag '+g.poc.fdcfo' in the Contact header if the FDCFO Proceed feature is supported;
- 5. SHALL include the PoC feature tag '+g.poc.discretedia' in the Contact header, if Discrete Media is supported and acceptable to the PoC User during the PoC Session;
- 6. SHOULD include an Allow header with the SIP methods supported in this SIP dialog according to rules and procedures of [RFC3261];
- 7. SHALL include the PoC Address of the PoC User as the Authenticated Originator's PoC Address as specified in subclause 5.2 "*Authenticated Originator's PoC Address*";
- 8. MAY include a Nick Name in the Authenticated Originator's PoC Address and, if included, the Nick Name SHALL be included as specified in subclause 5.4 "*Nick Name*".

The PoC Client SHALL generate an initial SIP INVITE request according to rules and procedures of [RFC3261]. The PoC Client:

- 1. SHALL include the option tag 'timer' in the Supported header;
- 2. SHOULD include the Session-Expires header according to rules and procedures of [RFC4028], "*Generating an Initial Session Refresh Request*". It is RECOMMENDED that the refresher parameter is omitted. If included, the refresher parameter SHALL be set to 'uac';
- 3. SHALL include an Accept-Language header to indicate the language to be used by the PoC Server for the warning texts sent to the PoC Client if the PoC Client wishes to get the warning texts in a language different than default;

NOTE 2: The use of the option tag 'precondition', as specified in [RFC3312], and the option tag '100rel', as specified in [RFC3262], is not defined for POC-1 reference point.

- 4. SHOULD include a Resource-Priority header according to rules and procedures of [RFC4412], if the PoC Client supports 'Official Government Use' QoE Profile and the PoC User requests that QoE Profile. If included, the value of the Resource-Priority header SHALL be equal to the level of priority assigned to the PoC User, as specified in subclause 5.8 "*QoE Profiles*";
- 5. MAY include media content in one or more MIME bodies as specified in [RFC2046] with a total size equal to or less than the maximum size indicated in "INCLUDED-MEDIA-CONTENT-SIZE";

NOTE 3: If "INCLUDED-MEDIA-CONTENT-SIZE" is not provisioned or if "INCLUDED-MEDIA-CONTENT-SIZE" is provisioned and set to zero a MIME body with a Media Type specified in [RFC2046] can not be included.

- 6. MAY include text content in Subject header in SIP INVITE request as specified in [RFC3261] with a total size equal to or less than the maximum size indicated in "INCLUDED-TEXT-CONTENT-SIZE"; and,

NOTE 4: If "INCLUDED-TEXT-CONTENT-SIZE" is not provisioned or if "INCLUDED-TEXT-CONTENT-SIZE" is provisioned and set to zero text content as specified in [RFC3261] can not be included.

- 7. MAY include reference to media content in the Alert-Info header or in the Call-Info header or both in SIP INVITE request according to rules and procedures in [RFC3261].

NOTE 5: Included Media Content is not applicable, when establishing a Pre-established Session as specified in subclause 6.1.3.2.1 "*PoC Client initiates a Pre-established Session*" or when joining to a Chat PoC Group Session as specified in subclause 6.1.3.3.2 "*PoC Client initiates a Pre-arranged PoC Group Session or joins a Chat PoC Group Session*".

On receipt of a SIP final response or SIP provisional response to the SIP request, the PoC Client:

- 1. SHALL cache the list of SIP methods that the PoC Server supports if received in the Allow header;
- 2. SHALL cache the contact if received in the Contact header; and,
- 3. MAY present the warning text received in a Warning header to the PoC User, if a Warning header is received.

On receipt of the SIP 200 "OK" response to the initial SIP INVITE request the PoC Client:

- 1. SHALL start the SIP Session timer using the value received in the Session-Expires header according to rules and procedures of [RFC4028], "*Processing a 2xx Response*";
- 2. SHALL use the accepted Media Stream and the connected Media-floor Control Entities until the PoC Session is modified or released;
- 3. MAY present the warning text received in a Warning header to the PoC User, if a Warning header is received; and,

NOTE 6: The PoC Client can perform any further actions associated with the SIP/IP Core and Access Network outside the scope of this Specification in accordance with the requested priority procedures of the invitation, if the PoC Client included a Resource-Priority header.

- 4. SHOULD inform the PoC Server performing the Controlling PoC Function, as specified in section 6.1.4.4 "*User Plane Adaptation*", of the achieved QoE Profile, if a QoE Profile was negotiated and if the PoC Client is unable to obtain that negotiated QoE Profile according to the parameters provisioned to the PoC Client, as specified in subclause 5.8 "*QoE Profiles*".

When NAT traversal is supported by the PoC Client and when the PoC Client is behind NAT generation of SIP requests is done as specified in this subclause and as specified in [sip-outbound].

When the SIP/IP Core corresponds to 3GPP/3GPP2 IMS, the PoC Client SHALL use 3GPP/3GPP2 IMS Session establishment mechanisms according to rules and procedures of [3GPP TS 24.229] / [3GPP2 X.S0013.4] with the clarifications given in this subclause.

6.1.3.1a SDP offer generation

For a PoC Session one or more Media Types MAY be offered. The offered Media Streams MAY be of PoC Speech, Audio, Video and Discrete Media. Media Streams for a PoC Session are offered with an SDP body, each independent Media Stream of offered Media Type represented by its own media-level section also known as m-line. One PoC Session MAY include one or more Media-floor Control Entities.

When generating an SDP offer for the PoC Session re-join, the PoC Client SHALL compose the SDP offer as in case of PoC Session initiation.

NOTE 1: The PoC Client can determine the Media Types currently used in the PoC Session as specified in subclause 6.1.10 "*PoC Client subscription to the conference state event package*" or the PoC Client can use the same or subset of the Media Types negotiated in the previous PoC Session invitation.

When the PoC Client generates the SDP offer for the SIP Session refresh using SIP re-INVITE request, the PoC Client SHALL offer the currently used Media Streams with used Media Parameters according to rules and procedures of [RFC3264].

When the PoC Client establishes a Pre-established Session, the PoC Client SHALL compose the SDP offer as in case of PoC Session initiation. In the SDP offer, the PoC Client MAY include one or more Media Types and one or more Media-floor Control Entities.

When the PoC Client requests User Plane adaptation, the PoC Client SHALL offer the used Media Streams with modified Media Parameters according to rules and procedures of [RFC3264].

When the PoC Client generates SDP offer for placing media off hold or placing media on hold, the PoC Client SHALL offer the used Media Stream with used Media Parameters according to rules and procedures of [RFC3264].

When the PoC Client offers to add new Media Type to the PoC Session or to connect to a Media Type in the PoC Session, the PoC Client SHALL offer the Media Type according to rules and procedures of [RFC3264].

NOTE 2: The PoC Client is not necessarily authorized to add a Media Type to the existing PoC Session

When the PoC Client offers to disconnect from a Media Type in the PoC Session, the PoC Client SHALL mark the Media Stream as rejected according to rules and procedures of [RFC3264].

The PoC Client MAY offer to add a new MediaType, to connect to a Media Type and to disconnect from a Media Stream in the PoC Session in the same SIP request.

When composing an SDP offer according to rules and procedures of [RFC3264] and [RFC4566] the PoC Client:

- 1. SHALL set the IP address of the PoC Client for each offered Media Stream and for each offered Media-floor Control Entity;

NOTE 3: If the PoC Client is behind NAT the IP address and port can be a different IP address and port than the one of the PoC Client depending on NAT traversal method used by SIP/IP Core.

- 2. SHALL include the media-level section for each offered Media Stream consisting of:
 - a) the port number for the Media Stream selected as specified in [OMA-PoC-UP] "*Port numbers*";
 - b) the codec(s) and Media Parameters;

NOTE 4: The Media Parameters of the Discrete Media are specified in [OMA-PoC-IM].

- c) the "a=label" attribute with a unique value as specified in [RFC4574], if the Media Stream is to be connected to a Media-floor Control Entity, except when only PoC Speech with Talk Burst Control Protocol as specified in [OMA-POC-1-UP] is offered;
- d) the "i=" field set to "speech" as specified in subclause 5.10 "*PoC Speech*" when PoC Speech with MBCP is offered.

NOTE 5: PoC Speech Media exists at most once in the SDP offer.

- e) the IP address of the PoC Client and port number to be used for RTCP at the PoC Client selected as specified in [OMA-PoC-UP] "*Port numbers*", according to rules and procedures of [RFC3605], if the Media Stream uses the RTCP protocol and other than the default IP address or port number specified by the [RFC3550] is to be used; and,
- f) under the media level definition of MSRP, add to "a=accept-types:" SDP attribute any combination of a MIME Type "application/vnd.oma.poc.final-report+xml", "application/vnd.oma.poc.detailed-progress-report+xml", and "application/vnd.oma.poc.optimized-progress-report+xml" if either Discrete Media Transfer Final Report, detailed Discrete Media Transfer Progress Report and optimized Discrete Media Transfer Progress Report respectively, is indicated to be supported.

NOTE 6: Includes an "a=sendonly" attribute for a media component if the Media Stream is placed on hold as specified in 6.1.4.2 "*PoC Client placing media on hold*".

- 3. SHALL include the media-level section of each offered Media-floor Control Entity, if any Media-floor Control Entity is offered, consisting of:
 - a) the format list field for the Media-floor Control Entity set to "TBCP";
 - b) the port number for Media-floor Control Entity selected as specified in [OMA-PoC-UP] "*Port numbers*";
 - c) the "a=floorid:0 mstrm" attribute with value(s) referencing the Media Stream as specified in [RFC4583] intended to be connected to the Media-floor Control Entity except when only PoC Speech with Talk Burst Control Protocol as specified in [OMA-POC-1-UP] is offered; and.
 - d) optionally TBCP MIME parameters as specified in E.3 "*SDP Extensions*", TBCP MIME parameter "multimedia=1" is included, unless only PoC Speech with Talk Burst Control Protocol is offered;
- 4. SHOULD include a QoE Profile attribute as specified in subclause E.3.2 "*QoE Profile*" with the following value, if QoE Profiles are provisioned to the PoC Client:
 - a) the value of the Local QoE Profile corresponding to the QoS achieved by the PoC Client for the PoC Session if the SDP offer is used in the modification of a PoC Session.

b) the QoE Profile requested by the PoC User in other case.

When composing an SDP offer, the PoC Client:

- 1. SHALL bind the media-level section that identifies PoC Speech to Media-floor Control Entity, if PoC Speech is offered;
- 2. SHALL bind the media-level section that identifies Video to Media-floor Control Entity, if Video is offered;
- 3. SHALL bind the media-level section that identifies Audio to Media-floor Control Entity, if Audio is offered; and,
- 4. SHALL bind the media-level section that identifies Discrete Media to Media-floor Control Entity, if Discrete Media is offered and bound to the Media-floor Control Entity.

When the SIP/IP Core corresponds to 3GPP/3GPP2 IMS, the PoC Client SHALL use 3GPP/3GPP2 IMS mechanisms according to rules and procedures of [3GPP TS 24.229] / [3GPP2 X.S0013.4] with the clarifications given in this subclause.

6.1.3.2 Using Pre-established Session

6.1.3.2.1 PoC Client initiates a Pre-established Session

When the PoC Client initiates a Pre-established Session the PoC Client:

- 1. SHALL generate an initial SIP INVITE request as specified in subclause 6.1.3.1 "*General*";
- 2. SHALL set the Request-URI of the SIP INVITE request to the Conference-factory-URI for the PoC service in the Home PoC Network of the PoC User;
- 3. SHALL include a MIME SDP body as an SDP offer as specified in subclause 6.1.3.1a "*SDP offer generation*";
- 4. SHALL include value 'id' in the Privacy header according to rules and procedures of [RFC3325], if privacy is requested to be used in the automatically answered terminated PoC Sessions;

NOTE 1: The included 'id' value is not valid for an outgoing SIP REFER request when initiating a PoC Session.

- 5. SHALL include the PoC Dispatcher feature tag '+g.poc.dispatcher' in the Contact header, if the PoC Dispatcher capability is supported by the PoC Client and it is enabled by the PoC User; and,
- 6. SHALL send the SIP INVITE request towards the PoC Server according to rules and procedures of the SIP/IP Core.

Upon receiving a SIP 200 "OK" response to the SIP INVITE request the PoC Client:

- 1. SHALL cache the conference URI that identifies the Pre-established Session received in the Contact header;
- 2. SHALL cache the presence of the PoC Dispatcher feature tag '+g.poc.dispatcher' in the Contact header ; and,

NOTE 2: The presence of the PoC Dispatcher feature tag '+g.poc.dispatcher' in the Contact header of the SIP 200 "OK" response acknowledges to the PoC Client that the Home PoC Server also supports Dispatch PoC Sessions. Therefore, the PoC Dispatcher bits contained in the Additional Indications field of the Connect message are valid.

- 3. SHALL interact with the User Plane as specified in [OMA-PoC-UP] "*PoC Client procedures at Pre-established Session initialization*".

When the SIP/IP Core corresponds to 3GPP/3GPP2 IMS, the PoC Client SHALL use 3GPP/3GPP2 IMS Session establishment mechanisms according to rules and procedures of [3GPP TS 24.229] / [3GPP2 X.S0013.4] with the clarifications given in this subclause.

6.1.3.2.2 PoC Client initiates an Ad-hoc PoC Group Session and 1-1 PoC Session

Upon receiving a request from a PoC User to establish an Ad-hoc PoC Group Session or a 1-1 PoC Session within a Pre-established Session the PoC Client:

- 1. SHALL generate a SIP REFER request according to rules and procedures of [RFC3515];
- 2. SHALL set the Request-URI of the SIP REFER request to the conference URI that identifies the Pre-established Session;

- 3. SHALL include the PoC feature tag '+g.poc.discretedia' in the Contact header, if Discrete Media is supported and acceptable to the PoC User during the PoC Session, and if it was included in the Pre-established Session;
- 4. SHALL in case of a 1-1 PoC Session either set the Refer-To header of the SIP REFER request to the PoC Address of the Invited PoC User according to rules and procedures of [RFC3515] and continue with the following steps; or continue in the step 5;
 - a) MAY in case of a 1-1 PoC Session and if the PoC Address is included in the Refer-To header (as specified in the step 3 above) include a URI Usage Type uri-parameter according to subclause E.5.4 "*URI Usage Type uri-parameter*"; and,
 - b) skip the step 4.
- 5. SHALL modify the SIP REFER request according to rules and procedures of [draft-multiple-refer] with the following clarifications:
 - a) include in the Refer-To header of the SIP REFER request a URL identifying the body part containing the MIME resource-lists body with the Invited PoC Users;
 - b) include a MIME resource-lists body according to rules and procedures of [draft-multiple-refer] with the list of the Invited PoC Users and invited Pre-arranged PoC Groups.
The PoC Client MAY, for each URI in the list,
 - i. set the "copyControl" attribute to 'to', and set the "anonymize" attribute to 'true' if the URI is requested to be anonymous and not to be presented to Invited PoC Users, according to rules and procedures of [draft-URI-list-capacity]; and,
 - ii. include a URI Usage Type uri-parameter according to subclause E.5.4 "*URI Usage Type uri-parameter*".
 - and,
 - c) include option tag 'multiple-refer' to the Require header.
- 6. SHALL include the following according to rules and procedures of [RFC4488], when more than one PoC User is invited:
 - a) the option tag 'norefersub' in the Require header; and,
 - b) the value 'false' in the Refer-Sub header.
- 7. MAY include the following according to rules and procedures of [RFC4488], when only one PoC User is invited:
 - a) the option tag 'norefersub' in the Require header; and,
 - b) the value 'false' in the Refer-Sub header.
- 8. SHALL include value 'id' in the Privacy header according to rules and procedures of [RFC3325], if anonymity is requested;
- 9. SHALL include in the Refer-To URI a Priv-Answer-Mode header with the value 'Auto' according to rules and procedures of [draft-answermode], in case the PoC User has requested manual answer override;
- 10. SHALL include in the Refer-To URI an Answer-Mode header with the value 'Manual;Require' according to rules and procedures of [draft-answermode], in case the PoC User has requested that Manual Answer Mode be required at the Invited PoC Client;
- 11. SHALL include in the Refer-To URI a Reject-Contact header with the feature tags 'sip.automata' and 'sip.actor' with the value of 'msg-taker' along with 'require' and 'explicit' and another Reject-Contact header the feature tags 'sip.automata' and 'sip.actor' with the value of 'principal' and 'sip.description' with the value "poc recording device" along with 'require' and 'explicit', if the PoC Client doesn't want to be routed to a PoC Box;
- 12. SHALL include in the Refer-To URI an Accept-Contact header the feature tags 'sip.automata' and 'sip.actor' with the value of 'msg-taker' along with 'require' and 'explicit' and another Accept-Contact header the feature tags 'sip.automata' and 'sip.actor' with the value of 'principal' and 'sip.description' with the value "poc recording device" along with 'require' and 'explicit', if the PoC User explicitly requests that only a PoC Box is to accept the invitation;
- 13. SHOULD include a Resource-Priority header according to rules and procedures of [RFC4412], if the QoE Profile assigned to the Pre-established Session is 'Official Government Use' QoE Profile. If included, the value of the Resource-Priority header SHALL be equal to the level of priority assigned to the PoC User, as specified in subclause 5.8 "*QoE Profiles*"; the Resource-Priority header is included as a header of the SIP REFER request as well as a Refer-to uri parameter;

NOTE 1: When using Pre-established Sessions, QoE Profile assigned to the Pre-established Session is the same than the Local QoE Profile assigned to the PoC User for any established PoC Session.

- 14. MAY include media content in one or more MIME bodies as specified in [RFC2046] with a total size equal to or less than the maximum size indicated in "INCLUDED-MEDIA-CONTENT-SIZE";

NOTE 2: If "INCLUDED-MEDIA-CONTENT-SIZE" is not provisioned or if "INCLUDED-MEDIA-CONTENT-SIZE" is provisioned and set to zero, a MIME body with a Media Type specified in [RFC2046] can not be included.

- 15. MAY include text content in Subject header in the URI of the Refer-To header according to rules and procedures of [RFC3261] with a total size equal to or less than the maximum size indicated in "INCLUDED-TEXT-CONTENT-SIZE";

NOTE 3: If "INCLUDED-TEXT-CONTENT-SIZE" is not provisioned or if "INCLUDED-TEXT-CONTENT-SIZE" is provisioned and set to zero text content as specified in [RFC3261] can not be included.

- 16. MAY include a reference to media content in the Alert-Info header or in the Call-Info header or both in the URI of the Refer-To header according to rules and procedures in [RFC3261]; and,
- 17. SHALL send the SIP REFER request towards the PoC Server within the SIP dialog of the Pre-established Session according to rules and procedures of the SIP/IP Core.

NOTE 4: If PoC User wants to cancel the PoC Session initiation, the PoC Client can send SIP BYE request and release the Pre-established Session as specified in subclause 6.1.3.2.4 "*PoC Client releases a Pre-established Session*" and re-establish the Pre-established Session as specified in 6.1.3.2.1 "*PoC Client initiates a Pre-established Session*".

Upon receiving a SIP 2xx final response to the SIP REFER request the PoC Client SHALL interact with User Plane as specified in [OMA-PoC-UP] "*PoC Client procedures at PoC Session initialization*".

Upon receiving an incoming SIP NOTIFY request that is part of the same dialog as the previously sent SIP REFER request the PoC Client:

- 1. SHALL handle the request according to rules and procedures of [RFC3515] and [RFC3265];
- 2. MAY display information to the PoC User based on the information in the SIP NOTIFY body; and,

NOTE 5: The PoC Server does not send any SIP NOTIFY request in case the value 'false' was included in the Refer-Sub header of the SIP REFER request.

- 3. SHOULD inform the PoC Server performing the Controlling PoC Function, as specified in section 6.1.4.4 "*User Plane Adaptation*" of the achieved QoE Profile if a QoE Profile was negotiated and if the PoC Client is unable to obtain that negotiated QoE Profile according to the parameters provisioned to the PoC Client, as specified in subclause 5.8 "*QoE Profiles*".

In addition to this, the PoC Client MAY subscribe to the conference state event package as specified in subclause 6.1.10 "*PoC Client subscription to the conference state event package*".

When the SIP/IP Core corresponds to 3GPP/3GPP2 IMS, the PoC Client SHALL use 3GPP/3GPP2 IMS mechanisms according to rules and procedures of [3GPP TS 24.229] / [3GPP2 X.S0013.4] with the clarifications given in this subclause.

6.1.3.2.3 PoC Client initiates a Pre-arranged PoC Group Session or joins a Chat PoC Group Session

Upon receiving a request from a PoC User to establish a Pre-arranged or Chat PoC Group Session within the Pre-established Session the PoC Client:

- 1. SHALL generate a SIP REFER request according to rules and procedures of [RFC3515];
- 2. SHALL set the Request URI of the SIP REFER request to the conference URI that identifies the Pre-established Session;

- 3. SHALL include the PoC feature tag '+g.poc.discretemedia' in the Contact header, if Discrete Media is supported and acceptable to the PoC User during the PoC Session, and if it was included in the Pre-established Session;
- 4. SHALL set the Refer-To header of the SIP REFER request to the URI of the Pre-arranged PoC Group or Chat PoC Group according to rules and procedures of [RFC3515] and include Session Type uri-parameter "session=prearranged" or "session=chat", respectively as specified in E.5.1 "*Session Type uri-parameter*";
- 5. SHALL, if the PoC Dispatcher capability is supported and if the PoC User requested to initiate a Dispatch PoC Session as PoC Dispatcher, proceed as specified in subclause 6.1.3.2.3.1 "*Dispatch PoC Session initiation as PoC Dispatcher*" before continuing with the rest of the steps;
- 6. MAY include the following according to rules and procedures of [RFC4488]:
 - a) the option tag 'norefersub' in the Require header; and,
 - b) the value 'false' in the Refer-Sub header.
- 7. SHALL include in the Refer-To URI a Priv-Answer-Mode header with the value 'Auto' according to rules and procedures of [draft-answer-mode], in case the PoC User has requested manual answer override;
- 8. SHALL include in the Refer-To URI an Answer-Mode header with the value 'Manual;Require' according to rules and procedures of [draft-answer-mode], in case the PoC User has requested that Manual Answer Mode be required at the Invited PoC Client;
- 9. SHALL include in the Refer-To URI a Reject-Contact header with the feature tags 'sip.automata' and 'sip.actor' with the value of 'msg-taker' along with 'require' and 'explicit' and in another Reject-Contact header the feature tags 'sip.automata' and 'sip.actor' with the value of 'principal' and 'sip.description' with the value "poc recording device" along with 'require' and 'explicit' if the PoC Client doesn't want to be routed to a PoC Box;
- 10. SHALL include in the Refer-To URI in an Accept-Contact header the feature tags 'sip.automata' and 'sip.actor' with the value of 'msg-taker' along with 'require' and 'explicit' and in another Accept-Contact header the feature tags 'sip.automata' and 'sip.actor' with the value of 'principal' and 'sip.description' with the value "poc recording device" along with 'require' and 'explicit' if the PoC User explicitly requests that only a PoC Box is to accept the invitation;
- 11. SHALL include value 'id' in the Privacy header according to rules and procedures of [RFC3325], if anonymity is requested;
- 12. SHOULD include a Resource-Priority header according to rules and procedures of [RFC4412], if the QoE Profile assigned to the Pre-established Session is 'Official Government Use' QoE Profile. If included, the value of the Resource-Priority header SHALL be equal to the level of priority assigned to the PoC User, as specified in subclause 5.8 "*QoE Profiles*"; the Resource-Priority header is included as a header of the SIP REFER request as well as a Refer-to URI parameter;
- 13. MAY include media content in one or more MIME bodies as specified in [RFC2046] with a total size equal to or less than the maximum size indicated in "INCLUDED-MEDIA-CONTENT-SIZE";

NOTE 1: If "INCLUDED-MEDIA-CONTENT-SIZE" is not provisioned or if "INCLUDED-MEDIA-CONTENT-SIZE" is provisioned and set to zero, a MIME body with a Media Type specified in [RFC2046] can not be included.

- 14. MAY include text content in Subject header in the URI of the Refer-To header according to rules and procedures of [RFC3261] with a total size equal to or less than the maximum size indicated in "INCLUDED-TEXT-CONTENT-SIZE";

NOTE 2: If "INCLUDED-TEXT-CONTENT-SIZE" is not provisioned or if "INCLUDED-TEXT-CONTENT-SIZE" is provisioned and set to zero text content as specified in [RFC3261] can not be included.

- 15. MAY include a reference to media content in the Alert-Info header or in the Call-Info header or both in the URI of the Refer-To header according to rules and procedures of [RFC3261]; and,

NOTE 3: Included Media Content is not applicable, when establishing a Chat PoC Group Session.

- 16. SHALL send the SIP REFER request towards the PoC Server within the SIP dialog of the Pre-established Session according to rules and procedures of the SIP/IP Core.

Upon receiving a SIP 2xx final response to the SIP REFER request the PoC Client SHALL interact with the User Plane as specified in [OMA-PoC-UP] "*PoC Client procedures at PoC Session initialization*".

NOTE 4: If PoC User wants to cancel the PoC Session initiation, the PoC Client can send SIP BYE request and release the Pre-established Session as specified in subclause 6.1.3.2.4 "*PoC Client releases a Pre-established Session*" and re-establish the Pre-established Session as specified in 6.1.3.2.1 "*PoC Client initiates a Pre-established Session*".

Upon receiving an incoming SIP NOTIFY request that is part of the same dialog as the previously sent SIP REFER request the PoC Client:

- 1. SHALL handle the request according to rules and procedures of [RFC3515] and [RFC3265];
- 2. MAY display information to the PoC User based on the information in the SIP NOTIFY body; and,
- 3. SHOULD inform the PoC Server performing the Controlling PoC Function, as specified in section 6.1.4.4 "*User Plane Adaptation*" of the achieved QoE Profile if a QoE Profile was negotiated and if the PoC Client is unable to obtain that negotiated QoE Profile according to the parameters provisioned to the PoC Client, as specified in subclause 5.8 "*QoE Profiles*".

In addition to this, the PoC Client MAY subscribe to the conference state event package as specified in subclause 6.1.10 "*PoC Client subscription to the conference state event package*".

When the SIP/IP Core corresponds to 3GPP/3GPP2 IMS, the PoC Client SHALL use 3GPP/3GPP2 IMS mechanisms according to rules and procedures of [3GPP TS 24.229] / [3GPP2 X.PS0013.4] with the clarifications given in this subclause.

6.1.3.2.3.1. Dispatch PoC Session initiation as PoC Dispatcher

If the PoC Dispatcher capability is supported and when the following procedures are required in order to establish a Dispatch PoC Session as PoC Dispatcher, as specified in subclause 6.1.3.2.3 "*PoC Client initiates a Pre-arranged PoC Group Session or joins a Chat PoC Group Session*", the PoC Client:

- 1. SHALL, in case the PoC User has requested a PoC Session with the entire Dispatch PoC Group, add the Dispatch Type uri-parameter "dispatch=entire-group" to the Refer-To URI, as specified in E.5.2 "*Dispatch Type uri-parameter*";
- 2. SHALL, in case the PoC User has requested a PoC Session with a subset of the Dispatch PoC Group:
 - a) add the Dispatch Type uri-parameter "dispatch=sub-group" to the Refer-To URI as specified in E.5.2 "*Dispatch Type uri-parameter*";
 - b) include a Content-Type header with the value "application/resource-lists+xml" or with value "multipart/mixed" as specified in [RFC2046]; and,
 - c) include a MIME resource-lists body with the list of the Invited PoC Users.

NOTE: The syntax of the Refer-To header is such that the Home PoC Server places the MIME URI-list into the body of the SIP INVITE request, targeting the Dispatch PoC Group, that results from the SIP REFER request.

- 3. SHALL include the PoC Dispatcher feature tag '+g.poc.dispatcher' in the Contact header of the SIP REFER request.

When the SIP/IP Core corresponds to 3GPP/3GPP2 IMS, the PoC Client SHALL use 3GPP/3GPP2 IMS mechanisms according to rules and procedures of [3GPP TS 24.229] / [3GPP2 X.S0013.4] with the clarifications given in this subclause.

6.1.3.2.4 PoC Client releases a Pre-established Session

When a PoC Client needs to release a Pre-established Session as created in subclause 6.1.3.2.1 "*PoC Client initiates a Pre-established Session*", the PoC Client:

- 1. SHALL generate a SIP BYE request according to rules and procedures of [RFC3261];
- 2. SHALL interact with the User Plane as specified in [OMA-PoC-UP] "*PoC Client procedures at Pre-established Session release*";
- 3. SHALL set the Request-URI of the SIP BYE request to the conference URI that identifies the Pre-established Session;
- 4. SHALL include value 'id' in the Privacy header according to rules and procedures of [RFC3325], if anonymity is requested;

- 5. SHOULD include a Resource-Priority header according to rules and procedures of [RFC4412], if the QoE Profile assigned to the Pre-established Session is 'Official Government Use 'QoE Profile. If included, the value of the Resource-Priority header SHALL be equal to the level of priority assigned to the PoC User, as specified in subclause 5.8 "QoE Profiles"; and,
- 6. SHALL send the SIP BYE request towards the PoC Server within the SIP dialog of the Pre-established Session according to rules and procedures of the SIP/IP Core.

When the SIP/IP Core corresponds to 3GPP/3GPP2 IMS, the PoC Client SHALL use 3GPP/3GPP2 IMS mechanisms according to rules and procedures of [3GPP TS 24.229] / [3GPP2 X.S0013.4] with the clarifications given in this subclause.

6.1.3.3 Establishment of an On-demand Session

6.1.3.3.1 PoC Client initiates an Ad-hoc PoC Group Session and 1-1 PoC Session

Upon receiving a request from a PoC User to establish an Ad-hoc PoC Group Session or a 1-1 PoC Session the PoC Client:

- 1. SHALL generate an initial SIP INVITE request as specified in subclause 6.1.3.1 "General";
- 2. SHALL set the Request-URI of the SIP INVITE request to the Conference-factory-URI for the PoC service in the Home PoC Network of the PoC User;
- 3. SHALL insert in the SIP INVITE request a Content-Type header with multipart/mixed as specified in [RFC2046];
- 4. SHALL include in the SIP INVITE request a MIME SDP body as an SDP offer as specified in subclause 6.1.3.1a "SDP offer generation";
- 5. SHALL insert in the SIP INVITE request a MIME resource-lists body with the PoC Address(es) of the Invited PoC User(s) and PoC Group Identities of the invited Pre-arranged PoC Group(s) according to rules and procedures of [draft-URI-list];
- 6. SHALL, for each URI in the MIME resource-lists body, set the "copyControl" attribute to 'to', and set the "anonymize" attribute to 'true' if the URI is requested to be anonymous and not to be presented to Invited PoC Users, according to rules and procedures of [draft-URI-list-capacity];
- 7. MAY, for each URI in the MIME resource-lists body, include a URI Usage Type uri-parameter according to subclause E.5.4 "URI Usage Type uri-parameter".
- 7. SHALL include a Reject-Contact header with the feature tags 'sip.automata' and 'sip.actor' with the value of 'msg-taker' along with 'require' and 'explicit' and in another Reject-Contact header the feature tags 'sip.automata' and 'sip.actor' with the value of 'principal' and 'sip.description' with the value "poc recording device" along with 'require' and 'explicit' if the PoC Client doesn't want to be routed to a PoC Box;
- 9. SHALL include in an Accept-Contact header the feature tags 'sip.automata' and 'sip.actor' with the value of 'msg-taker' along with 'require' and 'explicit' and in another Accept-Contact header the feature tags 'sip.automata' and 'sip.actor' with the value of 'principal' and 'sip.description' with the value "poc recording device" along with 'require' and 'explicit' if the PoC User explicitly requests that only a PoC Box is to accept the invitation;
- 10. SHALL include in the SIP INVITE request a Priv-Answer-Mode header with the value 'Auto' according to rules and procedures of [draft-answer-mode], in case the PoC User has requested manual answer override;
- 11. SHALL include in the SIP INVITE request an Answer-Mode header with the value 'Manual;Require' according to rules and procedures of [draft-answer-mode], in case the PoC User has requested that Manual Answer Mode be required at the Invited PoC Client;
- 12. SHALL include value 'id' in the Privacy header according to rules and procedures of [RFC3325], if anonymity is requested; and,
- 13. SHALL send the SIP INVITE request towards the PoC Server according to rules and procedures of the SIP/IP Core.

On receiving a SIP 180 "Ringing" response to the SIP INVITE request the PoC Client:

- 1. SHALL cache the list of supported SIP methods if received in the Allow header;
- 2. SHALL cache the PoC Session Identity if received in the Contact header; and,
- 3. MAY indicate the progress of the PoC Session establishment to the Inviting PoC User.

On receiving a SIP 200 "OK" response to the SIP INVITE request the PoC Client:

- 1. SHALL cache the list of supported SIP methods if received in the Allow header;
- 2. SHALL cache the PoC Session Identity if received in the Contact header;
- 3. MAY notify the Media Burst Control Scheme to the PoC User if received the indication of Media Burst Control Scheme;
- 4. SHALL notify the PoC User that the PoC Session has been established with a PoC Box if the Contact header contains the feature tags 'sip.automata'; and either
 - a) the feature tag 'sip.actor' with the value 'msg-taker'; or,
 - b) the feature tag 'sip.actor' with the value 'principal' and the feature tag 'sip.description' with the value "poc recording device";
- 5. MAY notify the PoC User that the PoC Session has been established with a UE PoC Box if the Contact header contains the feature tags 'sip.actor' with the value 'principal' and 'sip.description' with the value "poc recording device" along with the feature tag 'sip.automata';
- 6. SHALL interact with the User Plane as specified in [OMA-PoC-UP] *"PoC Client procedures at PoC Session initialization"*; and,
- 7. MAY notify the answer state to the PoC User (i.e. "Unconfirmed" or "Confirmed") if received in the P-Answer-State header in the response.

NOTE: According to [draft-URI-list] the received 200 "OK" means that the conference was created successfully, that the client that generated the SIP INVITE request is in the conference, and that the server understood the URI-list. If the client wishes to obtain information about the status of other users in the conference it uses general conference mechanisms, such as the conference state event package.

In addition to this, the PoC Client MAY subscribe to the conference state event package as specified in subclause 6.1.10 *"PoC Client subscription to the conference state event package"*.

When the SIP/IP Core corresponds to 3GPP/3GPP2 IMS, the PoC Client SHALL use 3GPP/3GPP2 IMS Session establishment mechanisms according to rules and procedures of [3GPP TS 24.229] / [3GPP2 X.S0013.4] with the clarifications given in this subclause.

6.1.3.3.2 PoC Client initiates a Pre-arranged PoC Group Session or joins a Chat PoC Group Session

Upon receiving a request from a PoC User to establish a PoC Group Session using a PoC Group Identity, identifying a Pre-arranged PoC Group or a Chat PoC Group the PoC Client:

- 1. SHALL generate an initial SIP INVITE request as specified in subclause 6.1.3.1 *"General"*;
- 2. SHALL set the Request-URI of the SIP INVITE request to the PoC Group Identity identifying the PoC Group;
- 3. SHALL include a Reject-Contact header with the feature tags 'sip.automata' and 'sip.actor' with the value of 'msg-taker' along with 'require' and 'explicit' and in another Reject-Contact header the feature tags 'sip.automata' and 'sip.actor' with the value of 'principal' and 'sip.description' with the value "poc recording device" along with 'require' and 'explicit' if the PoC Client doesn't want to be routed to a PoC Box;
- 4. SHALL include in an Accept-Contact header the feature tags 'sip.automata' and 'sip.actor' with the value of 'msg-taker' along with 'require' and 'explicit' and in another Accept-Contact header the feature tags 'sip.automata' and 'sip.actor' with the value of 'principal' and 'sip.description' with the value "poc recording device" along with 'require' and 'explicit' if the PoC User explicitly requests that only a PoC Box is to accept the invitation;
- 5. MAY include in the Request-URI Session Type uri-parameter "session=prearranged" or "session=chat" respectively as specified in E.5.1 *"Session Type uri-parameter"*;

NOTE 1: The inclusion of the Session Type uri-parameter in the Request-URI in case of the On-demand Sessions is not mandatory, as it is not needed by the PoC Server for further processing by the Controlling PoC Function. In case the Session Type uri-parameter is included, the Controlling PoC Function checks whether it is set correctly.

- 6. SHALL include in the SIP INVITE request a MIME SDP body as an SDP offer as specified in subclause 6.1.3.1a *"SDP offer generation"*;

- 7. SHALL include in the SIP INVITE request a Priv-Answer-Mode header with the value 'Auto' according to rules and procedures of [draft-answer-mode], in case the PoC User has requested manual answer override;

NOTE 2: The PoC Server performing the Controlling PoC Function will ignore the manual answer override indication in case the PoC Group Identity identifies a Chat PoC Group.

- 8. SHALL include in the SIP INVITE request an Answer-Mode header with the value 'Manual;Require' according to rules and procedures of [draft-answer-mode], in case the PoC User has requested that Manual Answer Mode be required at the Invited PoC Client;
- 9. SHALL include value 'id' in the Privacy header according to rules and procedures of [RFC3325], if anonymity is requested;

NOTE 3: If anonymity is not allowed for the PoC Group indicated with the Request-URI of the SIP INVITE request based on rules specified in the [OMA-PoC-Document-Mgmt] the PoC Session will not be allowed by the PoC Server hosting the PoC Group.

- 10. SHALL, if PoC Dispatcher capability is supported and if the PoC User requested to initiate a Dispatch PoC Session as PoC Dispatcher, proceed as specified in subclause 6.1.3.3.2.1 "*Dispatch PoC Session initiation as PoC Dispatcher*" before continuing with the rest of the steps; and,
- 11. SHALL send the SIP INVITE request towards the PoC Server according to rules and procedures of the SIP/IP Core.

On receiving a SIP 180 "Ringing" response to the SIP INVITE request the PoC Client:

- 1. SHALL cache the list of supported SIP methods if received in the Allow header;
- 2. SHALL cache the PoC Session Identity if received in the Contact header;
- 3. MAY indicate the progress of the PoC Session establishment to the Inviting PoC User; and,
- 4. SHALL, if the PoC Dispatcher or PoC Fleet Member capability is supported, notify the presence and value of the Dispatch Type uri-parameter in the Contact header or in the Authenticated Originator's PoC Address to the Inviting PoC User.

On receiving a SIP 200 "OK" response to the SIP INVITE request, the PoC Client:

- 1. SHALL cache the list of supported SIP methods if received in the Allow header;
- 2. SHALL cache the PoC Session Identity received in the Contact header;
- 3. MAY notify the Media Burst Control Scheme to the PoC User if received the indication of Media Burst Control Scheme;
- 4. SHALL notify the PoC User that the PoC Session has been established with a PoC Box if the Contact header contains the feature tag 'sip.automata'; and either:
 - a) the feature tag 'sip.actor' with the value 'msg-taker'; or,
 - b) the feature tag 'sip.actor' with the value 'principal' and the feature tag 'sip.description' with the value "poc recording device"
- 5. MAY notify the PoC User that the PoC Session has been established with a UE PoC Box if the Contact header contains the feature tag 'sip.actor' with the value 'principal' and 'sip.description' with the value "poc recording device" along with the feature tag 'sip.automata';
- 6. SHALL interact with the User Plane as specified in [OMA-PoC-UP] "*PoC Client procedures at PoC Session initialization*";
- 7. MAY notify the answer state to the PoC User (i.e. "Unconfirmed" or "Confirmed") if received in the P-Answer-State header in the response, and,
- 8. SHALL, if the PoC Dispatcher or PoC Fleet Member capability is supported, notify the presence and value of the Dispatch Type uri-parameter in the Contact header or in the Authenticated Originator's PoC Address to the Inviting PoC User.

In addition to this, the PoC Client MAY subscribe to the conference state event package as specified in subclause 6.1.10 "*PoC Client Subscription to the conference state event package*".

When the SIP/IP Core corresponds to 3GPP/3GPP2 IMS, the PoC Client SHALL use 3GPP/3GPP2 IMS Session establishment mechanisms according to rules and procedures of [3GPP TS 24.229] / [3GPP2 X.S0013.4] with the clarifications given in this subclause.

6.1.3.3.2.1. Dispatch PoC Session initiation as PoC Dispatcher

If the PoC Dispatcher capability is supported and when the following procedures are required in order to establish a Dispatch PoC Session as PoC Dispatcher, as specified in subclause 6.1.3.3.2 "*PoC Client initiates a Pre-arranged PoC Group Session or joins a Chat PoC Group Session*", the PoC Client:

- 1. SHALL include in the SIP INVITE request the PoC Dispatcher feature tag '+g.poc.dispatcher' in the Contact header according to rules and procedures of [RFC3840];
- 2. SHALL, in case the PoC User has requested a PoC Session with the entire Dispatch PoC Group, include in the Request-URI Dispatch Type uri-parameter "dispatch=entire-group"; and,
- 3. SHALL, in case the PoC User has requested a PoC Session with a sub-set of the Dispatch PoC Group:
 - a) include in the Request-URI Dispatch Type uri-parameter "dispatch=sub-group";
 - b) insert in the SIP INVITE request a Content-Type header with the value "multipart/mixed" as specified in [RFC2046]; and,
 - c) insert in the SIP INVITE request a MIME resource-lists body with the PoC Address(es) of the Invited PoC User(s) according to rules and procedures of [draft-URI-list].

When the SIP/IP Core corresponds to 3GPP/3GPP2 IMS, the PoC Client SHALL use 3GPP/3GPP2 IMS mechanisms according to rules and procedures of [3GPP TS 24.229] / [3GPP2 X.S0013.4] with the clarifications given in this subclause.

6.1.4 PoC Client PoC Session modification

6.1.4.1 General

NOTE 1: This subclause provides common procedures for other subclauses and is not meant to be applied unless referenced.

The PoC Client SHALL generate either a SIP UPDATE request according to rules and procedures of [RFC3311] or a SIP re-INVITE request according to rules and procedures of [RFC3261]. A SIP UPDATE request MAY be used only if the PoC Server has indicated support for the SIP UPDATE method.

NOTE 2: The use of the option tag 'precondition', as specified in [RFC3312], and the option tag '100rel', as specified in [RFC3262], is not defined for the POC-1 reference point.

When NAT traversal is supported by the PoC Client and when the PoC Client is behind NAT generation of SIP requests is done as specified in this subclause and as specified in [sip-outbound].

When the SIP/IP Core corresponds to 3GPP/3GPP2 IMS, the PoC Client SHALL use 3GPP/3GPP2 IMS Session mechanisms according to rules and procedures of [3GPP TS 24.229] / [3GPP2 X.S0013.4] with the clarifications given in this subclause.

6.1.4.2 PoC Client placing media on hold

This subclause describes the optional procedures that the PoC Client SHALL use when placing a media component on hold.

When the PoC Client sets a media component on hold the PoC Client:

- 1. SHALL generate SIP UPDATE request or a SIP re-INVITE request as specified in subclause 6.1.4.1 "*General*";
- 2. SHALL include in the SIP request a MIME SDP body as an SDP offer as specified in subclause 6.1.3.1a "*SDP offer generation*" with the modified capabilities;
- 3. SHALL include an "a=sendonly" attribute in the SDP offer for a media component which is placed on hold;
- 4. SHOULD include a Resource-Priority header according to rules and procedures of [RFC4412], if the Local QoE Profile assigned to the PoC User for the on-going PoC Session is 'Official Government Use'. If included, the value

of the Resource-Priority header SHALL be equal to the level of priority assigned to the PoC User, as specified in subclause 5.8 "*QoE Profiles*"; and,

- 5. SHALL send the SIP request towards the PoC Server according to rules and procedures of the SIP/IP Core.

On receipt of the SIP 200 "OK" response the PoC Client:

- 1. SHALL interact with the User Plane as specified in [OMA-PoC-UP] "*Media on and off hold*"; and,
- 2. SHALL start to use the Media Parameters received in the MIME SDP body.

NOTE: If a SIP 200 "OK" response is not received the PoC Client continues to use the previously agreed Media Parameters.

When the SIP/IP Core corresponds to 3GPP/3GPP2 IMS, the PoC Client SHALL use 3GPP/3GPP2 IMS session mechanisms according to rules and procedures of [3GPP TS 24.229] / [3GPP2 X.S0013.4] with the clarifications given in this subclause.

6.1.4.3 PoC Client placing media off hold

This subclause describes the procedures that the PoC Client SHALL use when re-activating a media component that had been on hold.

When the PoC Client activates a media component, the PoC Client:

- 1. SHALL generate a SIP UPDATE request or a SIP re-INVITE request as specified in subclause 6.1.4.1 "*General*";
- 2. SHALL include in the SIP request a MIME SDP body as an SDP offer as specified in subclause 6.1.3.1a "*SDP offer generation*" with the modified capabilities;
- 3. SHALL include an "a=sendrecv" attribute in the SDP offer for a media component which is activated again;
- 4. SHOULD include a Resource-Priority header according to rules and procedures of [RFC4412], if the Local QoE Profile assigned to the PoC User for the on-going PoC Session is 'Official Government Use'. If included, the value of the Resource-Priority header SHALL be equal to the level of priority assigned to the PoC User, as specified in subclause 5.8 "*QoE Profiles*"; and,
- 5. SHALL send the SIP request towards the PoC Server according to rules and procedures of the SIP/IP Core.

On receipt of the SIP 200 "OK" response the PoC Client:

- 1. SHALL interact with the User Plane as specified in [OMA-PoC-UP] "*Media on and off hold*"; and,
- 2. SHALL start to use the Media Parameters received in the MIME SDP body.

NOTE: If a SIP 200 "OK" response is not received the PoC Client continues to use the previously agreed Media Parameters.

When the SIP/IP Core corresponds to 3GPP/3GPP2 IMS, the PoC Client SHALL use 3GPP/3GPP2 IMS session mechanisms according to rules and procedures of [3GPP TS 24.229] / [3GPP2 X.S0013.4] with the clarifications given in this subclause.

6.1.4.4 User Plane adaptation

This subclause describes the optional procedures that the PoC Client SHALL use when initiating User Plane adaptation during an ongoing PoC Session.

When initiating User Plane adaptation the PoC Client:

- 1. SHALL generate a SIP UPDATE request or a SIP re-INVITE request as specified in subclause 6.1.4.1 "*General*";
- 2. SHALL include in the SIP request a MIME SDP body as an SDP offer as specified in subclause 6.1.3.1a "*SDP offer generation*" with the modified Media Parameters;
- 3. SHOULD include a Resource-Priority header according to rules and procedures of [RFC4412], if the Local QoE Profile assigned to the PoC User for the on-going PoC Session is 'Official Government Use'. If included, the value of the Resource-Priority header SHALL be equal to the level of priority assigned to the PoC User, as specified in subclause 5.8 "*QoE Profiles*"; and,
- 4. SHALL send the SIP request towards the PoC Server according to rules and procedures of the SIP/IP Core.

On receipt of the SIP 200 "OK" response the PoC Client:

- 1. SHALL interact with the User Plane as specified in [OMA-PoC-UP] "*User Plane adaptation*"; and,
- 2. SHALL start to use the Media Parameters received in the MIME SDP body.

NOTE: If a SIP 200 "OK" response is not received the PoC Client continues to use the previously agreed Media Parameters.

When the SIP/IP Core corresponds to 3GPP/3GPP2 IMS, the PoC Client SHALL use 3GPP/3GPP2 IMS Session mechanisms according to rules and procedures of [3GPP TS 24.229] / [3GPP2 X.S0013.4] with the clarifications given in this subclause.

6.1.4.5 SIP Session refresh

Prior to the expiry of the SIP Session timer the PoC Client:

- 1. SHALL generate either a SIP UPDATE request or a SIP re-INVITE request as specified in subclause 6.1.4.1 "*General*". It is RECOMMENDED that SIP UPDATE request be used instead of a SIP re-INVITE request if supported by PoC Client and PoC Server;
- 2. SHOULD include the Session-Expires header according to rules and procedures of [RFC4028], "*Generating Subsequent Session Refresh Requests*". It is RECOMMENDED that the refresher parameter is set to 'uac'.
- 3. SHALL include option tag 'timer' in the Supported header;
- 4. SHALL include in the SIP re-INVITE request a MIME SDP body as an SDP offer as specified in subclause 6.1.3.1a "*SDP offer generation*", if SIP re-INVITE request is used;
- 5. SHOULD include a Resource-Priority header according to rules and procedures of [RFC4412], if the Local QoE Profile assigned to the PoC User for the on-going PoC Session is 'Official Government Use'. If included, the value of the Resource-Priority header SHALL be equal to the level of priority assigned to the PoC User, as specified in subclause 5.8 "*QoE Profiles*"; and,
- 6. SHALL send the SIP request towards the PoC Server according to rules and procedures of the SIP/IP Core.

On receipt of the SIP 200 "OK" response the PoC Client:

- 1. SHALL interact with the User Plane as specified in [OMA-PoC-UP] "*User Plane adaptation*", if SIP re-INVITE was used and there are changes in the SDP answer in comparison to the previously received SDP body.

When the SIP/IP Core corresponds to 3GPP/3GPP2 IMS, the PoC Client SHALL use 3GPP/3GPP2 IMS Session refresh mechanisms according to rules and procedures of [3GPP TS 24.229] / [3GPP2 X.S0013.4] with the clarifications given in this subclause.

6.1.4.6 Adding and disconnecting from Media Stream

This subclause describes the procedures that the PoC Client uses when the PoC Client attempts to add a new Media Stream to an existing PoC Session, to connect to a Media Stream that is used in the PoC Session to disconnect from a Media Stream that is currently used by the PoC Client in the PoC Session, to change the Media-floor Control Entity binding of an used Media or combination of these.

NOTE 1: To avoid removing the Media Type from all the Participants the PoC Client authorized to remove the Media Type can put the Media Stream on hold instead of disconnecting from the Media Stream.

When the PoC User requests to add a Media Stream, to connect to a Media Stream or to disconnect from a Media Stream, the PoC Client:

- 1. MAY generate a SIP UPDATE request according to rules and procedures of [RFC3311], if the PoC Client supports the SIP UPDATE request and if
 - a) the PoC Server performing the Participating PoC Function has indicated support for the SIP UPDATE method;
 - b) the offered Media Streams and the offered Media-floor Control Entities are used in the PoC Session by the PoC Client; and,

- c) the offered Media-floor Control Entity binding of each Media Stream used and offered is the same as used; and SHALL generate a SIP re-INVITE request according to rules and procedures of [RFC3261], if the SIP UPDATE request is not generated;
- 2. SHALL include in the SIP request a MIME SDP body as an SDP offer as specified in subclause 6.1.3.1a "*SDP offer generation*";
 - 3. SHOULD include a Resource-Priority header according to rules and procedures of [RFC4412], if the Local QoE Profile assigned to the PoC User for the on-going PoC Session is 'Official Government Use'. If included, the value of the Resource-Priority header SHALL be equal to the level of priority assigned to the PoC User, as specified in subclause 5.8 "*QoE Profiles*";
 - 4. SHALL interact with the User Plane as specified [OMA-PoC-UP] "*PoC Client procedures when disconnecting from a Media Type*" if removing a Media-floor Control Entity or if changing the Media-floor Control Entity bindings or if disconnecting from an existing Media Type; and,
 - 5. SHALL send the SIP request towards the PoC Server according to rules and procedures of the SIP/IP Core.

On receipt of the SIP 200 "OK" response the PoC Client:

- 1. SHALL interact with User Plane as specified in [OMA-PoC-UP] "*User Plane adaptation*", if there is change in Media Parameters, Media formats or codecs in the received SDP answer, compared to those previously agreed SDP;
- 2. SHALL interact with User Plane as specified in [OMA-PoC-UP] "*PoC Client procedures when disconnecting from a Media Type*", if there is a Media Stream, that is currently used in the PoC Session, marked as rejected in the received SDP answer or if the current Media-floor Control Entity binding of a Media used by the PoC Client and accepted in the received SDP answer is not the same as in the received SDP answer; and,
- 3. SHALL interact with User Plane as specified in [OMA-PoC-UP] "*PoC Client procedures when connecting to a Media Type*", if there is a Media Stream accepted in the received SDP answer, that is not currently used by the Participant in the PoC Session or if the current Media-floor Control Entity binding of a Media used by the PoC Client and accepted in the received SDP answer is not the same as in the received SDP answer.

NOTE 2: The PoC Client keeps resources for previously agreed Media Stream, Media-floor Control Entities, Media Parameters and codecs until it receives a SIP 200 "OK" response.

When the SIP/IP Core corresponds to 3GPP/3GPP2 IMS, the PoC Client SHALL use 3GPP/3GPP2 IMS session mechanisms according to rules and procedures of [3GPP TS 24.229] / [3GPP2 X.S0013.4] with the clarifications given in this subclause.

6.1.4.7 Enabling and disabling the Discrete Media Transfer Progress Report and the Final Report

This subclause describes the procedures that the PoC Client SHALL use when the PoC Client wishes to enable or disable the Discrete Media Transfer Final Report, detailed Discrete Media Transfer Progress Report, optimized Discrete Media Transfer Progress Report in the ongoing PoC Session, if the PoC Client supports these features.

When enabling or disabling the Discrete Media Transfer Final Report, detailed Discrete Media Transfer Progress Report or optimized Discrete Media Transfer Progress Report, if the PoC Client supports these features, the PoC Client:

- 1. SHALL generate a SIP UPDATE request or a SIP re-INVITE request as specified in subclause 6.1.4.1 "*General*";
- 2. SHALL include in the SIP request a MIME SDP body as an SDP offer as specified in subclause 6.1.3.1a "*SDP offer generation*" with the modified Media Parameters;

NOTE: The enabling of Discrete Media Transfer Final Report, detailed Discrete Media Transfer Progress Report or optimized Discrete Media Transfer Progress Report for a Discrete Media is indicated by including MIME types "application/vnd.oma.poc.final-report+xml", "application/vnd.oma.poc.detailed-progress-report+xml" or "application/vnd.oma.poc.optimized-progress-report+xml" into the "a=accept-types:" SDP attribute of the Discrete Media.

- 3. SHOULD include a Resource-Priority header according to rules and procedures of [RFC4412], if the Local QoE Profile assigned to the PoC User within the on-going PoC Session is 'Official Government Use'. If included, the value of the Resource-Priority header SHALL be equal to the level assigned to the PoC User, as specified in subclause 5.8 "*QoE Profiles*"; and,

- 4. SHALL send the SIP request towards the PoC Server according to rules and procedures of the SIP/IP Core.

On receipt of the SIP 200 "OK" response the PoC Client:

- 1. SHALL interact with the User Plane as specified in [OMA-PoC-UP] "*User Plane adaptation*"; and,
- 2. SHALL start to use the Media Parameters received in the MIME SDP body.

If a SIP 200 "OK" response is not received the PoC Client SHALL continue to use the previously agreed Media Parameters.

When the SIP/IP Core corresponds to 3GPP/3GPP2 IMS, the PoC Client SHALL use 3GPP/3GPP2 IMS Session mechanisms according to rules and procedures of [3GPP TS 24.229] / [3GPP2 X.S0013.4] with the clarifications given in this subclause.

6.1.4.8 PoC Client modifies the Pre-established Session

This subclause describes the procedures that the PoC Client uses when the PoC Client attempts to modify the negotiated Media Streams, codecs, Media formats or Media Parameters of the Pre-established Session without associated PoC Session.

When the PoC User requests to modify the Pre-established Session without associated PoC Session, the PoC Client:

- 1. SHALL generate a SIP UPDATE request or a SIP re-INVITE request as specified in subclause 6.1.4.1 "*General*";
- 2. SHALL include in the SIP request a MIME SDP body as an SDP offer as specified in subclause 6.1.3.1a "*SDP offer generation*";
- 3. SHALL include the PoC feature tag '+g.poc.discretedia' in the Contact header, if Discrete Media is supported and acceptable to the PoC User in the PoC Sessions established using the Pre-established Session;

NOTE 1: If PoC feature tag '+g.poc.discretedia' was already included in the Contact header in the Pre-established Session and is no longer acceptable to the PoC User, the PoC Client generates a SIP re-INVITE request without the PoC feature tag '+g.poc.discretedia' in the Contact header.

- 4. SHOULD include a Resource-Priority header according to rules and procedures of [RFC4412], if the PoC Client supports 'Official Government Use' QoE Profile and the PoC User requests that QoE Profile. If included, the value of the Resource-Priority header SHALL be equal to the level of priority assigned to the PoC User, as specified in subclause 5.8 "*QoE Profiles*";
- 5. SHALL interact with the User Plane as specified [OMA-PoC-UP] "*PoC Client procedures when disconnecting from a Media Type*" if removing a Media-floor Control Entity or if changing the Media-floor Control Entity bindings or if disconnecting from an existing Media Type; and,
- 6. SHALL send the SIP request towards the PoC Server according to rules and procedures of the SIP/IP Core.

On receipt of the SIP 200 "OK" response the PoC Client:

- 1. SHALL interact with User Plane as specified in [OMA-PoC-UP] "*User Plane adaptation*", if there is change in Media Parameters, Media formats or codecs in the received SDP answer, compared to those previously agreed SDP;
- 2. SHALL interact with User Plane as specified in [OMA-PoC-UP] "*PoC Client procedures when disconnecting from a Media Type*", if there is a Media Stream, that is currently used in the Pre-established Session, marked as rejected in the received SDP answer or if the current Media-floor Control Entity binding of a Media Stream used by the PoC Client and accepted in the received SDP answer is not the same as in the received SDP answer; and,
- 3. SHALL interact with User Plane as specified in [OMA-PoC-UP] "*PoC Client procedures when connecting to a Media Type*", if there is a Media Stream accepted in the received SDP answer, that is not currently used by the Participant in the Pre-established Session or if the current Media-floor Control Entity binding of a Media Stream used by the PoC Client and accepted in the received SDP answer is not the same as in the received SDP answer.

NOTE 2: The PoC Client keeps resources for previously agreed Media Stream, Media-floor Control Entities, Media Parameters and codecs until it receives a SIP 200 "OK" response.

When the SIP/IP Core corresponds to 3GPP/3GPP2 IMS, the PoC Client SHALL use 3GPP/3GPP2 IMS session mechanisms according to rules and procedures of [3GPP TS 24.229] / [3GPP2 X.S0013.4] with the clarifications given in this subclause.

6.1.5 PoC Client rejoining a PoC Session

6.1.5.1 On-demand Session establishment

Upon receiving a request from a PoC User to re-join a PoC Session the PoC Client:

- 1. SHALL generate an initial SIP INVITE request as specified in subclause 6.1.3.1 "*General*";
- 2. SHALL set the Request-URI to the PoC Session Identity;

NOTE 1: The PoC Session Identity includes the Session Type uri-parameter indicating the PoC Session type e.g. "session=prearranged", "session=chat" or "session=adhoc" as defined in E.5.1 "*Session Type uri-parameter*".

- 3. SHALL include a MIME SDP body as an SDP offer as specified in subclause 6.1.3.1a "*SDP offer generation*";
- 4. SHALL include value 'id' in the Privacy header according to rules and procedures of [RFC3325], if anonymity is requested; and,

NOTE 2: If anonymity is not allowed for the PoC Group indicated with the Request-URI of the SIP INVITE based on rules specified in the [OMA-PoC-Documents-Mgmt] the PoC Session will not be allowed by the PoC Server hosting the PoC Group.

- 5. SHALL send the SIP INVITE request towards the PoC Server according to rules and procedures of the SIP/IP Core.

On receiving a SIP 200 "OK" response to the SIP INVITE request the PoC Client:

- 1. SHALL cache the list of supported SIP methods if received in the Allow header;
- 2. SHALL cache the PoC Session Identity received in the Contact header;
- 3. MAY notify the Media Burst Control Scheme to the PoC User if an indication of a Media Burst Control Scheme is received; and,
- 4. SHALL interact with the User Plane as specified in [OMA-PoC-UP] "*PoC Client procedures at PoC Session initialization*".

In addition to this, the PoC Client MAY subscribe to the conference state event package as specified in subclause 6.1.10 "*PoC Client subscription to the conference state event package*".

When the SIP/IP Core corresponds to 3GPP/3GPP2 IMS, the PoC Client SHALL use 3GPP/3GPP2 IMS Session establishment mechanisms according to rules and procedures of [3GPP TS 24.229] / [3GPP2 X.S0013.4] with the clarifications given in this subclause.

6.1.5.2 Pre-established Session

Upon receiving a request from a PoC User to re-join a PoC Session within a Pre-established Session that has been established as specified in subclause 6.1.3.2.1 "*PoC Client initiates a Pre-established Session*", the PoC Client:

- 1. SHALL generate a SIP REFER request according to rules and procedures of [RFC3515];
- 2. SHALL set the Request-URI of the SIP REFER request to the conference URI that identifies the Pre-established Session;
- 3. SHALL include the PoC feature tag '+g.poc.discretemedia' in the Contact header, if Discrete Media is supported and acceptable to the PoC User during the PoC Session, and if it was included in the Pre-established Session;
- 4. SHALL set the Refer-To header of the SIP REFER request to the PoC Session Identity of the PoC Session to be re-joined with the Session Type uri-parameter indicating the PoC Session type, e.g. "session=prearranged", "session=chat" or "session=adhoc" as defined in E.5.1 "*Session Type uri-parameter*";

NOTE: The PoC Session Identity of the PoC Session to be re-joined may have been received in the TBCP Connect message.

- 5. MAY include the following according to rules and procedures of [RFC4488]:
 - a) the option tag 'norefersub' in the Require header; and,

- b) the value 'false' in the Refer-Sub header.
- 6. SHALL include value 'id' in the Privacy header according to rules and procedures of [RFC3325] , if anonymity is requested;
- 7. SHOULD include a Resource-Priority header according to rules and procedures of [RFC4412], if the QoE Profile assigned to the Pre-established Session is 'Official Government Use' QoE Profile. If included, the value of the Resource-Priority header SHALL be equal to the level of priority assigned to the PoC User, as specified in subclause 5.8 "*QoE Profiles*"; the Resource-Priority header is included as a header of the SIP REFER request as well as a Refer-to URI parameter; and,
- 8. SHALL send the SIP REFER request towards the PoC Server via SIP/IP Core within the SIP dialog of the Pre-established Session according to rules and procedures of the SIP/IP Core.

Upon receiving a SIP 2xx response to the SIP REFER request the PoC Client SHALL interact with the User Plane as specified in the [OMA-PoC-UP] "*PoC Client procedures at PoC Session initialization*".

Upon receiving a SIP NOTIFY request that is part of the same dialog as the previously sent SIP REFER request the PoC Client:

- 1. SHALL handle the request according to rules and procedures of [RFC3515] and [RFC3265]; and,
- 2. MAY display information to the PoC User based on the information in the SIP NOTIFY body.

In addition to this, the PoC Client MAY subscribe to the conference state event package as specified in subclause 6.1.10 "*PoC Client subscription to the conference state event package*".

When the SIP/IP Core corresponds to 3GPP/3GPP2 IMS, the PoC Client SHALL use 3GPP/3GPP2 IMS mechanisms according to rules and procedures of [3GPP TS 24.229] / [3GPP2 X.S0013.4] with the clarifications given in this subclause.

6.1.6 PoC Client leaving a PoC Session

6.1.6.1 Leaving a PoC Session - On-demand Session case

When a Participant wants to leave the PoC Session that has been established using On-demand Session signaling as specified in subclause 6.1.3.3 "*Establishment of an On-demand Session*" or as specified in subclause 6.1.5.1 "*On-demand Session establishment*", the PoC Client:

- 1. SHALL interact with the User Plane as specified in [OMA-PoC-UP] "*PoC Client procedures at PoC Session release*";
- 2. SHALL generate a SIP BYE request according to rules and procedures of [RFC3261];
- 3. SHALL set the Request-URI to the PoC Session Identity of the PoC Session to leave;
- 4. SHALL include value 'id' in the Privacy header according to rules and procedures of [RFC3325], if anonymity is requested;
- 5. SHOULD include a Resource-Priority header according to rules and procedures of [RFC4412], if the PoC Client is allowed to use the 'Official Government Use' QoE Profile and the PoC User requests that QoE Profile. If included, the value of the Resource-Priority header SHALL be equal to the level of priority assigned to the PoC User, as specified in subclause 5.8 "*QoE Profiles*"; and,
- 6. SHALL send a SIP BYE request towards PoC Server according to rules and procedures of SIP/IP Core.

Upon receiving a SIP 200 "OK" response to the SIP BYE request, the PoC Client SHALL interact with the User Plane as specified in [OMA-PoC-UP] "*PoC Client procedures at PoC Session release*".

NOTE: Depending on the release policy described in subclause 7.2.1.16 "*PoC Session release policy*" this procedure either removes the release initiator from the PoC Session or releases the whole PoC Session.

When the SIP/IP Core corresponds to 3GPP/3GPP2 IMS, the PoC Client SHALL use 3GPP/3GPP2 IMS mechanisms according to rules and procedures of [3GPP TS 24.229] / [3GPP2 X.S0013.4] with the clarifications given in this subclause.

6.1.6.2 Leaving a PoC Session – Pre-established Session case

Upon receiving a request from a PoC User to leave a PoC Session, the PoC Client:

- 1. SHALL interact with the User Plane as specified in [OMA-PoC-UP] "*PoC Client procedures at PoC Session release*";
- 2. SHALL generate a SIP REFER request according to rules and procedures of [RFC3515];
- 3. SHALL set the Request-URI of the SIP REFER request to the conference URI that identifies the Pre-established Session;
- 4. SHALL set the Refer-To header of the SIP REFER request to the PoC Session Identity to leave;

NOTE 1: The PoC Session Identity of the PoC Session to leave may have been received in the TBCP Connect message or in the SIP NOTIFY request associated with the SIP REFER request.

- 5. MAY include the following according to rules and procedures of [RFC4488]:
 - a) the option tag 'norefersub' in the Require header; and,
 - b) the value 'false' in the Refer-Sub header.
- 6. SHALL include the "method" parameter with the value "BYE" in the Refer-To header;
- 7. SHALL include value 'id' in the Privacy header according to rules and procedures of [RFC3325], if anonymity is requested;
- 8. SHOULD include a Resource-Priority header according to rules and procedures of [RFC4412], if the PoC Client is allowed to use the 'Official Government Use' QoE Profile and the PoC User requests that QoE Profile. If included, the value of the Resource-Priority header SHALL be equal to the level of priority assigned to the PoC User, as specified in subclause 5.8 "*QoE Profiles*"; the Resource-Priority header is included as a header of the REFER request as well as a Refer-to URI parameter; and,
- 9. SHALL send the SIP REFER request towards the PoC Server via SIP/IP Core within the SIP dialog of the Pre-established Session according to rules and procedures of the SIP/IP Core.

Upon receiving a SIP 2xx response to the SIP REFER request, the PoC Client:

- 1. SHALL handle it according to rules and procedures of [RFC3515] and [RFC3265]; and,
- 2. SHALL interact with the User Plane as specified in [OMA-PoC-UP] "*PoC Client procedures at PoC Session release*".

NOTE 2: If the Media Streams of the Pre-established Session were modified by the PoC Session initiation or a PoC Session modification, the PoC Client can initiate the Pre-established Session modification in 6.1.4.8 "*Pre-established Session modification*" to restore the Media Streams used before the association of the PoC Session with the Pre-established Session.

Upon receiving an incoming SIP NOTIFY request that is part of the same dialog as the previously sent SIP REFER request the PoC Client:

- 1. SHALL handle the request according to rules and procedures of [RFC3515] and [RFC3265]; and,
- 2. MAY display information to the PoC User based on the information in the SIP NOTIFY body.

NOTE 3: Depending on the release policy described in subclause 7.2.1.16 "*PoC Session release policy*" this procedure either removes the release initiator from the PoC Session or releases the whole PoC Session.

When the SIP/IP Core corresponds to 3GPP/3GPP2 IMS, the PoC Client SHALL use 3GPP/3GPP2 IMS mechanisms according to rules and procedures of [3GPP TS 24.229] / [3GPP2 X.S0013.4] with the clarifications given in this subclause.

6.1.7 PoC Client adding PoC User(s) to a PoC Session

Upon receiving a request from the PoC User to add one or more PoC Users to an ongoing PoC Session, the PoC Client:

- 1. SHALL generate an initial SIP REFER request as specified in subclause 6.1.3.1 "*General*" and according to rules and procedures of [RFC3515], if the SIP REFER request will be sent in a new dialog; otherwise generate a SIP REFER request according to rules and procedures of [RFC3515];
- 2. SHALL set the Request-URI of the SIP REFER request to the PoC Session Identity of an ongoing PoC Session;

NOTE 1: If the ongoing PoC Session is established using Pre-established Session but is not controlled by the same PoC Server, which hosts the Pre-established Session, the PoC Session Identity of the on-going PoC Session has been received in the MBCP Connect message.

- 3. SHALL perform the following actions, if only one PoC User is invited, either
 - a) set the Refer-To header of the SIP REFER request to the PoC Address of the Invited PoC User according to rules and procedures of [RFC3515] if the "copyControl" and the "anonymize" attributes are not used, and skip the next step; or
 - b) continue to the next step.

NOTE 2: If a PoC User wants to add a PoC User using a TEL URI the PoC Client can convert TEL URI to SIP URI according to [RFC3261], if needed.

- 4. SHALL perform the following actions:
 - a) include a Refer-To header with a pointer to an URI-list in a body part containing the MIME resource-lists body according to rules and procedures of [draft-multiple-refer];
 - b) include a MIME resource-lists body with the list of the PoC Users to be added according to rules and procedures of [draft-multiple-refer];
 - c) optionally, for each URI in the list, set the "copyControl" attribute to 'to', and set the "anonymize" attribute to 'true' if the URI is requested to be anonymous and not to be presented to Invited PoC Users, according to rules and procedures of [draft-URI-list-capacity]; and,
 - d) include option tag 'multiple-refer' to the Require header according to rules and procedures of [draft-multiple-refer].
- 5. SHALL include the following according to rules and procedures of [RFC4488], when more than one PoC User is added:
 - a) the option tag 'norefersub' in the Require header; and,
 - b) the value 'false' in the Refer-Sub header.
- 6. MAY include the following according to rules and procedures of [RFC4488], when only one PoC User is added:
 - a) the option tag 'norefersub' in the Require header; and,
 - b) the value 'false' in the Refer-Sub header.
- 7. SHALL include value 'id' in a Privacy header according to rules and procedures of [RFC3325], if anonymity is requested;

NOTE 3: If anonymity is not allowed for the PoC Group indicated with the Request-URI of the SIP REFER request based on rules specified in the [OMA-PoC-Documents-Mgmt] the PoC User(s) will not be added to the PoC Session by the PoC Server hosting the PoC Group.

- 8. SHALL include in the Refer-To URI a Priv-Answer-Mode header with the value 'Auto' according to rules and procedures of [draft-answer-mode] if the PoC User has requested manual answer override;
- 9. SHALL include in the Refer-To URI an Answer-Mode header with the value 'Manual;Require' according to rules and procedures of [draft-answer-mode] if the PoC User has requested that Manual Answer Mode be required at the Invited PoC Client;
- 10. SHOULD include a Resource-Priority header according to rules and procedures of [RFC4412], if the PoC Client is using 'Official Government Use' as the Local QoE Profile for the on-going PoC Session. If included, the value of the Resource-Priority header SHALL be equal to the level of priority assigned to the PoC User, as specified in subclause 5.8 "QoE Profiles"; the Resource-Priority header is included as a header of the REFER request as well as a Refer-to URI parameter; and,
- 11. SHALL send the SIP REFER request towards the PoC Server within the existing dialog from which the PoC Session Identity of the ongoing PoC Session was received in the Contact header of the SIP final response if such a dialog exists, otherwise send the SIP REFER request towards the PoC Server using a new SIP dialog according to rules and procedures of the SIP/IP Core.

NOTE 4: The SIP REFER request is sent using a new SIP dialog in case of Pre-established Session if the PoC Session Identity is different from Pre-established Session identity.

Upon receiving an incoming SIP NOTIFY request that is part of the same dialog as the previously sent SIP REFER request the PoC Client:

- 1. SHALL handle the request according to rules and procedures of [RFC3515] and [RFC3265]; and,
- 2. MAY display information to the PoC User based on the information in the SIP NOTIFY body.

NOTE 5: The PoC Server does not send any SIP NOTIFY request if the PoC Client inserted the Refer-Sub header with value 'false' in the SIP REFER request.

When the SIP/IP Core corresponds with 3GPP/3GPP2 IMS, the PoC Client SHALL use 3GPP/3GPP2 IMS mechanisms according to rules and procedures of [3GPP TS 24.229] / [3GPP2 X.S0013.4] with the clarifications given in this subclause.

6.1.8 PoC Client sending an Instant Personal Alert

Upon a request from a PoC User to send an Instant Personal Alert with a PoC Address identifying the receiving PoC Client, the PoC Client:

- 1. SHALL generate a SIP MESSAGE request according to rules and procedures of [RFC3428];
- 2. SHALL include Request-URI with the PoC Address of the PoC User to be alerted;
- 3. SHALL include the PoC Address of the PoC User in the Authenticated Originator's PoC Address as specified in subclause 5.2 "*Authenticated Originator's PoC Address*";
- 4. SHALL include an Accept-Contact header with the PoC feature tag, '+g.poc.talkburst' along with 'require' and 'explicit' parameters according to rules and procedures of [RFC3841];
- 5. SHALL include the User-Agent header to indicate the OMA PoC release version of the PoC Client as specified in subclause E.4.1 "*Release version in User-agent and Server headers*";

NOTE 1: The value of the content-type is outside the scope of this specification.

- 6. SHALL send the SIP MESSAGE request towards the PoC Server according to rules and procedures of the SIP/IP Core.

NOTE 2: Privacy cannot be applied with the Instant Personal Alert. If anonymity is required by the sending PoC User then the Instant Personal Alert should not be sent, because the PoC Server will reject the request.

When the SIP/IP Core corresponds with 3GPP/3GPP2 IMS, the PoC Client SHALL use 3GPP/3GPP2 IMS mechanisms, according to rules and procedures of [3GPP TS 24.229] / [3GPP2 X.S0013.4] with the clarifications given in this subclause.

6.1.9 PoC Client sending a Group Advertisement

Upon a request from a PoC User to send a Group Advertisement and if PoC Client supports Group Advertisement, the PoC Client:

- 1. SHALL generate a SIP MESSAGE request according to rules and procedures of [RFC3428];
- 2. SHALL include an Accept-Contact header with the PoC feature tag '+g.poc.groupad' along with 'require' and 'explicit' parameters according to rules and procedures of [RFC 3841];
- 3. SHALL include PoC specific content in the form of MIME vnd.poc.group-advertisement+xml body as defined in [OMA-PoC-Document-Mgmt] "*Group Advertisement*".
- 4. SHALL set the Request-URI according to the PoC User's selection to a PoC Address of a PoC User, or to a PoC Group Identity identifying a Chat PoC Group or a Pre-arranged PoC Group, or to an Exploder-URI identifying a SIP MESSAGE URI-list service according to rules and procedures of [draft-uri-list-message], if the Exploder-URI is provisioned for PoC Client;
- 5. SHALL include the PoC Address of the PoC User in the Authenticated Originator's PoC Address as specified in subclause 5.2 "*Authenticated Originator's PoC Address*";

- 6. SHALL include the User-Agent header to indicate the OMA PoC release version of the PoC Client as specified in subclause E.4.1 "*Release version in User-agent and Server headers*";
- 7. MAY include media content in one or more MIME body as specified in [RFC2046] with a total size equal to or less than the maximum size indicated in "INCLUDED-MEDIA-CONTENT-SIZE";

NOTE 1: If "INCLUDED-MEDIA-CONTENT-SIZE" is not provisioned or if "INCLUDED-MEDIA-CONTENT-SIZE" is provisioned and set to zero a MIME body with a Media Type specified in [RFC2046] can not be included.

NOTE 2: Privacy cannot be applied with Group Advertisement. If anonymity is requested by the sending PoC User, the Group Advertisement should not be sent, because the PoC Server will reject the request.

- 8. MAY include text content in the Subject header in SIP MESSAGE request as specified in [RFC3261] with a total size equal to or less than the maximum size indicated in "INCLUDED-TEXT-CONTENT-SIZE";

NOTE 3: If "INCLUDED-TEXT-CONTENT-SIZE" is not provisioned or if "INCLUDED-TEXT-CONTENT-SIZE" is provisioned and set to zero text content as specified in [RFC3261] can not be included.

- 9. MAY include a reference to media content in Call-Info header according to rules and procedures in [RFC3261]; and,
- 10. SHALL send the SIP MESSAGE request towards the PoC Server according to the procedures of the SIP/IP Core.

When the SIP/IP Core corresponds with 3GPP/3GPP2 IMS, the PoC Client SHALL use 3GPP/3GPP2 IMS mechanisms according to rules and procedures of [3GPP TS 24.229] / [3GPP2 X.S0013.4] with the clarifications given in this subclause.

6.1.10 PoC Client subscription to the conference state event package

A PoC Client MAY subscribe to the conference state event package by sending a SIP SUBSCRIBE request to obtain information of the status of a PoC Session.

When subscribing to the conference state event package, the PoC Client:

- 1. SHALL generate a SIP SUBSCRIBE request and use a new SIP-dialog, as specified in subclause 6.1.3.1 "*General*" and according to rules and procedures of [RFC3265] and [RFC4575];
- 2. SHALL set the Request-URI of the SIP SUBSCRIBE request to PoC Session Identity or the PoC Group Identity;
- 3. SHOULD include a Resource-Priority header according to rules and procedures of [RFC4412], if the PoC Client supports 'Official Government Use QoE Profile and the PoC User requests the priority treatment of the QoE Profile. If included, the value of the Resource-Priority header SHALL be equal to the level of priority assigned to the PoC User, as specified in subclause 5.8 "*QoE Profiles*"; and,
- 4. SHALL send the SIP SUBSCRIBE request towards the PoC Server using a new SIP dialog, according to rules and procedures of the SIP/IP Core.

The responses to the SIP SUBSCRIBE request SHALL be handled according to rules and procedures of [RFC3265] and [RFC4575], and rules and procedures of the SIP/IP Core with the clarifications given in this subclause.

Upon receiving a SIP 200 "OK" or a SIP 202 "Accepted" response to the SIP SUBSCRIBE request the PoC Client:

- 1. SHALL cache the address of the PoC Server received in the Contact header.

Upon receiving an incoming SIP NOTIFY request that is part of the same SIP dialog as the previously sent SIP SUBSCRIBE request the PoC Client:

- 1. SHALL handle the request according to rules and procedures of [RFC3265] and [RFC4575]; and,
- 2. MAY display the current state information of the PoC Session or PoC Group to the PoC User based on the information in the SIP NOTIFY request body.

NOTE: The PoC Client which requested privacy can find out its Anonymous PoC Address in the XML attribute "entity" of the XML element "user" with the XML attribute "yourown" equal to "true" as specified in [OMA-IM-TS_Endorsement] "*Conference Event Package*".

When needed the PoC Client SHALL terminate the subscription and indicate it terminated according to rules and procedures of [RFC3265].

The contents of the SIP NOTIFY request body is specified in subclause 7.2.1.11.2 "*Generating a SIP NOTIFY request*".

When the SIP/IP Core corresponds with 3GPP/3GPP2 IMS, the PoC Client SHALL use 3GPP/3GPP2 IMS mechanisms according to rules and procedures of [3GPP TS 24.229] / [3GPP2 X.S0013.4] with the clarifications given in this subclause.

6.1.11 PoC Client canceling a PoC Session

6.1.11.1 Canceling a PoC Session - On-demand Session case

When the PoC User wants to cancel the PoC Session initiation, when On-demand Session signaling is used as specified in subclause 6.1.3.3 "*Establishment of an On-demand Session*" and when the PoC Client has not yet received a final SIP response for the SIP INVITE request, the PoC Client SHALL cancel the SIP INVITE request acting as UAC according to rules and procedures of [RFC3261].

When the SIP/IP Core corresponds with 3GPP/3GPP2 IMS, the PoC Client SHALL use 3GPP/3GPP2 IMS mechanisms according to rules and procedures of [3GPP TS 24.229] / [3GPP2 X.S0013.4] with the clarifications given in this subclause.

6.1.12 Simultaneous PoC Session control procedures

The PoC Client MAY use Simultaneous PoC Session control procedures if Simultaneous PoC Sessions are supported by the Home PoC Network, if the provisioned parameter SIMU-SESNS specified in Appendix B "*The parameters to be provisioned for PoC service*" is greater than zero.

6.1.12.1 PoC Client setting PoC Session priority

The PoC Client MAY set a PoC Session priority while initiating a PoC Session with a SIP INVITE request or at any time later when a valid PoC Session exists with a SIP UPDATE or SIP re-INVITE request.

When the PoC User wants to set or change the PoC Session priority the PoC Client:

- 1. SHALL generate an a SIP INVITE request, SIP re-INVITE request or SIP UPDATE request as specified in subclause 6.1.3 "*PoC Session initiation*", subclause 6.1.5 "*PoC Client rejoining a PoC Session*" or subclause 6.1.4 "*PoC Client PoC Session modification*";

NOTE 1: The SIP request generation also includes SDP offer generation as specified in subclause 6.1.3.1a "*SDP offer generation*".

- 2. SHALL include the PoC Session parameter "poc_sess_priority" into the SIP request MIME SDP body for each offered Media-floor Control Entity according to subclause E.3.1 "*Media Burst Control Protocol MIME registration*"; and,

NOTE 2: The value of "poc_sess_priority" is the same for all the Media-floor Control Entities of the PoC Session.

- 3. SHALL send the SIP request towards the PoC Server according to rules and procedures of the SIP/IP Core.

On receipt of the SIP 200 "OK" response the PoC Client:

- 1. SHALL take account the parameter "poc_sess_priority" in the SDP answer; and,
- 2. SHALL interact with the User Plane as specified in [OMA-PoC-UP] "*Simultaneous PoC Sessions*".

NOTE 3: If a SIP 200 "OK" response is not received the PoC Client continues to use the previously agreed setting.

The PoC Client MAY indicate the PoC Session priority and PoC Session locking setting in the same SIP request.

When the SIP/IP Core corresponds to 3GPP/3GPP2 IMS, the PoC Client SHALL use 3GPP/3GPP2 IMS mechanisms according to rules and procedures of [3GPP TS 24.229] / [3GPP2 X.S0013.4] with the clarifications given in this subclause.

6.1.12.2 PoC Client handling of PoC Session locking

The PoC Client MAY request to lock itself in a particular PoC Session while initiating a PoC Session with a SIP INVITE request or at any time later when a valid PoC Session exists with a SIP UPDATE or a SIP re-INVITE request.

When the PoC User wants to set or change PoC Session locking state the PoC Client:

- 1. SHALL generate a SIP INVITE request, SIP re-INVITE request or SIP UPDATE request as specified in 6.1.3 "PoC Session initiation", subclause 6.1.5 "PoC Client rejoining a PoC Session" or subclause 6.1.4 "PoC Client PoC Session modification";

NOTE 1: The SIP request generation also includes SDP offer generation as specified in subclause 6.1.3.1a "SDP offer generation".

- 2. SHALL include the PoC Session locking parameter "poc_lock" into the SIP request MIME SDP body for each offered Media-floor Control Entity according to subclause E.3.1 "Media Burst Control Protocol MIME registration"; and,

NOTE 2: The value of "poc_lock" is the same for all the Media-floor Control Entities of the PoC Session.

- 3. SHALL send the request towards the PoC Server according to rules and procedures of the SIP/IP Core.

On receipt of the SIP 200 "OK" response the PoC Client:

- 1. SHALL take account the parameter "poc_lock" in the SDP answer; and,
- 2. SHALL interact with the User Plane as specified in [OMA-PoC-UP] "Simultaneous PoC Sessions".

NOTE 3: If a SIP 200 "OK" response is not received the PoC Client continues to use the previously agreed setting.

NOTE 4: The PoC Session locking is automatically released when the PoC Session is ended.

The PoC Client MAY indicate PoC Session priority and PoC Session locking setting in the same SIP request.

NOTE 5: If the PoC Client indicates PoC Session priority and PoC Session locking setting in the same SIP request, PoC Session locking has precedence over PoC Session priority when those apply.

When the SIP/IP Core corresponds to 3GPP/3GPP2 IMS, the PoC Client SHALL use 3GPP/3GPP2 IMS mechanisms according to rules and procedures of [3GPP TS 24.229] / [3GPP2 X.S0013.4] with the clarifications given in this subclause.

6.1.13 PoC Client expels Participant(s) from a PoC Session

Upon receiving a request from the PoC User to expel one or more Participants from an ongoing PoC Session, the PoC Client:

- 1. SHALL generate an initial SIP REFER request as specified in subclause 6.1.3.1 "General" and according to rules and procedures of [RFC3515], if the SIP REFER request will be sent in a new dialog; otherwise generate a SIP REFER request according to rules and procedures of [RFC3515];
- 2. SHALL set the Request-URI of the SIP REFER request to the PoC Session Identity of an ongoing PoC Session;

NOTE 1: If the ongoing PoC Session is established using Pre-established Session but it is not controlled by the same PoC Server, which hosts the Pre-established Session, the PoC Session Identity of the on-going PoC Session has been received in the MBCP Connect message.

- 3. SHALL perform the following actions, if only one Participant is expelled, either

NOTE 2: This is either a case when another Participant is expelled from a PoC Session or the release initiator leaves a PoC Session.

- a) if the Participant to be expelled is not an anonymous one, then set the Refer-To header of the SIP REFER request to the PoC Address of the expelled Participant according to rules and procedures of [RFC3515], otherwise set the Refer-To header of the SIP REFER request to the Anonymous PoC Address of the expelled Participant and skip the next step; or
- b) continue to the next step.
- 4. SHALL perform the following actions, if not all Participants are expelled:
 - a) include a Refer-To header with a pointer to an URI-list in a body part containing the MIME resource-lists body according to rules and procedures of [draft-multiple-refer];
 - b) include a MIME resource-lists body with the list of the PoC Users to be expelled according to rules and procedures of [draft-multiple-refer] if the Participant to be expelled is anonymous then the Anonymous PoC Address SHALL be used in the MIME resource-lists; and,
 - c) include 'multiple-refer' option tag to the Require header according to rules and procedures of [draft-multiple-refer].
- 5. SHALL include the "method" parameter with the value "BYE" in the Refer-To header;
- 6. SHALL include the following according to rules and procedures of [RFC4488], when more than one Participant is expelled:
 - a) the option tag 'norefersub' in the Require header; and,
 - b) the value 'false' in the Refer-Sub header.
- 7. SHOULD include the following according to rules and procedures of [RFC4488], when only one Participant is expelled:
 - a) the option tag 'norefersub' in the Require header; and,
 - b) the value 'false' in the Refer-Sub header.
- 8. SHOULD include a Resource-Priority header according to rules and procedures of [RFC4412], if the PoC Client supports 'Official Government Use' QoE Profile and the PoC User requests that QoE Profile. If included, the value of the Resource-Priority header SHALL be equal to the level of priority assigned to the PoC User according to their subscription, as specified in subclause 5.8 "*QoE Profiles*"; the Resource-Priority header is included as a header of the SIP REFER request as well as a Refer-to uri parameter; and,
- 9. SHALL include value 'id' in a Privacy header according to rules and procedures of [RFC3325], if anonymity is requested; and,

NOTE 3: If anonymity is not allowed for the PoC Group indicated with the Request-URI of the SIP REFER request based on rules specified in the [OMA-PoC-Document-Mgmt] the expelling will be rejected by the PoC Server hosting the PoC Group.

- 10. SHALL send the SIP REFER request towards the PoC Server within the existing dialog from which the PoC Session Identity of the ongoing PoC Session was received in the Contact header of the SIP final response if such a dialog exists, otherwise send the SIP REFER request towards the PoC Server using a new SIP dialog according to rules and procedures of the SIP/IP Core.

NOTE 4: If a PoC User wants to expel another Participant from the PoC Session, the PoC Client uses SIP URI when sending a SIP request. In that case the expelling PoC Client can convert TEL URI to SIP URI according to [RFC3261], if needed.

Upon receiving an incoming SIP NOTIFY request that is part of the same dialog as the previously sent SIP REFER request the PoC Client:

- 1. SHALL handle the request according to rules and procedures of [RFC3515] and [RFC3265]; and,
- 2. MAY display information to the PoC User based on the information in the SIP NOTIFY body.

NOTE 5: The PoC Server does not send any SIP NOTIFY request if the PoC Client inserted the Refer-Sub header with value 'false' in the SIP REFER request.

When the SIP/IP Core corresponds with 3GPP/3GPP2 IMS, the PoC Client SHALL use 3GPP/3GPP2 IMS mechanisms according to rules and procedures of [3GPP TS 24.229] / [3GPP2 X.S0013.4] with the clarifications given in this subclause.

6.1.14 PoC Dispatcher transferring the PoC Dispatcher role

Upon receiving a request from the Active PoC Dispatcher of a Dispatch PoC Session to transfer the Dispatcher role to another PoC User, the PoC Client:

- 1. SHALL, if the SIP REFER request will be sent in a new dialog, generate an initial SIP REFER request as specified in subclause 6.1.3.1 "*General*" and according to rules and procedures of [RFC3515]; otherwise generate a SIP REFER request according to rules and procedures of [RFC3515];
- 2. SHALL set the Request-URI of the SIP REFER request to the PoC Session Identity of the ongoing Dispatch PoC Session;

NOTE 1: If the on-going PoC Session is established using Pre-established Session but it is not controlled by the same PoC Server, which hosts the Pre-established Session, the PoC Session Identity of the on-going PoC Session has been received in the MBCP Connect message.

- 3. SHALL, if the PoC Dispatcher role is to be transferred to an individual PoC Dispatcher, set the Refer-To header of the SIP REFER request to the PoC Address of the Invited PoC User according to rules and procedures of [RFC3515];
- 4. SHALL, if the PoC Dispatcher role is to be transferred to any available PoC Dispatcher of the Dispatch PoC Group, set the Refer-To header of the SIP REFER request to the PoC Group Identity identifying the Dispatch PoC Group, according to rules and procedures of [RFC3515];
- 5. SHALL include the following according to rules and procedures of [RFC4488]:
 - a) the option tag 'norefersub' in the Require header; and,
 - b) the value 'false' in the Refer-Sub header.
- 6. SHALL include in the Refer-To URI an Answer-Mode header with the value 'Manual;Require' according to rules and procedures of [draft-answer-mode];

NOTE 2: If a PoC User wants to use a TEL URI when transferring the PoC Dispatcher role to another PoC User the PoC Client can convert TEL URI to SIP URI according to [RFC3261].

- 7. SHALL include in the Refer-To URI an Accept-Contact header with the PoC Dispatcher feature tag '+g.poc.dispatcher' along with 'require' and 'explicit' parameters according to rules and procedures of [RFC3841];
- 8. SHOULD include a Resource-Priority header according to rules and procedures of [RFC4412], if the PoC Client supports 'Official Government Use' QoE Profile and the PoC User requests that QoE Profile. If included, the value of the Resource-Priority header SHALL be equal to the level of priority assigned to the PoC User according to their subscription, as specified in subclause 5.8 "*QoE Profiles*"; the Resource-Priority header is included as a header of the SIP REFER request as well as a Refer-to uri parameter; and,
- 9. SHALL send the SIP REFER request towards the PoC Server within the existing dialog from which the PoC Session Identity of the ongoing PoC Session was received in the Contact header of the SIP final response if such a dialog exists, otherwise send the SIP REFER request towards the PoC Server using a new SIP dialog according to rules and procedures of the SIP/IP Core.

Upon receiving an incoming SIP NOTIFY request that is part of the same dialog as the previously sent SIP REFER request the PoC Client:

- 1. SHALL handle the request according to rules and procedures of [RFC3515] and [RFC3265]; and,
- 2. SHALL display transfer success or fail information to the PoC Dispatch User based on the information in the SIP NOTIFY request body.

NOTE 3: After successfully transferring the PoC Dispatcher role, the former PoC Dispatcher participates as a PoC Fleet Member in the ongoing Dispatch PoC Session and can leave the Dispatch PoC Session without causing the release of the Dispatch PoC Session.

NOTE 4: After successfully transferring the PoC Dispatcher role for a Dispatch PoC Session with a Dispatch PoC Group, the PoC Client is supposed automatically to transfer the PoC Dispatcher role to the same PoC User for all the remaining Dispatch PoC Sessions associated with that Dispatch PoC Group.

When the SIP/IP Core corresponds with 3GPP/3GPP2 IMS, the PoC Client SHALL use 3GPP/3GPP2 IMS mechanisms according to rules and procedures of [3GPP TS 24.229] / [3GPP2 X.S0013.4] with the clarifications given in this subclause.

6.1.15 PoC Client sending a Discrete Media as a SIP MESSAGE

Upon a request from a PoC User to send a Discrete Media and when the SIP MESSAGE request is used, the PoC Client:

- 1. SHALL generate a SIP MESSAGE request as specified in [OMA_IM_TS_Endorsement] "*Sending SIP MESSAGE for Pager Mode*";
- 2. SHALL include an Accept-Contact header with the PoC feature tag, '+g.poc.discretemedia' according to rules and procedures of [RFC3841], if to be sent outside the SIP dialog used for the PoC Session; and,
- 3. SHALL send the SIP MESSAGE request towards the PoC Server according to rules and procedures of the SIP/IP Core.

NOTE 1: The SIP MESSAGE request is sent inside the existing SIP dialog to Participants of the PoC Session, if SIP MESSAGE request is to be routed to the PoC Box.

NOTE 2: If a SIP MESSAGE request is sent inside the existing SIP dialog, it may block for some time the receiving PoC Client from receiving SIP signalling in the same SIP dialog e.g. PoC Session modification or PoC Session release.

NOTE 3: Responses for the SIP MESSAGE request are described in [OMA_IM_TS_Endorsement].

When the SIP/IP Core corresponds with 3GPP/3GPP2 IMS, the PoC Client SHALL use 3GPP/3GPP2 IMS mechanisms according to rules and procedures of [3GPP TS 24.229] / [3GPP2 X.S0013.4] with the clarifications given in this subclause.

6.1.16 PoC Client releases a PoC Session

6.1.16.1 Releasing a PoC Session – On-demand Session case

When the Participant wants to release the PoC Session that has been established using On-demand Session signaling as specified in subclause 6.1.3.3 "*Establishment of an On-demand Session*" or as specified in subclause 6.1.5.1 "*On-demand Session establishment*", the PoC Client:

- 1. SHALL interact with the User Plane as specified in [OMA-PoC-UP] "*PoC Client procedures at PoC Session release*";
- 2. SHALL generate a SIP BYE request according to rules and procedures of [RFC3261];
- 3. SHALL set the Request-URI to the PoC Session Identity of the PoC Session to leave;
- 4. SHALL include value 'id' in the Privacy header according to rules and procedures of [RFC3325], if anonymity is requested;
- 5. SHOULD include a Resource-Priority header according to rules and procedures of [RFC4412], if the PoC Client is allowed to use the 'Official Government Use' QoE Profile and the PoC User requests that QoE Profile. If included, the value of the Resource-Priority header SHALL be equal to the level of priority assigned to the PoC User, as specified in subclause 5.8 "*QoE Profiles*"; and,
- 6. SHALL send a SIP BYE request towards PoC Server according to rules and procedures of SIP/IP Core.

Upon receiving a SIP 200 "OK" response to the SIP BYE request, the PoC Client SHALL interact with the User Plane as specified in [OMA-PoC-UP] "*PoC Client procedures at PoC Session release*".

When the SIP/IP Core corresponds to 3GPP/3GPP2 IMS, the PoC Client SHALL use 3GPP/3GPP2 IMS mechanisms according to rules and procedures of [3GPP TS 24.229] / [3GPP2 X.S0013.4] with the clarifications given in this subclause.

6.1.16.2 Releasing a PoC Session – Pre-established Session case

Upon receiving a request from a PoC User to release a PoC Session, the PoC Client:

- 1. SHALL interact with the User Plane as specified in [OMA-PoC-UP] "*PoC Client procedures at PoC Session release*" for releasing the granted permission to talk or for cancelling the queued Talk Burst Request;
- 2. SHALL generate a SIP REFER request according to rules and procedures of [RFC3515];
- 3. SHALL set the Request-URI of the SIP REFER request to the conference URI that identifies the Pre-established Session;
- 4. SHALL set the Refer-To header of the SIP REFER request to the PoC Session Identity to leave;

NOTE 1: The PoC Session Identity of the PoC Session to leave may have been received in the TBCP Connect message or in the SIP NOTIFY request associated with the SIP REFER request.

- 5. MAY include the following according to rules and procedures of [RFC4488]:
 - a) the option tag 'norefersub' in the Require header; and,
 - b) the value 'false' in the Refer-Sub header.
- 6. SHALL include the "method" parameter with the value "BYE" in the Refer-To header;
- 7. SHALL include value 'id' in the Privacy header according to rules and procedures of [RFC3325], if anonymity is requested;
- 8. SHOULD include a Resource-Priority header according to rules and procedures of [RFC4412], if the PoC Client is allowed to use the 'Official Government Use' QoE Profile and the PoC User requests that QoE Profile. If included, the value of the Resource-Priority header SHALL be equal to the level of priority assigned to the PoC User, as specified in subclause 5.8 "*QoE Profiles*"; the Resource-Priority header is included as a header of the REFER request as well as a Refer-to URI parameter; and,
- 9. SHALL send the SIP REFER request towards the PoC Server within the existing dialog from which the PoC Session Identity of the ongoing PoC Session was received in the Contact header of the SIP final response if such a dialog exists, otherwise send the SIP REFER request towards the PoC Server using a new SIP dialogue according to rules and procedures of the SIP/IP Core.

Upon receiving a SIP 2xx response to the SIP REFER request, the PoC Client :

- 1. SHALL handle it according to rules and procedures of [RFC3515] and [RFC3265]; and,
- 2. SHALL interact with the User Plane as specified in [OMA-PoC-UP] "*PoC Client procedures at PoC Session release*".

NOTE 2: If the Media Streams of the Pre-established Session were modified by the PoC Session initiation or a PoC Session modification, the PoC Client can initiate the Pre-established Session modification as specified in 6.1.4.8 "*Pre-established Session modification*" to restore the Media Streams used before the association of the PoC Session with the Pre-established Session.

Upon receiving an incoming SIP NOTIFY request that is part of the same dialog as the previously sent SIP REFER request the PoC Client:

- 1. SHALL handle the request according to rules and procedures of [RFC3515] and [RFC3265]; and,
- 2. MAY display information to the PoC User based on the information in the SIP NOTIFY request body.

When the SIP/IP Core corresponds to 3GPP/3GPP2 IMS, the PoC Client SHALL use 3GPP/3GPP2 IMS mechanisms according to rules and procedures of [3GPP TS 24.229] / [3GPP2 X.S0013.4] with the clarifications given in this subclause.

6.1.17 PoC Client sending an FDCFO Proceed SIP MESSAGE

Upon a request from a PoC User to send an FDCFO Proceed message, the PoC Client:

- 1. SHALL generate a SIP MESSAGE request according to rules and procedures of [RFC3428];
- 2. SHALL include the PoC Address of the PoC User in the Authenticated Originator's PoC Address as specified in subclause 5.2 "*Authenticated Originator's PoC Address*";
- 3. SHALL include the User-Agent header to indicate the OMA PoC release version of the PoC Client as specified in subclause E.4.1 "*Release version in User-agent and Server headers*";
- 4. SHALL include the Privacy header with the value "id" if privacy is requested;

- 5. SHALL include a list of full duplex voice call addresses in the form of Content-Type application/vnd.poc.fdcfo+xml body as specified in the subclause E.1.3 "*FDCFO Proceed Document*"; and,
- 6. SHALL send the SIP MESSAGE request towards the PoC Server inside the SIP dialog used for the PoC Session according to rules and procedures of the SIP/IP Core.

NOTE 1: After the PoC Client receives the SIP 2xx final response, the full duplex voice client collocated with the PoC Client initiates the full duplex voice call to one of the full duplex voice call addresses.

After receiving the SIP 2xx final response to the SIP MESSAGE request, the PoC Client:

- 1. SHOULD release the PoC Session as specified in subclause 6.1.6 "*PoC Client leaving a PoC Session*"; or,
- 2. SHOULD remove the PoC Speech from the PoC Session as specified in subclause 6.1.4.6 "*Adding and disconnecting from Media*" if other Media Types than PoC Speech are used in the PoC Session.

NOTE 2: The timing of the PoC Session release and the PoC Session modification is not specified in detail, the PoC Session release or the PoC Session modification can be postponed until after the full duplex voice client collocated with the PoC Client successfully establishes the full duplex voice call

When the SIP/IP Core corresponds with 3GPP/3GPP2 IMS, the PoC Client SHALL use 3GPP/3GPP2 IMS mechanisms according to rules and procedures of [TS24.229] / [3GPP2 X.S0013.4] with the clarifications given in this subclause.

6.2 PoC Client termination procedures

6.2.1 PoC Client invited to a PoC Session

6.2.1.1 General

NOTE 1: This subclause provides common procedures for other subclauses and is not meant to be applied unless referenced.

Upon receiving a SIP re-INVITE request within a Pre-established Session without associated PoC Session or upon receiving an initial SIP INVITE request, the PoC Client:

- 1. MAY reject the SIP INVITE request or the SIP re-INVITE request within a Pre-established Session with an appropriate reject code as specified in [RFC3261] e.g.
 - a) when the PoC Client is occupied in another PoC Session and can not handle Simultaneous PoC Sessions as specified in 6.2.7 "*Simultaneous PoC Sessions control procedures*"; or,
 - b) when the PoC Client is occupied in a CS call; or,
 - c) when the PoC Client determines that there is not enough resources to handle the PoC Session; or,
 - d) any other reason outside the scope of this specification.

NOTE 2: The decision to reject a SIP INVITE request to a PoC Session can e.g. be based on procedures between the PoC Client and the PoC User outside the scope of this specification.

- 2. SHALL reject the initial SIP INVITE request with a SIP 403 "Forbidden" response if either of the following conditions are true:
 - a) the incoming SIP INVITE request contained a Priv-Answer-Mode header with the value 'Auto' as specified in [draft-answer-mode] and the PoC Client does not support manual answer override;
 - b) the incoming SIP INVITE request contained an Answer-Mode header with the value 'Manual;Require' as specified in [draft-answer-mode] and the PoC Client does not support Manual Answer Mode;

NOTE 3: A SIP re-INVITE request cannot include an Answer-Mode header as specified in [draft-answer-mode] so Manual Answer is implied when a SIP re-INVITE request is received within the existing SIP dialog of the Pre-established Session.

- 3. SHALL cache the list of supported SIP methods if received in the Allow header;
- 4. SHALL cache as the PoC Session Identity the content of the Contact header;
- 5. MAY display to the PoC User the PoC Address of the Inviting PoC User but SHALL NOT display it if Privacy header includes value 'id';
- 6. MAY render to the PoC User the identities which are indicated to be shown and the total number of anonymous PoC Users invited to the Ad-hoc PoC Group Session and 1-1 PoC Session, if indicated in the MIME resource-lists body in the request;
- 7. MAY display Session Type information to the PoC User based on the information received in the Session-Type uri-parameter in the Contact header;
- 8. MAY notify the Media Burst Control Scheme to the PoC User if received the indication of Media Burst Control Scheme;
- 9. MAY check if a Resource-Priority header is included in the incoming SIP INVITE request and can perform further actions associated with the SIP/IP Core and Access Network outside the scope of this Specification to act upon an included Resource-Priority header, if 'Official Government Use' QoE Profile is supported;
- 10. SHOULD render the media content received in MIME bodies to the PoC User if media content in a request is supported and the Media Type is supported by the PoC Client;
- 11. SHOULD render the text content in Subject header to the PoC User if text is included in the Subject header and if Text Content is supported by the PoC Client; and,
- 12. SHOULD retrieve and render the referenced media content in the Alert-Info header or in the Call-Info header or both according to rules and procedures of [RFC 3261] if a reference is included in the Alert-Info header or in the Call-Info header or in both, and if Referenced Media Content and referenced Media Type(s) are supported by the PoC Client.

When generating SIP provisional responses other than the SIP 100 "Trying" or SIP 2xx final responses to the received initial SIP request or the SIP re-INVITE request within a Pre-established Session the PoC Client:

- 1. SHALL generate SIP responses according to rules and procedures of [RFC3261];

NOTE 4: The use of the option tag 'precondition', as specified in [RFC3312], and the option tag '100rel', as specified in [RFC3262], is not defined for the POC-1 reference point.

- 2. SHALL include Server header to indicate the OMA PoC release version of the PoC Client as specified in subclause E.4.1 "*Release version in User-agent and Server headers*";
- 3. SHALL include the option tag 'timer' in a Require header;
- 4. SHOULD include an Allow header with the SIP methods supported in this SIP dialog according to rules and procedures of [RFC3261];
- 5. SHALL include value 'id' in a Privacy header according to rules and procedures specified in [RFC3325], if anonymity is requested by the Invited PoC User;
- 6. SHALL include the Session-Expires header in the SIP 200 "OK" response to the initial SIP INVITE request or the SIP re-INVITE request within a Pre-established Session and start the SIP Session timer according to rules and procedures specified in [RFC4028], "*UAS Behavior*". The "refresher" parameter in the Session-Expires header SHALL be set to 'uas'.
- 7. SHALL include the PoC Address of the PoC User as the Authenticated Originator's PoC Address as specified in subclause 5.2 "*Authenticated Originator's PoC Address*", if not provided automatically by SIP/IP Core;
- 8. SHALL include the PoC feature tag '+g.poc.talkburst' in the Contact header;
- 9. SHALL include the PoC feature tag '+g.poc.fdcfo' in the Contact header if the FDCFO Proceed feature is supported;
- 10. SHALL include the PoC feature tag '+g.poc.discretemedia' in the Contact header of the SIP 200 "OK" response, if Discrete Media is supported and acceptable to the PoC User during the PoC Session;
- 11. MAY include a Nick Name and, if included, SHALL be included as specified in subclause 5.4 "*Nick Name*" in the SIP 200 "OK" response to the initial SIP INVITE request;

- 12. SHALL include an Accept-Language header in the SIP 2xx final response to indicate the language to be used by the PoC Server for the texts sent to the PoC Client if the PoC Client wishes to get the texts in a language different than default.

When NAT traversal is supported by the PoC Client and when the PoC Client is behind NAT generation of SIP responses is done as specified in this subclause and as specified in [sip-outbound].

When the SIP/IP Core corresponds with 3GPP/3GPP2 IMS, the PoC Client SHALL use 3GPP/3GPP2 IMS mechanisms according to rules and procedures of [3GPP TS 24.229] / [3GPP2 X.S0013.4] with the clarifications given in this subclause.

6.2.1.1a SDP answer generation

When PoC Client receives an initial SDP offer for a PoC Session, the PoC Client SHALL accept or reject each Media Stream according to rules and procedures of [RFC3264].

When PoC Client receives an SDP offer, which removes a Media Stream from the existing PoC Session, the PoC Client SHALL accept each Media Stream removal in the SDP answer according to rules and procedures of [RFC3264]. The PoC Client SHOULD accept PoC Speech, if offered in the PoC Group Session SDP offer.

NOTE 1: If an offered Media Type is not accepted in the Automatic Answer Mode, the PoC Server performing the Controlling PoC Function can still accept the Media Type to the Inviting PoC Client which can potentially result in Media loss.

When PoC Client receives an SDP offer, which offers adding new Media Stream in the existing PoC Session, the PoC Client SHALL accept or reject each new Media Stream according to rules and procedures of [RFC3264].

When composing an SDP answer according to rules and procedures of [RFC3264] and [RFC4566] the PoC Client:

- 1. SHALL set the IP address of the PoC Client for each accepted Media Stream and for each accepted Media-floor Control Entity;

NOTE 2: If the PoC Client is behind NAT the IP address and port can be a different IP address and port than the one of the PoC Client depending on NAT traversal method used by SIP/IP Core.

- 2. SHALL include the media-level section for each accepted Media from the SDP offer consisting of:
 - a) the port number for Media Stream selected as specified in [OMA-PoC-UP] "*Port numbers*";
 - b) the codec(s) and Media Parameters acceptable by the PoC Client for the PoC Service selected from those in the SDP offer contained in the incoming SIP INVITE request or the SIP re-INVITE request within a Pre-established Session;

NOTE 3: The Media Parameters of the Discrete Media are defined in [OMA_IM_TS_Endorsement].

- c) the "a=label" attribute with a unique value as specified in [RFC4574], if the Media Stream is to be connected to a Media-floor Control Entity and except when only PoC Speech with Talk Burst Control Protocol as specified in [OMA-POC-1-UP] is accepted;
- d) the IP address of the PoC Client and port number to be used for RTCP selected as specified in [OMA-PoC-UP] "*Port numbers*", according to rules and procedures of [RFC3605], if the Media Stream uses the RTCP protocol and other than the default IP address or port number specified by the [RFC3550] is to be used;
- e) under the media level definition of MSRP, add to "a=accept-types:" SDP attribute MIME Types "application/vnd.oma.poc.final-report+xml", "application/vnd.oma.poc.detailed-progress-report+xml" and "application/vnd.oma.poc.optimized-progress-report+xml" if included in the received SDP offer and if supported by the PoC Client;

NOTE 4: Includes an "a=sendonly" attribute for a media component if the Media Stream is placed on hold as specified in 6.1.4.2 "*PoC Client placing media on hold*".

- f) include the "a=setup:active" attribute and the "a=connection:new" attribute according to rules and procedures of [RFC4145] if a "a=setup:passive" or "a=setup:actpass" attribute was received in the SDP offer and if the

PoC Client will establish a new TCP connection for this PoC Session, if the PoC Client supports NAT traversal according to [RFC4145] and;

g) include the "a=setup: active" attribute and the "a=connection:existing" attribute according to rules and procedures of [RFC4145] if a "a=setup:passive" or "a=setup:actpass" attribute was received in the SDP offer and if the PoC Client will use an existing TCP connection for this PoC Session, if the PoC Client supports NAT traversal according to [RFC4145].

- 3. SHALL include for any Media-floor Control Entity, that is offered in the SDP offer and accepted in the SDP answer, the media-level section of each offered Media-floor Control Entity consisting of:
 - a) the format list field for the Media-floor Control Entity is set to "TBCP";
 - b) the Media-floor Control Entity parameters selected from those in the SDP offer contained in the SIP INVITE request or the SIP re-INVITE request within a Pre-established Session, including if needed the TBCP MIME parameter "multimedia" with the appropriated value as specified in E.3 "SDP Extensions";
 - c) the port number for Media-floor Control Entity selected as specified in [OMA-PoC-UP] "Port numbers"; and,
 - d) the "a=floorid:0 mstrm" attribute with value(s) referencing the Media Stream as specified in [RFC4583] intended to be connected the Media-floor Control Entity except when only PoC Speech with Talk Burst Control Protocol as specified in [OMA-POC-1-UP] is accepted;
- 4. SHALL mark as rejected according to rules and procedures of [RFC3264] the Media-floor Control Entity and all the Media Streams bound to the rejected Media-floor Control Entity, if the Media-floor Control Entity is either rejected or not supported;
- 5. SHALL mark as rejected according to rules and procedures of [RFC3264] the Media Streams rejected or not supported;
- 6. SHOULD include a QoE Profile attribute, as specified in subclause E.3.2 "QoE Profile" with the following value, if QoE Profiles are provisioned to the PoC Client:
 - a) the value of the Local QoE Profile corresponding to the QoS achieved by the PoC Client for the PoC Session if the SDP answer is used in the modification of a PoC Session.
 - b) the value of the Local QoE Profile for the PoC Session in other case. The chosen Local QoE Profile SHOULD be equal to the QoE Profile indicated in the received SDP offer, if allowed according to the QoE Profiles provisioned to the PoC Client. Otherwise it SHOULD be the highest QoE Profile provisioned to the PoC Client.

When composing an SDP answer, the PoC Client:

- 1. SHALL bind the media-level section that identifies PoC Speech to the corresponding Media-floor Control Entity as in the SDP offer, if PoC Speech is accepted;
- 2. SHALL bind the media-level section that identifies Video to the corresponding Media-floor Control Entity as in the SDP offer, if Video is accepted;
- 3. SHALL bind the media-level section that identifies Audio to the corresponding Media-floor Control Entity as in the SDP offer, if Audio is accepted; and
- 4. SHALL bind the media-level section that identifies Discrete Media to the corresponding Media-floor Control Entity as in the SDP offer, if Discrete Media is accepted and bound to the Media-floor Control Entity.

When the SIP/IP Core corresponds to 3GPP/3GPP2 IMS, the PoC Client SHALL use 3GPP/3GPP2 IMS mechanisms according to rules and procedures of [3GPP TS 24.229] / [3GPP2 X.S0013.4] with the clarifications given in this subclause.

6.2.1.2 Auto-answer case

Upon receiving an initial SIP INVITE request, the PoC Client SHALL perform the auto-answer procedures described in this subclause if any of the following conditions are true:

- the incoming SIP INVITE request contained an Answer-Mode header with the value 'Auto' as specified in [draft-answer-mode] and the PoC Client is set to Automatic Answer Mode; or
- the incoming SIP INVITE request contained a Priv-Answer-Mode header with the value 'Auto' as specified in [draft-answer-mode], and the PoC Client does not already have an established PoC Session;

otherwise, do not continue with the rest of the steps in this subclause.

The PoC Client:

- 1. SHALL validate that the Media Parameters and at least one codec offered in the SIP INVITE request are acceptable to the PoC Client and if not, reject the request with a SIP 488 "Not Acceptable Here" response. Otherwise, continue with the rest of the steps;
- 2. SHALL, if the PoC Dispatcher or PoC Fleet Member capability is supported, check for the Dispatch Type uri-parameter according to subclause E.5.2 "*Dispatch Type uri-parameter*" in the Contact header. If it is present, the PoC Client:
 - a) SHOULD notify information about the type of Dispatch PoC Session to the PoC User based on the information received in the Dispatch Type uri-parameter; and,
 - b) SHOULD notify about the role to be adopted in the Dispatch PoC Session to the PoC User based on the presence or absence of an Accept-Contact header with the PoC Dispatcher feature tag '+g.poc.dispatcher'.

NOTE: The PoC Client is invited as PoC Fleet Member to a Dispatch PoC Session when the Dispatch Type uri-parameter is received but the PoC Dispatcher feature tag is not received in the initial invitation. The PoC Client is invited as PoC Dispatcher to a Dispatch PoC Session when both the Dispatch Type uri-parameter and the PoC Dispatcher feature tag are received in the initial invitation.

- 3. SHALL accept the request and generate a SIP 200 "OK" response as specified in the subclause 6.2.1.1 "*General*" towards the PoC Server;
- 4. SHALL include in a SIP 200 "OK" response a MIME SDP body as an SDP answer to the SDP offer in the incoming SIP INVITE request as specified in the subclause 6.2.1.1a "*SDP answer generation*";
- 5. SHALL, if the PoC Dispatcher capability is supported, check the presence in the SIP INVITE request of an Accept-Contact header with the PoC Dispatcher feature tag '+g.poc.dispatcher' along with 'require' and 'explicit' parameters. If it is present, the PoC Client SHALL add the PoC Dispatcher feature tag '+g.poc.dispatcher' in the Contact header of the SIP 200 "OK" response.
- 6. SHALL send the SIP 200 "OK" response towards the PoC Server according to rules and procedures of the SIP/IP Core;
- 7. MAY notify the Media Burst Control Scheme to the PoC User if received the indication of Media Burst Control Scheme;
- 8. SHALL interact with the User Plane as specified in [OMA-PoC-UP] "*PoC Client procedures at PoC Session initialization*"; and,
- 9. SHOULD inform the PoC Server performing the Controlling PoC Function, as specified in section 6.1.4.4 "*User Plane Adaptation*", of the achieved QoE Profile, if a QoE Profile was negotiated and if the PoC Client is unable to obtain that negotiated QoE Profile according to the parameters provisioned to the PoC Client, as specified in subclause 5.8 "*QoE Profiles*".

When the SIP/IP Core corresponds with 3GPP/3GPP2 IMS, the PoC Client SHALL use 3GPP/3GPP2 IMS Session establishment mechanisms according to rules and procedures of [3GPP TS 24.229] / [3GPP2 X.S0013.4] with the clarifications given in this subclause.

6.2.1.3 Manual-answer case

Upon receiving an initial SIP INVITE request, if any of the following conditions are true:

- the incoming SIP INVITE request contained an Answer-Mode header with the value 'Manual;Require' as specified in [draft-answer-mode];
- the PoC Client is set to Manual Answer Mode and the incoming SIP INVITE request did not contain a Priv-Answer-Mode header with the value 'Auto' as specified in [draft-answer-mode]; or,
- the incoming SIP INVITE request contained a Priv-Answer-Mode header with the value 'Auto' as specified in [draft-answer-mode] and the PoC Client has an already established PoC Session

or upon receiving a SIP re-INVITE request within a Pre-established Session without associated PoC Session, the PoC Client:

- 1. SHALL validate that the Media Parameters and at least one codec offered in the SIP INVITE request/SIP re-INVITE request are acceptable to the PoC Client and if not, reject the request with a SIP 488 "Not Acceptable Here" response. Otherwise, continue with the rest of the steps;

- 2. SHOULD indicate to the PoC User if maximum amount of Simultaneous PoC Sessions are exceeded with this PoC Session in case Simultaneous PoC Sessions are supported. When accepting an incoming PoC Session invitation in case maximum amount of Simultaneous PoC Sessions are exceeded, one of the on-going PoC Sessions SHALL be released as described in the subclause 6.1.6 "*PoC Client leaving a PoC Session*";

NOTE 1: How the PoC Client interacts with the PoC User to determine which PoC Session to release is an implementation issue.

- 3. SHALL, if the PoC Dispatcher or PoC Fleet Member capability is supported, check for the Dispatch Type uri-parameter according to subclause E.5.2 "*Dispatch Type uri-parameter*" in the Contact header. If it is present, the PoC Client:
 - a) SHOULD notify information about the type of Dispatch PoC Session to the PoC User based on the information received in the Dispatch Type uri-parameter; and,
 - b) SHOULD notify about the role to be adopted in the Dispatch PoC Session to the PoC User based on the presence or absence of an Accept-Contact header with the PoC Dispatcher feature tag '+g.poc.dispatcher'.

NOTE 2: The PoC Client is invited as PoC Fleet Member to a Dispatch PoC Session when the Dispatch Type uri-parameter is received but the PoC Dispatcher feature tag is not received in the initial invitation. The PoC Client is invited as PoC Dispatcher to a Dispatch PoC Session when both the Dispatch Type uri-parameter and the PoC Dispatcher feature tag are received in the initial invitation.

- 4. SHALL generate a SIP 180 "Ringing" response as specified in the subclause 6.2.1.1 "*General*";
- 5. SHALL, if the PoC Dispatcher capability is supported, check the presence in the SIP INVITE request/SIP re-INVITE request of an Accept-Contact header with the PoC Dispatcher feature tag '+g.poc.dispatcher' along with 'require' and 'explicit' parameters. If it is present, the PoC Client SHALL add the PoC Dispatcher feature tag '+g.poc.dispatcher' in the Contact header of the SIP 180 'Ringing' response.
- 6. SHALL send the SIP 180 'Ringing' response to the PoC Server;
- 7. SHALL send a SIP 480 "Temporarily Unavailable" response towards the PoC Server if the PoC User declines the PoC Session invitation or a SIP 408 "Request Timeout" response if the invitation times out and do not continue with the rest of the steps;
- 8. SHALL send a SIP 302 "Moved Temporarily" response towards the PoC Server if the PoC User wants to redirect the invitation to a NW PoC Box and SHALL include the address of the NW PoC Box in the Contact header according to rules and procedures of [RFC3261] if the NW PoC Box address is provisioned in the PoC Client and if the NW PoC Box is supported by the PoC Client and provided there is no Reject-Contact header with the feature tags 'sip.automata' and 'sip.actor' with the value 'msg-taker' along with and 'require' and 'explicit' is not included in the initial SIP INVITE request. and do not continue with the rest of the steps.
- 9. SHALL perform the procedures specified in 8.3.1 "*UE PoC Box Invited to a PoC Session*", if the PoC User decides to have the UE PoC Box accept the PoC Session and do not continue with the rest of the steps;
- 10. SHALL generate a SIP 200 "OK" response to the SIP INVITE request/SIP re-INVITE request as specified in the subclause 6.2.1.1 "*General*" if the PoC User accepts the PoC Session invitation;
- 11. SHALL include in the SIP 200 "OK" response a MIME SDP body as an SDP answer to the SDP offer in the incoming SIP INVITE request/SIP re-INVITE request as specified in the subclause 6.2.1.1a "*SDP answer generation*";
- 12. SHALL, if the PoC Dispatcher capability is supported, check the presence in the SIP INVITE request/SIP re-INVITE request of an Accept-Contact header with the PoC Dispatcher feature tag '+g.poc.dispatcher' along with 'require' and 'explicit' parameters. If it is present, the PoC Client SHALL add the PoC Dispatcher feature tag '+g.poc.dispatcher' in the Contact header of the SIP 200 "OK" response;
- 13. SHALL send the SIP 200 "OK" response to the PoC Server;
- 14. SHALL interact with the User Plane as specified in [OMA-PoC-UP] "*PoC Client procedures at PoC Session initialization*";
- 15. MAY notify the Media Burst Control Scheme to the PoC User if the PoC User accepts the PoC Session invitation and the indication of Media Burst Control Scheme is received; and,
- 16. SHOULD inform the PoC Server performing the Controlling Function, as specified in subclause 6.1.4.4 "*User Plane Adaptation*", of the achieved QoE Profile, if a QoE Profile was negotiated and if the PoC Client is unable to

obtain that negotiated QoE Profile according to the parameters provisioned to the PoC Client, as specified in subclause 5.8 "*QoE Profiles*".

NOTE 3: If the PoC User is invited as PoC Fleet Member to a Dispatch PoC Session and the PoC Fleet Member capability is supported, it is recommended that the PoC Client sets the new Dispatch PoC Session to be the Primary PoC Session as specified in subclause 6.1.12.1 "*PoC Client setting PoC Session priority*".

When the SIP/IP Core corresponds with 3GPP/3GPP2 IMS, the PoC Client SHALL use 3GPP/3GPP2 IMS Session establishment mechanisms according to rules and procedures of [3GPP TS 24.229] / [3GPP2 X.S0013.4] with the clarifications given in this subclause.

6.2.2 PoC Client receiving a PoC Session modification request

6.2.2.1 General

NOTE 1: This subclause provides common procedures for other subclauses and is not meant to be applied unless referenced.

A PoC Client can receive a request to modify the existing PoC Session. The PoC Session modification can be due to changing Media Parameters, adding Media Streams to the PoC Session, removing Media Streams from the PoC Session or changing the bindings between Media Streams and Media-floor Control Entities.

NOTE 2: The handling of a SIP re-INVITE request for Pre-established Session without associated PoC Session is described in subclause 6.2.1 "*PoC Client invited to a PoC Session*".

Upon receiving a SIP UPDATE request, the PoC Client SHALL perform the actions as specified in subclause 6.2.2.2 "*PoC Client receiving a request for User plane adaptation*".

Upon receiving a SIP re-INVITE request with a MIME SDP body, the PoC Client:

- 1. SHALL perform the actions as specified in subclause 6.2.2.2 "*PoC Client receiving a request for User plane adaptation*", if the offered Media Streams are the same as Media Streams used by the PoC Client in the PoC Session and if the current Media-floor Control Entity binding of each Media used by the PoC Client and offered to the PoC Client is the same in the received SDP offer; or
- 2. SHALL perform the actions as specified in subclause 6.2.2.3 "*PoC Client receiving a request to add and disconnect Media*", if the offered Media Streams are not the same as Media Streams used by the PoC Client in the PoC Session or if the current Media-floor Control Entity binding of a Media used by the PoC Client and offered to the PoC Client is not the same as in the received SDP offer.

When the SIP/IP Core corresponds to 3GPP/3GPP2 IMS, the PoC Client SHALL use 3GPP/3GPP2 IMS mechanisms according to rules and procedures of [3GPP TS 24.229] / [3GPP2 X.S0013.4] with the clarifications given in this subclause.

6.2.2.2 PoC Client receiving a request for User plane adaptation

Upon receiving a SIP UPDATE request, or a SIP re-INVITE request with a MIME SDP body including a new SDP offer as specified by [RFC3264] and [RFC4566], the PoC Client:

- 1. SHALL validate that the Media Parameters and at least one codec are acceptable to the PoC Client and if not,
 - a) select a subset of the received Media Parameters; or,
 - b) reject the request with a SIP 488 "Not Acceptable Here" response towards the PoC Server according to rules and procedures of SIP/IP Core. Otherwise, continue with the rest of the steps;
- 2. SHALL interact with the User Plane as specified in [OMA-PoC-UP] "*User Plane adaptation*" for activating new Media Parameters;
- 3. SHALL generate a SIP 200 "OK" according to rules and procedures of [RFC3261];

- 4. SHALL include the Session-Expires header in the SIP 200 "OK" response to the SIP UPDATE or SIP re-INVITE request and re-start the SIP Session timer according to rules and procedures specified in [RFC4028], "*UAS Behavior*". The "refresher" parameter in the Session-Expires header SHALL be set to 'uas'.
- 5. SHALL include the option tag 'timer' in the Require header;
- 6. SHALL include the accepted Media Parameters in a MIME SDP body as the SDP answer to the SDP offer in the SIP UPDATE or SIP re-INVITE request as specified in the subclause 6.2.1.1a "*SDP answer generation*";
- 7. SHALL send the SIP 200 "OK" response towards the PoC Server according to rules and procedures of SIP/IPCore;
- 8. MAY notify the Media Burst Control Scheme to the PoC User if received the indication of Media Burst Control Scheme; and,
- 9. SHOULD inform the PoC Server performing the Controlling PoC Function, as specified in section 6.1.4.4 "*User Plane Adaptation*", of the achieved QoE Profile, if a QoE Profile was negotiated and if the PoC Client is unable to obtain that negotiated QoE Profile according to the parameters provisioned to the PoC Client, as specified in subclause 5.8 "*QoE Profiles*".

When the SIP/IP Core corresponds with 3GPP/3GPP2 IMS, the PoC Client SHALL use 3GPP/3GPP2 IMS mechanisms according to rules and procedures of [3GPP TS 24.229] / [3GPP2 X.S0013.4] with the clarifications given in this subclause.

6.2.2.3 PoC Client receiving a request to add and disconnect Media Streams

When PoC Client receives a request to add a new Media Stream to the existing PoC Session, to remove currently used Media Stream from the PoC Session, to change the Media-floor Control Entity binding of a used Media in the PoC Session or a combination of these, the PoC Client:

- 1. SHALL validate that the offered Media Streams are supported by the PoC Client, and mark the not supported Media Streams as rejected in the SDP offer according to rules and procedures of [RFC3264];
- 2. SHALL, for each offered Media Stream not yet rejected, validate that at least one offered codec or offered Media format is supported by the PoC Client, and if not, reject the particular Media Stream in the SDP offer according to rules and procedures of [RFC3264];
- 3. SHALL, for each offered Media Stream not yet rejected, validate that the Media Parameters are acceptable for the PoC Client and if not, reject the particular Media Stream in the SDP offer according to rules and procedures of [RFC3264];
- 4. SHALL reject the request with a SIP 488 "Not Acceptable Here" response towards the PoC Server according to rules and procedures of SIP/IP Core, if all offered Media Stream are rejected. Otherwise, continue with the rest of the steps;
- 5. SHALL, for the offered Media Stream, which were not yet rejected and which are not used currently or if the current Media-floor Control Entity binding of a Media used by the PoC Client and offered to the PoC Client is not the same as in the received SDP offer, either
 - a) prompt the request to the PoC User for acceptance if Manual Answer Mode is required by the PoC User for the offered Media Type. If the PoC User decides not to accept the Media Stream, reject the Media Stream in the SDP offer according to rules and procedures of [RFC3264];
 - b) reject the Media Stream in the SDP offer according to rules and procedure of [RFC3264]; or,
 - c) accept the Media Stream.

NOTE: A SIP re-INVITE request cannot include an Answer-Mode header as specified in [draft-answer-mode] so the PoC Server does not indicate whether the PoC Client is to accept the offered Media automatically or not based upon the <allow-auto-answer-mode> action associated to the Invited PoC User. The PoC Client therefore needs to determine whether to accept the offered Media automatically or not based upon the local preferences of the PoC User stored on the PoC Client.

- 6. SHALL generate SIP 200 "OK" response according to rules and procedures of [RFC3261];
- 7. SHALL include in the SIP 200 "OK" response an SDP answer to the SDP offer as specified in subclause 6.2.1.1a "*SDP answer generation*";
- 8. SHALL send the SIP 200 "OK" response towards the PoC Server according to rules and procedures of SIP/IP Core;

- 9. SHALL interact with User Plane as specified in [OMA-PoC-UP] "*User Plane adaptation*", if the SDP answer contains changes in the Media Parameters, Media formats or codecs compared to the previously agreed SDP;
- 10. SHALL interact with User Plane as specified in [OMA-PoC-UP] "*PoC Client procedures when disconnecting from a Media Type*", if the SDP answer contains a Media Stream, that is currently used by the PoC Client, marked as rejected or if the current Media-floor Control Entity binding of a Media used by the PoC Client and offered to the PoC Client is not the same as in the received SDP offer; and,
- 11. SHALL interact with User Plane as specified in [OMA-PoC-UP] "*PoC Client procedures when connecting to a Media Type*", if the SDP answer contains an accepted Media which is not currently used by the PoC Client in the PoC Session or if the current Media-floor Control Entity binding of a Media used by the PoC Client and offered to the PoC Client is not the same as in the received SDP offer.

When NAT traversal is supported by the PoC Client and when the PoC Client is behind NAT generation of SIP responses is done as specified in this subclause and as specified in [sip-outbound].

When the SIP/IP Core corresponds to 3GPP/3GPP2 IMS, the PoC Client SHALL use 3GPP/3GPP2 IMS mechanisms according to rules and procedures of [3GPP TS 24.229] / [3GPP2 X.S0013.4] with the clarifications given in this subclause.

6.2.3 PoC Client receiving a PoC Session release request

6.2.3.1 PoC Session release request – On-demand Session case

Upon receiving a SIP BYE request, the PoC Client:

- 1. SHALL interact with the User Plane as specified in [OMA-PoC-UP] "*PoC Client procedures at PoC Session release*"; and,

NOTE 1: Resulting User Plane processing is completed before the next step is performed.

NOTE 2: If the SIP BYE request contains a Reason header according to rules and procedures of [RFC 4411], the PoC Client can display a message to the PoC User containing the text from the Reason header.

- 2. SHALL send SIP 200 "OK" response towards PoC Server according to rules and procedures of the SIP/IP Core.

When the SIP/IP Core corresponds with 3GPP/3GPP2 IMS, the PoC Client SHALL use 3GPP/3GPP2 IMS mechanisms according to rules and procedures of [3GPP TS 24.229] / [3GPP2 X.S0013.4] with the clarifications given in this subclause.

6.2.3.2 PoC Session release request – Pre-established Session case

Upon receiving a release request on the User Plane as specified in [OMA-PoC-UP] "*PoC Session control state diagram – Pre-established Session*", the PoC Client SHALL regard the PoC Session within the Pre-established Session as released and interact with the User Plane as specified in [OMA-PoC-UP] "*PoC Client procedures at PoC Session release*".

NOTE: If the Media Streams of the Pre-established Session were modified by the PoC Session initiation or a PoC Session modification, the PoC Client can initiate the Pre-established Session modification in 6.1.4.8 "*Pre-established Session modification*" to restore the Media Streams used before the association of the PoC Session with the Pre-established Session.

6.2.4 PoC Client receiving an Instant Personal Alert

Upon receiving a SIP MESSAGE request containing the PoC feature tag '+g.poc.talkburst' in the Accept-Contact header field, and a non-anonymous Authenticated Originator's PoC Address, the PoC Client:

NOTE 1: The value of the content-type is outside the scope of this specification.

- 1. MAY reject the SIP MESSAGE request with an appropriate reject code specified in [RFC3428] and [RFC3261] e.g.
 - a) when the PoC Client determines that there is not enough resources to handle the SIP MESSAGE request; or,

b) any other reason outside the scope of this specification.

NOTE 2: The decision to reject the SIP MESSAGE request can e.g. be based on procedures between the PoC Client and the PoC User outside the scope of this specification.

Otherwise continue with the rest of the steps;

- 2. SHALL generate a SIP 200 "OK" response according to rules and procedures of [RFC3428];
- 3. SHALL include the Server header to indicate the OMA PoC release version of the PoC Client as specified in subclause E.4.1 "*Release version in User-agent and Server headers*";
- 4. SHALL send the SIP 200 "OK" response towards the PoC Server according to rules and procedures of the SIP/IP Core; and,
- 5. MAY indicate to the PoC User that an Instant Personal Alert was received.

The PoC Client MAY use the procedures specified in subclause 6.1.3.2.2 "*PoC Client initiates an Ad-hoc PoC Group Session and 1-1 PoC Session*" or in subclause 6.1.3.3.1 "*PoC Client initiates an Ad-hoc PoC Group Session and 1-1 PoC Session*" to initiate a 1-1 PoC Session with the PoC User identified in the Authenticated Originator's PoC Address.

When the SIP/IP Core corresponds with 3GPP/3GPP2 IMS, the PoC Client SHALL use 3GPP/3GPP2 IMS mechanisms according to rules and procedures of [3GPP TS 24.229] / [3GPP2 X.S0013.4] with the clarifications given in this subclause.

6.2.5 PoC Client receiving a Group Advertisement

Upon receiving a SIP MESSAGE request containing an Accept-Contact header including the PoC feature tag '+g.poc.groupad' the PoC Client:

- 1. MAY reject the SIP MESSAGE request with an appropriate reject code specified in [RFC3428] and [RFC3261] e.g.;
 - a) when the PoC Client determines that there is not enough resources to handle the SIP MESSAGE request; or,
 - b) any other reason outside the scope of this specification.

Otherwise, continue with the rest of the steps.

NOTE 1: The decision to reject the SIP MESSAGE request can e.g. be based on procedures between the PoC Client and the PoC User outside the scope of this specification.

NOTE 2: The case that PoC Client does not support the Group Advertisement is not needed to cover, because in this case the PoC Client has not registered the PoC feature tag '+g.poc.groupad' to the SIP/IP Core and will not receive a Group Advertisement message.

- 2. SHALL generate a 200 "OK" response according to rules and procedures of [RFC3428];
- 3. SHALL include the Server header to indicate the OMA PoC release version of the PoC Client as specified in subclause E.4.1 "*Release version in User-agent and Server headers*";
- 4. SHALL send the SIP 200 "OK" response towards the PoC Server according to rules and procedures of the SIP/IP Core.
- 5. SHOULD act based on the received Group Advertisement (e.g. by showing the advertisement to the PoC User);
- 6. SHOULD render the text content in Subject header to the PoC User if text is included in the Subject header and if Text Content is supported by the PoC Client; and,
- 7. SHOULD retrieve and render the referenced media content in the Call-Info header according to rules and procedures of [RFC 3261] if a reference is included in the Call-Info header, and if Referenced Media Content and referenced Media Type(s) are supported by the PoC Client.

NOTE 3: The PoC User can store information about the group received in the Group Advertisement locally in the PoC Client or in Shared List XDMS using procedures as specified in [XDM-Core] "*Procedures at the XDM Client*" and using the application usage as specified in [OMA-PoC-Document-Mgmt] "*Group Usage List*".

When the SIP/IP Core corresponds with 3GPP/3GPP2 IMS, the PoC Client SHALL use 3GPP/3GPP2 IMS mechanisms according to rules and procedures of [3GPP TS 24.229] / [3GPP2 X.S0013.4] with the clarifications given in this subclause.

6.2.6 PoC Client receiving a PoC Session SIP CANCEL request

6.2.6.1 PoC Session SIP CANCEL request - On-demand Session case

Upon receiving a SIP CANCEL request, the PoC Client SHALL behave as UAS according to rules and procedures of [RFC3261].

When the SIP/IP Core corresponds with 3GPP/3GPP2 IMS, the PoC Client SHALL use 3GPP/3GPP2 IMS mechanisms according to rules and procedures of [3GPP TS 24.229] / [3GPP2 X.S0013.4] with the clarifications given in this subclause.

6.2.7 Simultaneous PoC Session control procedures

PoC Client MAY use Simultaneous PoC Session control procedures if the PoC Server of the Home PoC Network supports Simultaneous PoC Sessions. The Invited PoC Client MAY change the PoC Session priority or PoC Session locking or both during a PoC Session as specified in subclauses 6.1.12.1 "*PoC Client Setting PoC Session Priority*" and 6.1.12.2 "*PoC Client handling of PoC Session locking*".

NOTE: The PoC Session locking is automatically released when the PoC Session is ended.

6.2.8 PoC Client receiving Discrete Media as a SIP MESSAGE

Upon receiving a SIP MESSAGE request not containing a MIME body of the MIME Type application/vnd.poc.fdcfo+xml either

- 1. outside the SIP dialog used for a PoC Session containing the PoC feature tag '+g.poc.discretemedias' in the Accept-Contact header field; or,
- 2. inside the SIP dialog used for the PoC Session;

the PoC Client:

- 1. SHALL perform the actions specified in [OMA_IM_TS_Endorsement] "*PoC Client receives SIP MESSAGE*".

NOTE: Responses for the SIP MESSAGE request are described in [OMA_IM_TS_Endorsement] "*PoC Client receives SIP MESSAGE*".

When the SIP/IP Core corresponds with 3GPP/3GPP2 IMS, the PoC Client SHALL use 3GPP/3GPP2 IMS mechanisms according to rules and procedures of [3GPP TS 24.229] / [3GPP2 X.S0013.4] with the clarifications given in this subclause.

6.2.9 PoC Client receiving an FDCFO Proceed SIP MESSAGE

Upon receiving a SIP MESSAGE request inside the SIP dialog used for the PoC Session with a MIME body of the MIME Type application/vnd.poc.fdcfo+xml, the PoC Client:

- 1. MAY reject the SIP MESSAGE request with an appropriate response code specified in [RFC3428] and [RFC3261]
 - a) when the PoC Client determines that there is not enough resources to handle the SIP MESSAGE request; or,
 - b) any other reason outside the scope of this specification.

NOTE 1: The decision to reject the SIP MESSAGE request can e.g. be based on procedures between the PoC Client and the PoC User outside the scope of this specification.

Otherwise continue with the rest of the steps;

- 2. SHALL generate a SIP 200 "OK" response according to rules and procedures of [RFC3428];

- 3. SHALL include the Server header to indicate the OMA PoC release version of the PoC Client as specified in subclause E.4.1 "*Release version in User-agent and Server headers*";
- 4. SHALL send the SIP 200 "OK" response towards the PoC Server according to rules and procedures of the SIP/IP Core; and,
- 5. SHOULD inform the PoC User of arrival of the FDCFO request;

If the PoC User accepts the switch to full duplex voice call, the PoC Client:

- a) SHOULD release the PoC Session as specified in subclause 6.1.6 "*PoC Client leaving a PoC Session*"; or,
- b) SHOULD remove the PoC Speech from the PoC Session as specified in subclause 6.1.4.6 "*Adding and disconnecting from Media*" if other Media Types than PoC Speech are used in the PoC Session.

NOTE 2: If PoC User accepts the switch to the full duplex voice call, the full duplex voice client collocated with the PoC Client initiates a full duplex call to one of the full duplex voice call addresses.

NOTE 3: The timing of the PoC Session release and the PoC Session modification is not specified in detail, the PoC Session release or the PoC Session modification can be postponed until after the full duplex voice client collocated with the PoC Client successfully establishes the full duplex voice call

When the SIP/IP Core corresponds with 3GPP/3GPP2 IMS, the PoC Client SHALL use 3GPP/3GPP2 IMS mechanisms according to rules and procedures of [TS24.229] / [3GPP2 X.S0013.4] with the clarifications given in this subclause.

6.2.10 PoC Client receiving capability query

NOTE 1: Only the terminating side capability query procedures are described since any entity can send the SIP OPTIONS request

Upon receiving a SIP OPTIONS request, the PoC Client:

- 1. SHALL handle the SIP OPTIONS request as an SIP INVITE request as specified in the subclause 6.2.1.2 "*Auto-answer case*" or in the subclause 6.2.1.3 "*Manual-answer case*" modified as follows:
 - a) any procedure checking the offered Media Types, offered the Media-floor Control Entities or the offered Media-floor Control Entity bindings are executed as if a MIME SDP body containing MBCP with bound PoC Speech was received;
 - b) the interactions with the User Plane are not performed;
 - c) the PoC User is not alerted and no information is rendered, indicated or displayed to the PoC User; and,
 - d) if generating the SIP 200 "OK" response, the PoC Client additionally:
 - i. SHOULD include in the SIP response an Allow header with the supported SIP methods according to rules and procedures of [RFC3261];
 - ii. SHOULD include in the SIP response an Accept header with the supported MIME body Media Types according to rules and procedures of [RFC3261];
 - iii. SHOULD include in the SIP response an Accept-Encoding header with the supported encoding formats according to rules and procedures of [RFC3261];
 - iv. SHOULD include in the SIP response a Supported header with an option tag 'timer' according to rules and procedures of [RFC3261];
 - v. SHALL either remove the Contact header from the SIP response or SHALL replace the Contact header value in the SIP response with the PoC Address of the PoC User according to rules and procedures of [RFC3261]; and,
 - vi. SHALL either remove the MIME SDP body from the SIP response or SHALL replace the MIME SDP body in the SIP response with a MIME SDP body containing the Media Types, the Media-floor Control Entities and the Media-floor Control Entity bindings supported by the PoC Client according to rules and procedures of [RFC3261].

NOTE 2: The MIME SDP body included in the SIP 200 "OK" response to the SIP OPTIONS request is not an SDP answer.

When the SIP/IP Core corresponds with 3GPP/3GPP2 IMS, the PoC Client SHALL use 3GPP/3GPP2 IMS Session establishment mechanisms according to rules and procedures of [3GPP TS 24.229] / [3GPP2 X.S0013.4] with the clarifications given in this subclause.

7. Procedures at the PoC Server

7.1 Determination of PoC Server role

This subclause describes how a PoC Server determines its role when receiving an initial or a stand-alone SIP request.

The behaviour in the PoC Server when receiving SIP requests within an existing SIP dialog is described under the respective PoC Server role.

Once the role is decided the role SHALL be kept until the SIP dialog is released, or until the stand-alone transaction is done.

7.1.1 Reception of an initial SIP INVITE request

Upon receiving an initial SIP INVITE request the PoC Server:

- 1. SHALL if it is the Originating PoC Service Point Trigger and
 - a) if the SIP URI in the Request-URI of the SIP INVITE request corresponds to the Conference-factory-URI of the PoC service in the network served by the PoC Server but the SIP INVITE request does not include a URI-list of the PoC Users to be invited the PoC Server SHALL perform the role of Participating PoC Function and continue as specified in subclause 7.3.1.2 "*Pre-established Session*"; or,
 - b) otherwise the PoC Server SHALL perform the role of the Participating PoC Function as specified in 7.3.1.4 "*PoC Session establishment or rejoin using On-demand Session*".
- 2. SHALL if it is the Terminating PoC Service Point Trigger and
 - a) if the SIP URI in the Request-URI of the SIP INVITE request corresponds to a PoC Group owned by the PoC Server or if the SIP URI in the Request-URI of the SIP INVITE request corresponds to a PoC Session Identity generated by the PoC Server, the PoC Server SHALL continue as specified in subclause 7.2.1.1b "*PoC Session setup request*"; or,
 - b) if the SIP-URI in the Request-URI of the SIP INVITE request corresponds to a PoC User served by the PoC Server the PoC Server SHALL perform the role of Participating PoC Function and continue as specified in subclause 7.3.2.2 "*PoC Session invitation request*"; or,
 - c) if the SIP URI in the Request-URI of the SIP INVITE request is unknown to the PoC Server the PoC Server SHALL perform the actions specified in subclause 7.5.2 "*Conference URI does not exist*".
- 3. SHALL if it is the unregistered PoC Service Point Trigger and
 - a) if the PoC Server supports PoC Box functionality and the "allow" attribute of the <allow-offline-storage> element as specified in [OMA-PoC-Document-Mgmt] is set to 'true' the PoC Server SHALL determine whether to route the SIP INVITE request to a PoC Box as specified in subclause 7.3.2.2.5.1 "*Determination of routing to a PoC Box upon an incoming invitation*" and if it was determined to route the invitation to a NW PoC Box the PoC Server SHALL route the request to a NW PoC Box as specified in subclause 7.3.2.2.5.3 "*Forward invitations to a NW PoC Box*" and not continue with the rest of the steps;.
 - b) Otherwise the PoC Server SHALL respond with a SIP 480 "Temporarily Unavailable" response.

7.1.2 Reception of a SIP REFER request

Upon receiving a SIP REFER request outside of an existing SIP dialog the PoC Server

- 1. SHALL if it is the Originating PoC Service Point Trigger continue as specified in subclause 7.3.1.8 "*SIP REFER request received*"; or,
- 2. SHALL if it is the Terminating PoC Service Point Trigger and
 - a) if the SIP REFER request is received with a Refer-To header without a method parameter in the Refer-To URI or when the method parameter is set to "INVITE" in the Refer-To URI, then:
 - i. if the Refer-To URI includes an Accept-Contact header with the PoC Dispatcher feature tag '+g.poc.dispatcher' along with 'require' and 'explicit' parameters, continue as specified in subclause 7.2.1.24 "*PoC Dispatcher role transfer request*".

- ii. otherwise, continue as specified in subclause 7.2.1.8 "*Adding Participants to PoC Session request*";
- or
- b) if the method parameter is set to "BYE" in the Refer-To header
 - i. continue as specified in subclause 7.2.1.9.2 "*SIP REFER BYE request received when using a Pre-established Session*" in case of a Pre-established Session; or,
 - ii. continue as specified in subclause 7.2.1.9.4 "*SIP REFER BYE request received when using an On-demand Session*" in case of an On-demand Session.

7.1.3 Reception of a SIP MESSAGE request

Upon receiving a SIP MESSAGE request containing the PoC feature tag '+g.poc.talkburst' in the Accept-Contact header the PoC Server:

- 1. SHALL if it is the Originating PoC Service Point Trigger continue as specified in subclause 7.4.1.1 "*Instant Personal Alert procedure at originating PoC Server*"; or,
- 2. SHALL if it is the Terminating PoC Service Point Trigger continue as specified in subclause 7.4.1.2 "*Instant Personal Alert procedure at terminating PoC Server*".

Upon receiving a SIP MESSAGE request containing the PoC feature tag '+g.poc.discretedia' in the Accept-Contact header the PoC Server:

- 1. SHALL if it is the Originating PoC Service Point Trigger continue as specified in subclause 7.3.1.16 "*Discrete Media request*"; or,
- 2. SHALL if the Terminating PoC Service Point Trigger and the Request-URI contains a SIP URI corresponding to a PoC Group or PoC Session Identity known by the PoC Server, continue as specified in the subclause 7.2.1.23 "*Discrete Media request*"; or,
- 3. SHALL if it is the Terminating PoC Service Point Trigger and the Request-URI contains a SIP-URI corresponding to a PoC User served by the PoC Server continue as specified in subclause 7.3.2.8 "*Discrete Media request*".

Upon receiving a SIP MESSAGE request containing the PoC feature tag '+g.poc.fdcfo' in the Accept-Contact header the PoC Server:

- 1. SHALL if it is the Originating PoC Service Point Trigger continue as specified in subclause 7.3.1.17 "*FDCFO Proceed request*"; or,
- 2. SHALL if the Terminating PoC Service Point Trigger and the Request-URI contains a SIP URI corresponding to a PoC Session Identity known by the PoC Server, continue as specified in the subclause 7.2.1.25 "*FDCFO Proceed request*"; or,
- 3. SHALL if it is the Terminating PoC Service Point Trigger and the Request-URI contains a SIP-URI corresponding to a PoC User served by the PoC Server continue as specified in subclause 7.3.2.9 "*FDCFO Proceed request*".

Upon receiving a SIP MESSAGE request containing the PoC feature tag '+g.poc.groupad' in the Accept-Contact header the PoC Server:

- 1. SHALL if it is the Originating PoC Service Point Trigger continue as specified in subclause 7.3.1.11 "*Group Advertisement request*"; or,
- 2. SHALL if the Terminating PoC Service Point Trigger and the Request-URI contains a SIP URI corresponding to a PoC Group known by the PoC Server, continue as specified in the subclause 7.2.1.12 "*Group Advertisement request*"; or,
- 3. SHALL if it is the Terminating PoC Service Point Trigger and the Request-URI contains a SIP-URI corresponding to a PoC User served by the PoC Server continue as specified in subclause 7.3.2.7 "*Group Advertisement request*".

7.1.4 Reception of a SIP SUBSCRIBE request

Upon receiving a SIP SUBSCRIBE request outside of an existing SIP dialog the PoC Server:

- 1. SHALL if it is the Originating PoC Service Point Trigger continue as specified in 7.3.1.7 "*SIP SUBSCRIBE request*"; or,
- 2. SHALL if it is the Terminating PoC Service Point Trigger continue as specified in subclause 7.2.1.11 "*PoC Session Participant information Request*".

7.1.5 Reception of a SIP OPTIONS request

Upon receiving a SIP OPTIONS request containing the PoC feature tag '+g.poc.talkburst' in the Accept-Contact header the PoC Server:

- 1. SHALL if it is the Originating PoC Service Point Trigger continue as specified in the subclause 7.3.1.18 "*Querying for capabilities*"; or,
- 2. SHALL if the Terminating PoC Service Point Trigger and the Request-URI contains a SIP URI corresponding to a PoC Group or PoC Session Identity known by the PoC Server, continue as specified in the subclause 7.2.1.26 "*Querying for capabilities*"; or,
- 3. SHALL if it is the Terminating PoC Service Point Trigger and the Request-URI contains a SIP-URI corresponding to a PoC User served by the PoC Server continue as specified in the subclause 7.3.2.11 "*Querying for capabilities*".

7.1.6 Reception of a SIP REGISTER request

Upon receiving a SIP REGISTER request the PoC Server:

- 1. SHALL continue as specified in the subclause 7.4.2.1 "*Reception of the SIP REGISTER request*".

7.2 Controlling PoC Function procedures

7.2.1 Request terminating at the Controlling PoC Function

7.2.1.1 General

NOTE 1: This subclause provides common procedures for other subclauses and is not meant to be applied unless referenced.

On receipt of an initial SIP INVITE request the PoC Server

- 1. SHALL cache the supported SIP methods if received in the Allow header;
- 2. SHALL cache SIP feature tags, if received in the Contact header, and if the specific feature tags are supported;
- 3. SHALL create and cache the Nick Name as specified in subclause 5.4 "*Nick Name*"; and,
- 4. SHALL cache the uri-parameter "b2bua", if the uri-parameter is present in the URI of the PoC Server performing Participating PoC Function in the Contact header and if the uri parameter is used according to local policy.

When sending SIP provisional responses with the exception of the SIP 100 "Trying" response to the SIP INVITE request the PoC Server

- 1. SHALL generate the SIP provisional response according to rules and procedures of [RFC3261];
- 2. SHALL include the Server header with the OMA PoC release version of the PoC Server as specified in subclause E.4.1 "*Release version in User-agent and Server headers*";
- 3. SHOULD include an Allow header with the SIP methods supported in this SIP dialog according to rules and procedures of [RFC3261];
- 4. SHALL include Authenticated Originator's PoC Address as specified in subclause 5.2 "*Authenticated Originator's PoC Address*"
 - a) set to the Conference-factory-URI in case of 1-1 PoC Session or Ad-hoc PoC Group Session; or,
 - b) set to the PoC Group Identity with the Session Type uri-parameter "session=prearranged" or "session=chat" as specified in E.5.1 "*Session Type uri-parameter*" in case of Pre-arranged or Chat PoC Group respectively.

- 5. SHALL include in a Contact header the PoC Session Identity with the feature tag 'isfocus' and the PoC feature tag '+g.poc.talkburst' and the Session Type uri-parameter "session=1-1", or "session=adhoc", or "session=prearranged", or "session=chat" as appropriate for the type of the PoC Session as specified in E.5.1 "*Session Type uri-parameter*".
- 6. SHALL copy into the Contact header the feature tags 'sip.automata', 'sip.actor' and 'sip.description' with their corresponding value if any of these are included in the Contact header of the incoming received SIP response;

NOTE 2: If both UE PoC Box and NW PoC Box take part in the PoC Session and a provisional response other than SIP 100 "Trying" was already sent, the feature tag 'sip.actor' has the same value as in the previous provisional response. If both UE PoC Box and NW PoC Box take part in the PoC Session and no provisional response other than SIP 100 "Trying" has been sent yet, the feature tag 'sip.actor' value is either 'principal' or 'msg-taker' according to the PoC Server local policy.

- 7. SHALL include the warning text set to '108 media content in INVITE discarded' as specified in subclause 5.6 "*Warning header*", if at least one MIME body with media content was removed as specified in subclauses 7.2.1.2 "*Ad-hoc PoC Group and 1-1 PoC Session setup request*" and 7.2.1.3 "*Pre-arranged PoC Group Session setup request*";
- 8. SHALL include the warning text set to '108 media content in INVITE discarded' as specified in subclause 5.6 "*Warning header*", if the text content in the Subject header was removed;
- 9. SHALL include the warning text set to '108 media content in INVITE discarded' as specified in subclause 5.6 "*Warning header*", if the Alert-Info header or the Call-Info header or both was removed; and,

NOTE 3: The reason for removing the Subject header and the reason for removing the Alert-Info header or the Call-Info header or both may be a local policy in the PoC Server.

- 10. SHALL include Warning header(s) received in incoming provisional responses to SIP INVITE request with the exception of the SIP 100 "Trying" response.

When sending a SIP 200 "OK" response to the initial SIP INVITE request the PoC Server:

- 1. SHALL generate the SIP 200 "OK" response according to rules and procedures of [RFC3261];
- 2. SHOULD include an Allow header with the SIP methods supported in this SIP dialog according to rules and procedures of [RFC3261];
- 3. SHALL include the Session-Expires header with and start supervising the SIP Session according to rules and procedures of [RFC4028], "*UAS Behavior*". The "refresher" parameter in the Session-Expires header SHALL be set to 'uac';
- 4. SHALL include the option tag 'timer' in a Require header;
- 5. SHALL include Authenticated Originator's PoC Address as specified in subclause 5.2 "*Authenticated Originator's PoC Address*"
 - a) set to the Conference-factory-URI in case of 1-1 PoC Session or Ad-hoc PoC Group Session; or,
 - b) set to the PoC Group Identity with the Session Type uri-parameter "session=prearranged" or "session=chat" as specified in E.5.1 "*Session Type uri-parameter*" in case of the Pre-arranged or Chat PoC Group respectively.
- 6. SHALL include in a Contact header the PoC Session Identity with the feature tag 'isfocus' and the PoC feature tag '+g.poc.talkburst' and the Session Type uri-parameter "session=1-1", or "session=adhoc", or "session=prearranged", or "session=chat" as appropriate for the type of the PoC Session as specified in E.5.1 "*Session Type uri-parameter*";
- 7. SHALL copy into the Contact header the feature tags, 'sip.automata', 'sip.actor' and 'sip.description' with their corresponding value if any of these are included in the Contact header of the incoming received SIP response;

NOTE 4: If both UE PoC Box and NW PoC Box take part in the PoC Session and a provisional response other than SIP 100 "Trying" was already sent, the feature tags 'sip.actor' and 'sip.description' have the same value as in the previous provisional response. If both UE PoC Box and NW PoC Box take part in the PoC Session and no provisional response other than SIP 100 "Trying" has been sent yet, the feature tag 'sip.actor' value is either 'principal' or 'msg-taker' according to the PoC Server local policy.

- 8. SHALL include the Server header with the OMA PoC release version of the PoC Server as specified in subclause E.4.1 "*Release version in User-agent and Server headers*" if not already included in a SIP provisional response;

- 9. SHALL include the warning text set to '108 media content in INVITE discarded' as specified in subclause 5.6 "Warning header", if at least one MIME body with media content was removed as specified in subclauses 7.2.1.2 "Ad-hoc PoC Group and 1-1 PoC Session setup request" and 7.2.1.3 "Pre-arranged PoC Group Session setup request";
- 10. SHALL include the warning text set to '108 media content in INVITE discarded' as specified in subclause 5.6 "Warning header", if the text content in the Subject header was removed as specified in subclauses 7.2.1.2 "Ad-hoc PoC Group and 1-1 PoC Session setup request" and 7.2.1.3 "Pre-arranged PoC Group Session setup request";
- 11. SHALL include the warning text set to '108 media content in INVITE discarded' as specified in subclause 5.6 "Warning header", if the Alert-Info header or the Call-Info header or both was removed as specified in subclauses 7.2.1.2 "Ad-hoc PoC Group and 1-1 PoC Session setup request" and 7.2.1.3 "Pre-arranged PoC Group Session setup request";
- 12. SHALL include Warning header(s) received in incoming responses to SIP INVITE request; and,
- 13. SHALL include the option tag 'norefersub' in a Supported header according to rules and procedures of [RFC4488].

When sending a SIP 488 "Not Acceptable Here" response to the initial SIP INVITE request, the PoC Server:

- 1. SHALL generate the SIP 488 "Not Acceptable Here" response according to rules and procedures of [RFC3261]; and,
- 2. SHALL perform one of the following actions:
 - a) include in the SIP 488 "Not Acceptable Here" response a MIME SDP body, containing the Media Types, the Media-floor Control Entities and the Media-floor Control Entity bindings as currently used in the PoC Session according to rules and procedures of [RFC3261], if the offered Media Types were none of those currently used in the PoC Session; or,
 - b) include the warning text set to '107 Not authorized to add <Media Type>' as specified in subclause 5.6 "Warning header", if the offered Media Type is not authorized for the PoC User.

When the SIP/IP Core corresponds with 3GPP/3GPP2 IMS, the PoC Server SHALL use 3GPP/3GPP2 IMS Session establishment mechanisms according to rules and procedures of [3GPP TS 24.229] / [3GPP2 X.S0013.4] with the clarifications given in this subclause.

7.2.1.1a SDP answer generation

When receiving an SDP offer to initiate a 1-1 PoC Session, an Ad-hoc PoC Group Session or Pre-arranged PoC Group Session and if the PoC Session does not yet exist, then the PoC Server:

- 1. SHALL accept all the Media with bound Media-floor Control Entities and the Media not bound to Media-floor Control Entity from the received SDP offer, which are allowed by adding Media policy as specified in subclause 7.2.1.21 "Policy for allowing Media Streams in a PoC Session", when Unconfirmed Indication is used;
- 2. SHALL accept all the Media with bound Media-floor Control Entities and the Media not bound to Media-floor Control Entity from the received SDP offer, which are allowed by adding Media policy as specified in subclause 7.2.1.21 "Policy for allowing Media Streams in a PoC Session", when the PoC Server has received the SDP answer(s) from one or more, but not from all the Invited PoC Clients; or,

NOTE 1: The conditions for the removal of the Media Type offered by the Inviting PoC Client, accepted by the PoC Server and not accepted by any Invited PoC Client is out of scope of this specification.

- 3. SHALL accept all the Media with bound Media-floor Control Entities and the Media not bound to a Media-floor Control Entities from the received SDP offer which are also accepted in at least one of the received SDP answers from the Invited PoC Clients.

NOTE 2: The PoC Server as a matter of local policy can wait for a number of answers, for amount of time or for other reasons before sending the SDP answer.

NOTE 3: In step 3, the adding Media policy is not needed to be checked anymore as it has been already checked when the SDP offers have been sent towards the terminating PoC Clients.

When receiving an SDP offer to initiate a Pre-arranged PoC Group Session that already exists or when receiving an SDP offer to re-join a PoC Session, the PoC Server:

- 1. SHALL accept all the Media Streams with bound Media-Floor Control Entities in the received SDP offer that are currently used in the PoC Session and that are bound to the same Media-Floor Control Entity; and,
- 2. SHALL accept all Discrete Media Streams not bound to a Media-Floor Control Entity in the received SDP offer and which are currently used in the PoC Session without Media-Floor Control Entity binding.

When receiving an SDP offer to initiate or join a Chat PoC Group Session, the PoC Server:

- 1. SHALL accept all the Media Types with bound Media-Floor Control Entities in the received SDP offer which are currently used in the PoC Session, if the PoC Session already exists, or which are allowed by adding Media policy as specified in subclause 7.2.1.21 "*Policy for allowing Media Streams in a PoC Session*"; and,
- 2. SHALL accept the Discrete Media without bound Media-Floor Control Entity in the received SDP offer which are currently used in the PoC Session, if the PoC Session already exists, or which are allowed by adding Media policy as specified in subclause 7.2.1.21 "*Policy for allowing Media Streams in a PoC Session*".

When composing an SDP answer according to rules and procedures of [RFC3264] and [RFC4566] the PoC Server:

- 1. SHALL set the IP address of the PoC Server for each accepted Media Stream from the received SDP offer and for each accepted Media-floor Control Entity from the received SDP offer;
- 2. SHALL include the media-level section for each accepted Media Stream from the received SDP offer consisting of:
 - a) the port number for the Media Stream selected as specified in [OMA-PoC-UP] "*Port numbers*";
 - b) the codec(s) and Media Parameters selected by the PoC Server from the list contained in the received SDP offer; optionally further reduced based on:
 - i. the SDP answer(s) received in SIP 200 "OK" response(s) from the Invited PoC Client(s), if already received;
 - ii. the SDP answer(s) received in SIP 200 "OK" response(s) from the Participant(s) other than Invited PoC Client(s), if already received;
 - iii. the SDP answer(s) sent in SIP 200 "OK" response(s) to the Participant(s), if sent previously; and,
 - iv. the Media Parameters that are currently used in this PoC Session, if PoC Session has already been set up.

NOTE 4: The Media Parameters of the Discrete Media are defined in [OMA_IM_TS_Endorsement].

NOTE 5: If transcoding is supported and codec(s) and Media Parameters other than those contained in the received SDP offer have been offered in the SDP of the SIP INVITE request sent to Invited PoC Client(s), the SDP answer in the SIP 200 "OK" response towards the Inviting PoC Client can be different from the SDP answer received in SIP 200 "OK" response from the Invited PoC Client(s).

- c) the "a=label" attribute with a unique value as specified in [RFC4574], if the Media Stream is to be connected to a Media-floor Control Entity except when only PoC Speech with Talk Burst Control Protocol as specified in [OMA-POC-1-UP] is accepted;
- d) the IP address of the PoC Server and port number to be used for RTCP selected as specified in [OMA-PoC-UP] "*Port numbers*", according to rules and procedures of [RFC3605], if the Media Stream uses the RTCP protocol and other than the default IP address or port number specified by the [RFC3550] is to be used;
- e) the "a=upcc:0" attribute as specified in [RFC3108], if the PoC Server supports the PoC Media Traffic Optimisation, the Participant did not put the PoC Session on hold, the media-level section offers a Continuous Media and the 1-many-1 communication method is not used in the PoC Session; and,
- f) under the media level definition of MSRP, add to "a=accept-types:" SDP attribute MIME Types "application/vnd.oma.poc.final-report+xml", "application/vnd.oma.poc.detailed-progress-report+xml" and optionally "application/vnd.oma.poc.optimized-progress-report+xml" if any of these were included in the received SDP offer and if supported by the PoC Server.
- 3. SHALL include for any Media-floor Control Entity, that is offered in the received SDP offer and accepted in the SDP answer by the PoC Server, the media-level section of each offered Media-floor Control Entity consisting of:

- a) the format list field for the Media-floor Control Entity is set to "TBCP";
- b) the Media-floor Control Entity parameters selected by the PoC Server from the list contained in the received SDP offer; optionally reduced based on the SDP answer(s) received in SIP 200 "OK" response from the Invited PoC Client(s), if already received;

NOTE 6: The PoC Server can reduce Media-floor Control Entity parameters depending on answers received from Invited PoC Clients, e.g. if the SDP offer in SIP INVITE request from the Inviting PoC Client contained a request to use queuing in the PoC Session and a received SDP answer from an Invited PoC Client did not indicate support for queuing the PoC Server can return to the Inviting PoC Client that queuing is not used in this PoC Session.

- c) the port number for Media-floor Control Entity selected as specified in [OMA-PoC-UP] "*Port numbers*";
 - d) the "a=floorid:0 mstrm" attribute with value(s) referencing the Media Stream as specified in [RFC4583] intended to be connected the Media-floor Control Entity except when only PoC Speech with Talk Burst Control Protocol as specified in [OMA-POC-1-UP] is accepted; and,
 - e) optionally TBCP MIME parameters indication as specified in E.3 "*SDP Extensions*" including if needed the TBCP MIME parameter "multimedia" with the appropriated value as specified in E.3 "*SDP Extensions*";
- 4. SHALL mark as rejected according to rules and procedures of [RFC3264] the Media-floor Control Entity and all the Media Stream bound to the rejected Media-floor Control Entity, if the Media-floor Control Entity is rejected;
 - 5. SHALL mark the Media Stream as rejected according to rules and procedures of [RFC3264], if the Media Stream is rejected; and,
 - 6. SHALL include the QoE Profile assigned for the PoC Session, as specified in subclause E.3.2 "*QoE Profile*", if QoE Profiles are enabled and if a QoE Profile was included in the received SDP offer.

When composing an SDP answer, the PoC Server:

- 1. SHALL bind the media-level section that identifies PoC Speech to the corresponding Media-floor Control Entity as in the received SDP offer, if PoC Speech is accepted;
- 2. SHALL bind the media-level section that identifies Video to the corresponding Media-floor Control Entity as in the received SDP offer, if Video is accepted;
- 3. SHALL bind the media-level section that identifies Audio to the corresponding Media-floor Control Entity as in the received SDP offer, if Audio is accepted; and,
- 4. SHALL bind the media-level section that identifies Discrete Media to the corresponding Media-floor Control Entity as in the received SDP offer, if Discrete Media is accepted and bound to the Media-floor Control Entity.

When the SIP/IP Core corresponds with 3GPP/3GPP2 IMS, the PoC Server SHALL use 3GPP/3GPP2 IMS Session establishment mechanisms according to rules and procedures of [3GPP TS 24.229] / [3GPP2 X.S0013.4] with the clarifications given in this subclause.

7.2.1.1b PoC Session setup request

Upon receiving an initial SIP INVITE request with the SIP URI in the Request-URI corresponding to a PoC Group owned by the PoC Server or corresponding to a PoC Session Identity generated by the PoC Server and:

- 1. if the Session Type uri-parameter is "session=prearranged" and,
 - a) if the SIP URI in the Request-URI of the SIP INVITE request corresponds to a Pre-arranged PoC Group owned by the PoC Server, the PoC Server SHALL perform the role of Controlling PoC Function and continue as specified in subclause 7.2.1.3 "*Pre-arranged PoC Group Session setup request*";
 - or,
 - b) if the SIP URI in the Request-URI of the SIP INVITE request corresponds to a Chat PoC Group owned by the PoC Server, the PoC Server SHALL return a SIP 404 "Not Found" response with the warning text set to '100 Correct Session Type of <Request-URI> is "session=chat"' as specified in subclause 5.6 "*Warning header*". Otherwise continue with the rest of the steps.
 - or,
- 2. if the Session type uri-parameter is "session=chat" and,

- a) if the Accept-Contact header contains the feature tag 'automata' and the feature tag 'actor' with the value of 'msg-taker' or 'principal' and the parameters 'explicit' and 'require' the PoC Server SHALL return a SIP 404 "Not Found" response with the warning text set to '109 PoC Box not possible for a Chat PoC Group' as specified in subclause 5.6 "Warning header". Otherwise continue with next step;
- b) if the SIP URI in the Request-URI of the SIP INVITE request corresponds to a Chat PoC Group owned by the PoC Server, the PoC Server SHALL perform the role of Controlling PoC Function and continue as specified in subclause 7.2.1.5 "Joining Chat PoC Group Session request".
- or,
- c) if the SIP URI in the Request-URI of the SIP INVITE request corresponds to a Pre-arranged PoC Group owned by the PoC Server, the PoC Server SHALL return a SIP 404 "Not Found" response with the warning text set to '101 Correct Session Type of <Request-URI> is "session=prearranged"' as specified in subclause 5.6 "Warning header". Otherwise continue with the rest of the steps.
- or,
- 3. if the Session Type uri-parameter is "session=1-1" or "session=adhoc" and,
 - a) if the SIP URI in the Request-URI of the SIP INVITE request corresponds to a Pre-arranged PoC Group owned by the PoC Server, the PoC Server SHALL return a SIP 404 "Not Found" response with the warning text set to '101 Correct Session Type of <Request-URI> is "session=prearranged"' as specified in subclause 5.6 "Warning header". Otherwise continue with the rest of the steps.
 - b) if the SIP URI in the Request-URI of the SIP INVITE request corresponds to a Chat PoC Group owned by the PoC Server, the PoC Server SHALL return a SIP 404 "Not Found" response with the warning text set to '100 Correct Session Type of <Request-URI> is "session=chat"' as specified in subclause 5.6 "Warning header". Otherwise continue with the rest of the steps.
 - or,
- 4. if a Session Type uri parameter is not included and
 - a) if the SIP URI in the Request-URI of the SIP INVITE request corresponds to a Pre-arranged PoC Group owned by the PoC Server, the PoC Server SHALL perform the role of Controlling PoC Function and continue as specified in subclause 7.2.1.3 "Pre-arranged PoC Group Session setup request";
 - or,
 - b) if the SIP URI in the Request-URI of the SIP INVITE request corresponds to a Chat PoC Group owned by the PoC Server and the Accept-Contact header contains the feature tag 'automata' with the parameters 'explicit' and 'require' the PoC Server SHALL return a SIP 404 "Not Found" response with the warning text set to '109 PoC Box not possible for a Chat PoC Group' as specified in subclause 5.6 "Warning header"; Otherwise continue with the rest of the steps;
 - or,
 - c) if the SIP URI in the Request-URI of the SIP INVITE request corresponds to a Chat PoC Group owned by the PoC Server and the Accept-Contact header does not contain the feature tag 'automata' and the feature tag 'actor' with the value of 'msg-taker' or 'principal' and the parameters 'explicit' and 'require', the PoC Server SHALL perform the role of Controlling PoC Function and continue as specified in subclause 7.2.1.5 "Joining Chat PoC Group Session request";
- 5. if the SIP-URI in the Request-URI of the SIP INVITE request corresponds to a PoC Session Identity generated by the PoC Server, the PoC Server SHALL perform the role of Controlling PoC Function and continue as specified in subclause 7.2.1.4 "Rejoining PoC Session request".

7.2.1.2 Ad-hoc PoC Group and 1-1 PoC Session setup request

Upon receiving of an initial SIP INVITE request the PoC Server:

- 1. MAY reject the SIP INVITE request with a SIP 503 "Service Unavailable" response depending on the value of the requested QoE Profile if QoE Profiles are enabled and a risk of congestion exists as specified in [OMA-PoC-UP] "Procedures at the PoC Server performing the Controlling PoC Function". The PoC Server MAY include a Retry-After header to the 503 "Service Unavailable" response as specified in [RFC3261];

NOTE 1: The PoC Client is allowed to re-attempt the PoC Session establishment after the time defined by the Retry-After header.

- 2. SHALL check whether the Conference-factory-URI contained in the Request URI is allocated and perform the actions specified in subclause 7.5.1 "*Conference-factory URI does not exist*" if it is not allocated. Otherwise, continue with the rest of the steps;
- 3. SHALL perform actions to verify the Authenticated Originator's PoC Address of the Inviting PoC User and authorize the request according to local policy, and if it is not authorized the PoC Server SHALL return a SIP 403 "Forbidden" response with the warning text set to '121 Function not allowed due to <detailed reason>' as specified in subclause 5.6 "*Warning header*". Otherwise, continue with the rest of the steps;
- 4. SHALL validate that the received SDP offer includes at least one Media Stream for which the Media Parameters and at least one codec or Media format is acceptable by the PoC Server and if not reject the request with a SIP 488 "Not Acceptable Here" response generated as specified in the subclause 7.2.1.1 "*General*". Otherwise, continue with the rest of the steps;
- 5. SHALL check from the MIME resource-lists body that the maximum number of Participants allowed in an Ad-hoc PoC Group Session is not exceeded. If exceeded, PoC Server SHALL return SIP 486 "Busy Here" response and include the warning text set to '102 Too many participants' as specified in subclause 5.6 "*Warning header*". Otherwise, continue with the rest of the steps;

NOTE 2: With regards to "MAX-ADHOC-GROUP-SIZE" parameter, the initiator of the PoC Session is also counted as a Participant.

- 6. SHALL perform the following actions, if Included Media Content is supported by the PoC Server and if the media content is received in one or more MIME bodies:
 - a) Check if included Media Type is allowed, using a local policy, and if at least one Media Type is not allowed, based on a Service Provider Policy either,
 - i. send a SIP 415 "Unsupported Media Type" response, the SIP 415 "Unsupported Media Type" response SHALL include:
 - 1. the Accept header with the acceptable Media-Types that the PoC Server would accept according to rules and procedures of [RFC3261]; or,
 - 2. the Accept-Encoding header with the encoding formats that the PoC Server would accept according to rules and procedures of [RFC3261]; or,
 - 3. both.
 - and do not continue with the rest of the steps; or,
 - ii. remove the MIME bodies containing the not allowed media content.

NOTE 3: One example of a local policy could be that the PoC Server only allows Included Media Content in special traffic scenarios.

- b) Check the total size of all MIME bodies containing media content and if the total size exceeds a configurable max size, based on a Service Provider policy either,
 - i. send a SIP 413 "Request Entity Too Large" response and do not continue with the rest of the steps; or,
 - ii. remove all MIME bodies containing media content.
- 7. SHALL check if a Resource-Priority header is included in the SIP INVITE request according to rules and procedures of [RFC4412], if the 'Official Government Use' QoE Profile is supported. If included the PoC Server SHALL:
 - a) check that the QoE Profile attribute contained in the SDP offer indicates 'Official Government Use' QoE Profile, as specified in subclause E.3.2 "*QoE Profile*". If the QoE Profile attribute indicates other QoE Profile, the PoC Server SHALL reject the request with a SIP 403 "Forbidden" response with the warning text set to '114 QoE Assignment Error' as specified in subclause 5.6 "*Warning header*";
 - b) assign 'Official Government Use' QoE Profile as the QoE Profile for the PoC Session; and,
 - c) apply any preferential treatment to the SIP request as specified in [RFC4412], skip the next step and proceed with the rest of the steps.
- 8. SHALL assign the QoE Profile to the PoC Session according to the value indicated in the QoE Profile attribute included in the received SDP offer, as specified in subclause E.3.2 "*QoE Profile*" if QoE Profiles are enabled;

NOTE 4: If no QoE Profile attribute is included in the SDP offer of the SIP INVITE request, it is considered that 'Basic' QoE Profile is requested.

- 9. SHOULD check whether the "b=AS" attribute is included in the SDP offer, and if it is, use the attribute as specified in [OMA-PoC-UP] "*Media Buffering*";
- 10. MAY remove the Subject header;
- 11. MAY remove the Alert-Info or the Call-Info header or both;

NOTE 5: The reason for removing the Alert-Info header or the Call-Info header or both may be a local policy in the PoC Server.

- 12. SHALL allocate a PoC Session Identity for the PoC Session; and,
- 13. SHALL invite the PoC Users and Pre-arranged PoC Groups listed in the MIME resource-lists body as specified in subclause 7.2.2.2 "*PoC Session invitation request*".

NOTE 6: How the multiple URIs of the invited members are conveyed in the SIP INVITE request is specified in [draft-URI-list]. How each URI in the list is anonymized is specified in [draft-URI-list-capacity].

Upon receiving a SIP 183 "Session Progress" response for the SIP INVITE request containing a P-Answer-State header with the value "Unconfirmed" as specified in [RFC4964] and as specified in subclause 7.2.2.2 "*PoC Session invitation request*" the PoC Server:

- 1. SHALL generate 200 "OK" response as specified in the subclause 7.2.1.1 "*General*" and continue with the rest of the steps if unconfirmed mode is supported by the PoC Server and the final response is not yet sent to the Inviting PoC Client, otherwise do not proceed with the rest of the steps;
- 2. SHALL include in the SIP 200 "OK" response a MIME SDP body as an SDP answer to the SDP offer in the incoming SIP INVITE request as specified in the subclause 7.2.1.1a "*SDP answer generation*";
- 3. SHALL include a P-Answer-State header with the value "Unconfirmed";
- 4. SHALL interact with the User Plane as specified in [OMA-PoC-UP] "*Controlling PoC Function procedures at PoC Session initialization*";

NOTE 7: Resulting User Plane processing is completed before the next step is performed.

- 5. SHALL send the SIP 200 "OK" response towards the Inviting PoC Client according to rules and procedures of SIP/IP Core;

NOTE 8: If PoC Server supports Unconfirmed Indication and generates and sends SIP 200 "OK" response towards Inviting PoC Client based on received SIP 183 "Session Progress", then PoC Server needs either to prepare for transcoding or PoC Session modification. This is needed in the case if the SDP answer contained in SIP 200 "OK" sent towards Inviting PoC Client is in mismatch with the SDP answer contained in SIP 200 "OK" received from the terminating network.

- 6. SHALL generate a notification to the PoC Clients, which have subscribed to the conference state event package that an Inviting PoC User has joined in the PoC Group Session, as specified in subclause 7.2.1.11.2 "*Generating a SIP NOTIFY request*"; and,
- 7. SHALL send the SIP NOTIFY request to the PoC Clients according to rules and procedures of the SIP/IP Core.

Upon receiving a SIP 180 "Ringing" response as specified in subclause 7.2.2.2 "*PoC Session Invitation Request*" and the SIP final response or a SIP 180 "Ringing" response has not yet been sent to the Inviting PoC Client, the PoC Server:

- 1. SHALL generate a SIP 180 "Ringing" response to the SIP INVITE request as specified in the subclause 7.2.1.1 "*General*"; and,
- 2. SHALL send the SIP 180 "Ringing" response towards the Inviting PoC Client according to rules and procedures of SIP/IP Core.

Upon receiving a SIP 200 "OK" response for the SIP INVITE request as specified in subclause 7.2.2.2 "*PoC Session invitation request*" and if the SIP final response has not yet been sent to the Inviting PoC Client the PoC Server:

- 1. SHALL generate a SIP 200 "OK" response to the SIP INVITE request as specified in the subclause 7.2.1.1 "General" before continuing with the rest of the steps;
- 2. SHALL include in the SIP 200 "OK" response a MIME SDP body as an SDP answer to the SDP offer in the incoming SIP INVITE request as specified in the subclause 7.2.1.1a "SDP answer generation";
- 3. SHALL interact with the User Plane as specified in [OMA-PoC-UP] "Controlling PoC Function procedures at PoC Session initialization";

NOTE 9: Resulting User Plane processing is completed before the next step is performed.

- 4. SHALL send a SIP 200 "OK" response towards the Inviting PoC Client according to rules and procedures of the SIP/IP Core;
- 5. SHALL generate a notification to the PoC Clients, which have subscribed to the conference state event package that an Inviting PoC User has joined in the PoC Group Session, as specified in subclause 7.2.1.11.2 "Generating a SIP NOTIFY request"; and,
- 6. SHALL send the SIP NOTIFY request to the PoC Clients according to rules and procedures of the SIP/IP Core.

Upon receiving a SIP final response other than 2xx or 3xx, that is one of the SIP 4xx, 5xx or 6xx final responses the PoC Server:

- 1. SHALL send the SIP final response towards the Inviting PoC Client, if a SIP final response was received from all the Invited PoC Clients and the SIP 200 "OK" response is not yet sent. The SIP final response SHALL include the Status-Code defined by the PoC Server according to local policy e.g. the lowest value received from the Invited PoC User(s); or,
- 2. SHALL remove Inviting PoC Client from the PoC Session as specified in subclause 7.2.2.4 "Remove of Participant from PoC Session", if a SIP final response other than 2xx or 3xx was received from all the Invited PoC Clients and the SIP 200 "OK" response is already sent.

When the SIP/IP Core corresponds with 3GPP/3GPP2 IMS, the PoC Server SHALL use 3GPP/3GPP2 IMS mechanisms according to rules and procedures of [3GPP TS 24.229] / [3GPP2 X.S0013.4] with the clarifications given in this subclause.

7.2.1.3 Pre-arranged PoC Group Session setup request

This subclause describes the procedures that the PoC Server follows for the establishment of a Pre-arranged PoC Group Session.

Subclause 7.2.1.3.1: "General" is the starting point for the establishment of all Pre-arranged PoC Group Sessions.

Subclause 7.2.1.3.2: "Dispatch PoC Session setup request from PoC Dispatcher" describes the specific procedures to be followed, when indicated from subclause 7.2.1.3.1 "General", for the establishment of a Dispatch PoC Session initiated by a PoC Dispatcher

Subclause 7.2.1.3.3: "Dispatch PoC Session setup request from PoC Fleet Member" describes the specific procedures to be followed, when indicated from subclause 7.2.1.3.1 "General", for the establishment of a Dispatch PoC Session initiated by a PoC Fleet Member

7.2.1.3.1 General

NOTE 1: This subclause provides common procedures for other subclauses and is not meant to be applied unless referenced.

Upon receiving an initial SIP INVITE request the PoC Server:

- 1. MAY reject the SIP INVITE request with a SIP 503 "Service Unavailable" response depending on the value of the requested QoE Profile if QoE Profiles are enabled, the PoC Group does not already have an on-going PoC Session and a risk of congestion exists as specified in [OMA-PoC-UP] "Procedures at the PoC Server performing the Controlling PoC Function". The PoC Server MAY include a Retry-After header to the 503 "Service Unavailable" response as specified in [RFC3261];;

NOTE 2: The PoC Client is allowed to re-attempt the PoC Session establishment after the time defined by the Retry-After header.

- 2. SHALL check whether the Accept-Contact header includes the PoC feature tag '+g.poc.talkburst' and if it is not included the PoC Server SHALL return a SIP 403 "Forbidden" response with the warning text set to '120 Routing error in network' as specified in subclause 5.6 "Warning header". Otherwise, continue with the rest of the steps;
- 3. SHALL perform actions to verify the Authenticated Originator's PoC Address of the Inviting PoC User and authorize the request as specified in subclause 7.2.1.14 "PoC Session initiation policy" and if it is not authorized the PoC Server SHALL return a SIP 403 "Forbidden" response with the warning text set to '121 Function not allowed due to <detailed reason>' as specified in subclause 5.6 "Warning header". Otherwise, continue with the rest of the steps;
- 4. SHALL check if the URI Usage Type uri-parameter is included in the Request-URI and if it is included with a value different from "uriusage=group" the PoC Server performing the Controlling PoC Function SHALL return a SIP 403 "Forbidden" response according to the rules and procedures of [RFC3261] with the warning text set to '130 Conflicting URI: <URI>' as specified in subclause 5.6 "Warning header". Otherwise, continue with the rest of the steps;
- 5. SHALL check the presence of the 'isfocus' feature parameter in the URI of the Contact header and if it is present then the PoC Server performing the Controlling PoC Function SHALL return a SIP 403 "Forbidden" response according to the rules and procedures of [draft-URI-list-handling] containing the list of members of the Pre-arranged PoC Group. Otherwise, continue with the rest of the steps;

NOTE 3: If the sender of the INVITE request is a Release 1.0 PoC Server, the procedure specified in [OMA-POC-1-CP] is used instead.

- 6. SHALL check whether privacy is allowed for the Authenticated Originator's PoC Address, when anonymity is requested with the Privacy header containing the value 'id'. If not allowed, the PoC Server SHALL respond with a SIP 403 "Forbidden" response with the warning text set to '119 Anonymity not allowed' as specified in subclause 5.6 "Warning header" to the originating network. Allowing privacy for a specific Authenticated Originator's PoC Address is defined using <allow-anonymity> element of the PoC Group's authorization rules as specified in [OMA-PoC-Document-Mgmt]. If privacy is allowed, the PoC Server SHALL create and cache an Anonymous PoC Address as specified in subclause 5.9 "Anonymous PoC Address" and a Nick Name as specified in subclause 5.4 "Nick Name" for the Inviting PoC User. Otherwise, continue with the rest of the steps;

NOTE 4: The Anonymous PoC Address is an alias for the PoC User, and this address appears in Participant Information and the User Plane Taken message. This alias PoC Address is used when expelling the Participant from the PoC Session.

- 7. SHALL, if the PoC Dispatcher functionality is supported, check whether any of the PoC Users contained in the <list> element of the Pre-arranged PoC Group document is allowed the action <allow-dispatch> as specified in [OMA-PoC-Document-Mgmt]:
 - a) If it is allowed for at least one group member, the PoC Server SHALL check whether the Contact header of the incoming SIP INVITE request includes the PoC Dispatcher feature tag '+g.poc.dispatcher' according to rules and procedures of [RFC3840]. If it is present, the PoC Server SHALL proceed as specified in subclause 7.2.1.3.2 "Dispatch PoC Session setup request from PoC Dispatcher" and do not continue with the rest of the steps. If it is not present, the PoC Server SHALL proceed as specified in subclause 7.2.1.3.3 "Dispatch PoC Session setup request from PoC Fleet Member" and do not continue with the rest of the steps; and,
 - b) If it is not allowed for any group member, continue with the rest of the steps.
- 8. SHOULD check whether the "b=AS" attribute is included in the SDP offer, and if it is, use the attribute as specified in [OMA-PoC-UP] "Media Buffering";
- 9. if the PoC Group does not have already an on-going PoC Session, the PoC Server:
 - a) SHALL validate that the received SDP offer includes at least one Media Stream allowed as specified in subclause 7.2.1.21 "Policy for allowing Media Streams in a PoC Session" for which the Media Parameters and at least one codec or Media format is acceptable for the PoC Server and if not reject the request with a SIP 488 "Not Acceptable Here" response generated as specified in the subclause 7.2.1.1 "General". Otherwise, continue with the rest of the steps;

- b) SHALL check if a Resource-Priority header is included in the SIP INVITE request, according to rules and procedures of [RFC4412], if the 'Official Government Use' QoE Profile is supported. If included the PoC Server SHALL:
- i. check that the QoE Profile attribute contained in the SDP offer indicates 'Official Government Use' QoE Profile, as specified in subclause E.3.2 "*QoE Profile*". If the QoE Profile attribute indicates other QoE Profile, the PoC Server SHALL reject the request with a SIP 403 "Forbidden" response with the warning text set to '114 QoE Assignment Error' as specified in subclause 5.6 "*Warning header*";
 - ii. assign 'Official Government Use' QoE Profile as the QoE Profile for the PoC Session; and,
 - iii. apply any preferential treatment to the SIP request as specified in [RFC4412], skip the next step and proceed with the rest of the steps.
- c). SHALL, if QoE Profiles are enabled,
- i. if there is no <qoe> element defined in the PoC Group document as specified in [OMA-PoC-Documents-Mgmt], assign the QoE Profile indicated in the QoE Profile attribute in the SDP offer as the QoE Profile of the PoC Session; and,
 - ii if there is a <qoe> element defined in the PoC Group document as specified in [OMA-PoC-Documents-Mgmt], check whether the value of the QoE Profile attribute in the SDP offer is equal or higher, as specified in 5.8 "*QoE Profiles*", than the value of the <qoe> element. If it is lower the PoC Server SHALL reject the SIP INVITE request with a SIP 403 "Forbidden" response with the warning text set to '114 QoE Assignment Error' as specified in subclause 5.6 "*Warning header*". Otherwise, the PoC Server SHALL assign the value of the <qoe> element as the QoE Profile of the PoC Session and SHALL mark it as "mandatory" and continue with the rest of the steps.

NOTE 5: If no QoE Profile attribute is included in the SDP offer of the SIP INVITE request, it is considered that 'Basic' QoE Profile is requested.

- d) SHALL, if Included Media Content is supported by the PoC Server and if media content is received in one or more MIME bodies,
- i. Check if included Media Type is allowed, using a local policy, and if at least one Media Type is not allowed, the PoC Server SHALL, based on a Service Provider Policy either,
 1. send a SIP 415 "Unsupported Media Type" response, the SIP 415 "Unsupported Media Type" response SHALL include:
 - a) the Accept header with the acceptable Media-Types that the PoC Server would accept according to rules and procedures of [RFC3261]; or,
 - b) the Accept-Encoding header with the encoding formats that the PoC Server would accept according to rules and procedures of [RFC3261]; or,
 - c) both.

and do not continue with the rest of the steps; or,

2. remove the MIME bodies containing the media content that is not allowed.

NOTE 6: One example of a local policy could be that the PoC Server only allows Included Media Content in special traffic scenarios.

- ii. Check the total size of all MIME bodies containing media content and if the total size exceeds a configurable max size, based on a Service Provider policy either,
 1. send a SIP 413 "Request Entity Too Large" response and do not continue with the rest of the steps; or,
 2. remove all MIME bodies containing media content.
- e) MAY remove the Subject header;
- f) MAY remove the Alert-Info or the Call-Info header or both;

NOTE 7: The reason for removing the Alert-Info header or the Call-Info header or both may be a local policy in the PoC Server.

- g) SHALL invite members of the Pre-arranged PoC Group as specified in subclauses 7.2.1.14 "PoC Session initiation policy" and 7.2.2.2 "PoC Session invitation requests"; and,
- h) SHALL interact with User Plane as specified in [OMA-PoC-UP] "Controlling PoC Function procedures at PoC Session initialization" and do not continue the rest of the steps.
- 10. if the PoC Group has already an Active PoC Session, the PoC Server:
- a) SHALL validate that the received SDP offer includes at least one Media Stream used in the PoC Session with the Media-floor Control binding as used in the PoC Session, for which the Media Parameters and at least one codec or Media format is acceptable for the PoC Server and if not, reject the request with a SIP 488 "Not Acceptable Here" response generated as specified in the subclause 7.2.1.1 "General". Otherwise, continue with the rest of the steps;
- b) SHALL check whether the Authenticated Originator's PoC Address of the joining PoC User is allowed to join by performing the actions specified in subclause 7.2.1.6 "PoC Session joining policy". If it is not allowed to join the PoC Server performing the Controlling PoC Function SHALL respond with a SIP 403 "Forbidden" response with the warning text set to '121 Function not allowed due to <detailed reason>' as specified in subclause 5.6 "Warning header" to the originating network. Otherwise, continue with the rest of the steps;
- c) SHALL check if a Resource-Priority header is included in the SIP INVITE request, according to rules and procedures of [RFC4412], if the 'Official Government Use' QoE Profile is supported. If included the PoC Server SHALL:
- i. check that the QoE Profile attribute contained in the SDP offer indicates 'Official Government Use' QoE Profile, as specified in subclause E.3.2 "QoE Profile". If the QoE Profile attribute indicates other QoE Profile, the PoC Server SHALL reject the request with a SIP 403 "Forbidden" response with the warning text set to '114 QoE Assignment Error' as specified in subclause 5.6 "Warning header". Otherwise, continue with the rest of the steps;
- ii. apply any preferential treatment to the SIP request as specified in [RFC4412], skip the next step and proceed with the rest of the steps.
- d) SHALL check for a QoE Profile attribute contained in the request, if QoE Profiles are enabled. If the included QoE Profile is lower, as specified in subsection 5.8 "QoE Profiles" than the QoE Profile assigned to the Active PoC Session and if the QoE Profile assigned to the Active PoC Session is marked as "mandatory", the PoC Server SHALL reject the request with a SIP 403 "Forbidden" response with the warning text set to '114 QoE Assignment Error' as specified in subclause 5.6 "Warning header". Otherwise, continue with the rest of the steps;
- e) SHALL check if <max-participant-count> as specified in [OMA-PoC-Document-Mgmt] is already reached. If reached:
- i. If the PoC Server supports 'Official Government Use' QoE Profile, and if the incoming invitation requests an 'Official Government Use' Local QoE Profile with an associated PoC Session Precedence that is higher than the PoC Session Precedence associated to the Local QoE Profile of at least one of the participants of the PoC Session, then according to Service Provider Policy the PoC Server MAY release a participant of lowest Local QoE Profile, as specified in subclause 7.2.2.4 "Removal of Participant from PoC Session", and skip the next step;
- ii. The PoC Server SHALL return a SIP 486 "Busy Here" response with the warning text set to '102 Too many participants' to the originating network as specified in subclause 5.6 "Warning header". Otherwise, continue with the rest of the steps;
- f) SHALL generate a SIP 200 "OK" response as specified in the 7.2.1.1 "General";
- g) SHALL include in the SIP 200 "OK" response a MIME SDP body as an SDP answer to the SDP offer in the incoming SIP INVITE request as specified in the subclause 7.2.1.1a "SDP answer generation";
- h) SHALL include in the SIP 200 "OK" response with the warning text set to '116 PoC Session already exists' as specified in subclause 5.6 "Warning header";

NOTE 8: Resulting User Plane processing is completed before the next step is performed

- i) SHALL interact with User Plane as specified in [OMA-PoC-UP] "Controlling PoC Function procedures at PoC Session initialization";

- j) SHALL send the SIP 200 "OK" response towards the Inviting PoC Client according to rules and procedures of the SIP/IP Core;
- k) SHALL generate a notification to the PoC Clients, which have subscribed to the conference state event package that the Inviting PoC User has joined in the PoC Group Session, as specified in subclause 7.2.1.11.2 "Generating a SIP NOTIFY request"; and,
- l) SHALL send the SIP NOTIFY request to the PoC Clients according to rules and procedures of the SIP/IP Core.

Upon receiving a SIP 183 "Session Progress" response for the SIP INVITE request containing a P-Answer-State header with the value "Unconfirmed" as specified in [RFC4964] and as specified in subclause 7.2.2.2 "PoC Session Invitation Requests" the PoC Server:

- 1. SHALL generate a SIP 200 "OK" response to SIP INVITE request as specified in the subclause 7.2.1.1 "General" and continue with the rest of the steps if unconfirmed mode is supported by the PoC Server and the SIP final response is not yet sent to the Inviting PoC Client, otherwise do not proceed with the rest of the steps;
- 2. SHALL include the warning text set to '103 Too many group members' as specified in subclause 5.6 "Warning header" in the SIP 200 "OK" response, if the Pre-arranged PoC Group has more than <max-participant-count> members as specified in [OMA-PoC-Document-Mgmt].
- 3. SHALL include in the SIP 200 "OK" response a MIME SDP body as an SDP answer to the SDP offer in the incoming SIP INVITE request as specified in the subclause 7.2.1.1a "SDP answer generation";
- 4. SHALL include a P-Answer-State header with the value "Unconfirmed";
- 5. SHALL, in case the Pre-arranged PoC Group Session is a Dispatch PoC Session, include in the Authenticated Originator's PoC Address and in the Contact header the Dispatch Type uri-parameter "dispatch=entire-group" or "dispatch=sub-group" as appropriate for the type of the Dispatch PoC Session, as specified in E.5.2 "Dispatch Type uri-parameter";
- 6. SHALL interact with the User Plane as specified in [OMA-PoC-UP] "Controlling PoC Function procedures at PoC Session initialization";

NOTE 9: Resulting User Plane processing is completed before the next step is performed.

- 7. SHALL send the SIP 200 "OK" response towards the Inviting PoC Client according to rules and procedures of the SIP/IP Core;
- 8. SHALL generate a notification to the PoC Clients, which have subscribed to the conference state event package that the Inviting PoC User has joined in the PoC Group Session, as specified in subclause 7.2.1.11.2 "Generating a SIP NOTIFY request"; and
- 9. SHALL send the SIP NOTIFY request to the PoC Clients according to rules and procedures of the SIP/IP Core.

Upon receiving a SIP 180 "Ringing" response as specified in subclause 7.2.2.2 "PoC Session invitation requests" and the SIP final response or a SIP 180 "Ringing" response has not yet been sent to the Inviting PoC Client, the PoC Server:

- 1. SHALL generate a SIP 180 "Ringing" to the SIP INVITE request response as specified in the subclause 7.2.1.1 "General";
- 2. SHALL, in case the Pre-arranged PoC Group Session is a Dispatch PoC Session, include in the Authenticated Originator's PoC Address and in the Contact header the Dispatch Type uri-parameter "dispatch=entire-group" or "dispatch=sub-group" as appropriate for the type of the Dispatch PoC Session, as specified in E.5.2 "Dispatch Type uri-parameter"; and,
- 3. SHALL send the SIP 180 "Ringing" response towards the Inviting PoC Client according to rules and procedures of the SIP/IP Core.

Upon receiving a SIP 200 "OK" response for the SIP INVITE request as specified in subclause 7.2.2.2 "PoC Session invitation requests" and if the SIP final response has not yet been sent to the Inviting PoC Client the PoC Server:

- 1. SHALL generate SIP 200 "OK" response to the SIP INVITE request as specified in the subclause 7.2.1.1 "General" before continuing with the rest of the steps;
- 2. SHALL include the warning text set to '103 Too many group members' as specified in subclause 5.6 "Warning header" in the SIP 200 "OK" response, if all members were not invited because the Pre-arranged PoC Group has exceeded the <max-participant-count> members as specified in [OMA-PoC-Document-Mgmt].

- 3. SHALL, in case the Pre-arranged PoC Group Session is a Dispatch PoC Session, include in the Authenticated Originator's PoC Address and in the Contact header the Dispatch Type uri-parameter "dispatch=entire-group" or "dispatch=sub-group" as appropriate for the type of the Dispatch PoC Session, as specified in E.5.2 "Dispatch Type uri-parameter".
- 4. SHALL include in the SIP 200 "OK" response a MIME SDP body as an SDP answer to the SDP offer in the incoming SIP INVITE request as specified in the subclause 7.2.1.1a "SDP answer generation";
- 5. SHALL interact with the User Plane as specified in [OMA-PoC-UP] "Controlling PoC Function procedures at PoC Session initialization";

NOTE 10: Resulting User Plane processing is completed before the next step is performed.

- 6. SHALL send a SIP 200 "OK" response to the Inviting PoC Client according to rules and procedures of the SIP/IP Core.;
- 7. SHALL generate a notification to the PoC Clients, which have subscribed to the conference state event package that the Inviting PoC User has joined in the PoC Group Session, as specified in subclause 7.2.1.11.2 "Generating a SIP NOTIFY request"; and,
- 8. SHALL send the SIP NOTIFY request to the PoC Clients according to rules and procedures of the SIP/IP Core.

Upon receiving a SIP final response other than 2xx or 3xx that is one of the SIP 4xx, 5xx or 6xx final responses the PoC Server:

- 1. SHALL perform either of the following:
 - a) send the SIP final response towards the Inviting PoC Client, according to rules and procedures of the SIP/IP Core, if a SIP final response was received from all the Invited PoC Clients and the SIP 200 "OK" response is not yet sent. The SIP final response SHALL include the Status-Code defined by the PoC Server according to local policy e.g. the lowest value received from the Invited PoC User(s); or,
 - b) remove the Inviting PoC Client from the PoC Session as specified in subclause 7.2.2.4 "Removal of Participant from PoC Session", if a SIP final response other than 2xx or 3xx was received from all the Invited PoC Clients and the SIP 200 "OK" response is already sent.
- 2. MAY invite an additional member of the Pre-arranged PoC Group as specified in subclause 7.2.2.2 "PoC Session invitation request" that has not already been invited, if the Pre-arranged PoC Group has more than <max-participant-count> members as specified in [OMA-PoC-Document-Mgmt], and all members have not yet been invited.

When the SIP/IP Core corresponds with 3GPP/3GPP2 IMS, the PoC Server SHALL use 3GPP/3GPP2 IMS mechanisms according to rules and procedures of [3GPP TS 24.229] / [3GPP2 X.S0013.4] with the clarifications given in this subclause.

7.2.1.3.2 Dispatch PoC Session setup request from PoC Dispatcher

Upon receiving an initial SIP INVITE request to establish a Dispatch PoC Session from a PoC Dispatcher, as specified in subclause 7.2.1.3.1 "General", the PoC Server:

- 1. SHALL perform actions to verify the Authenticated Originator's PoC Address of the Inviting PoC User and authorize the request as specified in subclause 7.2.1.14.2 "Dispatch PoC Session initiation policy for PoC Dispatcher" and if it is not authorized the PoC Server SHALL return a SIP 403 "Forbidden" response with the warning text set to '113 User is not a dispatcher for the group' as specified in subclause 5.6 "Warning header". Otherwise, continue with the rest of the steps;
- 2. SHALL check whether privacy is allowed for the Authenticated Originator's PoC Address, when anonymity is requested with the Privacy header containing the value 'id'. If not allowed, the PoC Server SHALL respond with a SIP 403 "Forbidden" response with the warning text set to '119 Anonymity not allowed' as specified in subclause 5.6 "Warning header" to the originating network. Allowing privacy for a specific Authenticated Originator's PoC Address is defined using <allow-anonymity> element of the PoC Group's authorization rules as specified in [OMA-PoC-Document-Mgmts]. Otherwise, continue with the rest of the steps;
- 3. SHALL check the presence of the Dispatch Type uri-parameter in the Request-URI, and
 - a) if the Dispatch Type uri-parameter is present and its value is understood, the PoC Server SHALL consider the received value as the Dispatch Type uri-parameter for the Dispatch PoC Session; or
 - b) if the Dispatch Type uri-parameter is present but its value is unknown, the PoC Server SHALL reject the SIP INVITE request with a SIP 404 "Not Found" response and do not continue with the rest of the steps.

- 4. SHALL, if Included Media Content is supported by the PoC Server and if media content is received in one or more MIME bodies,
 - a) Check if included Media Type is allowed, using a local policy, and if at least one Media Type is not allowed, the PoC Server SHALL, based on a Service Provider Policy either,
 - i. send a SIP 415 "Unsupported Media Type" response, the SIP 415 "Unsupported Media Type" response SHALL include:
 - 1. the Accept header with the acceptable Media-Types that the PoC Server would accept according to rules and procedures of [RFC3261]; or,
 - 2. the Accept-Encoding header with the encoding formats that the PoC Server would accept according to rules and procedures of [RFC3261]; or,
 - 3. both.
 - and do not continue with the rest of the steps; or,
 - ii. remove the MIME bodies containing the media content that is not allowed.

NOTE 1: One example of a local policy could be that the PoC Server only allows Included Media Content in special traffic scenarios.

- b) Check the total size of all MIME bodies containing media content and if the total size exceeds a configurable max size, based on a Service Provider policy either,
 - i. send a SIP 413 "Request Entity Too Large" response and do not continue with the rest of the steps; or,
 - ii. remove all MIME bodies containing media content.
- 5. SHOULD use the "b=AS" attribute as specified in [OMA-PoC-UP] "*Media Buffering*", if included in the SDP offer;
- 6. MAY remove the Subject header;
- 7. MAY remove the Alert-Info or the Call-Info header or both;

NOTE 2: The reason for removing the Alert-Info header or the Call-Info header or both may be a local policy in the PoC Server.

- 8. If the Dispatch PoC Group does not have already any on-going Dispatch PoC Session the PoC Server:
 - a) SHALL validate that the received SDP offer includes at least one Media Stream allowed as specified in subclause 7.2.1.21 "*Policy for allowing Media Streams in a PoC Session*" for which the Media Parameters and at least one codec or Media format is acceptable for the PoC Server and if not reject the request with a SIP 488 "Not Acceptable Here" response generated as specified in the subclause 7.2.1.1 "*General*". Otherwise, continue with the rest of the steps;
 - b) SHALL check if a Resource-Priority header is included in the SIP INVITE request, according to rules and procedures of [RFC4412], if the 'Official Government Use' QoE Profile is supported. If included the PoC Server SHALL:
 - i. check that the QoE Profile attribute contained in the SDP offer indicates 'Official Government Use' QoE Profile, as specified in subclause E.3.2 "*QoE Profile*". If the QoE Profile attribute indicates other QoE Profile, the PoC Server SHALL reject the request with a SIP 403 "Forbidden" response with the warning text set to '114 QoE Assignment Error' as specified in subclause 5.6 "*Warning header*";
 - ii. assign 'Official Government Use' QoE Profile as the QoE Profile for the Dispatch PoC Session; and,
 - iii. apply any preferential treatment to the SIP request as specified in [RFC4412], skip step c and proceed with the rest of the steps.
 - c) SHALL, if QoE Profiles are enabled,
 - i. if there is no <qoe> element defined in the PoC Group document as specified in [OMA-PoC-Documents-Mgmt], assign the QoE Profile indicated in the QoE Profile attribute in the SDP offer as the QoE Profile of the Dispatch PoC Session; and,
 - ii. if there is a <qoe> element defined in the PoC Group document as specified in [OMA-PoC-Documents-Mgmt], check whether the value of the QoE Profile attribute in the SDP offer is equal or higher, as specified in 5.8 "*QoE Profiles*", than the value of the <qoe> element. If it is lower the PoC Server SHALL

reject the SIP INVITE request with a SIP 403 "Forbidden" response with the warning text set to '114 QoE Assignment Error' as specified in subclause 5.6 "Warning header". Otherwise, the PoC Server SHALL assign the value of the <qoe> element as the QoE Profile of the Dispatch PoC Session and SHALL mark it as "mandatory" and continue with the rest of the steps.

NOTE 3: If no QoE Profile attribute is included in the SDP offer of the SIP INVITE request, it is considered that 'Basic' QoE Profile is requested.

- d) If the Dispatch Type uri-parameter is "dispatch=sub-group", then the PoC Server:
 - i. SHALL allocate a PoC Session Identity for the PoC Session; and,
 - ii. SHALL invite the PoC Users listed in the MIME resource-lists body as specified in subclauses 7.2.1.14.2 "Dispatch PoC Session initiation policy for PoC Dispatcher" and 7.2.2.2 "PoC Session invitation requests".
- e) If the Dispatch Type uri-parameter is "dispatch=entire-group", the PoC Server SHALL invite members of the Dispatch PoC Group as specified in subclauses 7.2.1.14.2 "Dispatch PoC Session initiation policy for PoC Dispatcher" and 7.2.2.2 "Dispatch PoC Session invitation requests".
- 9. If the Dispatch PoC Group has already one or more on-going Dispatch PoC Session, then the PoC Server:
 - a) SHALL check whether the inviting PoC User is the Active PoC Dispatcher for the other on-going Dispatch PoC Sessions. If not, the PoC Server SHALL reject the request with as SIP 486 "Busy Here" response with the warning text set to '110 Dispatch group has already another active dispatcher' as specified in subclause 5.6 "Warning header". Otherwise, continue with the rest of the steps;
 - b) If the Dispatch Type uri-parameter is "dispatch=sub-group", the PoC Server
 - i. SHALL check if a Resource-Priority header is included in the SIP INVITE request, according to rules and procedures of [RFC4412], if the 'Official Government Use' QoE Profile is supported. If included the PoC Server SHALL:
 1. check that the QoE Profile attribute contained in the SDP offer indicates 'Official Government Use' QoE Profile, as specified in subclause E.3.2 "QoE Profile". If the QoE Profile attribute indicates other QoE Profile, the PoC Server SHALL reject the request with a SIP 403 "Forbidden" response with the warning text set to '114 QoE Assignment Error' as specified in subclause 5.6 "Warning header";
 2. assign 'Official Government Use' QoE Profile as the QoE Profile for the Dispatch PoC Session; and,
 3. apply any preferential treatment to the SIP request as specified in [RFC4412], skip step ii and proceed with the rest of the steps.
 - ii. SHALL, if QoE Profiles are enabled,
 1. if there is no <qoe> element defined in the PoC Group document as specified in [OMA-PoC-Document-Mgmt], assign the QoE Profile indicated in the QoE Profile attribute in the SDP offer as the QoE Profile of the Dispatch PoC Session; and,
 2. if there is a <qoe> element defined in the PoC Group document as specified in [OMA-PoC-Document-Mgmt], check whether the value of the QoE Profile attribute in the SDP offer is equal or higher, as specified in 5.8 "QoE Profiles", than the value of the <qoe> element. If it is lower the PoC Server SHALL reject the SIP INVITE request with a SIP 403 "Forbidden" response with the warning text set to '114 QoE Assignment Error' as specified in subclause 5.6 "Warning header". Otherwise, the PoC Server SHALL assign the value of the <qoe> element as the QoE Profile of the Dispatch PoC Session and SHALL mark it as "mandatory" and continue with the rest of the steps.

NOTE 4: If no QoE Profile attribute is included in the SDP offer of the SIP INVITE request, it is considered that 'Basic' QoE Profile is requested.

- iii. SHALL validate that the received SDP offer includes at least one Media Stream allowed as specified in subclause 7.2.1.21 "Policy for allowing Media Streams in a PoC Session" for which the Media Parameters and at least one codec or Media format is acceptable for the PoC Server and if not reject the request with a SIP 488 "Not Acceptable Here" response generated as specified in the subclause 7.2.1.1 "General". Otherwise, continue with the rest of the steps;
- iv. SHALL allocate a PoC Session Identity for the PoC Session; and,
- v. SHALL invite the PoC Users listed in the MIME resource-lists body as specified in subclauses 7.2.1.14.2 "Dispatch PoC Session initiation policy for PoC Dispatcher" and 7.2.2.2 "PoC Session invitation requests".

- c) If the Dispatch Type uri-parameter is "dispatch=entire-group", and
- i. If any of the already on-going Dispatch PoC Sessions is established with the entire Dispatch PoC Group, the PoC Server SHALL reject the request with as SIP 486 "Busy Here" response. Otherwise continue with the rest of the steps; and,
 - ii. SHALL check if a Resource-Priority header is included in the SIP INVITE request, according to rules and procedures of [RFC4412], if the 'Official Government Use' QoE Profile is supported. If included the PoC Server SHALL:
 1. check that the QoE Profile attribute contained in the SDP offer indicates 'Official Government Use' QoE Profile, as specified in subclause E.3.2 "*QoE Profile*". If the QoE Profile attribute indicates other QoE Profile, the PoC Server SHALL reject the request with a SIP 403 "Forbidden" response with the warning text set to '114 QoE Assignment Error' as specified in subclause 5.6 "*Warning header*";
 2. assign 'Official Government Use' QoE Profile as the QoE Profile for the Dispatch PoC Session; and,
 3. apply any preferential treatment to the SIP request as specified in [RFC4412], skip step iii and proceed with the rest of the steps.
 - iii. SHALL, if QoE Profiles are enabled,
 1. if there is no <qoe> element defined in the PoC Group document as specified in [OMA-PoC-Document-Mgmt], assign the QoE Profile indicated in the QoE Profile attribute in the SDP offer as the QoE Profile of the Dispatch PoC Session; and,
 2. if there is a <qoe> element defined in the PoC Group document as specified in [OMA-PoC-Document-Mgmt], check whether the value of the QoE Profile attribute in the SDP offer is equal or higher, as specified in 5.8 "*QoE Profiles*", than the value of the <qoe> element. If it is lower the PoC Server SHALL reject the SIP INVITE request with a SIP 403 "Forbidden" response with the warning text set to '114 QoE Assignment Error' as specified in subclause 5.6 "*Warning header*". Otherwise, the PoC Server SHALL assign the value of the <qoe> element as the QoE Profile of the Dispatch PoC Session and SHALL mark it as "mandatory" and continue with the rest of the steps.

NOTE 5: If no QoE Profile attribute is included in the SDP offer of the SIP INVITE request, it is considered that 'Basic' QoE Profile is requested.

NOTE 6: Dispatch PoC Session with the entire Dispatch PoC Group are only established when the inviting PoC Dispatcher indicates the Dispatch Type uri-parameter "dispatch=entire-group" or no MIME resource-lists body is included in the SIP INVITE request

- iv. SHALL validate that the received SDP offer includes at least one Media Stream allowed as specified in subclause 7.2.1.21 "*Policy for allowing Media Streams in a PoC Session*" for which the Media Parameters and at least one codec or Media format is acceptable for the PoC Server and if not reject the request with a SIP 488 "Not Acceptable Here" response generated as specified in the subclause 7.2.1.1 "*General*". Otherwise, continue with the rest of the steps; and,
 - v. If none of the already on-going Dispatch PoC Sessions is established with the entire Dispatch PoC Group, the PoC Server SHALL invite members of the Dispatch PoC Group as specified in subclauses 7.2.1.14.2 "*Dispatch PoC Session initiation policy for PoC Dispatcher*" and 7.2.2.2 "*Dispatch PoC Session invitation requests*".
- 11. SHALL interact with User Plane as specified in [OMA-PoC-UP] "*Controlling PoC Function procedures at PoC Session initialization*".

Upon receiving a SIP response for the SIP INVITE request, as specified in subclause 7.2.2.2 "*PoC Session invitation requests*", the PoC Server SHALL proceed as specified in subclause 7.2.1.3.1 "*General*".

When the SIP/IP Core corresponds with 3GPP/3GPP2 IMS, the PoC Server SHALL use 3GPP/3GPP2 IMS mechanisms according to rules and procedures of [3GPP TS 24.229] / [3GPP2 X.S0013.4] with the clarifications given in this subclause.

7.2.1.3.3 Dispatch PoC Session setup request from PoC Fleet Member

Upon receiving an initial SIP INVITE request to establish a Dispatch PoC Session from a PoC Fleet Member, as specified in subclause 7.2.1.3.1 "*General*", the PoC Server:

- 1. SHALL perform actions to verify the Authenticated Originator's PoC Address of the Inviting PoC User and authorize the request as specified in subclause 7.2.1.14.3 "*Dispatch PoC Session initiation policy for PoC Fleet Member*" and if it is not authorized the PoC Server SHALL return a SIP 403 "Forbidden" response with the warning text set to '121 Function not allowed due to <detailed reason>' as specified in subclause 5.6 "*Warning header*". Otherwise, continue with the rest of the steps;
 - 2. SHALL check whether privacy is allowed for the Authenticated Originator's PoC Address, when anonymity is requested with the Privacy header containing the value 'id'. If not allowed, the PoC Server SHALL respond with a SIP 403 "Forbidden" response with the warning text set to '119 Anonymity not allowed' as specified in subclause 5.6 "*Warning header*" to the originating network. Allowing privacy for a specific Authenticated Originator's PoC Address is defined using <allow-anonymity> element of the PoC Group's authorization rules as specified in [OMA-PoC-Documents-Mgmt]. Otherwise, continue with the rest of the steps;
 - 3. SHOULD use the "b=AS" attribute as specified in [OMA-PoC-UP] "*Media Buffering*", if included in the SDP offer;
 - 4. If the Dispatch PoC Group does not have already any on-going Dispatch PoC Session with the entire Dispatch PoC Group, then the PoC Server:
 - a) SHALL validate that the received SDP offer includes at least one Media Stream allowed as specified in subclause 7.2.1.21 "*Policy for allowing Media Streams in a PoC Session*" for which the Media Parameters and at least one codec or Media format is acceptable for the PoC Server and if not reject the request with a SIP 488 "Not Acceptable Here" response generated as specified in the subclause 7.2.1.1 "*General*". Otherwise, continue with the rest of the steps;
 - b) SHALL, if Included Media Content is supported by the PoC Server and if media content is received in one or more MIME bodies,
 - i. Check if included Media Type is allowed, using a local policy, and if at least one Media Type is not allowed, the PoC Server SHALL, based on a Service Provider Policy either,
 - 1. send a SIP 415 "Unsupported Media Type" response, the SIP 415 "Unsupported Media Type" response SHALL include:
 - a) the Accept header with the acceptable Media-Types that the PoC Server would accept according to rules and procedures of [RFC3261]; or,
 - b) the Accept-Encoding header with the encoding formats that the PoC Server would accept according to rules and procedures of [RFC3261]; or,
 - c) both.
- and do not continue with the rest of the steps; or,
- 2. remove the MIME bodies containing the media content that is not allowed.

NOTE 1: One example of a local policy could be that the PoC Server only allows Included Media Content in special traffic scenarios.

- ii. Check the size of all MIME bodies containing media and if the total size exceeds a configurable max size, based on a Service Provider policy either,
 - 1. send a SIP 413 "Request Entity Too Large" response and do not continue with the rest of the steps; or,
 - 2. remove all MIME bodies containing media content.
- c) MAY remove the Subject header;
- d) MAY remove the Alert-Info or the Call-Info header;

NOTE 2: The reason for removing the Alert-Info header or the Call-Info header or both may be a local policy in the PoC Server.

- e) SHALL use the value "dispatch=sub-group" as the Dispatch Type uri-parameter for the Dispatch PoC Session;

- f) SHALL check if a Resource-Priority header is included in the SIP INVITE request, according to rules and procedures of [RFC4412], if the 'Official Government Use' QoE Profile is supported. If included the PoC Server SHALL:
- i. check that the QoE Profile attribute contained in the SDP offer indicates 'Official Government Use' QoE Profile, as specified in subclause E.3.2 "*QoE Profile*". If the QoE Profile attribute indicates other QoE Profile, the PoC Server SHALL reject the request with a SIP 403 "Forbidden" response with the warning text set to '114 QoE Assignment Error' as specified in subclause 5.6 "*Warning header*";
 - ii. assign 'Official Government Use' QoE Profile as the QoE Profile for the Dispatch PoC Session; and,
 - iii. apply any preferential treatment to the SIP request as specified in [RFC4412], skip step g and proceed with the rest of the steps.
- g) SHALL, if QoE Profiles are enabled,
- i. if there is no <qoe> element defined in the PoC Group document as specified in [OMA-PoC-Documents-Mgmt], assign the QoE Profile indicated in the QoE Profile attribute in the SDP offer as the QoE Profile of the Dispatch PoC Session; and,
 - ii. if there is a <qoe> element defined in the PoC Group document as specified in [OMA-PoC-Documents-Mgmt], check whether the value of the QoE Profile attribute in the SDP offer is equal or higher, as specified in 5.8 "*QoE Profiles*", than the value of the <qoe> element. If it is lower the PoC Server SHALL reject the SIP INVITE request with a SIP 403 "Forbidden" response with the warning text set to '114 QoE Assignment Error' as specified in subclause 5.6 "*Warning header*". Otherwise, the PoC Server SHALL assign the value of the <qoe> element as the QoE Profile of the Dispatch PoC Session and SHALL mark it as "mandatory" and continue with the rest of the steps.

NOTE 3: If no QoE Profile attribute is included in the SDP offer of the SIP INVITE request, it is considered that 'Basic' QoE Profile is requested.

- h) SHALL invite one member of the Dispatch PoC Group that is allowed the action <allow-dispatch>, as specified in subclauses 7.2.1.14.3 "*Dispatch PoC Session initiation policy for PoC Fleet Member*" and 7.2.2.2 "*PoC Session invitation requests*"; and,
- i) SHALL interact with User Plane as specified in [OMA-PoC-UP] "*Controlling PoC Function procedures at PoC Session initialization*" and do not continue the rest of the steps.
- 5. If the Dispatch PoC Group has already an on-going Dispatch PoC Session with the entire Dispatch PoC Group, the PoC Server:
- a) SHALL validate that the received SDP offer includes at least one Media Stream used in the PoC Session with the Media-floor Control binding as used in the PoC Session for which the Media Parameters and at least one codec or Media format is acceptable for the PoC Server and if not, reject the request with a SIP 488 "Not Acceptable Here" response generated as specified in the subclause 7.2.1.1 "*General*". Otherwise, continue with the rest of the steps;
 - b) SHALL check whether the Authenticated Originator's PoC Address of the joining PoC User is allowed to join by performing the actions specified in subclause 7.2.1.6 "*PoC Session joining policy*". If it is not allowed to join the PoC Server performing the Controlling PoC Function SHALL respond with a SIP 403 "Forbidden" response with the warning text set to '121 Function not allowed due to <detailed reason>' as specified in subclause 5.6 "*Warning header*" to the originating network. Otherwise, continue with the rest of the steps;
 - c) SHALL check if <max-participant-count> as specified in [OMA-PoC-Documents-Mgmt] is already reached. If reached, PoC Server SHALL return a SIP 486 "Busy Here" response with the warning text set to '102 Too many participants' to the originating network as specified in subclause 5.6 "*Warning header*". Otherwise, continue with the rest of the steps;
 - d) SHALL check if a Resource-Priority header is included in the SIP INVITE request, according to rules and procedures of [RFC4412], if the 'Official Government Use' QoE Profile is supported. If included the PoC Server SHALL:
 - i. check that the QoE Profile attribute contained in the SDP offer indicates 'Official Government Use' QoE Profile, as specified in subclause E.3.2 "*QoE Profile*". If the QoE Profile attribute indicates other QoE Profile, the PoC Server SHALL reject the request with a SIP 403 "Forbidden" response with the warning text set to '114 QoE Assignment Error' as specified in subclause 5.6 "*Warning header*"; and,

- ii. apply any preferential treatment to the SIP request as specified in [RFC4412], skip the next step and proceed with the rest of the steps.
- e) SHALL check for a QoE Profile attribute contained in the request, if QoE Profiles are enabled. If the included QoE Profile is lower, as specified in subsection 5.8 "*QoE Profiles*" than the QoE Profile assigned to the active Dispatch PoC Session and if the QoE Profile assigned to the Active PoC Session is marked as "mandatory", the PoC Server SHALL reject the request with a SIP 403 "Forbidden" response with the warning text set to '114 QoE Assignment Error' as specified in subclause 5.6 "*Warning header*". Otherwise continue with the rest of the steps;
- f) SHALL use the value "dispatch=entire-group" as the Dispatch Type uri-parameter for the Dispatch PoC Session;
- g) SHALL generate a SIP 200 "OK" response as specified in the 7.2.1.1 "*General*";
- h) SHALL include in the SIP 200 "OK" response a MIME SDP body as an SDP answer to the SDP offer in the incoming SIP INVITE request as specified in the subclause 7.2.1.1a "*SDP answer generation*";
- i) SHALL include in the Authenticated Originator's PoC Address and in the Contact header of the SIP 200 "OK" response the Dispatch Type uri-parameter "dispatch=entire-group" as specified in E.5.2 "*Dispatch Type uri-parameter*";

NOTE 4: Resulting User Plane processing is completed before the next step is performed.

- j) SHALL interact with User Plane as specified in [OMA-PoC-UP] "*Controlling PoC Function procedures at PoC Session initialization*";
- k) SHALL send the SIP 200 "OK" response towards the Inviting PoC Client according to rules and procedures of the SIP/IP Core;
- l) SHALL generate a notification to the PoC Clients, which have subscribed to the conference state event package that the Inviting PoC User has joined in the PoC Group Session, as specified in subclause 7.2.1.11.2 "*Generating a SIP NOTIFY request*"; and,
- m) SHALL send the SIP NOTIFY request to the PoC Clients according to rules and procedures of the SIP/IP Core.

Upon receiving a SIP response for the SIP INVITE request, as specified in subclause 7.2.2.2 "*PoC Session invitation requests*", the PoC Server SHALL proceed as specified in subclause 7.2.1.3.1 "*General*".

When the SIP/IP Core corresponds with 3GPP/3GPP2 IMS, the PoC Server SHALL use 3GPP/3GPP2 IMS mechanisms according to rules and procedures of [3GPP TS 24.229] / [3GPP2 X.S0013.4] with the clarifications given in this subclause.

7.2.1.4 Rejoining PoC Session request

Upon receiving a SIP INVITE request that includes a PoC Session Identity in the Request-URI the PoC Server:

- 1. SHALL check whether the Accept-Contact header includes the PoC feature tag '+g.poc.talkburst' and if it is not included the PoC Server SHALL return a SIP 403 "Forbidden" response with the warning text set to '120 Routing error in network' as specified in subclause 5.6 "*Warning header*". Otherwise, continue with the rest of the steps;
- 2. SHALL check the presence of the Session Type uri-parameter in the Request-URI and if it is present check whether it matches with the correct Session Type of the Request-URI and if it does not then the PoC Server SHALL reject the request with a SIP 404 "Not Found" response with the warning text '100 Correct Session Type of <Request-URI> is "session=chat" or '101 Correct Session Type of <Request-URI> is "session=prearranged"' as specified in subclause 5.6 "*Warning header*". Otherwise, continue with the rest of the steps;
- 3. SHALL check whether the Authenticated Originator's PoC Address of the joining PoC User is allowed to join by performing the actions specified in subclause 7.2.1.6 "*PoC Session joining policy*". If it is not allowed to join the PoC Server SHALL respond with a SIP 403 "Forbidden" response with the warning text set to '121 Function not allowed due to <detailed reason>' as specified in subclause 5.6 "*Warning header*" to the originating network. Otherwise, continue with the rest of the steps;
- 4. SHALL check if a Resource-Priority header is included in the SIP INVITE request, according to rules and procedures of [RFC4412], if the 'Official Government Use' QoE Profile is supported. If included the PoC Server SHALL:

- a) check that the QoE Profile attribute contained in the SDP offer indicates 'Official Government Use' QoE Profile, as specified in subclause E.3.2 "*QoE Profile*". If the QoE Profile attribute indicates other QoE Profile, the PoC Server SHALL reject the request with a SIP 403 "Forbidden" response with the warning text set to '114 QoE Assignment Error' as specified in subclause 5.6 "*Warning header*". Otherwise, continue with the rest of the steps;
 - b) apply any preferential treatment to the SIP request as specified in [RFC4412], skip the next step and proceed with the rest of the steps;
- 5. SHALL check for a QoE Profile attribute contained in the SIP request, if QoE Profiles are enabled. If the included QoE Profile is lower, as specified in subsection 5.8 "*QoE Profiles*" than the QoE Profile assigned to the Active PoC Session, and if the QoE Profile assigned to the Active PoC Session is marked as "mandatory", the PoC Server SHALL reject the request with a SIP 403 "Forbidden" response with the warning text set to '114 QoE Assignment Error' as specified in subclause 5.6 "*Warning header*". Otherwise continue with the rest of the steps;
- 6. SHALL in the case a Chat or Pre-arranged PoC Group Session check if <max-participant-count> as specified in [OMA-PoC-Document-Mgmt] is already reached. If reached,
 - a) If the PoC Server supports Official Government Use QoE Profile, and if the incoming invitation requests an 'Official Government Use' Local QoE Profile with an associated PoC Session Precedence that is higher than the PoC Session Precedence associated to the Local QoE Profile of at least one of the participants of the PoC Session, then according to Service Provider Policy the PoC Server MAY release a participant of lowest Local QoE Profile as specified in subclause 7.2.2.4 "*Removal of Participant from PoC Session*", and skip the next step;
 - b) PoC Server SHALL return a SIP 486 "Busy Here" response with the warning text set to '102 Too many participants' to the originating network as specified in subclause 5.6 "*Warning header*". Otherwise, continue with the rest of the steps;
- 7. SHALL check whether privacy is allowed for the Authenticated Originator's PoC Address, when anonymity is requested with the Privacy header containing the tag 'id' If not allowed, the PoC Server SHALL respond with a SIP 403 "Forbidden" response with the warning text set to '119 Anonymity not allowed' as specified in subclause 5.6 "*Warning header*" to the originating network. Allowing privacy for a specific Authenticated Originator's PoC Address is defined using <allow-anonymity> element of the PoC Group's authorization rules as specified in [OMA-PoC-Document-Mgmt]. If privacy is allowed, the PoC Server SHALL create and cache an Anonymous PoC Address as specified in subclause 5.9 "*Anonymous PoC Address*" and a Nick Name as specified in subclause 5.4 "*Nick Name*". Otherwise, continue with the rest of the steps;

NOTE 1: The Anonymous PoC Address is an alias for the PoC User, and this address appears in Participant Information and the User Plane Taken message. This alias PoC Address is used when expelling the PoC Participant from the PoC Session.

- 8. SHALL validate that the received SDP offer includes at least one Media Stream used in the PoC Session with the Media-floor Control binding as used in the PoC Session for which the Media Parameters and at least one codec or Media format is acceptable for the PoC Server and if not, reject the request with a SIP 488 "Not Acceptable Here" response generated as specified in the subclause 7.2.1.1 "*General*". Otherwise, continue with the rest of the steps;
- 9. SHALL check whether the Contact header of the incoming SIP INVITE request includes the PoC Dispatcher feature tag '+g.poc.dispatcher', in case of a Dispatch PoC Session. If it is present and the joining PoC User is not the Active PoC Dispatcher for the Dispatch PoC Session, the PoC Server SHALL reject the request with as SIP 486 "Busy Here" response with the warning text set to '110 Dispatch group has already another active dispatcher' as specified in subclause 5.6 "*Warning header*". Otherwise, continue with the rest of the steps;
- 10. SHOULD use the "b=AS" attribute as specified in [OMA-PoC-UP] "*Media Buffering*", if included in the SDP offer;
- 11. SHALL accept the SIP request and generate a SIP 200 "OK" response to the SIP request as specified in the subclause 7.2.1.1 "*General*";
- 12. SHALL include a MIME SDP body as an SDP answer to the SDP offer in the incoming SIP INVITE request as specified in the subclause 7.2.1.1.a "*SDP answer generation*";
- 13. SHALL include in the Authenticated Originator's PoC Address and in the Contact header of the SIP 200 "OK" response the Dispatch Type uri-parameter "dispatch=entire-group", or "dispatch=sub-group" as appropriate for the

type of the Dispatch PoC Session, as specified in E.5.2 "*Dispatch Type uri-parameter*", in case of a Dispatch PoC Session.

- 14. SHALL interact with the User Plane as specified in [OMA-PoC- UP] "*Controlling PoC Function procedures at PoC Session initialization*";

NOTE 2: Resulting User Plane processing is completed before the next step is performed.

- 15. SHALL send the SIP 200 "OK" response towards the PoC Client according to rules and procedures of SIP/IP Core;
- 16. SHALL generate a notification to the PoC Clients, which have subscribed to the conference state event package that a PoC User has joined in the PoC Group Session, as specified in subclause 7.2.1.11.2 "*Generating a SIP NOTIFY request*"; and,
- 17. SHALL send the SIP NOTIFY request to the PoC Clients according to rules and procedures of the SIP/IP Core.

When the SIP/IP Core corresponds with 3GPP/3GPP2 IMS, the PoC Server SHALL use 3GPP/3GPP2 IMS Session establishment mechanisms according to rules and procedures of [3GPP TS 24.229] / [3GPP2 X.S0013.4] with the clarifications given in this subclause.

7.2.1.5 Joining Chat PoC Group Session request

Upon receiving a SIP INVITE request that includes a PoC Group Identity, which identifies the Chat PoC Group in the request URI that is owned by the PoC Server, the PoC Server:

- 1. MAY reject the SIP INVITE request with a SIP 503 "Service Unavailable" response depending on the value of the requested QoE Profile if QoE Profiles are enabled, the Chat PoC Group Session does not already exist and a risk of congestion exists as specified in [OMA-PoC-UP] "*Procedures at the PoC Server performing the Controlling PoC Function*". The PoC Server MAY include a Retry-After header to the 503 "Service Unavailable" response as specified in [RFC3261];

NOTE 1: The PoC Client is allowed to re-attempt the PoC Session establishment after the time defined by the Retry-After header.

- 2. SHALL check whether the Accept-Contact header includes the PoC feature tag '+g.poc.talkburst' and if it is not included the PoC Server SHALL reject the request with a SIP 403 "Forbidden" response with the warning text set to '120 Routing error in network' as specified in subclause 5.6 "*Warning header*". Otherwise, continue with the rest of the steps;
- 3. SHALL check the presence of the 'isfocus' feature parameter in the URI of the Contact header and if it is present then the PoC Server SHALL reject the request with a SIP 403 "Forbidden" response with the warning text set to '105 Isfocus already assigned' as specified in subclause 5.6 "*Warning header*". Otherwise, continue with the rest of the steps;
- 4. SHALL check whether the Authenticated Originator's PoC Address of the joining PoC User is allowed to join by performing the actions specified in subclause 7.2.1.6 "*PoC Session joining policy*". If it is not allowed to join the PoC Server SHALL reject the request with a SIP 403 "Forbidden" response with the warning text set to '121 Function not allowed due to <detailed reason>' as specified in subclause 5.6 "*Warning header*" to the originating network. Otherwise, continue with the rest of the steps;
- 5. SHALL check whether privacy is allowed for the Authenticated Originator's PoC Address, when anonymity is requested with the Privacy header containing the tag 'id'. If not allowed, the PoC Server SHALL respond with a SIP 403 "Forbidden" response with the warning text set to '119 Anonymity not allowed' as specified in subclause 5.6 "*Warning header*" to the originating network. Allowing privacy for a specific Authenticated Originator's PoC Address is defined using <allow-anonymity> element of the PoC Group's authorization rules as specified in [OMA-PoC-Document-Mgmt]. If privacy is allowed, the PoC Server SHALL create and cache an Anonymous PoC Address as specified in subclause 5.9 "*Anonymous PoC Address*" and a Nick Name as specified in subclause 5.4 "*Nick Name*". Otherwise, continue with the rest of the steps;

NOTE 2: The Anonymous PoC Address is an alias for the PoC User, and this address appears in Participant Information and the User Plane Taken message. This alias PoC Address is used when expelling the PoC Participant from the PoC Session.

- 6. SHALL validate that the received SDP offer includes at least one Media Stream for which the Media Parameters and at least one codec or Media format is acceptable for the PoC Server and the Media Type is either used in the PoC Session or allowed by adding Media policy as specified in subclause 7.2.1.21 "*Policy for allowing Media Streams in a PoC Session*" and if not, reject the request with a SIP 488 "Not Acceptable Here" response generated as specified in the subclause 7.2.1.1 "*General*". Otherwise, continue with the rest of the steps;
- 7. SHOULD use the "b=AS" attribute as specified in [OMA-PoC-UP] "*Media Buffering*", if included in the SDP offer;
- 8. If the Chat PoC Group Session does not already exist, the PoC Server:
 - a) SHALL check if a Resource-Priority header is included in the SIP INVITE request, according to rules and procedures of [RFC4412], if the 'Official Government Use' QoE Profile is supported. If included the PoC Server SHALL:
 - i. check that the QoE Profile attribute contained in the SDP offer indicates 'Official Government Use' QoE Profile, as specified in subclause E.3.2 "*QoE Profile*". If the QoE Profile attribute indicates other QoE Profile, the PoC Server SHALL reject the request with a SIP 403 "Forbidden" response with the warning text set to '114 QoE Assignment Error' as specified in subclause 5.6 "*Warning header*". ;
 - ii. assign 'Official Government Use' QoE Profile as the QoE Profile for the PoC Session; and,
 - iii. apply any preferential treatment to the SIP request as specified in [RFC4412], skip the next step and proceed with the rest of the steps.
 - b) If QoE Profiles are enabled, the PoC Server SHALL:
 - i. if there is no <qoe> element defined in the PoC Group document as specified in [OMA-PoC-Documents-Mgmt], assign the QoE Profile indicated in the QoE Profile attribute in the SDP offer as the QoE Profile of the PoC Session.
 - ii. if there is a <qoe> element defined in the PoC Group document as specified in [OMA-PoC-Documents-Mgmt], check whether the value of the QoE Profile attribute in the SDP offer is equal or higher, as specified in 5.8 "*QoE Profiles*", than the value of the <qoe> element. If it is lower the PoC Server SHALL reject the SIP INVITE request with a SIP 403 "Forbidden" response with the warning text set to '114 QoE Assignment Error' as specified in subclause 5.6 "*Warning header*". Otherwise, the PoC Server SHALL assign the value of the <qoe> element as the QoE Profile of the PoC Session and SHALL mark it as "mandatory" and continue with the rest of the steps,

NOTE 3: If no QoE Profile attribute is included in the SDP offer of the SIP INVITE request, it is considered that 'Basic' QoE Profile is requested.

- c) SHALL create a Chat PoC Group Session.
- 9. If the Chat PoC Group Session already exists, the PoC Server:
 - a). SHALL check if a Resource-Priority header is included in the SIP INVITE request, according to rules and procedures of [RFC4412], if the 'Official Government Use' QoE Profile is supported. If included the PoC Server SHALL:
 - i. check that the QoE Profile attribute contained in the SDP offer indicates 'Official Government Use' QoE Profile, as specified in subclause E.3.2 "*QoE Profile*". If the QoE Profile attribute indicates other QoE Profile, the PoC Server SHALL reject the request with a SIP 403 "Forbidden" response with the warning text set to '114 QoE Assignment Error' as specified in subclause 5.6 "*Warning header*"; and,
 - ii. apply any preferential treatment to the SIP request as specified in [RFC4412], skip the next step and proceed with the rest of the steps.
 - b) SHALL check the QoE Profile attribute contained in the request, if QoE Profiles are enabled. If the included QoE Profile is lower, as specified in subclause 5.8 "*QoE Profiles*" than the QoE Profile assigned to the Active PoC Session and if the QoE Profile assigned to the Active PoC Session is marked as "mandatory", the PoC Server SHALL reject the request with a SIP 403 "Forbidden" response with the warning text set to '114 QoE Assignment Error' as specified in subclause 5.6 "*Warning header*". Otherwise, continue with the rest of the steps and,
 - c) SHALL check if <max-participant-count> as specified in [OMA-PoC-Documents-Mgmt] is already reached. If reached:

- i. If the PoC Server supports 'Official Government Use' QoE Profile, and if the incoming invitation requests an 'Official Government Use' Local QoE Profile with an associated PoC Session Precedence that is higher than the PoC Session Precedence associated to the Local QoE Profile of at least one of the participants of the PoC Session, then according to Service Provider Policy the PoC Server MAY release a participant of lowest Local QoE Profile as specified in subclause 7.2.2.4 "*Removal of Participant from PoC Session*", and skip the next step; and,
 - ii. The PoC Server SHALL return SIP 486 "Busy Here" response with the warning text set to '102 Too many participants' to the originating network as specified in subclause 5.6 "*Warning header*". Otherwise, continue with the rest of the steps.
- 10. SHALL accept the SIP request and generate a SIP 200 "OK" response to the SIP INVITE request as specified in the subclause 7.2.1.1 "*General*";
- 11 SHALL include in the SIP 200 "OK" response a MIME SDP body as an SDP answer to the SDP offer in the incoming SIP INVITE request as specified in the subclause 7.2.1.1a "*SDP answer generation*";
- 12. SHALL interact with the User Plane as specified in [OMA-PoC-UP] "*Controlling PoC Function procedures at PoC Session initialization*";

NOTE 4: Resulting User Plane processing is completed before the next step is performed.

- 13. SHALL send the SIP 200 "OK" response towards the PoC Client according to rules and procedures of SIP/IP Core;
- 14. SHOULD start PoC Session modification with the PoC Client as specified in subclause 7.2.2.5 "*PoC Session modification*", if a Media not offered in the received SDP offer is used in the PoC Session and if the PoC Session already existed before;
- 15. SHOULD start PoC Session modification with the other PoC Clients as specified in subclause 7.2.2.5 "*PoC Session modification*", if there is a Media Type in the received SDP offer which was not used in the PoC Session and which is allowed by adding Media policy as specified in subclause 7.2.1.21 "*Policy for allowing Media Streams in a PoC Session*" and which was not offered to the other PoC Client yet;
- 16. SHALL send a notification to the PoC Clients, which have subscribed to the conference state event package that a PoC User has joined in the Chat PoC Group Session, as specified in subclause 7.2.1.11.2 "*Generating a SIP NOTIFY request*"; and,
- 17. SHALL send the SIP NOTIFY request to the PoC Clients according to rules and procedures of the SIP/IP Core.

When the SIP/IP Core corresponds with 3GPP/3GPP2 IMS, the PoC Server SHALL use 3GPP/3GPP2 IMS Session establishment mechanisms according to rules and procedures of [3GPP TS 24.229] / [3GPP2 X.S0013.4] with the clarifications given in this subclause.

7.2.1.6 PoC Session joining policy

The PoC Server performing the Controlling PoC Function SHALL allow only those PoC Users to join in the Ad-hoc and 1-1 PoC Session that it hosts who:

- 1. Have been invited in the original invitation; and,
- 2. Have been invited during the PoC Session by the owner or by another Participant of the PoC Session.

The PoC Server performing the Controlling PoC Function SHALL allow only those PoC Users to join in the Pre-arranged or Chat PoC Group Session that it hosts whose Authenticated Originator's PoC Address is allowed by the <join-handling> action of the PoC Group's authorization rules, and the <supported-services> element, if present, indicates the support for PoC service as specified in [OMA-PoC-Document-Mgmt].

NOTE: A Pre-arranged PoC Group or a Chat PoC Group of type Restricted Group has the additional condition that the PoC User is a member of <list> element for allowing the PoC User to join the PoC Session.

7.2.1.7 PoC Session modification

The PoC Session modification can be made due to changing codecs and Media Parameters of Media Streams, changing the Media formats of supported Media Streams, adding new Media Streams to a PoC Session, disconnecting from a Media

Stream, connecting to a Media Stream or changing bindings between Media Streams and Media-floor Control Entities or combination of these.

Upon receiving a SIP UPDATE request or a SIP re-INVITE request within an existing PoC Session including a new SDP offer as specified by [RFC3264] and [RFC4566] the PoC Server:

- 1. SHALL validate that the received SDP offer includes at least one Media Stream for which the Media Parameters and at least one codec or Media format is acceptable by the PoC Server and if not reject the request with a SIP 488 "Not Acceptable Here" response generated as specified in the subclause 7.2.1.1 "General". Otherwise, continue with the rest of the steps;
- 2. SHALL check if a Resource-Priority header for 'Official Government Use' QoE Profile is included in the SIP UPDATE request or SIP re-INVITE request, if the 'Official Government Use' QoE Profile is supported. If included, the PoC Server SHALL apply preferential treatment to the request to modify the PoC Session, as specified in [RFC4412];
- 3. SHALL perform actions to verify the Authenticated Originator's PoC Address and authorize the used and offered Media Streams with the used Media-floor Control Entity binding if not the same as in the received SDP offer as specified in subclause 7.2.1.21 "Policy for allowing Media Streams in a PoC Session" and as specified in 7.2.1.22 "Policy for removing Media from PoC Session" and if not authorized, the PoC Server SHALL return a SIP 488 "Not Acceptable Here" response generated as specified in the subclause 7.2.1.1 "General". Otherwise continue with the rest of the steps;
- 4. SHALL perform actions to verify the Authenticated Originator's PoC Address and authorize the offered Media Stream currently not used in the PoC Session as specified in subclause 7.2.1.21 "Policy for allowing Media Streams in a PoC Session", and if not authorized, the PoC Server SHALL return a SIP 488 "Not Acceptable Here" response generated as specified in the subclause 7.2.1.1 "General". Otherwise continue with the rest of the steps;
- 5. SHALL mark in the SDP offer the offered Media Stream as rejected, if the codecs, Media formats or Media Parameters of the offered Media Stream are not acceptable for the PoC Server;
- 6. SHALL modify according to the received SDP offer the PoC Session towards other Participants as specified in subclause 7.2.2.5 "PoC Session modification",
 - a) if the received SDP offer includes a Media Stream, which is currently not used in a PoC Session;
 - b) if the received SDP offer includes a Media Stream, which is used in a PoC Session and which is marked as rejected and if allowed by the Media Stream removal policy defined in subclause 7.2.1.22 "Removing Media from a PoC Session policy";
 - c) if the current Media-floor Control Entity binding of a Media Stream used and offered by the originating PoC Client is not the same as in the received SDP offer; or,
 - d) any combination of the previous.
- 7. SHALL interact with the User Plane as specified in [OMA-PoC-UP] "Controlling PoC Function procedures when disconnecting from a Media Type" for disconnecting from the Media Stream in the PoC Session for the originating PoC Client, if the Media Stream in the received SDP offer was marked as rejected or if the current Media-floor Control Entity binding of a Media Stream used and offered by the originating PoC Client is not the same as in the received SDP offer;
- 8. SHALL interact with the User Plane as specified in [OMA-PoC-UP] "Controlling PoC Function procedures when adding a Media Type to PoC Session", if the offered Media Stream is currently not used in the PoC Session or if the current Media-floor Control Entity binding of a Media Stream used and offered by the originating PoC Client is not the same as in the received SDP offer;
- 9. SHALL interact with the User Plane as specified in [OMA-PoC-UP] "Controlling PoC Function procedures when connecting to a Media Type" for connecting to the Media Stream in the PoC Session, if the offered Media Stream is currently used in the PoC Session, but not used by the originating PoC Client;
- 10. SHALL interact with the User Plane as specified in [OMA-PoC-UP] "User Plane adaptation" for updating the User Plane with the new codecs, Media formats or Media Parameters for those Media Stream where the offered Media Parameters, Media formats or codecs changed, from those earlier accepted by the PoC Client;
- 11. SHALL generate a SIP 200 "OK" response including a MIME SDP body as an SDP answer as specified in subclause 7.2.1.1a "SDP answer generation";
- 12. SHALL send the SIP 200 "OK" response to the SIP/IP Core along the signalling path;

- 13. SHOULD generate a notification as specified in subclause 7.2.1.11.2 "*Generating a SIP NOTIFY request*" to the PoC Clients, which have subscribed to the conference state event package, if a PoC User has put the PoC Session on hold or off hold or if Media Stream used by the PoC Session modification initiator have changed and the PoC Server performing the Controlling PoC Function includes the information about Media Stream used in the PoC Session to the Participant Information;
- 14. SHOULD send the SIP NOTIFY request to the PoC Clients according to rules and procedures of the SIP/IP Core; and,
- 15. SHALL release the PoC Session as specified in 7.2.2.4 "*Removal of Participant from a PoC Session*" if the criteria for releasing the PoC Session as specified in 7.2.1.16 "*PoC Session release policy*" is fulfilled and if a Media Type or a Media-floor Control entity is removed from the PoC Session..

NOTE: The PoC Server may determine to update the Media Parameters and codec(s) of the other Participants according to the local policy. The modification is specified in subclause 7.2.2.5 "*PoC Session modification*".

When the SIP/IP Core corresponds with 3GPP/3GPP2 IMS, the PoC Server SHALL use 3GPP/3GPP2 IMS mechanisms according to rules and procedures of [3GPP TS 24.229] / [3GPP2 X.S0013.4] with the clarifications given in this subclause.

7.2.1.8 Adding Participants to PoC Session request

Upon receiving a SIP REFER request that is without a method parameter in the Refer-To header or when the method parameter is set to "INVITE" in the Refer-To header, the PoC Server:

- 1. SHALL perform actions to verify the Authenticated Originator's PoC Address of the Inviting PoC User and authorize the request as specified in subclauses 7.2.1.14 "*PoC Session initiation policy*" and 7.2.1.15 "*PoC Session adding policy*" and if it is not authorized the PoC Server SHALL return a SIP 403 "Forbidden" response with the warning text set to '121 Function not allowed due to <detailed reason>' as specified in subclause 5.6 "*Warning header*". Otherwise, continue with the rest of the steps;
- 2. SHALL check whether privacy is allowed for the Authenticated Originator's PoC Address, if anonymity is requested via a Privacy header containing the tag 'id' in the SIP REFER request, if adding PoC User(s) to a Pre-arranged PoC Group or Chat PoC Group Session. If not allowed, the PoC Server SHALL respond with a SIP 403 "Forbidden" response with the warning text set to '119 Anonymity not allowed' as specified in subclause 5.6 "*Warning header*" to the originating network. Allowing privacy for a specific Authenticated Originator's PoC Address is defined using <allow-anonymity> element of the PoC Group's authorization rules as specified in [OMA-PoC-Document-Mgmt]. If privacy is allowed, the PoC Server SHALL create and cache an Anonymous PoC Address as specified in subclause 5.9 "*Anonymous PoC Address*" and a Nick Name as specified in subclause 5.4 "*Nick Name*". Otherwise, continue with the rest of the steps;

NOTE 1: The Anonymous PoC Address is an alias for the PoC User, and this address appears in Participant Information and the User Plane Taken message. This alias PoC Address is used when expelling the PoC Participant from the PoC Session.

- 3. SHALL check if a Resource-Priority header for 'Official Government Use' QoE Profile is included in the SIP REFER request, if the 'Official Government Use' QoE Profile is supported. If included, the PoC Server SHALL apply preferential treatment to the request to add Participants to the PoC Session, as specified in [RFC4412];
- 4. SHALL extract the PoC Address(es) of the PoC User(s) from the SIP REFER request to be invited either:
 - a) from the Refer-To header according to rules and procedures of [RFC3515]; or,
 - b) from the MIME resource-lists body according to rules and procedures of [draft-multiple-refer];
- 5. SHALL check whether the PoC User(s) to be added, in addition to those already participating, do not exceed the maximum number of Participants allowed in an Ad-hoc PoC Group Session, if adding PoC User(s) to an Ad-hoc PoC Group Session. If exceeded, according to the local policy, the PoC Server SHALL return a SIP 486 "Busy Here" response with the warning text set to '102 Too many participants' to the originating network as specified in subclause 5.6 "*Warning header*". Otherwise, continue with the rest of the steps;
- 6. SHALL check whether the PoC User(s) to be added, in addition to those already participating, do not exceed the maximum number of Participants allowed in the PoC Group Session according to the <max-participant-count> element, which is specified in [OMA-PoC-Document-Mgmt], if adding PoC Users to a Chat or Pre-arranged PoC Group Session. If exceeded, the PoC Server SHALL return a SIP 486 "Busy Here" response with the warning text

set to '102 Too many participants' to the originating network as specified in subclause 5.6 "Warning header". Otherwise, continue with the rest of the steps.

- 7. SHALL generate a SIP 2xx final response to the SIP REFER request according to rules and procedures of [RFC3515];
- 8. SHALL if the SIP REFER request was an initial SIP request received outside of an existing dialog, then the PoC Server SHALL include in the response to the SIP REFER request a Supported header with the option tag 'norefersub' according to rules and procedures of [RFC4488];
- 9. SHALL check the presence of the Refer-Sub header of the SIP REFER request and if it is present and it has the value 'false' then the PoC Server SHALL include in the response to the SIP REFER request a Refer-Sub header set to 'false' according to rules and procedures of [RFC4488];
- 10. SHALL send the SIP 2xx final response to the SIP REFER request towards the PoC Client according to rules and procedures of the SIP/IP Core;
- 11. SHALL perform for the PoC Addresses allowed according to 7.2.1.15 "PoC Session adding policy" the actions described in subclause 7.2.2.2 "PoC Session invitation request" for each URI in the list; and,
- 12. SHALL generate and send to the PoC Client SIP NOTIFY request(s) as specified in the subclause 7.2.1.17 "Generating a SIP NOTIFY request to the SIP REFER request" based on the progress of each SIP INVITE request sent to PoC User(s) in accordance with sub-clause 7.2.2.2 "PoC Session invitation request", if the Refer-Sub header is not present or is set to 'true' in the SIP REFER request.

NOTE 2: A SIP REFER request according to rules and procedures of [RFC3515] or [draft-multiple-refer] is an implicit subscription to event 'refer' if the Refer-Sub header is not present or is set to 'true'.

Upon receiving a SIP 403 "Forbidden" response with the warning code 399 and the warning text '105 Isfocus already assigned', or a SIP 503 "Service Unavailable" response, or a SIP 486 "Busy Here" response, or a SIP 488 "Not Acceptable Here" response, or a SIP 417 "Unknown Resource Priority" response, the PoC Server SHALL if the Refer-Sub header is not present or is set to 'true' in the SIP REFER request, generate and send to the PoC Client a SIP NOTIFY request as specified in the subclause 7.2.1.17 "Generating a SIP NOTIFY request to the SIP REFER request".

Upon receiving SIP provisional responses or SIP final responses for the SIP INVITE request(s) containing a P-Answer-State header with the value "Unconfirmed" as specified in [RFC4964] and as specified in subclause 7.2.2.2 "PoC Session invitation request" the PoC Server:

- 1. SHALL discard the received SIP responses without forwarding them.

When the SIP/IP Core corresponds with 3GPP/3GPP2 IMS, the PoC Server SHALL use 3GPP/3GPP2 IMS mechanisms according to rules and procedures of [3GPP TS 24.229] / [3GPP2 X.S0013.4] with the clarifications given in this subclause.

7.2.1.9 Leaving PoC Session request

7.2.1.9.1 SIP BYE request received in a PoC Session

Upon receiving a SIP BYE request the PoC Server:

- 1. SHALL check if a Resource-Priority header for 'Official Government Use' QoE Profile is included in the SIP BYE request, if the 'Official Government Use' QoE Profile is supported. If included, the PoC Server SHALL apply preferential treatment to the request to leave the PoC Session, as specified in [RFC4412];
- 2. SHALL interact with the User Plane as specified in [OMA-PoC-UP] "Controlling PoC Function Procedures at PoC Session release" for releasing User Plane resource associated with the SIP Session towards the Participating PoC Function;
- 3. SHALL send a SIP 200 "OK" response towards the PoC Client according to rules and procedures of the SIP/IP Core;
- 4. SHALL check PoC Session release policy as specified in the subclause 7.2.1.16 "PoC Session release policy" and according to the applied release policy perform for each Participant of the PoC Session the procedures as specified in the subclause 7.2.2.4 "Remove of Participant from the PoC Session", if needed;
- 5. MAY start PoC Session modification with the other PoC Clients as specified in subclause 7.2.2.5 "PoC Session modification", if there is a Media Type and Media-floor Control Entity which is used by no more than one PoC

Client and allowed by removing Media policy as specified in the subclause 7.2.1.22 "*Removing Media Streams from a PoC Session policy*;

- 6. SHALL generate a notification to the PoC Clients, which have subscribed to the conference state event package that a PoC User has left the PoC Group Session, as specified in subclause 7.2.1.11.2 "*Generating a SIP NOTIFY request*"; and,
- 7. SHALL send the SIP NOTIFY request to the PoC Clients according to rules and procedures of the SIP/IP Core.

When the SIP/IP Core corresponds with 3GPP/3GPP2 IMS, the PoC Server SHALL use 3GPP/3GPP2 IMS mechanisms according to rules and procedures of [3GPP TS 24.229] / [3GPP2 X.S0013.4] with the clarifications given in this subclause.

7.2.1.9.2 SIP REFER BYE request received when using a Pre-established Session

Upon receiving from the PoC Client a SIP REFER request when using a Pre-established Session with the method parameter set to value "BYE" in the Refer-To header the PoC Server:

- 1. SHOULD check if a Resource-Priority header for 'Official Government Use' QoE Profile is included in the SIP REFER request, if the 'Official Government Use' QoE Profile is supported. If included, the PoC Server SHALL apply preferential treatment to the request to leave the PoC Session, as specified in [RFC4412];
- 2. SHALL perform actions to verify the Authenticated Originator's PoC Address of the PoC Client and authorize the request according to local policy and if it is not authorized the PoC Server SHALL return a SIP 403 "Forbidden" response with the warning text set to '121 Function not allowed due to <detailed reason>' as specified in subclause 5.6 "*Warning header*". Otherwise, continue with the rest of the steps;
- 3. SHALL examine the URI in the Refer-To header of the SIP REFER request and
 - a) if the URI is a PoC Address, that identifies a Participant in the on-going PoC Session, the PoC Server :
 - i. SHALL generate a SIP 2xx final response to the SIP REFER request according to rules and procedures of [RFC3515];
 - ii. SHALL include in the response to the SIP REFER request a Supported header with the option tag 'norefersub' according to rules and procedures of [RFC4488], if the SIP REFER request was an initial SIP request received outside of an existing dialog;
 - iii. SHALL check the presence of the Refer-Sub header of the SIP REFER request and if it is present and it has the value 'false' then the PoC Server SHALL include in the response to the SIP REFER request a Refer-Sub header set to 'false' according to rules and procedures of [RFC4488];
 - iv. SHALL send the SIP response to the SIP REFER request towards the PoC Client according to rules and procedures of the SIP/IP Core;
 - v. SHALL check the PoC Session expulsion policy as specified in 7.2.1.27 "*PoC Session expulsion policy*" and according to the applied expulsion policy perform for the identified Participant the procedures specified in subclause 7.2.2.4 "*Removal of Participant from the PoC Session*";
 - vi. SHALL check the PoC Session release policy specified in subclause 7.2.1.16 "*PoC Session release policy*" and according to the applied release policy perform for each identified PoC User the procedures specified in subclause 7.2.2.4 "*Removal of Participant from the PoC Session*", if needed;
 - vii. SHALL generate a notification of the current state of the PoC Session to the PoC Client(s), which have subscribed to the conference state event package, as specified in subclause 7.2.1.11.2 "*Generating a SIP NOTIFY request*";
 - viii. SHALL check the subscription termination policy as specified in subclause 7.2.1.11.3 "*Termination of subscription*" and for each PoC Client terminate the existing subscription to the conference state event package, if needed; and,
 - ix. SHALL send the SIP NOTIFY request to the PoC Client(s) according to rules and procedures of the SIP/IP Core.
 - b) if the URI refers to a URI list, the PoC Server :

- i. SHALL generate a SIP 2xx final response to the SIP REFER request according to rules and procedures of [RFC3515];
 - ii. SHALL include in the response to the SIP REFER request a Supported header with the option tag 'norefersub' according to rules and procedures of [RFC4488], if the SIP REFER request was an initial SIP request received outside of an existing dialog;
 - iii. SHALL check the presence of the Refer-Sub header of the SIP REFER request and if it is present and it has the value 'false' then the PoC Server SHALL include in the response to the SIP REFER request a Refer-Sub header set to 'false' according to rules and procedures of [RFC4488];
 - iv. SHALL send the SIP response to the SIP REFER request towards the PoC Client according to rules and procedures of the SIP/IP Core;
 - v. SHALL check the PoC Session expulsion policy as specified in 7.2.1.27 "*PoC Session expulsion policy*" and according to the applied expulsion policy perform for each identified Participant the procedures specified in subclause 7.2.2.4 "*Removal of Participant from the PoC Session*";
 - vi. SHALL check the PoC Session release policy specified in subclause 7.2.1.16 "*PoC Session release policy*" and according to the applied release policy perform for each identified PoC User the procedures specified in subclause 7.2.2.4 "*Removal of Participant from the PoC Session*", if needed;
 - vii. SHALL generate a notification of the current state of the PoC Session to the PoC Client(s), which have subscribed to the conference state event package, as specified in subclause 7.2.1.11.2 "*Generating a SIP NOTIFY request*";
 - viii. SHALL check the subscription termination policy as specified in subclause 7.2.1.11.3 "*Termination of subscription*" and for each PoC Client terminate the existing subscription to the conference state event package, if needed; and,
 - ix. SHALL send the SIP NOTIFY request to the PoC Client(s) according to rules and procedure of the SIP/IP Core.
- c) if the URI is the PoC Session Identity of the on-going PoC Session then the PoC Server :
- i. SHALL generate a SIP 2xx final response to the SIP REFER request according to rules and procedures of [RFC3515];
 - ii. SHALL include in the response to the SIP REFER request a Supported header with the option tag 'norefersub' according to rules and procedures of [RFC4488], if the SIP REFER request was an initial SIP request received outside of an existing dialog;
 - iii. SHALL check the presence of the Refer-Sub header of the SIP REFER request and if it is present and it has the value 'false' then the PoC Server SHALL include in the response to the SIP REFER request a Refer-Sub header set to 'false' according to rules and procedures of [RFC4488];
 - iv. SHALL send the SIP response to the SIP REFER request towards the PoC Client according to rules and procedures of the SIP/IP Core;
 - v. SHALL check the PoC Session release policy specified in subclause 7.2.1.16 "*PoC Session release policy*" and according to the applied release policy perform either:
 - A. for each identified PoC User: the procedures specified in subclause 7.2.2.4 "*Removal of Participant from the PoC Session*"; or,
 - B. remove the Participant referred by the Authenticated Originator's PoC Address from the PoC Session by performing the procedures as specified in subclause 7.2.2.4 "*Removal of Participant from the PoC Session*".

- vi. SHALL generate a notification of the current state of the PoC Session to the PoC Client(s), which have subscribed to the conference state event package, as specified in subclause 7.2.1.11.2 *"Generating a SIP NOTIFY request"*;
 - vii. SHALL check the subscription termination policy as specified in subclause 7.2.1.11.3 *"Termination of subscription"* and for each PoC Client terminate the existing subscription to the conference state event package, if needed; and,
 - viii. SHALL send the SIP NOTIFY request to the PoC Client(s) according to rules and procedures of the SIP/IP Core.
- d) if the URI is not a PoC Address and does not refer to a URI list and is not the PoC Session Identity of the on-going PoC Session, the PoC Server:
- i. SHALL return SIP 404 "Not Found" response. Otherwise continue with the rest of the steps.
- 4. SHALL generate and send to the PoC Client SIP NOTIFY request(s) as specified in subclause 7.2.1.17 *"Generating a SIP NOTIFY request to the SIP REFER request"* based on the progress of the SIP BYE request, if the Refer-Sub header is not present or is set to 'true' in the SIP REFER request.

NOTE: A SIP REFER request according to rules and procedures of [RFC3515] or [draft-multiple-refer] is an implicit subscription to event 'refer' in case the Refer-Sub header is not present in or is set to 'true'.

When the SIP/IP Core corresponds with 3GPP/3GPP2 IMS, the PoC Server SHALL use 3GPP/3GPP2 IMS mechanisms according to rules and procedures of [3GPP TS 24.229] / [3GPP2 X.S0013.4] with the clarifications given in this subclause.

7.2.1.9.3 SIP BYE request received within a Pre-established Session

Upon receiving a SIP BYE request to a Pre-established Session the PoC Server:

- 1. SHOULD check if a Resource-Priority header for 'Official Government Use' QoE Profile is included in the SIP BYE request, if the 'Official Government Use' QoE Profile is supported. If included, the PoC Server SHALL apply preferential treatment to the request to leave the PoC Session, as specified in [RFC4412];
- 2. SHALL check the PoC Session release policy as specified in subclause 7.2.1.16 *"PoC Session release policy"* and perform according to the applied PoC Session release policy for every Participant of the PoC Session (except for the owner of the Pre-established Session) the procedures as specified in subclause 7.2.2.4 *"Remove of Participant from the PoC Session"*;
- 3. SHALL remove the owner from the PoC Session by performing the procedures as specified in subclause 7.3.2.6.3 *"Leaving a PoC Session when using Pre-established Session"*;
- 4. SHALL generate a notification of the current state of the PoC Session to the PoC Client(s), which have subscribed to the conference state event package, as specified in subclause 7.2.1.11.2 *"Generating a SIP NOTIFY request"*;
- 5. SHALL check the subscription termination policy as specified in subclause 7.2.1.11.3 *"Termination of subscription"* and for all PoC Clients terminate the existing subscription to the conference state event package, if needed; and,
- 6. SHALL send the SIP NOTIFY request to the PoC Client according to rules and procedures of the SIP/IP Core.

When the SIP/IP Core corresponds with 3GPP/3GPP2 IMS, the PoC Server SHALL use 3GPP/3GPP2 IMS mechanisms according to rules and procedures of [3GPP TS 24.229] / [3GPP2 X.S0013.4] with the clarifications given in this subclause.

7.2.1.9.4 SIP REFER BYE request received when using an On-demand Session

Upon receiving from the PoC Client a SIP REFER request when using an On-demand Session with the method parameter set to value "BYE" in the Refer-To header the PoC Server:

- 1. SHOULD check if a Resource-Priority header for 'Official Government Use' QoE Profile is included in the SIP REFER request, if the 'Official Government Use' QoE Profile is supported. If included, the PoC Server SHALL apply preferential treatment to the request to leave the PoC Session, as specified in [RFC4412];
- 2. SHALL perform the actions to verify the Authenticated Originator's PoC Address of the PoC Client and authorize the request according to local policy and if not authorized the PoC Server SHALL return a SIP 403 "Forbidden"

response with the warning text set to '121 Function not allowed due to <detailed reason>' as specified in subclause 5.6 "Warning header". Otherwise, continue with the rest of the steps;

- 3. SHALL examine the URI in the Refer-To header of the SIP REFER request and
 - a) if the URI identifies a Participant in the on-going PoC Session, the PoC Server:
 - i. SHALL generate a SIP 2xx final response to the SIP REFER request according to rules and procedures of [RFC3515];
 - ii. SHALL include in the response to the SIP REFER request a Supported header with the option tag 'norefersub' according to rules and procedures of [RFC4488], if the SIP REFER request was an initial SIP request received outside of an existing dialog;
 - iii. SHALL check the presence of the Refer-Sub header of the SIP REFER request and if it is present and it has the value 'false' then the PoC Server SHALL include in the response to the SIP REFER request a Refer-Sub header set to 'false' according to rules and procedures of [RFC4488];
 - iv. SHALL send the SIP 2xx response to the SIP REFER request towards the PoC Client according to rules and procedures of the SIP/IP Core;
 - v. SHALL check the PoC Session expulsion policy as specified in 7.2.1.27 "PoC Session expulsion policy" and according to the applied expulsion policy perform for the identified Participant the procedures specified in subclause 7.2.2.4 "Removal of Participant from the PoC Session";
 - vi. SHALL check the PoC Session release policy specified in subclause 7.2.1.16 "PoC Session release policy" and according to the applied release policy perform for each identified PoC User the procedures specified in subclause 7.2.2.4 "Removal of Participant from the PoC Session", if needed;
 - vii. SHALL generate a notification of the current state of the PoC Session to the PoC Client(s), which have subscribed to the conference state event package, as specified in subclause 7.2.1.11.2 "Generating a SIP NOTIFY request";
 - viii. SHALL check the subscription termination policy as specified in subclause 7.2.1.11.3 "Termination of subscription" and for each PoC Client terminate the existing subscription to the conference state event package, if needed; and,
 - ix. SHALL send the SIP NOTIFY request to the PoC Client(s) according to rules and procedures of the SIP/IP Core.
 - b) if the URI refers to a URI list, then the PoC Server:
 - i. SHALL generate a SIP 2xx final response to the SIP REFER request according to rules and procedures of [RFC3515];
 - ii. SHALL include in the response to the SIP REFER request a Supported header with the option tag 'norefersub' according to rules and procedures of [RFC4488], if the SIP REFER request was an initial SIP request received outside of an existing dialog;
 - iii. SHALL check the presence of the Refer-Sub header of the SIP REFER request and if it is present and it has the value 'false' then the PoC Server SHALL include in the response to the SIP REFER request a Refer-Sub header set to 'false' according to rules and procedures of [RFC4488];
 - iv. SHALL send the SIP 2xx response to the SIP REFER request towards the PoC Client according to rules and procedures of the SIP/IP Core;
 - v. SHALL check the PoC Session expulsion policy as specified in 7.2.1.27 "PoC Session expulsion policy" and according to the applied expulsion policy perform for each identified Participant the procedures specified in subclause 7.2.2.4 "Removal of Participant from the PoC Session";
 - vi. SHALL check the PoC Session release policy specified in subclause 7.2.1.16 "PoC Session release policy" and according to the applied release policy perform for each identified PoC User the procedures specified in subclause 7.2.2.4 "Removal of Participant from the PoC Session", if needed;

- vii. SHALL generate a notification of the current state of the PoC Session to the PoC Client(s), which have subscribed to the conference state event package, as specified in subclause 7.2.1.11.2 "*Generating a SIP NOTIFY request*";
 - viii. SHALL check the subscription termination policy as specified in subclause 7.2.1.11.3 "*Termination of subscription*" and for each PoC Client terminate the existing subscription to the conference state event package, if needed; and,
 - ix. SHALL send the SIP NOTIFY request to the PoC Client(s) according to rules and procedures of the SIP/IP Core.
- c) if the PoC Address is the PoC Session Identity of the on-going PoC Session, then the PoC Server:
- i. SHALL generate a SIP 2xx final response to the SIP REFER request according to rules and procedures of [RFC3515];
 - ii. SHALL include in the response to the SIP REFER request a Supported header with the option tag 'norefersub' according to rules and procedures of [RFC4488], if the SIP REFER request was an initial SIP request received outside of an existing dialog;
 - iii. SHALL check the presence of the Refer-Sub header of the SIP REFER request and if it is present and it has the value 'false' then the PoC Server SHALL include in the response to the SIP REFER request a Refer-Sub header set to 'false' according to rules and procedures of [RFC4488];
 - iv. SHALL send the SIP 2xx response to the SIP REFER request towards the PoC Client according to rules and procedures of the SIP/IP Core;
 - v. SHALL check the PoC Session release policy specified in subclause 7.2.1.16 "*PoC Session release policy*" and according to the applied release policy perform either:
 - A. for each identified PoC User the procedures specified in subclause 7.2.2.4 "*Removal of Participant from the PoC Session*"; or,
 - B. remove the Participant referred by the Authenticated Originator's PoC Address from the PoC Session by performing the procedures as specified in subclause 7.2.2.4 "*Removal of Participant from the PoC Session*".
 - vi. SHALL generate a notification of the current state of the PoC Session to the PoC Client(s), which have subscribed to the conference state event package, as specified in subclause 7.2.1.11.2 "*Generating a SIP NOTIFY request*";
 - vii. SHALL check the subscription termination policy as specified in subclause 7.2.1.11.3 "*Termination of subscription*" and for each PoC Client terminate the existing subscription to the conference state event package, if needed; and,
 - viii. SHALL send the SIP NOTIFY request to the PoC Client(s) according to rules and procedures of the SIP/IP Core.
- d) if the URI is not a PoC Address and does not refer to a URI list and is not the PoC Session Identity of the on-going PoC Session, the PoC Server:
- i. SHALL return SIP 403 "Forbidden" response with the warning text set to '121 Function not allowed due to <detailed reason>' as specified in subclause 5.6 "*Warning header*". Otherwise continue with the rest of the steps.
- 4. SHALL generate and send to the PoC Client a SIP NOTIFY request(s) as specified in subclause 7.2.1.17 "*Generating a SIP NOTIFY request to the SIP REFER request*" based on the progress of the BYE request, if the Refer-Sub header is not present or is set to 'true' in the SIP REFER request.

NOTE: A SIP REFER request according to rules and procedures of [RFC3515] or [draft-multiple-refer] is an implicit subscription to event 'refer' in case the Refer-Sub header is not present in or is set to 'true'.

When the SIP/IP Core corresponds with 3GPP/3GPP2 IMS, the PoC Server SHALL use 3GPP/3GPP2 IMS mechanisms according to rules and procedures of [3GPP TS 24.229] / [3GPP2 X.S0013.4] with the clarifications given in this subclause.

7.2.1.10 Cancel of PoC Session setup request

Upon receiving a SIP CANCEL request, the PoC Server:

- 1. SHALL act as UAS according to rules and procedures of [RFC3261]; and,
- 2. SHALL cancel the PoC Session invitations to the other PoC Clients as specified in subclause 7.2.2.3 "*Cancel of PoC Session invitation request*" or subclause 7.2.2.4 "*Removal of Participant from PoC Session*" depending whether the SIP session has not yet or has already been established in case of Ad-hoc and 1-1 PoC Session establishment and Pre-arranged PoC Group Session establishment.

When the SIP/IP Core corresponds with 3GPP/3GPP2 IMS, the PoC Client SHALL use 3GPP/3GPP2 IMS mechanisms according to rules and procedures of [3GPP TS 24.229] / [3GPP2 X.S0013.4] with the clarifications given in this subclause.

7.2.1.11 PoC Session Participant information request

7.2.1.11.1 Subscribing to Participant information

Upon receiving a SIP SUBSCRIBE request with the Event header set to 'conference' according to rules and procedures of [RFC4575] the PoC Server:

- 1. SHOULD check if a Resource-Priority header requesting the priority treatment of the 'Official Government Use' QoE Profile is included in the SIP SUBSCRIBE request, if the 'Official Government Use' QoE Profile is supported. If included, the PoC Server SHALL apply preferential treatment to the SIP SUBSCRIBE request, as specified in [RFC4412];
- 2. SHALL check whether the PoC Session identified by the PoC Session Identity in the Request-URI is owned by the PoC Server, if the Request-URI contains a PoC Session Identity, and perform the actions specified in subclause 7.5.2 "*Conference URI does not exist*" if it is not owned by the PoC Server; Otherwise continue with the rest of the steps;
- 3. SHALL check whether the PoC Group identified with the PoC Group Identity in the Request-URI is owned by the PoC Server, if the request-URI contains a PoC Group Identity and perform the actions specified in subclause 7.5.2 "*Conference URI does not exist*" if it is not owned by the PoC Server. Otherwise continue with the rest of the steps;
- 4. SHALL perform the actions to verify the Authenticated Originator's PoC Address and authorize the request as specified in subclause 7.2.1.18 "*PoC Session Participant information policy*" and if it is not authorized the PoC Server SHALL return a SIP 403 "Forbidden" response with the warning text set to '121 Function not allowed due to <detailed reason>' as specified in subclause 5.6 "*Warning header*". Otherwise, continue with the rest of the steps;

NOTE: A local policy, e.g. number of simultaneous subscriptions exceeded, may cause the PoC Server to reject the subscription request.

- 5. SHALL create a subscription to the Participant Information of the PoC Session according to rules and procedures of [RFC3265] and [RFC4575];
- 6. SHALL generate a SIP 200 "OK" or a SIP 202 "Accepted" response to the SIP SUBSCRIBE request according to rules and procedures of [RFC3265] and [RFC4575];
- 7. SHALL set the Contact header of the SIP response to the address of the PoC Server;
- 8. SHALL include the Authenticated Originator's PoC Address as specified in subclause 5.2 "*Authenticated Originator's PoC Address*" as follows:
 - a) set to the Conference-factory-URI in case of 1-1 PoC Session or Ad-hoc PoC Group Session; or
 - b) set to the PoC Group Identity of the PoC Group with the Session Type uri-parameter "session=prearranged" or "session=chat" as specified in E.5.1 "*Session Type uri-parameter*" in case of a Pre-arranged or Chat PoC Group respectively.
- 9. SHALL include the option tag 'norefersub' in a Supported header in the SIP response;
- 10. SHALL send the SIP response towards the PoC Client according to rules and procedures of the SIP/IP Core;

- 11. SHALL generate an initial SIP NOTIFY request as specified in subclause 7.2.1.11.2 "*Generating a SIP NOTIFY request*"; and,
- 12. SHALL send the SIP NOTIFY request to the PoC Client according to rules and procedures of the SIP/IP Core.

When a change in the subscribed state occurs, the PoC Server SHOULD generate and send a SIP NOTIFY request as specified in subclause 7.2.1.11.2 "*Generating a SIP NOTIFY request*" and according to rules and procedures of SIP/IP Core respectively.

When needed the PoC Server SHALL terminate the subscription and indicate it to the PoC Client as described in the subclause 7.2.1.11.3 "*Terminating the subscription*".

When the SIP/IP Core corresponds with 3GPP/3GPP2 IMS, the PoC Server SHALL use 3GPP/3GPP2 IMS mechanisms according to rules and procedures of [3GPP TS 24.229] / [3GPP2 X.S0013.4] with the clarifications given in this subclause.

7.2.1.11.2 Generating a SIP NOTIFY request

The PoC Server SHALL generate a SIP NOTIFY request according to rules and procedures of [RFC3265] with the clarifications in this subclause.

The PoC Server SHOULD include in the SIP NOTIFY request a Resource-Priority header, according to rules and procedures of [RFC4412], of the same value as the one included in the SIP SUBSCRIBE request that created the subscription, if that SIP SUBSCRIBE request included a Resource-Priority and if the 'Official Government Use' QoE Profile is supported.

The PoC Server SHOULD limit the rate of SIP NOTIFY requests sent toward a PoC Client.

NOTE 1: How a PoC Server limits the rate of SIP NOTIFY requests towards the PoC Client is out of scope of this specification.

The PoC Server SHOULD avoid sending a SIP NOTIFY request towards a PoC Client at the same time as a Media Burst is sent towards the PoC Client or a Media Burst is received from the PoC Client.

When reporting changes in the Participant information the PoC Server SHALL use partial output according to rules and procedures of [RFC4575].

The PoC Server SHALL include a MIME conference-info+xml body according to rules and procedures of [RFC4575] with the following limitations:

- 1. The PoC Server SHALL include the PoC Group Identity of the PoC Group in the "entity" attribute of the <conference-info> element;
- 2. for each Participant in the PoC Session the PoC Server SHALL include a <user> element. The <user> element:
 - a) SHALL include the "entity" attribute. The "entity" attribute:
 - i. SHALL for the PoC Client, which initiated, joined or re-joined a PoC Session, include the Authenticated Originator's PoC Address of the initial SIP INVITE request, if the Participant has not requested privacy or if the receiver of the SIP NOTIFY request is another PoC Server authorized as specified in subclause 7.2.1.18 "*PoC Session Participant information policy*";
 - ii. SHALL for an Invited PoC Client include the identity used in the URI-list for the Invited PoC Client to an Ad-hoc PoC Group Session or the identity used in the PoC Group definition in case of a Pre-arranged PoC Group Session or restricted Chat PoC Group Session, if the Participant has not requested privacy or if the receiver of the SIP NOTIFY request is another PoC Server authorized as specified in subclause 7.2.1.18 "*PoC Session Participant information policy*"; or,
 - iii. SHALL include the Anonymous PoC Address of the Participant, which has requested privacy unless the receiver of the SIP NOTIFY request is another PoC Server authorized as specified in subclause 7.2.1.18 "*PoC Session Participant information policy*".
 - b) MAY include the <display-text> element. If included, the <display-text> element SHALL include a Nick Name of the identity of the "entity" attribute indicated in a) as collected by the PoC Server performing the Controlling PoC Function according to procedures of subclause 5.4 "*Nick Name*";

c) SHALL include "yourown" attribute with value "true", if the SIP NOTIFY request is to be sent to the PoC Client of the Participant identified by the "entity" attribute of the <user> element, if the Participant requested privacy;

NOTE 2: "yourown" attribute is specified in [OMA-IM-TS_Endorsement] "*Extensions to Conference Event Package XML Schema*" and indicates to the PoC Client which <user> element describes its Participant.

d) SHALL include the "anonymous-id" attribute set to the Anonymous PoC Address of the Participant in accordance with subclause E.1.2 "*Participant information indications*" if the identity in the <user> element is the PoC Address of the Participant and the Participant has requested privacy.

NOTE 3: In order to transfer the Anonymous PoC Addresses (e.g. for detailed billing information) the "anonymous-id" attribute is needed to transfer the Anonymous PoC Address when the Participant has requested privacy and the PoC Server performing the Participant PoC Function has requested the full identity of a Participant.

e) SHALL include a single <endpoint> element. The <endpoint> element

i. SHALL include the "entity" attribute;

ii. SHALL include the <status> element indicating the status of the PoC Session. The <status> element SHOULD have one of the following values:

A. 'connected', when the Participant is added to the PoC Session; or,

B. 'disconnected', when the Participant has left the PoC Session or when the Invited PoC Client is disconnected from the PoC Session before the Invited PoC Client has accepted the invitation and the "alerting" notification has been sent; or,

C. 'on-hold', when the Participant has put the PoC Session on hold; or,

D. 'alerting', when the Invited PoC Client has responded by SIP 180 "Ringing", but not yet accepted the invitation.

iii. The <status> element MAY have the following value:

A. 'dialing-out', when the PoC Server performing the Controlling PoC Function receives the SIP 183 "Session Progress" response in case of Automatic Answer Mode and if a Privacy header is included in the SIP 183 "Session Progress" response.

NOTE 4: The usage of other values of the <status> element is not defined for PoC.

iv. SHALL include the <media> element as specified by [RFC4575] if more than one Media Stream is negotiated in the PoC Session. If included, the <media> element SHALL include negotiated Media Types with the following clarification:

A. SHALL include in the <type> element as specified by [RFC4575]

B. SHALL include the <status> element indicating the sending and receiving status of the Media Stream as specified by [RFC4575].

v. MAY include the "LocalQoE" attribute in accordance with subclause E.1.2 "*Participant information indications*"; and,

vi. MAY include the "FDCFOSupported" attribute in accordance with subclause E.1.2 "*Participant information indications*".

f) MAY include the <roles> element. If included, the <roles> element SHALL include an <entry> element with the value 'dispatcher' when the Participant is the Active PoC Dispatcher in case of a Dispatch PoC Session.

NOTE 5: The usage of other elements specified in [RFC4575] is not defined for PoC.

When the SIP/IP Core corresponds with 3GPP/3GPP2 IMS, the PoC Server SHALL use 3GPP/3GPP2 IMS mechanisms according to rules and procedures of [3GPP TS 24.229] / [3GPP2 X.S0013.4] with the clarifications given in this subclause.

7.2.1.11.3 Terminating the subscription

The PoC Server

- 1. SHALL terminate all subscriptions for Participant information for the PoC Session when the PoC Session is released and not accept any re-subscriptions;
- 2. MAY terminate the subscription for a PoC Client when it leaves the PoC Session;
- 3. for each subscription that shall be terminated the PoC Server:
 - a) SHALL generate a SIP NOTIFY request according to rules and procedures specified in [RFC3265];
 - b) SHALL include a Subscription-State header with the value of 'terminated' and a reason parameter of 'noresource'; and,
 - c) SHALL send the SIP NOTIFY request to the PoC Client according to rules and procedures of SIP/IP Core.

When the SIP/IP Core corresponds with 3GPP/3GPP2 IMS, the PoC Server SHALL use 3GPP/3GPP2 IMS mechanisms according to rules and procedures of [3GPP TS 24.229] / [3GPP2 X.S0013.4] with the clarifications given in this subclause.

7.2.1.12 Group Advertisement request

Upon receiving a SIP MESSAGE request containing the PoC feature tag '+g.poc.groupad' in the Accept-Contact header the PoC Server:

- 1. SHALL reject the SIP MESSAGE request with a SIP 403 "Forbidden" response with the warning text set to '121 Function not allowed due to <detailed reason>' as specified in subclause 5.6 "Warning header", if Group Advertisement is not supported by the PoC Server. Otherwise continue with next step.
- 2. SHALL check whether Request-URI contains a PoC Group Identity or an Exploder-URI identifying a SIP MESSAGE URI-list service according to rules and procedures of [draft-uri-list-message] owned by the PoC Server. If not owned, perform the actions specified in subclause 7.5.2 "Conference URI does not exist". Otherwise, continue with the rest of the steps;
- 3. SHALL perform actions to verify the Authenticated Originator's PoC Address and authorize the request as specified in subclause 7.2.1.20 "Group Advertisement policy" and if it is not authorized the PoC Server SHALL return a SIP 403 "Forbidden" response with the warning text set to '121 Function not allowed due to <detailed reason>' as specified in subclause 5.6 "Warning header". Otherwise, continue with the rest of the steps;
- 4. SHALL return a SIP 403 "Forbidden" response with the warning text set to '119 Anonymity not allowed' as specified in subclause 5.6 "Warning header", if anonymity is requested. Otherwise, continue with the rest of the steps;
- 5. SHALL return a SIP 403 "Forbidden" response with the warning text set to '129 No destinations' as specified in subclause 5.6 "Warning header", if
 - a) the Request-URI identifies a Chat PoC Group other than restricted Chat PoC Group;
 - b) the Request-URI identifies a restricted Chat PoC Group with empty Group List or a Pre-arranged PoC Group with empty Group List; or,
 - c) the Request-URI is an Exploder-URI identifying a SIP MESSAGE URI-list service and XML resource list has no entries.
 Otherwise, continue with the rest of the steps;
- 6. SHALL perform the following actions, if Included Media Content is supported by the PoC Server and if the media content is received in one or more MIME bodies:
 - a) Check if included Media Type is allowed, using a local policy, and if at least one Media Type is not allowed, based on a Service Provider Policy either,
 - i. send a SIP 415 "Unsupported Media Type" response , the SIP 415 "Unsupported Media Type" response SHALL include:
 - 1) the Accept header with the acceptable Media-Types that the PoC Server would accept according to rules and procedures of [RFC3261]; or,

- 2) the Accept-Encoding header with the encoding formats that the PoC Server would accept according to rules and procedures of [RFC3261]; or,
 - 3) both
- and do not continue with the rest of the steps; or,
- ii. remove the MIME bodies containing the not allowed media content.

NOTE 1: One example of a local policy could be that the PoC Server only allows Included Media Content in special traffic scenarios.

- b) Check the total size of all MIME bodies containing media content and if the total size exceeds a configurable max size, based on a Service Provider Policy either,
 - i. send a SIP 413 "Request Entity Too Large" response and do not continue with the rest of the steps; or,
 - ii. remove all MIME bodies containing media content.
- 7. SHALL obtain the PoC Addresses to advertise from the PoC Addresses of the 'uri' attributes of the <entry> elements in the PoC Group document if the Request-URI is a PoC Group Identity identifying a restricted Chat PoC Group or a Pre-arranged PoC Group or from the PoC Addresses of the 'uri' attributes of the <entry> elements in the XML resource list if the Request-URI is an Exploder-URI identifying a SIP MESSAGE URI-list service according to rules and procedures of [draft-uri-list-message];
- 8. MAY remove the Subject header;
- 9. MAY remove the Call-Info header;

NOTE 2: The reason for removing the Subject header and the reason for removing the Call-Info header may be a local policy in the PoC Server.

- 10. SHALL send the SIP MESSAGE request towards each PoC Address as specified in the subclause 7.2.2.6 "Group Advertisement request"; and,
- 11. SHALL send a SIP 202 "Accepted" response along the signalling path towards the initiating PoC Client.

When the SIP/IP Core corresponds with 3GPP/3GPP2 IMS, the PoC Server SHALL use 3GPP/3GPP2 IMS mechanisms according to rules and procedures of [3GPP TS 24.229] / [3GPP2 X.S0013.4] with the clarifications given in this subclause.

7.2.1.13 SIP Session refresh procedure

On receiving a SIP re-INVITE request or a SIP UPDATE request including a Session-Expires header the PoC Server:

- 1. SHALL generate a SIP 200 "OK" response to the SIP request according to rules and procedures of [RFC3261];
- 2. SHALL include the Session-Expires header in a SIP 200 "OK" response and restart the SIP Session timer according to rules and procedures of [RFC4028], "UAS Behavior". The "refresher" parameter in the Session-Expires header SHALL be set to 'uac';
- 3. SHALL include in the SIP re-INVITE response a MIME SDP body as an SDP answer to the SDP offer as specified in subclause 7.2.1.1a "SDP answer generation", if SIP re-INVITE request is received; and,
- 4. SHALL send the SIP 200 "OK" response towards the Inviting PoC Client according to rules and procedures of SIP/IP Core.

On expiry of the SIP Session timer the PoC Server SHALL initiate disconnection of the SIP Session as specified in subclause 7.2.2.4 "Removal of Participant from PoC Session".

When the SIP/IP Core corresponds with 3GPP/3GPP2 IMS, the PoC Server SHALL use 3GPP/3GPP2 IMS session refresh mechanisms according to rules and procedures of [3GPP TS 24.229] / [3GPP2 X.S0013.4] with the clarifications given in this subclause.

7.2.1.14 PoC Session initiation policy

NOTE: PoC Session initiation policy is not applicable for Ad-hoc PoC Group Sessions and 1-1 PoC Sessions.

7.2.1.14.1 Pre-arranged PoC Group Session initiation policy

In the case of a Pre-arranged PoC Group the PoC Server performing the Controlling PoC Function SHALL initiate the PoC Session if the Authenticated Originator's PoC Address is allowed the action <allow-initiate-conference> and the <supported-services> element, if present, indicates the support for PoC service as specified in [OMA-PoC-Document-Mgmt].

In the case of a Pre-arranged PoC Group, the PoC Server performing the Controlling PoC Function SHALL invite members of the PoC Group contained in the <list> element of the PoC Group document as specified in [OMA-PoC-Document-Mgmt]. If the number of members of the PoC Group exceeds <max-participant-count>, the PoC Server performing the Controlling PoC Function SHALL invite only <max-participant-count> members from the list.

NOTE: How the PoC Server performing the Controlling PoC Function selects the <max-participant-count> members to invite is outside the scope of this specification.

7.2.1.14.2 Dispatch PoC Session initiation policy for PoC Dispatcher

If the invitation does not indicate a list of PoC Users, the PoC Server performing the Controlling PoC Function SHALL initiate the Dispatch PoC Session if the Authenticated Originator's PoC Address is allowed the action <allow-initiate-conference>, and the action <allow-dispatch> and the <supported-services> element, if present, indicates the support for PoC service as specified in [OMA-PoC-Document-Mgmt].

When a request to invite the Dispatch PoC Group is made by an authorized PoC User, the PoC Server performing the Controlling PoC Function SHALL invite all PoC Users contained in the <list> element of the Dispatch PoC Group document that are not allowed the action <allow-dispatch> (i.e. PoC Fleet Members), as specified in [OMA-PoC-Document-Mgmt].

The PoC Server performing the Controlling PoC Function MAY also invite other PoC Users contained in the <list> element of the Dispatch PoC Group document that are allowed the action <allow-dispatch> (i.e other PoC Dispatcher capable PoC Users).

NOTE 1: The decision to invite other PoC Dispatcher capable PoC Users can be based on local policies that are out of the scope of this specification.

If the invitation indicates a list of PoC Users, the PoC Server performing the Controlling PoC Function SHALL initiate the Dispatch PoC Session only if the Authenticated Originator's PoC Address is allowed the action <allow-initiate-conference>, and the action <allow-subconf> and the <supported-services> element, if present, indicates the support for PoC service and the action <allow-dispatch> as specified in [OMA-PoC-Document-Mgmt].

When a request to invite one or more PoC Users to a Dispatch PoC Session is made by an authorized PoC User, the PoC Server performing the Controlling PoC Function SHALL only invite the PoC Users that are contained in the <list> element of the Dispatch PoC Group document, as specified in [OMA-PoC-Document-Mgmt].

If the number of members of the PoC Group exceeds <max-participant-count>, the PoC Server performing the Controlling PoC Function SHALL invite only <max-participant-count> members to the Dispatch PoC Session.

NOTE 2: How the PoC Server performing the Controlling PoC Function selects the <max-participant-count> members to invite is outside the scope of this specification.

7.2.1.14.3 Dispatch PoC Session initiation policy for PoC Fleet Member

In the case of a Dispatch PoC Group, the PoC Server performing the Controlling PoC Function SHALL initiate the Dispatch PoC Session if the Authenticated Originator's PoC Address is allowed the action <allow-initiate-conference> and the <supported-services> element, if present, indicates the support for PoC service as specified in [OMA-PoC-Document-Mgmt].

When the request is made by an authorized PoC User, the PoC Server performing the Controlling PoC Function SHALL invite one of the PoC Users that are allowed the action <allow-dispatch> as specified in [OMA-PoC-Document-Mgmt].

NOTE: How the PoC Server performing the Controlling PoC Function selects the PoC User to be invited is out of scope for this specification.

7.2.1.15 PoC Session adding policy

The PoC Server SHALL NOT allow a PoC User to be added to an ongoing PoC Session if one or more PoC Boxes participates in the PoC Session.

When adding PoC Users to a PoC Session, the PoC Server performing the Controlling PoC Function SHALL invite PoC Users only if the Authenticated Originator's PoC Address is a Participant of the PoC Session.

Additionally in the case of a Pre-arranged PoC Group, Dispatch PoC Group or Chat PoC Group, the PoC Server performing the Controlling PoC Function SHALL invite PoC Users if the Authenticated Originator's PoC Address is allowed by the <allow-invite-users-dynamically> action as specified in [OMA-PoC-Document-Mgmt].

When a request to add one or more PoC Users to a Pre-arranged PoC Group Session or Dispatch PoC Session is made by an authorized Participant of an ongoing PoC Session, the PoC Server performing the Controlling PoC Function SHALL only invite PoC Users if the Invited PoC Users are listed in the <list> element of the PoC Group document as specified in [OMA-PoC-Document-Mgmt].

When a request to add one or more PoC Users to a Chat PoC Group Session is made by an authorized Participant of an ongoing PoC Session, the PoC Server performing the Controlling PoC Function SHALL only invite PoC Users if the Invited PoC Users are allowed to join by the <join-handling> action of the PoC Group's authorization rules as specified in [OMA-PoC-Document-Mgmt].

NOTE: In case of restricted Chat PoC Group, allowed Invited PoC Users are also listed in the <list> element of the PoC Group document.

PoC Server performing the Controlling PoC Function MAY apply a local policy, when adding PoC Users to 1-1 or Ad-hoc PoC Group Sessions. The PoC Server local policy may be e.g. that either only the PoC Session initiator or any of the Participants is allowed to add PoC Users.

7.2.1.16 PoC Session release policy

To enable the PoC Server to remove Participants from a PoC Session, the PoC Session release policy SHALL support the following operator configurable variables together with the possible values shown in parenthesis:

- 1. auto-release (true/false)
 - a) if 'true' the PoC Server SHALL remove rest of the Participants from Pre-arranged PoC Group Session and release the PoC Session when the originator leaves the PoC Session
 - b) if 'false' the PoC Server SHALL NOT remove rest of the Participants from Pre-arranged PoC Group Session nor release the PoC Session when the originator leaves the PoC Session

NOTE 1: 1-1 and Ad-Hoc PoC Group Sessions are always released when the PoC Session initiator leaves the PoC Session regardless of the value of "auto-release". Chat PoC Group Sessions are unaffected by auto-release.

- 2. session-release (true/false)
 - a) if 'true' the PoC Server SHALL remove rest of the Participants from PoC Group Session, when releasing the PoC User, who initiated the release request..
 - b) if 'false' the PoC Server SHALL NOT remove rest of the Participants from PoC Group Session, when releasing the PoC User, who initiated the release request.

NOTE 2: The session release condition is not applicable for 1-1 PoC Sessions and according to the local policy can be applied to Chat PoC Group Sessions.

- 3. session-max-length (seconds)

- a) if the PoC Session has lasted the specified amount of seconds the PoC Server SHALL release the PoC Session
- 4. number-of-remaining-participants (0/1)
 - a) if a Pre-arranged or Ad-hoc PoC Group Session has as many as or less than specified Participants left the PoC Server SHALL release the PoC Session. The possible values should be 0 or 1. This does not apply to Chat PoC Group Sessions.

NOTE 3: 1-1 PoC Sessions are always released whenever there is only one or no Participants left in the PoC Session regardless of the value of "number-of-remaining-participants".

- 5. release when PoC Speech is inactive (true/false)
 - a) If set to true the PoC Session SHALL be released when the inactivity timer for the Media-Control Entity with PoC Speech expires.
 - b) If set to false the PoC Session SHALL be released
 - i. when the inactivity timer has expired for all Media-Control Entities and there is no ongoing Discrete Media session not bound to a Media-floor Control Entity; or,
 - ii. when no more Media-Control Entities are connected to the PoC Session and there is no ongoing Discrete Media session not bound to a Media-floor Control Entity.

If there is no PoC Speech in the PoC Session the PoC Server SHALL behave as if the value of 'release when PoC Speech is inactive' is set to "false".

NOTE 4: The inactivity timers are defined in [OMA-POC-UP] "Timers".

The release policy SHALL include the following:

NOTE 5: Local policies may be defined by the operator and these local policies may impact the release policies defined here.

- 1. The PoC Server performing the Controlling PoC Function SHALL remove the rest of the Participants from the PoC Session it hosts and release the PoC Session:
 - a) if the PoC Session is an Ad-hoc or 1-1 PoC Session and the originator of the PoC Session leaves the PoC Session;
 - b) if the PoC Session is a Pre-arranged PoC Session and the originator of the PoC Session leaves the PoC Session and the auto-release has the value 'true';
 - c) if the PoC Session is a 1-1 PoC Session and there is only one or no Participants in the PoC Session;
 - d) if the PoC Session is a Pre-arranged or Ad-hoc PoC Group Session and there are as many as or less than "number-of-remaining-participants" Participants in the PoC Session;
 - e) if the PoC Session has lasted longer than the session-max-length variable specifies;
 - f) if the PoC Session is Pre-arranged or Chat PoC Group Session and the PoC Group is deleted;
 - g) if the PoC Session is a Dispatch PoC Session and the PoC Dispatcher leaves the PoC Session; and,
 - h) if the only Participants in a PoC Session are PoC Boxes.
- 2. The PoC Server performing the Controlling PoC Function SHALL remove a Participant from the PoC Session:
 - a) if the PoC Session is Pre-arranged PoC Group Session and the Participant is removed from the PoC Group;
 - b) if the PoC Session is Chat PoC Group Session and the Participant is no longer allowed to join by the <join-handling> action of the PoC Group's authorization rules, as specified in [OMA-PoC-Documents-Mgmt] ; or,

NOTE 6: If a Participant is no longer member of a restricted Chat PoC Group, the Participant is removed from the PoC Session.

- c) if the Participant has no Media in the PoC Session.

7.2.1.17 Generating a SIP NOTIFY request to the SIP REFER request

When generating a SIP NOTIFY request the PoC Server:

- 1. SHALL generate a SIP NOTIFY request according to rules and procedures of [RFC3265], [RFC3515] and rules and procedures of the SIP/IP Core;
- 2. SHALL include in the SIP NOTIFY request a MIME sipfrag body as specified in the [RFC3420], if generating a SIP NOTIFY request as the result of sending a SIP INVITE request, with:
 - a) the Status-Line received in the SIP response, (e.g. SIP 180 "Ringing" or SIP 200 "OK"), as specified in [RFC3261]. In case no SIP response is received the SIP 100 "Trying" SHALL be used;
 - b) the To header as received in the SIP response;
 - c) the Authenticated Originators PoC Address as if received in the SIP response;
 - d) the Warning header if it is received in the SIP response;
 - e) the P-Answer-State header if it is received in the SIP response from the Invited PoC User; and,
 - f) the Contact header if it is received in the SIP response.
- 3. SHALL include in the SIP NOTIFY request a MIME sipfrag body as specified in the [RFC3420] with the Status-Line received in the SIP response, (e.g. SIP 200 "OK"), as specified in [RFC3261], if generating a SIP NOTIFY request as the result of sending a SIP BYE request. In case no SIP response is received the SIP 100 "Trying" SHALL be used;
- 4. SHALL include a Resource-Priority header, according to rules and procedures of [RFC4412], if the PoC Server supports 'Official Government Use' QoE Profile, and if a Resource-Priority header was included in the received SIP REFER request; and,
- 5. SHALL send the SIP NOTIFY request to PoC Client according to rules and procedures of the SIP/IP Core.

The responses to the SIP NOTIFY request SHALL be handled in according to rules and procedures of [RFC3265], [RFC3515], and rules and procedures of the SIP/IP Core.

The PoC Server MAY terminate the implicit subscription created by the SIP REFER request and indicate the termination to the PoC Client according to rules and procedures of [RFC3265] and [RFC3515].

When the SIP/IP Core corresponds with 3GPP/3GPP2 IMS, the PoC Server SHALL use 3GPP/3GPP2 IMS mechanisms according to rules and procedures of [3GPP TS 24.229] / [3GPP2 X.S0013.4] with the clarifications given in this subclause.

7.2.1.18 PoC Session Participant information policy

The PoC Server performing the Controlling PoC Function SHALL only allow the subscription to the Participant information of the PoC Session hosted by the PoC Server, to those PoC Users which satisfy any of the following conditions:

- 1. if the PoC Session is Ad-hoc PoC Group Session or 1-1 PoC Session, the Authenticated Originator's PoC Address is
 - a) a PoC Address of a Participant of the PoC Session; or
 - b) a PoC Address of an Invited PoC User of the PoC Session;
- 2. if the PoC Session is Pre-arranged PoC Group Session or Chat PoC Group Session, the Authenticated Originator's PoC Address is allowed to subscribe to Participant information
 - a) according to the <allow-conference-state> action as specified in [OMA-PoC-Documents-Mgmt].

The PoC Server performing the Controlling PoC Function SHALL allow subscription to the Participant information from PoC Servers performing the Participant PoC Function if the following conditions are fulfilled:

- 1. the PoC Servers performing the Participant PoC Function is in the Media path i.e. the "b2bua" was received during the establishment of the PoC Session"; and,
- 2. if the PoC Servers performing the Participant PoC Function can be identified according to rules and procedures of [RFC4538].

7.2.1.19 PoC Session role transfer policy

In the case of a Dispatch PoC Session, the PoC Server performing the Controlling PoC Function SHALL initiate the transfer of the PoC Dispatcher role to the indicated PoC Users only if the indicated PoC User is allowed by the action <allow-dispatch> and the Authenticated Originator's PoC Address is allowed by the action <allow-dispatch> and the action <allow-dispatcher-role-transfer>, as specified in [PoC XDM-Specification].

7.2.1.20 Group Advertisement policy

The PoC Server performing the Controlling PoC Function SHALL allow the Authenticated Originator to advertise any PoC Group to the <list> element if the Request-URI is a PoC Group Identity identifying the restricted Chat PoC Group or the Pre-arranged PoC Group and unless the Authenticated Originator's PoC Address is blocked by the <block-group-advertisement-sending> action with value "true" as specified in [OMA-PoC-Document-Mgmt].

The PoC Server performing the Controlling PoC Function SHALL allow the Authenticated Originator to advertise any PoC Group to the PoC Address of the 'uri' attribute of the <entry> element in the XML resource list if the Request-URI is an Exploder-URI identifying a SIP MESSAGE URI-list service according to rules and procedures of [draft-uri-list-message].

NOTE: Authorization is not applied to the Group Advertisement requests advertising any PoC Group sent to a PoC Address identifying a PoC User.

7.2.1.21 Policy for allowing Media Streams in a PoC Session

The PoC Server performing the Controlling PoC Function SHALL allow only those PoC Users to initiate or add a particular Media Stream in the Ad-hoc and 1-1 PoC Session that the PoC Server hosts, if following conditions are fulfilled:

- 1. the PoC User is the PoC Session originator; or
- 2. when allowed by the PoC Server local policy

The PoC Server performing the Controlling PoC Function SHALL allow only those PoC Users to initiate or add a particular Media Stream in the Pre-arranged PoC Group Session, Dispatch PoC Session or Chat PoC Group Session that the PoC Server hosts, if

- 1. the Media Type is contained in the <group-media> element of
 - a) the <service> element indicating the PoC enabler of the <supported-services> element of the PoC Group; or,
 - b) the <all-services-except> element not indicating the PoC enabler of the <supported-services> element of the PoC Group; or,
- 2. the PoC User is authorized to initiate or add the particular Media Type by the <allow-media-handling> action of the PoC Group's authorization rules, as specified in [OMA-PoC-Document-Mgmt].

When the SIP/IP Core corresponds with 3GPP/3GPP2 IMS, the PoC Server SHALL use 3GPP/3GPP2 IMS mechanisms according to rules and procedures of [3GPP TS 24.229] / [3GPP2 X.S0013.4] with the clarifications given in this subclause.

7.2.1.22 Removing Media Streams from a PoC Session policy

NOTE: When a PoC User is not authorized to remove a particular Media Stream, the PoC Server performing the Controlling PoC Function does not remove the Media Stream from the PoC Session but rather disconnects the PoC Client from the Media Stream.

The PoC Server performing the Controlling PoC Function SHALL allow only those PoC Users to remove a particular Media Stream in the Ad-hoc and 1-1 PoC Session that it hosts if following conditions are fulfilled:

- 1. the PoC User is the PoC Session originator; or
- 2. when allowed by the PoC Server local policy

The PoC Server performing the Controlling PoC Function SHALL allow only those PoC Users to remove a particular Media from the Pre-arranged PoC Group Session, Dispatch PoC Session and Chat PoC Group Session that it hosts if following conditions are fulfilled:

- 1. the <remove-media-handling> action associated to the Authenticated Originator's PoC Address of the received SIP re-INVITE request or SIP UPDATE request is 'own' and the Media Type was added to the PoC Session by PoC Session initiation or PoC Session modification initiated by the PoC Client with the Authenticated Originator's PoC Address; or
- 2. the <remove-media-handling> action associated to the Authenticated Originator's PoC Address of the received SIP re-INVITE request or SIP UPDATE request is 'any'.

When the SIP/IP Core corresponds with 3GPP/3GPP2 IMS, the PoC Server SHALL use 3GPP/3GPP2 IMS mechanisms according to rules and procedures of [3GPP TS 24.229] / [3GPP2 X.S0013.4] with the clarifications given in this subclause.

7.2.1.23 Discrete Media request

Upon receiving a SIP MESSAGE request not containing a MIME body of the MIME Type application/vnd.poc.fdcfo+xml either

- 1. outside the SIP dialog used for a PoC Session containing the PoC feature tag '+g.poc.discretedia' in the Accept-Contact header; or,
- 2. inside the SIP dialog used for the PoC Session,

the PoC Server:

- 1. SHALL check the SIP MESSAGE request as specified in [OMA_IM_TS_Endorsement] "*Receiving SIP MESSAGE request for group communication*";
- 2. SHALL send the SIP MESSAGE request as specified in the subclause 7.2.2.7 "*Discrete Media request*" towards:
 - a) all other Participants, if the PoC Session is not using 1-many-1 communication method, and if the PoC Clients or PoC Boxes indicated support for Discrete Media by including the +g.poc.discretedia feature tag in the Contact header of the SIP INVITE or SIP 200 OK response returned when the PoC Session was established; or,
 - b) all Ordinary Participants or PoC Fleet Members if the PoC Session is using the 1-many-1 communication method, and if the PoC Clients indicated support for Discrete Media by including the +g.poc.discretedia feature tag in the Contact header of the SIP INVITE or SIP 200 OK response returned when the PoC Session was established and the SIP MESSAGE request is received from the Distinguished Participant or the PoC Dispatcher; or,
 - c) the Distinguished Participant or the PoC Dispatcher if the PoC Session is using the 1-many-1 communication method, and if the PoC Client indicated support for Discrete Media by including the +g.poc.discretedia feature tag in the Contact header of the SIP INVITE or SIP 200 OK response returned when the PoC Session was established and the SIP MESSAGE request is received from an Ordinary Participant or a PoC Fleet Member.

NOTE: Responses for the SIP MESSAGE request are described in [OMA_IM_TS_Endorsement] "*Receiving SIP MESSAGE request for group communication*".

When the SIP/IP Core corresponds with 3GPP/3GPP2 IMS, the PoC Server SHALL use 3GPP/3GPP2 IMS mechanisms according to rules and procedures of [3GPP TS 24.229] / [3GPP2 X.S0013.4] with the clarifications given in this subclause.

7.2.1.24 PoC Dispatcher role transfer request

Upon receiving a SIP REFER request with a Refer-To URI without a method parameter or with a method parameter set to 'INVITE' and the Refer-To URI includes an Accept-Contact header with the PoC Dispatcher feature tag '+g.poc.dispatcher' along with 'require' and 'explicit' parameters, the PoC Server:

- 1. SHALL perform actions to verify the Authenticated Originator's PoC Address of the Inviting PoC User corresponds with the Active PoC Dispatcher for the Dispatch PoC Session and authorize the request as specified in subclauses 7.2.1.19 "*PoC Session role transfer*". If the verification is not correct or the request is not authorized, the PoC Server SHALL return a SIP 403 "Forbidden" response with the warning text set to '111 User not allowed to transfer the dispatcher role' as specified in subclause 5.6 "*Warning header*". Otherwise, continue with the rest of the steps;
- 2. SHALL extract from the Refer-To header, according to rules and procedures of [RFC3515], the PoC Address of the target PoC Dispatcher or the PoC Group Identity of the Dispatch PoC Group representing any available PoC Dispatcher for the Dispatch PoC Group other than the current PoC Dispatcher (i.e., the sender of the REFER);

- 3. SHALL check whether the PoC User to be added, in addition to those already participating, does not exceed the maximum number of Participants allowed in the PoC Group Session according to the <max-participant-count> element, which is specified in [OMA-PoC-Documents-Mgmt]. If exceeded, the PoC Server SHALL return a SIP 486 "Busy Here" response with the warning text set to '102 Too many participants' to the originating network as specified in subclause 5.6 "Warning header". Otherwise, continue with the rest of the steps;
- 4. SHALL, for the case of the PoC Group Identity of the Dispatch PoC Group extracted from the Refer-To header representing any available PoC Dispatcher, determine the set of available PoC Users that are allowed by the action <allow-dispatch> in the PoC Group document and establish an ordered list for inviting them, and skip the next step.

NOTE 1: The procedures to determine the set of available PoC Users that are allowed by the action <allow-dispatch> in the PoC Group are outside the scope of this specification.

NOTE 2: The procedures to establish and ordered list for inviting the available PoC Dispatcher are outside the scope of this specification.

- 5. SHALL, for the case of a PoC Address extracted from the Refer-To header identifying an individual PoC User, authorize that PoC User according to subclause 7.2.1.19 "PoC Session role transfer". If it is not authorized, the PoC Server SHALL return a SIP 403 "Forbidden" response with the warning text set to '112 Target User not allowed to receive the dispatcher role' as specified in subclause 5.6 "Warning header". Otherwise, continue with the rest of the steps;
- 6. SHALL generate a SIP 2xx final response to the SIP REFER request according to rules and procedures of [RFC3515];
- 7. SHALL, if the SIP REFER request was an initial SIP request received outside of an existing dialog, include in the response to the SIP REFER request a Supported header with the option tag 'norefersub' according to rules and procedures of [RFC4488];
- 8. SHALL check the presence of the Refer-Sub header of the SIP REFER request and if it is present and it has the value 'false' then the PoC Server SHALL include in the response to the SIP REFER request a Refer-Sub header set to 'false' according to rules and procedures of [RFC4488];
- 9. SHALL send the SIP 2xx final response to the SIP REFER request towards the PoC Client according to rules and procedures of the SIP/IP Core;
- 10. SHALL invite the target PoC User as PoC Dispatcher following the procedures described in subclause 7.2.2.2 "PoC Session invitation request";
- 11. SHALL, for the case of a URI extracted from the Refer-To header representing any available PoC Dispatcher, invite subsequent possible PoC Dispatcher, as described in subclause 7.2.2.2 "PoC Session invitation request", until one accepts the transfer or the ordered list of possible PoC Dispatchers is exhausted;

NOTE 3: The amount of time that the PoC Server needs to wait before inviting another PoC Dispatcher from the list is outside the scope of this specification.

- 12. SHALL remove the Fleet Member from the PoC Session, as specified in subclause 7.2.2.4 "Removal of Participant from PoC Session" if a PoC User currently participating in the PoC Session as PoC Fleet Member accepts the PoC Dispatcher role; and,
- 13. SHALL generate and send to the PoC Client a SIP NOTIFY request(s) as specified in the subclause 7.2.1.17 "Generating a SIP NOTIFY request to the SIP REFER request" based on the progress of each SIP INVITE request sent, in accordance with steps 10 and 11 of this subclause, to PoC User(s) determined in steps 4 or 5 of this subclause.

NOTE 4: Once a PoC User accepts the PoC Dispatcher role, this PoC User becomes the Active PoC Dispatcher. The PoC Server considers the previous PoC User who had the role of PoC Dispatcher as a PoC Fleet Member of the ongoing Dispatch PoC Session.

Upon receiving a SIP 403 "Forbidden" response with the warning code 399 and the warning text '105 Ifocus already assigned', the PoC Server SHALL if the Refer-Sub header is not present or is set to 'true' in the SIP REFER request, generate and send to the PoC Client a SIP NOTIFY request as specified in the subclause 7.2.1.17 "Generating a SIP NOTIFY request to the SIP REFER request".

Upon receiving SIP provisional responses or SIP final responses for the SIP INVITE request(s) containing a P-Answer-State header with the value 'Unconfirmed' as specified in [RFC4964] and as specified in subclause 7.2.2.2 "PoC Session invitation request" the PoC Server:

- 1. SHALL discard the received SIP responses without forwarding them.

When the SIP/IP Core corresponds with 3GPP/3GPP2 IMS, the PoC Server SHALL use 3GPP/3GPP2 IMS mechanisms according to rules and procedures of [3GPP TS 24.229] / [3GPP2 X.S0013.4] with the clarifications given in this subclause.

7.2.1.25 FDCFO Proceed request

Upon receiving a SIP MESSAGE request inside the SIP dialog used for the PoC Session with a MIME body of the MIME Type application/vnd.poc.fdcfo+xml, the PoC Server:

- 1. SHALL perform actions to verify the Authenticated Originator's PoC Address and authorize the request according to local policy and if it is not authorized the PoC Server SHALL return a SIP 403 "Forbidden" response with the warning text set to '121 Function not allowed due to <detailed reason>' as specified in subclause 5.6 "Warning header". Otherwise, continue with the rest of the steps;
- 2. SHALL return a SIP 403 "Forbidden" response with the warning text set to '119 Anonymity not allowed' as specified in subclause 5.6 "Warning header", if anonymity is not allowed by the PoC Server and anonymity is requested. Otherwise, continue with the rest of the steps;
- 3. SHALL send the SIP MESSAGE request as specified in the subclause 7.2.2.8 "FDCFO Proceed request" towards each Participant that indicated support for the FDCFO Proceed feature during the PoC Session establishment; or,
- 4. SHALL return a SIP 480 "Temporarily Unavailable" response if no Participant in the PoC Session supports the FDCFO Proceed feature.

Upon receiving the first SIP 2xx response for the SIP MESSAGE requests from one of the Participants in the PoC Session the PoC Server:

- 1. SHALL generate a SIP 200 "OK" response according to rules and procedures of [RFC3428];
- 2. SHALL include the Server header to indicate the OMA PoC release version of the PoC Server as specified in subclause E.4.1 "Release version in User-agent and Server headers"; and,
- 3. SHALL send the SIP 200 "OK" response towards the PoC Client according to rules and procedures of the SIP/IP Core.

Upon receiving a SIP final response other than 2xx, that is one of the SIP 3xx, 4xx, 5xx or 6xx final responses the PoC Server:

- 1. SHALL generate and send towards the Inviting PoC Client a SIP final response with the status code equal to the status code of the received SIP final response with the lowest status code, if a SIP final response was received from all PoC Clients and the SIP 200 "OK" response is not yet sent.

When the SIP/IP Core corresponds with 3GPP/3GPP2 IMS, the PoC Server SHALL use 3GPP/3GPP2 IMS mechanisms according to rules and procedures of [TS24.229] / [3GPP2 X.S0013.4] with the clarifications given in this subclause.

7.2.1.26 Querying for capabilities

NOTE 1: Only the terminating side capability query procedures are described since any entity can send the SIP OPTIONS request

Upon receiving a SIP OPTIONS request, the PoC Server:

- 1. SHALL handle the SIP OPTIONS request as an SIP INVITE request as specified in the subclause 7.2.1.1b "PoC Session setup request" modified as follows:
 - a) any procedure checking the offered Media Types, offered the Media-floor Control Entities or the offered Media-floor Control Entity bindings are executed as if a MIME SDP body containing MBCP with bound PoC Speech was received;
 - b) the interactions with the User Plane are not performed;
 - c) the SIP request does not establish a PoC Session and does not add the PoC Client to the PoC Session;

- d) a SIP INVITE request to be sent to an Invited PoC Client is not sent and is handled as if the sent SIP INVITE request is responded with SIP 200 "OK" response with MIME body containing all the offered Media Types and Media-floor Control Entities including appropriate binding; and,
- e) if generating the SIP 200 "OK" response, the PoC Server additionally:
- i. SHOULD include in the SIP response an Allow header with the supported SIP methods according to rules and procedures of [RFC3261];
 - ii. SHOULD include in the SIP response an Accept header with the supported MIME body Media Types according to rules and procedures of [RFC3261];
 - iii. SHOULD include in the SIP response an Accept-Encoding header with the supported encoding formats according to rules and procedures of [RFC3261];
 - iv. SHOULD include in the SIP response an Accept-Language header with the supported languages according to rules and procedures of [RFC3261];
 - v. SHOULD include in the SIP response a Supported header with an option tags 'timer', 'multiple-refer' and 'norefersub' according to rules and procedures of [RFC3261];
 - vi. SHALL either remove the Contact headers from the SIP response or SHALL replace the Contact header value with the Request-URI value of the SIP OPTIONS request according to rules and procedures of [RFC3261];
 - vii. SHOULD include feature tags supported by the PoC Server in the Contact header and MAY include feature tags received from other Participants in the PoC Session in the Contact header if a Contact header is included in the SIP response; and,
 - viii. SHALL either
 1. remove the MIME SDP body from the SIP response; or,
 2. SHALL replace the MIME SDP body in the SIP response with a MIME SDP body containing the Media Types supported by the PoC Server and allowed according to the subclause 7.2.1.21 "*Policy for allowing Media Streams in a PoC Session*"; and the Media-floor Control Entities and the Media-floor Control Entity bindings supported by the PoC Server with port of each SDP m-line set to 0 according to rules and procedures of [RFC3261].

NOTE 2: If responses to SIP OPTIONS requests from other Participants in the PoC Session are available to the PoC Server the PoC Server can decide to include only Media Types or feature tags supported by all or a majority of the participants according to the PoC Servers local policy.

NOTE 3: The MIME SDP body included in the SIP 200 "OK" response to the SIP OPTIONS request is not an SDP answer.

When the SIP/IP Core corresponds with 3GPP/3GPP2 IMS, the PoC Server SHALL use 3GPP/3GPP2 IMS Session establishment mechanisms according to rules and procedures of [3GPP TS 24.229] / [3GPP2 X.S0013.4] with the clarifications given in this subclause.

7.2.1.27 PoC Session expulsion policy

The PoC Server performing the Controlling PoC Function:

- SHALL allow only Participants to expel PoC User(s) from the PoC Session;
- SHALL allow the PoC User to expelhimself from the PoC Session;
- SHALL expel other Participants only if the Authenticated Originator's PoC Address of the expelling PoC User is allowed by the <allow-expelling> action as specified in [OMA-PoC-Document-Mgmt], in the case of a Pre-arranged PoC Group Session, Dispatch PoC Group Session or Chat PoC Group Session;

- MAY apply a local policy, when expelling other Participants from a 1-1 PoC Session or an Ad-hoc PoC Group Session; and,

NOTE: The PoC Server local policy can be e.g. that either only the PoC Session initiator or any of the Participants is allowed to expel other Participants.

- SHALL expel the PoC Box in case the PoC Box is participating in the PoC Session on behalf of the PoC User and if the corresponding PoC User is expected to be expelled.

7.2.2 Request initiated by the Controlling PoC Function

7.2.2a Backward compatibility

When PoC Server performing Controlling PoC Function sends a SIP request towards the terminating PoC Network, the PoC Server SHALL perform the actions according to subclause 7.2.2 "*Request initiated by the Controlling PoC Function*", if the PoC Server does not know the version of OMA PoC specification supported by the terminating PoC Server or the version supported is the one specified in this specification.

When PoC Server performing Controlling PoC Function has learned by means which are out of scope of this specification that the terminating PoC Server supports only the PoC 1 specifications the PoC Server SHOULD perform the actions according to [OMA-PoC-1-CP] "*Request initiated by the Controlling PoC Function*", when sending a SIP request towards the terminating PoC Network.

When sending subsequent SIP requests inside an existing SIP dialog the PoC Server performing the Controlling PoC Function SHALL perform actions according to the rules and procedures of [OMA-PoC-1-CP] "*Request initiated by the Controlling PoC Function*", if the terminating PoC Server indicated in the User-Agent or Server headers of the previous SIP transaction that the terminating PoC Server supported only the PoC 1 specifications.

When the SIP/IP Core corresponds with 3GPP/3GPP2 IMS, the PoC Server SHALL use 3GPP/3GPP2 IMS mechanisms according to rules and procedures of [3GPP TS 24.229] / [3GPP2 X.S0013.4] with the clarifications given in this subclause.

7.2.2.1 General

NOTE 1: This subclause provides common procedures for other subclauses and is not meant to be applied unless referenced.

The PoC Server SHALL generate an initial SIP INVITE request according to rules and procedures of [RFC3261]. The PoC Server

- 1. SHALL include an Accept-Contact header with the PoC feature tag '+g.poc.talkburst' with 'require' and 'explicit' parameters according to rules and procedures of [RFC3841] in all initial SIP INVITE requests;
- 2. SHALL include the PoC feature tag '+g.poc.discretemedia' in the Contact header, if it was included in the incoming SIPrequest;
- 3. SHALL include Accept-Contact headers with a feature tag 'sip.automata' and the feature tag 'sip.actor' and the feature tag 'sip.description' with the corresponding value along with 'require' and 'explicit' according to rules and procedures of [RFC3841] if included in the incoming SIP INVITE request or in the URI of the Refer-To header of the incoming SIP REFER request;
- 4. SHALL include Reject-Contact headers with a feature tag 'sip.automata' and the feature tag 'sip.actor' and the feature tag 'sip.description' with the corresponding value along with 'require' and 'explicit' according to rules and procedures of [RFC3841] if included in the incoming SIP INVITE request or in the URI of the Refer-To header of the incoming SIP REFER request;
- 5. SHALL set the Request-URI to the PoC Address of the PoC User to be invited;

NOTE 2: All uri-parameters included in the URI in the MIME resources-list or in the Refer-to header are included by the PoC Server in case of an Ad-hoc PoC Group Session or a 1-1 PoC Session.

- 6. SHALL include the User-Agent header to indicate the OMA PoC release version of the PoC Server as specified in subclause E.4.1 "Release version in User-agent and Server headers";

NOTE 3: The use of the option tag 'precondition', as specified in [RFC3312], is not defined for the POC-2 reference point.

- 7. SHALL include an option tag '100rel' in a Supported header according to rules and procedures of [RFC3262];
- 8. SHALL include an option tag 'norefersub' in a Supported header according to rules and procedures of [RFC4488];
- 9. SHALL include Authenticated Originator's PoC Address as specified in subclause 5.2 "Authenticated Originator's PoC Address":
 - a) with the URI set to the PoC Address of the Inviting PoC Client and the Nick Name to the one defined for this PoC User in the incoming SIP request in case of 1-1 PoC Session and Ad-hoc PoC Group Session as specified in subclause 5.4 "Nick Name"; or,
 - b) with the URI set to the PoC Group Identity and the Nick Name to the one defined for this PoC Group in the PoC Group definitions with the Session Type uri-parameter "session=prearranged" or "session=chat" as specified in E.5.1 "Session Type uri-parameter" in case of the Pre-arranged or Chat PoC Group respectively.
- 10. SHALL include a Referred-By header with the PoC Address and the Nick Name of the Inviting PoC Client;
- 11. SHALL include a MIME message/sipfrag body containing a User-Agent header with the value of the User-Agent header of the received SIP request, if the Inviting PoC Client is compliant only to the OMA PoC version 1.0 specification;
- 12. SHALL include in the Contact header as PoC Session Identity the contact address of the PoC Session with the PoC feature tag '+g.poc.talkburst' and the feature tag 'isfocus' and a Session Type uri-parameter "session=1-1", or "session=adhoc", or "session=prearranged", or "session=chat" as appropriate for the type of the PoC Session as specified in E.5.1 "Session Type uri-parameter";
- 13. SHOULD include the Session-Expires header according to rules and procedures of [RFC4028], "Generating an Initial Session Refresh Request". The refresher parameter SHALL be omitted;
- 14. SHALL include the Supported header set to 'timer';
- 15. SHALL include value 'id' in a Privacy header according to rules and procedures of [RFC3325], if anonymity is requested with the Privacy header by the Inviting PoC Client;
- 16. SHOULD include an Allow header the SIP methods supported in this SIP dialog according to rules and procedures of [RFC3261];
- 17. SHALL include unmodified Answer-Mode header if present in the incoming SIP INVITE request or in the Refer-To URI of the incoming SIP REFER request that caused the outgoing SIP INVITE request to be generated;
- 18. SHALL include unmodified Priv-Answer-Mode header if present in the incoming SIP INVITE request or in the Refer-To URI of the incoming SIP REFER request that caused the outgoing SIP INVITE request to be generated, if manual answer override is supported; and,
- 19. SHALL include a Resource-Priority header according to rules and procedures of [RFC4412] set to the priority value assigned for the PoC Session, if the QoE Profile assigned to the PoC Session is 'Official Government Use' and if the PoC Server supports this QoE Profile.

On receipt of the SIP 200 "OK" response to the initial outgoing SIP INVITE request the PoC Server:

- 1. SHALL start the SIP Session timer according to rules and procedures of [RFC4028];
- 2. SHALL cache SIP feature tags, if received in the Contact header, and if the specific feature tags are supported;
- 3. SHALL create and cache the Nick Name, as specified in subclause 5.4 "Nick Name"; and,
- 4. SHALL cache the uri parameter "b2bua", if the uri-parameter is present in the URI of the PoC Server performing Participating PoC Function in the Contact header and if the uri parameter is used according to local policy.

When the SIP/IP Core corresponds with 3GPP/3GPP2 IMS, the PoC Server SHALL use 3GPP/3GPP2 IMS Session establishment mechanisms according to rules and procedures of [3GPP TS 24.229] / [3GPP2 X.S0013.4] with the clarifications given in this subclause.

7.2.2.1a SDP offer generation

The SDP offer is generated based on the received SDP offer. The PoC Server SHALL offer either the same or a subset of the Media Streams and the connected Media-floor Control Entities as included in the received SDP offer.

NOTE 1: PoC Server can reduce the number of offered Media Streams and Media-floor Control Entities based on local policy.

When receiving an SDP offer to initiate a Pre-arranged PoC Group Session, the PoC Server:

1. SHALL offer to the Invited PoC User all the Media Types with bound Media-Floor Control Entities offered in the received SDP offer and allowed as specified in subclause 7.2.1.21 "*Policy for allowing Media Streams in a PoC Session*"; and,
2. SHALL offer to the Invited PoC User the Discrete Media without bound Media-Floor Control Entity offered in the received SDP offer and allowed as specified in subclause 7.2.1.21 "*Policy for allowing Media Streams in a PoC Session*".

When receiving a SIP request to add a new PoC User to an existing PoC Session, the PoC Server SHALL offer the Media Stream currently used in the PoC Session.

When receiving an SDP offer to modify the existing PoC Session by adding a Media Stream to the PoC Session or removing a Media Stream from the PoC Session or both, the PoC Server:

- 1. SHALL offer to other Participants all the Media Streams used currently in the PoC Session except the Media Stream, which the PoC Session modification originator disconnected from and for which Media Stream removal policy allows to be removed as described in subclause 7.2.1.22 "*Removing Media Streams from a PoC Session policy*"; and,
- 2. SHALL offer to other Participants the new Media Stream from the received SDP offer, if allowed by the Media Stream adding policy as specified in subclause 7.2.1.21 "*Policy for allowing Media Streams in a PoC Session*".

When composing an SDP offer according to rules and procedures of [RFC3264] and [RFC4566] the PoC Server:

- 1. SHALL set the IP address of the PoC Server for each offered Media Stream from the list contained in the received SDP offer and for each offered Media-floor Control Entity from the list contained in the received SDP offer;
- 2. SHALL include the media-level section for each offered Media Stream from the list contained in the received SDP offer consisting of:
 - a) the port number for the Media Stream selected as specified in [OMA-PoC-UP] "*Port numbers*";
 - b) the codec(s) and Media Parameters selected by the PoC Server from the list contained in the received SDP offer and/or other codec(s), if any, that the PoC Server is capable of transcoding;

NOTE 2: The Media Parameters of the Discrete Media are specified in [OMA_IM_TS_Endorsement].

NOTE 3: The PoC Server can narrow the selection of Media Parameters and codec(s) according to the local policy, which may be a function of one or more of the following: Inter-operator service level agreement; domain of the Invited PoC Client; other factors.

- c) the "a=label" attribute with a unique value as specified in [RFC4574], if the Media Stream is to be connected to a Media-floor Control Entity except when only PoC Speech with Talk Burst Control Protocol is offered;
- d) the "i=" field set to "speech" as specified in subclause 5.10 "*PoC Speech*" when PoC Speech with MBP is offered.

NOTE 4: PoC Speech Media exists at most once in the SDP offer.

- e) the IP address of the PoC Server and port number to be used for RTCP at the PoC Server selected as specified in [OMA-PoC-UP] "*Port numbers*", according to rules and procedures of [RFC3605], if the Media Stream uses the RTCP protocol as specified in [OMA-POC-1-UP] and other than the default IP address or port number specified by the [RFC3550] is to be used;

- f) the "a=upcc:0" attribute as specified in [RFC3108], if the PoC Server supports PoC Media Traffic Optimisation, the Participant did not put the PoC Session on hold, the media-level section offers a Continuous Media and the 1-many-1 communication method is not used in the PoC Session; and,
 - g) under the media level definition of MSRP, add to "a=accept-types:" SDP attribute MIME Types "application/vnd.oma.poc.final-report+xml", "application/vnd.oma.poc.detailed-progress-report+xml" and optionally "application/vnd.oma.poc.optimized-progress-report+xml" if any of these were included in the received SDP offer and if supported by the PoC Server.
- 3. SHALL include the media-level section of each offered Media-floor Control Entity from the list contained in the received SDP offer, if any Media-floor Control Entity is offered:
 - a) the format list field for the Media-floor Control Entity set to "TBCP";
 - b) the Media-floor Control Entity parameters selected by the PoC Server from those contained in the received SDP offer;
 - c) the port number for Media-floor Control Entity selected as specified in [OMA-PoC-UP] "Port numbers";
 - d) the "a=floorid:0 mstrm" attribute with value(s) referencing the Media Stream as specified in [RFC4583] intended to be connected to the Media-floor Control Entity except when only PoC Speech with Talk Burst Control Protocol as specified in [OMA-POC-1-UP] is offered; and,
 - e) optionally TBCP MIME parameters as specified in E.3 "SDP Extensions", TBCP MIME parameter "multimedia=1" is included, unless only PoC Speech with Talk Burst Control Protocol as specified in [OMA-POC-1-UP] is offered;
 - 4. SHALL mark as rejected according to rules and procedures of [RFC3264] the Media-floor Control Entity and all the Media Stream bound to the rejected Media-floor Control Entity, if the Media-floor Control Entity is rejected;
 - 5. SHALL mark the Media Stream as rejected according to rules and procedures of [RFC3264], if the Media Stream is rejected;
 - 6. SHALL include the QoE Profile assigned for the PoC Session, as specified in subclause E.3.2 "QoE Profile", if QoE Profiles are enabled and if a QoE Profile attribute was included in the received SDP offer. If the QoE Profile assigned for the PoC Session is marked as "mandatory", the QoE Profile attribute SHALL include the strength-tag, as specified in subclause E.3.2 "QoE Profile".

When Composing SDP offer, the PoC Server:

- 1. SHALL bind the media-level section that identifies PoC Speech to Media-floor Control Entity as in the received SDP offer, if PoC Speech is offered;
- 2. SHALL bind the media-level section that identifies Video to Media-floor Control Entity as in the received SDP offer, if Video is offered;
- 3. SHALL bind the media-level section that identifies Audio to Media-floor Control Entity as in the received SDP offer, if Audio is offered; and,
- 4. SHALL bind the media-level section that identifies Discrete Media to Media-floor Control Entity as in the received SDP offer, if Discrete Media is offered and bound to a Media-floor Control Entity.

When the SIP/IP Core corresponds with 3GPP/3GPP2 IMS, the PoC Server SHALL use 3GPP/3GPP2 IMS mechanisms according to rules and procedures of [3GPP TS 24.229] / [3GPP2 X.S0013.4] with the clarifications given in this subclause.

7.2.2.2 PoC Session invitation requests

This subclause describes the procedures for inviting a PoC User to a PoC Session. The procedure is initiated by the PoC Server as the result of an action specified in subclause 7.2.1 "Requests terminated at the Controlling PoC Function".

The PoC Server:

- 1. SHALL generate a SIP INVITE request as specified in subclause 7.2.2.1 "General";
- 2. SHALL include in the SIP INVITE request a MIME SDP body as an SDP offer based on the SDP offer in the received SIP INVITE request from the originating network as specified in the subclause 7.2.1.1a "SDP offer generation";
- 3. SHALL include the remaining MIME bodies with media content contained into the incoming SIP INVITE request, if Included Media Content is supported by the PoC Server and if a MIME body with media was included and not removed as described in 7.2.1.2 "Ad-hoc PoC Group and 1-1 PoC Session setup request" or 7.2.1.3 "Pre-

arranged PoC Group Session setup request" and if the SIP INVITE request is the result of an initialization of a PoC Session.

- 4. MAY proceed the following actions, when establishing an Ad-hoc PoC Group Session and 1-1 PoC Session;
 - a) include in the SIP INVITE request the MIME resource-lists body contained in the incoming SIP INVITE request according to rules and procedures of [draft-URI-list]; and,
 - b) set the "copyControl" attribute to 'to' for the URIs without both the "copyControl" and the "anonymize" attribute values in the list based on the PoC Server local policy. If the URI is to be anonymous set the "anonymize" attribute to 'true', according to rules and procedures of [draft-URI-list-capacity].
- 5. MAY proceed the following actions, when adding Participants to a PoC Session as specified in the subclause 7.2.1.8 *"Adding Participants to PoC Session request"*;
 - a) include in the SIP INVITE request the MIME resource-lists body contained in the incoming SIP REFER request according to rules and procedures of [draft-URI-list];
 - b) set the "copyControl" attribute to 'to' for the URIs without both the "copyControl" and the "anonymize" attribute values in the list based on the PoC Server local policy. If the URI is to be anonymous, set the "anonymize" attribute to 'true', according to rules and procedures of [draft-URI-list-capacity]; and,
 - c) add to the list the URI(s) of the Invited PoC Client(s) already participating in the ongoing PoC Session along with their "copyControl" and "anonymize" attribute values from the cached information.
- 6. SHALL include the text content in the Subject header contained in the incoming SIP INVITE request or in the Subject header included in the URI of the Refer-To header of the incoming SIP REFER request, if Text Content is supported by the PoC Server and if text is received in Subject header and not removed and if the SIP INVITE request is the initialization of a PoC Session;
- 7. SHALL include the referenced media content in the Alert-Info header or the Call-Info header or both contained in the incoming SIP INVITE request or in the Subject header included in the URI of the Refer-To header of the incoming SIP REFER request, if Referenced Media Content is supported by the PoC Server and if referenced media content is received in Alert-Info header and not removed and if the SIP INVITE request is the initialization of a PoC Session;
- 8. SHALL, in case of an invitation to a Dispatch PoC Session, as specified in subclauses 7.2.1.3. 2 *"Dispatch PoC Session setup request from PoC Dispatcher"*, 7.2.1.3. 3 *"Dispatch PoC Session setup request from PoC Fleet Member"* 7.2.1.24 *"PoC Dispatcher role transfer request"* and subclause 7.2.1.8 *"Adding Participants to PoC Session request"*, include in the Authenticated Originator's PoC Address and in the Contact header of the SIP INVITE request the Dispatch Type uri-parameter "dispatch=entire-group" or "dispatch=sub-group" as appropriate for the type of the Dispatch PoC Session, as specified in E.5.2 *"Dispatch Type uri-parameter"*;
- 9. SHALL in case the PoC User is invited as PoC Dispatcher for a Dispatch PoC Session, as specified in subclauses 7.2.1.3.3 *"Dispatch PoC Session setup request from PoC Fleet Member"* and 7.2.1.24 *"PoC Dispatcher role transfer request"*, include an Accept-Contact header with the PoC Dispatcher feature tag '+g.poc.dispatcher' along with 'require' and 'explicit' parameters according to rules and procedures of [RFC3841];
- 10. SHALL send the SIP INVITE request towards the SIP/IP Core according to rules and procedures of the SIP/IP Core.

Upon receiving a SIP 183 "Session Progress" response containing a Require header with the option tag '100rel' and containing a P-Answer-State header with the value "Unconfirmed" in response to the SIP INVITE request the PoC Server:

- 1. SHALL according to rules and procedures of [RFC3262] send a SIP PRACK request to the other PoC Server according to rules and procedures of the SIP/IP Core;
- 2. SHALL create and cache an Anonymous PoC Address for the Invited PoC User as specified in subclause 5.9 *"Anonymous PoC Address"*, if anonymity is requested via a Privacy header containing the tag 'id' in the SIP response and Anonymous PoC Address has not been created yet for the Invited PoC User;

NOTE 1: The Anonymous PoC Address is an alias for the PoC User, and this address appears in Participant Information and the User Plane Taken message. This alias PoC Address is used when expelling the PoC Participant from the PoC Session.

- 3. SHOULD generate a notification in case of the first SIP 183 "Session Progress" response and MAY generate a notification in case of the second SIP 183 "Session Progress" response and afterwards to the PoC Clients, which have subscribed to the conference state event package that an Invited PoC User has joined in the PoC Group

Session, as specified in subclause 7.2.1.11.2 "*Generating a SIP NOTIFY request*" if a Privacy header is included in the SIP 183 "Session Progress" response; and,

- 4. SHOULD send the SIP NOTIFY request in case of the first SIP 183 "Session Progress" response and MAY send the SIP NOTIFY in case of the second SIP 183 "Session Progress" response and afterwards according to rules and procedures of the SIP/IP Core if a Privacy header is included in the SIP 183 "Session Progress" response.

Upon receiving a SIP 180 "Ringing" response for the SIP INVITE request the PoC Server:

- 1. SHALL create and cache an Anonymous PoC Address for the Invited PoC User as specified in subclause 5.9 "*Anonymous PoC Address*", if anonymity is requested via a Privacy header containing the tag 'id' in the SIP response and Anonymous PoC Address has not been created yet for the Invited PoC User;

NOTE 2: The Anonymous PoC Address is an alias for the PoC User, and this address appears in Participant Information and the User Plane Taken message. This alias PoC Address is used when expelling the PoC Participant from the PoC Session.

- 2. MAY generate a notification to the PoC Clients, which have subscribed to the conference state event package that an Invited PoC User is alerted to join to the PoC Group Session, as specified in subclause 7.2.1.11.2 "*Generating a SIP NOTIFY request*"; and,
- 3. MAY send the SIP NOTIFY request to the PoC Client according to rules and procedures of the SIP/IP Core.

Upon receiving SIP provisional responses for the SIP INVITE request(s) the PoC Server:

- 1. SHALL cache the list of supported SIP methods if received in the Allow header; and
- 2. SHALL cache the contact received in the Contact header;

Upon receiving SIP 200 "OK" response for the SIP INVITE request the PoC Server:

- 1. SHALL cache the list of supported SIP methods if received in the Allow header;
- 2. SHALL cache the contact received in the Contact header;
- 3. SHALL in the case of an invitation to a Pre-arranged PoC Group Session or to a Chat PoC Group Session, check whether the privacy is allowed for this PoC Group, when anonymity is requested with the Privacy header containing the tag 'id'. If not allowed, the PoC Server SHALL according to local policy either accept the SIP response ignoring the privacy request or release the PoC Client from the PoC Session immediately as specified in 7.2.2.4 "*Removal of Participant from PoC Session*". Allowing privacy in the PoC Group is defined using <allow-anonymity> element as specified in [OMA-PoC-Document-Mgmt]. If accepted, continue with the rest of the steps;
- 4. SHALL create and cache an Anonymous PoC Address as specified in subclause 5.9 "*Anonymous PoC Address*" and a Nick Name as specified in subclause 5.4 "*Nick Name*" for the Invited PoC User, if anonymity is requested via a Privacy header containing the tag 'id' in the SIP response and Anonymous PoC Address has not been created yet for the Invited PoC User;

NOTE 3: The Anonymous PoC Address is an alias for the PoC User, and this address appears in Participant Information and the User Plane Taken message. This alias PoC Address is used when expelling the PoC Participant from the PoC Session.

- 5. SHALL check if the feature tag 'sip.automata' along with the feature tag 'sip.actor' with the value of 'msg-taker' or 'principal' and if the feature tag 'sip.actor' with the value 'principal' then also the the feature tag 'sip.description' with the value "poc recording device", is contained in the Contact header and if that is the case the PoC Server SHALL either
 - a) perform actions in subclause 7.2.24 "*Removal of Participant from PoC Session*" if more than one PoC User was invited without an explicit request to be routed to a PoC Box; or,
 - b) continue with the rest of the steps in case of a 1-1 PoC Session or if all PoC Users were invited with the explicit request to be routed to a PoC Box.

NOTE 4: An Accept-Contact header with the feature tag 'sip.automata' and the feature tag 'sip.actor' with the value of 'msg-taker' or 'principal' (and in the case of the feature tag 'sip.actor' with the value 'principal' also the feature tag 'sip.description' with the value "poc recording device") along with parameters 'explicit' and 'require' is the explicit request to route an invitation to a PoC Box.

- 6. SHALL check if the PoC Dispatcher feature tag '+g.poc.dispatcher' is contained in the Contact header, in case the outgoing SIP INVITE request contained an Accept-Contact header with the PoC Dispatcher feature tag '+g.poc.dispatcher' along with 'require' and 'explicit' parameters. If it is not present, the PoC Server SHALL perform the actions specified in subclause 7.2.2.4 "*Removal of Participant from PoC Session*" and do not proceed with the rest of the steps. Otherwise, the PoC Server SHALL mark the Invited PoC User as the Active PoC Dispatcher for the Dispatch PoC Session;
- 7. SHOULD use the "b=AS" attribute as specified in [OMA-PoC-UP] "*Media Buffering*", if included in the SDP offer;
- 8. SHALL interact with the User Plane as specified in [OMA-PoC-UP] "*Controlling PoC Function procedures at PoC Session initialization*";
- 9. SHALL generate a notification to the PoC Clients, which have subscribed to the conference state event package that an Invited PoC User has joined in the PoC Group Session, as specified in subclause 7.2.1.11.2 "*Generating a SIP NOTIFY request*"; and,
- 10. SHALL send the SIP NOTIFY request to the PoC Client according to rules and procedures of the SIP/IP Core.

NOTE 5: Procedures towards Inviting PoC Clients, when SIP 183 "Session Progress", SIP 180 "Ringing" SIP 200 "OK", or other SIP final response (4xx, 5xx, 6xx) is received, are specified subclause 7.2.1 "*Requests Terminated at the Controlling PoC Function*".

NOTE 6: If a SIP 4xx response is received due to media content included in a MIME body or in a Subject header or in an Alert-Info header or in a Call-Info header, the PoC Server does not resend the SIP INVITE request without the MIME bodies or headers or both causing the SIP 4xx response.

Upon receiving SIP 403 "Forbidden" response for the SIP INVITE request with the warning text '105 Isfocus already assigned' included in a Warning header, the PoC Server:

NOTE 7: In the case the text part is replaced with a text in another language as specified in the subclause 5.6 "*Warning header*" the PoC Server identifies the warning text using the code 105.

- 1. SHALL check if the response contains a URI-List according to rules and procedures of [draft-URI-list-handling]. If not, the PoC Server SHALL behave as specified in the subclause 7.2.1.2 "*Ad-hoc PoC Group and 1-1 PoC Session setup request*", when receiving a SIP final response other than 2xx or 3xx. Otherwise, continue with the rest of the steps;
- 2. SHALL check the MIME resource-lists body that the maximum number of Participants allowed in an Ad-hoc PoC Group Session is not exceeded. If exceeded, or when the local policy prevents further processing and no final response is yet sent, the first response towards the Inviting PoC Client SHALL include the warning text set to '102 Too many participants' or '128 Too many embedded groups' as specified in subclause 5.6 "*Warning header*". Otherwise continue with the rest of the steps;

NOTE 8: With regards to 'MAX-ADHOC-GROUP-SIZE' parameter, the initiator of the PoC Session is also counted as a Participant.

- 3. SHALL invite the PoC Users and/or Pre-arranged PoC Groups listed in the MIME resource-lists body of the SIP 403 "Forbidden" response, as specified in the subclause 7.2.2.2 "*PoC Session invitation request*". During the same Ad-hoc PoC Group Session initiation the PoC Server SHALL issue only one SIP INVITE request per one PoC Address and per one PoC Group Identity.

Upon receiving SIP 415 "Unsupported Media Type" response for the SIP INVITE request and if the only accepted MIME type is "application/sdp", the PoC Server SHOULD re-perform actions described in this subclause only including the MIME bodies indicated in the SIP 415 "Unsupported Media Type" response.

Upon receiving a SIP 408 "Request Timeout", SIP 480 "Temporarily Unavailable", SIP 486 "Busy Here", SIP 503 "Service Unavailable", SIP 504 "Server Timeout", SIP 600 "Busy Everywhere" or SIP 603 "Decline" response to a SIP INVITE request for a Dispatch PoC Session, the PoC Server

- 1. SHALL create and cache an Anonymous PoC Address for the Invited PoC User as specified in subclause 5.9 "Anonymous PoC Address", if anonymity is requested via a Privacy header containing the tag 'id' in the SIP response and Anonymous PoC Address has not been created yet for the Invited PoC User;

NOTE 9: The Anonymous PoC Address is an alias for the PoC User, and this address appears in Participant Information and the User Plane Taken message. This alias PoC Address is used when expelling the PoC Participant from the PoC Session.

- 2. MAY resend the SIP INVITE request at a later time towards the SIP/IP Core according to rules and procedures of the SIP/IP Core, if the Dispatch PoC Session is still on-going.

NOTE 10: The time that the PoC Server needs to wait before resending the SIP INVITE request is out of the scope of this specification.

Upon receiving other SIP final response to the SIP INVITE request, the PoC Server

- 1. SHALL create and cache an Anonymous PoC Address for the Invited PoC User as specified in subclause 5.9 "Anonymous PoC Address", if anonymity is requested via a Privacy header containing the tag 'id' in the SIP response, Anonymous PoC Address has not been created yet for the Invited PoC User and the Invited PoC Client already responded with SIP 180 "Ringing" response;

NOTE 11: The Anonymous PoC Address is an alias for the PoC User, and this address appears in Participant Information and the User Plane Taken message. This alias PoC Address is used when expelling the PoC Participant from the PoC Session.

When the SIP/IP Core corresponds with 3GPP/3GPP2 IMS, the PoC Server SHALL use 3GPP/3GPP2 IMS mechanisms according to rules and procedures of [3GPP TS 24.229] / [3GPP2 X.S0013.4] with the clarifications given in this subclause.

7.2.2.3 Cancel of PoC Session invitation requests

When the PoC Server needs to cancel the PoC Session invitation request and when it has not received a SIP final response, the PoC Server SHALL cancel the SIP INVITE request acting as UAC according to rules and procedures of [RFC3261];

When the SIP/IP Core corresponds with 3GPP/3GPP2 IMS, the PoC Server SHALL use 3GPP/3GPP2 IMS mechanisms according to rules and procedures of [3GPP TS 24.229] / [3GPP2 X.S0013.4] with the clarifications given in this subclause.

7.2.2.4 Removal of Participant from PoC Session

When a Participant needs to be removed from the PoC Session the PoC Server:

- 1. SHALL interact with User Plane as specified in [OMA-PoC-UP] "Controlling PoC Function procedures at PoC Session release";
- 2. SHALL generate a SIP BYE request according to rules and procedures of [RFC3261];
- 3. SHOULD include a Reason header with text '*Preemption ;cause=1 ; text="UA preemption"*', according to rules and procedures of [RFC 4411] if the Participant is being released due to the arrival of a SIP INVITE request to the Controlling PoC Function and the maximum number of Participants has already been reached for the ongoing PoC Session. The PoC Server SHOULD choose language of the reason-text in the Reason header depending on the preferred language indicated in Accept-Language header received from the PoC Client in the SIP INVITE request or SIP 200 "OK" response to the SIP INVITE request, if the language is supported;

NOTE: The release of a Participant can happen when a PoC User wants to join a PoC Session in which the maximum number of Participants has been reached and the joining PoC User uses 'Official Government Use' QoE Profile.

- 4. SHOULD include a Resource-Priority header according to rules and procedures of [RFC4412] set to the priority value assigned for the PoC Session, if the QoE Profile assigned to the PoC Session is 'Official Government Use' and if the PoC Server supports this QoE Profile; and,
- 5. SHALL send the SIP BYE request towards the PoC Client of the Participant according to rules and procedures of the SIP/IP Core.

Upon receiving a SIP 200 "OK" for the SIP BYE request, the PoC Server:

- 1. SHALL interact with the User Plane as specified in [OMA-PoC-UP] "*Controlling PoC Function procedures at PoC Session release*" for releasing User Plane resources towards the PoC Server performing Participating PoC Function (or towards the PoC Client if there is no Participating PoC Function on the User Plane path);
- 2. SHALL generate a notification to the PoC Clients, which have subscribed to the conference state event package that a PoC User has left the PoC Group Session, as specified in subclause 7.2.1.11.2 "*Generating a SIP NOTIFY request*"; and,
- 3. SHALL send the SIP NOTIFY request to the PoC Clients according to rules and procedures of the SIP/IP Core.

When the SIP/IP Core corresponds with 3GPP/3GPP2 IMS, the PoC Server SHALL use 3GPP/3GPP2 IMS mechanisms according to rules and procedures of [3GPP TS 24.229] / [3GPP2 X.S0013.4] with the clarifications given in this subclause.

7.2.2.5 PoC Session modification

This subclause describes the procedures for adding new a Media Stream to the PoC Session, for removing a Media Stream from the PoC Session, for the changing the bindings between Media Streams and Media-floor Control Entities and for modifying Media Parameters and for combinations of these for an ongoing PoC Session. The procedure MAY be initiated by the PoC Server as the result of an action specified in subclause 7.2.1 "*Requests terminated at the Controlling PoC Function*" or MAY be initiated by the PoC Server e.g. for PoC Media Traffic Optimisation purposes.

When modifying the PoC Session, the PoC Server:

- 1. MAY generate a SIP UPDATE request according to rules and procedures of [RFC3311], if the PoC Server supports the SIP UPDATE request and if
 - a) the PoC Server performing the Participating PoC Function has indicated support for the SIP UPDATE method;
 - b) the offered Media Streams and the offered Media-floor Control Entities are used in the PoC Session by the terminating PoC Client; and,
 - c) the offered Media-floor Control Entity binding of each Media Stream used and offered is the same as used; and SHALL generate a SIP re-INVITE request according to rules and procedures of [RFC3261], if the SIP UPDATE request is not generated;
- 2. SHALL include in a SIP request a MIME SDP body as an SDP offer as specified in subclause 7.2.2.1a "*SDP offer generation*";
- 3. SHALL include a Resource-Priority header according to rules and procedures of [RFC4412], if the QoE Profile assigned to the PoC Session is 'Official Government Use' and if the PoC Server supports this QoE Profile;
- 4. SHALL interact with the User Plane as specified in [OMA-PoC-UP] "*Controlling PoC Function procedures when disconnecting from a Media Type*"; and,
- 5. SHALL send the SIP request towards PoC Client according to rules and procedures of SIP/IP Core.

Upon receiving a SIP 200 "OK" response the PoC Server:

- 1. SHALL interact with the User Plane as specified in [OMA-PoC-UP] "*Controlling PoC Function procedures when disconnecting from a Media Type*", if offered Media Stream, which is used in a PoC Session and is marked rejected in the received SDP answer or if the current Media-floor Control Entity binding of a Media Stream, that is currently used in the PoC Session and accepted in the SDP answer, is not the same as in the received SDP answer;
- 2. SHALL interact with the User Plane as specified in [OMA-PoC-UP] "*Controlling PoC Function procedures when connecting to a Media Type*", if offered Media Stream, which is used in the PoC Session, but not used by the terminating PoC Client and it is marked accepted in the received SDP answer or if the current Media-floor Control Entity binding of a Media Stream, that is currently used in the PoC Session and accepted in the SDP answer, is not the same as in the received SDP answer;
- 3. SHALL interact with the User Plane as specified in [OMA-PoC-UP] "*User Plane adaptation*" for updating the User Plane with the new codecs, Media formats or Media Parameters, if offered changes in codecs, Media formats or Media Parameters compared to those earlier accepted by the terminating PoC Client;
- 4. SHOULD use the "b=AS" attribute as specified in [OMA-PoC-UP] "*Media Buffering*", if included in the SDP offer; and,

- 5. SHALL release the PoC Session as specified in 7.2.2.4 "*Removal of Participant from a PoC Session*" if the criteria for releasing the PoC Session as specified in 7.2.1.16 "*PoC Session release policy*" is fulfilled and if a Media Type or a Media-floor Control entity is removed from the PoC Session.

NOTE: If the PoC Session modification offering removal of a currently used Media Stream fails or is not accepted or the PoC Session modification offering a currently used Media Stream with the Media-floor Control Entity binding different than currently used fails or is not accepted, the PoC Server does not transfer the Media of the Media Stream to and from the Participant.

The PoC Server SHALL continue to use the current Media Parameters until it has received a SIP 200 "OK" response.

When the SIP/IP Core corresponds with 3GPP/3GPP2 IMS, the PoC Server SHALL use 3GPP/3GPP2 IMS mechanisms according to rules and procedures of [3GPP TS 24.229] / [3GPP2 X.S0013.4] with the clarifications given in this subclause.

7.2.2.6 Group Advertisement request

This subclause describes the procedure that the PoC Server uses when sending a Group Advertisement. The procedure is initiated by the PoC Server as the result of an action specified in subclause 7.2.1.12 "*Group Advertisement request*".

When sending a Group Advertisement request the PoC Server:

- 1. SHALL generate a SIP MESSAGE request according to rules and procedures of [RFC3428];
- 2. SHALL include an Accept-Contact header with the PoC feature tag '+g.poc.groupad' along with 'require' and 'explicit' parameters according to rules and procedures of [RFC3841];
- 3. SHALL include the Authenticated Originator's PoC Address as specified in subclause 5.2 "*Authenticated Originator's PoC Address*" with the URI set to the PoC Address of the initiating PoC User;
- 4. SHALL include PoC specific content in form of application/vnd.poc.group-advertisement+xml indicating Group Advertisement. If this procedure has been initiated by a request received from a SIP/IP Core then the content SHALL be the same as in the request received from the SIP/IP Core;

NOTE: The Group Advertisement request is received from a SIP/IP Core, when generated by Shared Group XDMS.

- 5. SHALL include the remaining MIME bodies with media content contained in the incoming SIP MESSAGE request, if Included Media Content is supported by the PoC Server and if a MIME body with media was included and not removed as described in 7.2.1.12 "*Group Advertisement request*";
- 6. SHALL include the text content in the Subject header contained in the incoming SIP MESSAGE request, if Text Content is supported by the PoC Server and if text is received in Subject header and not removed;
- 7. SHALL include the referenced media content in the Call-Info header contained in the incoming SIP MESSAGE request, if Referenced Media Content is supported by the PoC Server and if referenced media content is received in Call-Info header and not removed;
- 8. SHALL set the Request-URI to the PoC Address; and,
- 9. SHALL forward the SIP MESSAGE request towards the SIP/IP Core according to rules and procedures of the SIP/IP Core.

Upon receiving SIP 415 "Unsupported Media Type" response for the SIP MESSAGE request and if the only accepted MIME type is "vnd.poc.group-advertisement+xml", the PoC Server SHOULD re-perform actions described in this subclause only including the MIME bodies indicated in the SIP 415 "Unsupported Media Type" response.

When the SIP/IP Core corresponds with 3GPP/3GPP2 IMS, the PoC Server SHALL use 3GPP/3GPP2 IMS mechanisms according to rules and procedures of [3GPP TS 24.229] / [3GPP2 X.S0013.4] with the clarifications given in this subclause.

7.2.2.7 Discrete Media request

This subclause describes the procedure that the PoC Server uses when sending Discrete Media to Participants in a PoC Session. The procedure is initiated by the PoC Server as the result of an action specified in subclause 7.2.1.23 "*Discrete Media request*".

When sending a Discrete Media request the PoC Server:

- 1. SHALL generate the SIP MESSAGE request as specified in [OMA_IM_TS_Endorsement] "*SIP MESSAGE request*";
- 2. SHALL include an Accept-Contact header with the PoC feature tag '+g.poc.discretemedia' according to rules and procedures of [RFC3841], if to be sent outside the SIP dialog used for the PoC Session; and,
- 3. SHALL forward the SIP MESSAGE request towards the SIP/IP Core according to rules and procedures of the SIP/IP Core as specified in [OMA_IM_TS_Endorsement] "*SIP MESSAGE request*".

NOTE 1: Responses for the SIP MESSAGE request are described in [OMA_IM_TS_Endorsement] "*SIP MESSAGE request*".

NOTE 2: In order to reach a PoC Box, the SIP MESSAGE request is sent in the SIP dialog of the PoC Session.

When the SIP/IP Core corresponds with 3GPP/3GPP2 IMS, the PoC Server SHALL use 3GPP/3GPP2 IMS mechanisms according to rules and procedures of [3GPP TS 24.229] / [3GPP2 X.S0013.4] with the clarifications given in this subclause.

7.2.2.8 FDCFO Proceed request

This procedure is initiated by the PoC Server as the result of an action specified in subclause 7.2.1.25 "*FDCFO Proceed request*".

When sending a FDCFO Proceed request the PoC Server:

- 1. SHALL generate the SIP MESSAGE request according to rules and procedures of [RFC3428];
- 2. SHALL include the MIME application/vnd.poc.fdcfo+xml body received in the incoming SIP MESSAGE request;
- 3. SHALL include the Authenticated Originator's PoC Address as specified in subclause 5.2 "*Authenticated Originator's PoC Address*" with the URI set to the PoC Address of the initiating PoC User;
- 4. SHALL include the Privacy header with the value "id" if privacy is requested;
- 5. SHALL include the User-Agent header to indicate the OMA PoC release version of the PoC Server as specified in subclause E.4.1 "*Release version in User-agent and Server headers*";
- 6. SHALL forward the SIP MESSAGE request towards the SIP/IP Core inside the SIP dialog used for the PoC Session according to rules and procedures of the SIP/IP Core.

NOTE: Procedures towards the PoC Client sending the FDCFO Proceed request, when a SIP 2xx response, or other SIP final response (4xx, 5xx, 6xx) is received, are specified in subclause 7.2.1.25 "*FDCFO Proceed request*".

When the SIP/IP Core corresponds with 3GPP/3GPP2 IMS, the PoC Server SHALL use 3GPP/3GPP2 IMS mechanisms according to rules and procedures of [TS24.229] / [3GPP2 X.S0013.4] with the clarifications given in this subclause.

7.3 Participating PoC Function procedures

7.3.1 Requests initiated by the served PoC User

7.3.1a Backward compatibility

When PoC Server performing Participating PoC Function sends a SIP request towards the terminating PoC Network, the PoC Server SHALL perform the actions according to subclause 7.3.1 "*Request initiated by the served PoC User*", if the PoC Server does not know the version of OMA PoC specification supported by the terminating PoC Server or the version supported is the one specified in this specification.

When PoC Server performing Participating PoC Function in the originating PoC Network has learned by means which are out of scope of this specification that the terminating PoC Server supports only the PoC 1 specifications the PoC Server SHOULD perform the actions according to [OMA-PoC-1-CP] "*Requests initiated by the served PoC User*", when sending a SIP request towards the terminating PoC Network.

When sending a SIP request on behalf of a served PoC Client which indicated in the User-Agent header of the SIP PUBLISH request setting the PoC Service Settings that the PoC Client supports only the PoC 1 specifications, the PoC Server performing the Participating PoC Function SHALL perform actions according to the rules and procedures of [OMA-PoC-1-CP] "*Request initiated by the Served PoC User*".

When sending subsequent SIP requests inside an existing SIP dialog the PoC Server performing the Participating PoC Function SHALL perform actions according to the rules and procedures of [OMA-PoC-1-CP] "*Request initiated by the Served PoC User*", if the terminating PoC Server indicated in the User-Agent or Server headers of the previous SIP transaction that the terminating PoC Server supported only the PoC 1 specifications.

When the SIP/IP Core corresponds with 3GPP/3GPP2 IMS, the PoC Server SHALL use 3GPP/3GPP2 IMS mechanisms according to rules and procedures of [3GPP TS 24.229] / [3GPP2 X.S0013.4] with the clarifications given in this subclause.

7.3.1.1 General

NOTE 1: This subclause provides common procedures for other subclauses and is not meant to be applied unless referenced.

Upon receiving from the served PoC Client an initial SIP INVITE request or SIP REFER request that requires an initial SIP INVITE request to be sent, the PoC Server:

- 1. SHALL generate an initial SIP INVITE request according to rules and procedures of [RFC3261];
- 2. SHALL include in the SIP INVITE request the Privacy header unmodified according to rules and procedures of [RFC3325], if the incoming SIP INVITE or SIP REFER request contained a Privacy header;
- 3. SHALL include the Nick Name in the Authenticated Originator's PoC Address as specified in subclause 5.4 "*Nick Name*";
- 4. SHALL include an Accept-Contact header with the PoC feature tag '+g.poc.talkburst' with 'require' and 'explicit' parameters according to rules and procedures of [RFC3841];
- 5. SHALL include a User-Agent header to indicate the OMA PoC release version of the PoC Server as specified in subclause E.4.1 "*Release version in User-agent and Server headers*";
- 6. SHALL include in the Contact header the feature tag '+g.poc.fdcfo', as specified subclause E.2.4 "*FDCFO Proceed Feature Tag*", if the PoC Server supports the FDCFO Proceed feature, and the SIP INVITE request from the PoC Client contains this feature tag;

NOTE 2: The use of the option tag 'precondition', as specified in [RFC3312], is not defined for the POC-1 or POC-2 reference points.

NOTE 3: The use of the option tag '100rel', as specified in [RFC3262] is not defined for the POC-1 reference point.

- 7. SHOULD include the Session-Expires header according to rules and procedures of [RFC4028], "*Generating an Initial Session Refresh Request*". It is RECOMMENDED that the refresher parameter is omitted. If included, the refresher parameter SHALL be set to 'uac'.
- 8. SHALL include the option tag 'timer' in a Supported header ;
- 9. SHALL cache the allowed SIP methods if received in the Allow header;
- 10. SHOULD include an Allow header with the SIP methods supported in this SIP dialog according to rules and procedures of [RFC3261];
- 11. SHALL include the Authenticated Originator's PoC Address received in the incoming SIP INVITE request in the outgoing SIP INVITE request;
- 12. SHALL perform the following actions, if the incoming SIP INVITE request contained an Answer-Mode header, or the incoming SIP REFER request contained a Refer-To URI with an Answer-Mode header:
 - a) include an Answer-Mode header unmodified if the received value is set to 'Manual;Require';
 - b) discard the Answer-Mode header if the received value is set to 'Auto' or 'Manual'; or

- c) return a SIP 403 "Forbidden" response with the warning text set to '121 Function not allowed due to <detailed reason>' as specified in subclause 5.6 "Warning header" and not continue with the rest of the steps if the received value is set to 'Auto;Require';
- 13. SHALL perform the following actions, if the incoming SIP INVITE request contained a Priv-Answer-Mode header, or the incoming SIP REFER request contained a Refer-To URI with a Priv-Answer-Mode header and manual answer override is supported:
 - a) include a Priv-Answer-Mode header unmodified if the received value is set to 'Auto';
 - b) return a SIP 403 "Forbidden" response with the warning text set to '121 Function not allowed due to <detailed reason>' as specified in subclause 5.6 "Warning header" and not continue with the rest of the steps if the received value is set to anything other than 'Auto';
- 14. SHALL include in the Contact header the PoC feature tag '+g.poc.talkburst';
- 15. SHALL include the PoC feature tag '+g.poc.discretedia' if it was included in the incoming SIP request;
- 16. SHALL copy the feature tag '+g.poc.dispatcher' if it was included in the Contact header of the incoming SIP request;
- 17. SHALL include the feature tag '+g.poc.interworking' if it was included in the Contact header of the incoming SIP request, if the PoC Server supports the PoC Interworking Service;
- 18. SHALL, if the incoming SIP INVITE or SIP REFER request contained a MIME resource-lists body with the PoC Address(es) of Invited PoC User(s), include a Content-Type header with multipart/mixed, as specified in [RFC2046], and copy the MIME resource-lists body, according to rules and procedures of [draft-URI-list];
- 19. SHALL copy the Accept-Language header, if included in the incoming SIP request;
- 20. SHALL insert the uri-parameter "b2bua" to the URI of the PoC Server in the Contact header of the initial SIP request as specified in E.5.3 "Back to back UA uri-parameter", if the PoC Server performing Participating PoC Function indicates according to local policy to the Controlling PoC Function, that it acts as a B2BUA and stays on the Media path; and,
- 21. SHALL include in the Accept-Contact header the feature tag 'sip.automata' along with the feature tag 'sip.actor' the feature tag 'sip.description' with the corresponding values and the parameters 'explicit' and 'require' if included in the Accept-Contact header of the incoming SIP INVITE request or in the Accept-Contact header contained within the Refer-To URI from the incoming SIP REFER request.

When sending SIP provisional responses, other than the SIP 100 "Trying" response, to the SIP INVITE request and if the PoC Server is acting as a B2BUA, the PoC Server:

- 1. SHALL generate the SIP provisional response according to rules and procedures of [RFC3261];
- 2. SHALL include a Server header with the OMA PoC release version of the PoC Server as specified in subclause E.4.1 "Release version in User-agent and Server headers" if has not already been sent in a provisional response for this dialog;
- 3. SHALL include the Authenticated Originator's PoC Address, along with any possible uri-parameter, if received in the incoming SIP response, in the outgoing SIP provisional response;
- 4. SHALL include a SIP URI for the Contact header as follows, if not already sent in a provisional response for this dialog:
 - a) constructed such that the PoC Server can also resolve it back to the original SIP URI provided in the Contact header of the provisional response by the Controlling PoC Function;
 - b) include the PoC feature tag '+g.poc.talkburst';
 - c) include the feature tag 'isfocus';
 - d) copy the feature tag '+g.poc.dispatcher', 'sip.automata', 'sip.actor', 'sip.description' with their corresponding value, if any of these are included in the Contact header of the incoming received SIP response; and,
 - e) include the Session Type uri-parameter and any other uri-parameter provided in the Contact header of the provisional response received from the Controlling PoC Function.
- 5. SHALL include value 'id' in the Privacy header according to rules and procedures of [RFC3325], if the privacy is requested.

When sending a SIP 200 "OK" response to the SIP INVITE request and if the PoC Server is acting as a B2BUA the PoC Server

- 1. SHALL generate a SIP 200 "OK" response according to rules and procedures of [RFC3261];
- 2. SHALL include a Server header to indicate the OMA PoC release version of the PoC Server as specified in subclause E.4.1 "*Release version in User-agent and Server headers*" if has not already been sent in a provisional response for this dialog;
- 3. SHALL include the option tag 'timer' in a Require header;
- 4. SHALL include the Session-Expires header according to rules and procedures of [RFC4028], "*UAS Behavior*". The "refresher" parameter in the Session-Expires header SHALL be set to 'uac';
- 5. SHALL start the SIP Session timer according to rules and procedures of [RFC4028];
- 6. SHOULD include an Allow header with the SIP methods supported in this SIP dialog according to rules and procedures of [RFC3261];
- 7. SHALL include a SIP URI for the Contact header as follows:
 - a) constructed such that the PoC Server can also resolve it back to the original SIP URI provided in the Contact header of the SIP 200 "OK" response by the Controlling PoC Function;
 - b) include the PoC feature tag '+g.poc.talkburst';
 - c) include the feature tag 'isfocus';
 - d) copy the feature tag '+g.poc.dispatcher', 'sip.automata', 'sip.actor', 'sip.description' with their corresponding value, if any of these are included in the Contact header of the incoming received SIP response; and,
 - e) include the Session Type uri-parameter and any other uri-parameter provided in the Contact header of the SIP 200 "OK" response received from the Controlling PoC Function.
- 8. SHALL include the Authenticated Originator's PoC Address, along with any possible uri-parameter, if received in the incoming SIP 200 "OK" response in outgoing SIP 200 "OK" response.
- 9. SHALL include value 'id' in the Privacy header according to rules and procedures of [RFC3325], if the privacy is requested; and,
- 10. SHALL include the option tag 'norefersub' in a Supported header according to rules and procedures of [RFC4488].

When the SIP/IP Core corresponds with 3GPP/3GPP2 IMS, the PoC Server SHALL use 3GPP/3GPP2 IMS Session mechanisms according to rules and procedures of [3GPP TS 24.229] / [3GPP2 X.S0013.4] with the clarifications given in this subclause.

7.3.1.1a SDP offer generation in case of On-demand session

The SDP offer is generated based on the received SDP offer. The PoC Server SHALL offer the same or a subset of Media Streams and the connected Media-floor Control Entities as included in the received SDP offer.

When composing the SDP offer according to rules and procedures of [RFC3264] and [RFC4566] the PoC Server:

- 1. SHALL set the IP address of the PoC Server for each offered Media Stream from the list contained in the received SDP offer and for each offered Media-floor Control Entity from the list contained in the received SDP offer;
- 2. SHALL include the media-level section for each offered Media from the list contained in the received SDP offer consisting of:
 - a) the port number for the Media Stream selected as specified in [OMA-PoC-UP] "*Port numbers*";
 - b) the codec(s) and Media Parameters selected by the PoC Server from the list contained in the received SDP offer and/or, if transcoding is supported by the PoC Server, other codec(s), that the PoC Server is capable of transcoding;

NOTE 1: The Media Parameters of the Discrete Media are specified in [OMA_IM_TS_Endorsement].

NOTE 2: The PoC Server can narrow the selection of Media Parameters and codec(s) according to the local policy, which can be a function of one or more of the following: Inter-operator service level agreement; domain of the Invited PoC Client; other factors.

- c) the "a=label" attribute with a unique value as specified in [RFC4574], if the Media Stream is to be connected to a Media-floor Control Entity except when only PoC Speech with Talk Burst Control Protocol as specified in [OMA-POC-1-UP] is offered;
- d) the "i=" field set to "speech" as specified in subclause 5.10 "PoC Speech" when PoC Speech with MBCP is offered;

NOTE 3: PoC Speech Media exists at most once in the SDP offer.

- e) the IP address of the PoC Server and port number to be used for RTCP at the PoC Server selected as specified in [OMA-PoC-UP] "Port numbers", according to rules and procedures of [RFC3605], if the Media Stream uses the RTCP protocol and other than the default IP address or port number specified by the [RFC3550] is to be used;
 - f) the "a=upcc:0" attribute as specified in [RFC3108], if the PoC Server supports the PoC Media Traffic Optimisation, the Participant did not put the PoC Session on hold and the media-level section offers a Continuous Media; and,
 - g) the "a=sendonly" attribute according to rules and procedures of [RFC4566], if the PoC Server supports the PoC Media Traffic Optimisation, the Participant did not put the PoC Session on hold, the media-level section offers a Continuous Media, the PoC Server performing the Controlling PoC Function indicated the PoC Media Traffic Optimisation support in the SIP Session of the other Participant and the RTP Session of the SIP Session of the other Participant is selected for the Media transmission between the PoC Server and the PoC Server performing the Controlling PoC Function.
- 3. SHALL include the media-level section of each offered Media-floor Control Entity from the list contained in the received SDP offer, if any Media-floor Control Entity is offered:
 - a) the format list field for the Media-floor Control Entity set to "TBCP";
 - b) the Media-floor Control Entity parameters selected by the PoC Server from those contained in the received SDP offer;
 - c) the port number for Media-floor Control Entity selected as specified in [OMA-PoC-UP] "Port numbers";
 - d) the "a=floorid:0 mstrm" attribute with value(s) referencing the Media Stream as specified in [RFC4583] intended to be connected to the Media-floor Control Entity except when only PoC Speech with Talk Burst Control Protocol as specified in [OMA-POC-1-UP] is offered; and,
 - e) optionally TBCP MIME parameters in the received SDP offer as specified in E.3 "SDP Extensions", TBCP MIME parameter "multimedia=1" is included, unless only PoC Speech with Talk Burst Control Protocol as specified in [OMA-POC-1-UP] is offered.
 - 4. SHALL mark as rejected according to rules and procedures of [RFC3264] the Media-floor Control Entity and all the Media Stream bound to the rejected Media-floor Control Entity, if the Media-floor Control Entity is rejected;
 - 5. SHALL mark the Media Stream as rejected according to rules and procedures of [RFC3264], if the Media Stream is rejected; and,
 - 6. SHALL include the received QoE Profile attribute as specified in subclause E.3.2 "QoE Profile", if QoE Profiles are enabled and if a QoE Profile attribute is present in the received SDP offer.

When composing an SDP offer, the PoC Server:

- 1. SHALL bind the media-level section that identifies PoC Speech to Media-floor Control Entity as in the received SDP offer, if PoC Speech is offered;
- 2. SHALL bind the media-level section that identifies Video to Media-floor Control Entity as in the received SDP offer, if Video is offered;
- 3. SHALL bind the media-level section that identifies Audio to Media-floor Control Entity as in the received SDP offer, if Audio is offered; and,
- 4. SHALL bind the media-level section that identifies Discrete Media to the Media-floor Control Entity as in the received SDP offer, if Discrete Media is offered and bound to the Media-floor Control Entity.

When the SIP/IP Core corresponds with 3GPP/3GPP2 IMS, the PoC Server SHALL use 3GPP/3GPP2 IMS mechanisms according to rules and procedures of [3GPP TS 24.229] / [3GPP2 X.S0013.4] with the clarifications given in this subclause.

7.3.1.1b SDP offer generation in case of Pre-established Session

When composing an SDP offer according to rules and procedures of [RFC3264] and [RFC4566] the PoC Server:

- 1. SHALL set the IP address of the PoC Server for each offered Media Streams from the SDP negotiated during the Pre-established Session establishment as specified subclause 7.3.1.2 "*Pre-established Session*";
- 2. SHALL set the IP address of the PoC Server for each offered Media-floor Control Entity from the SDP negotiated during the Pre-established Session establishment as specified subclause 7.3.1.2 "*Pre-established Session*";
- 3. SHALL include the media-level section for each offered Media Stream from the list contained in the SDP negotiated during the Pre-established Session establishment as specified subclause 7.3.1.2 "*Pre-established Session*" consisting of:
 - a) the port number for the Media Stream selected as specified in [OMA-PoC-UP] "*Port numbers*";
 - b) the codec(s) and Media Parameters as in the SDP negotiated during the Pre-established Session establishment as specified subclause 7.3.1.2 "*Pre-established Session*" and/or, if transcoding is supported by the PoC Server, other codec(s), that the PoC Server is capable of transcoding;

NOTE 1: The Media Parameters of the Discrete Media are specified in [OMA_IM_TS_Endorsement].

NOTE 2: If the Media Stream is inactive in the SDP negotiated during the Pre-established Session establishment as specified subclause 7.3.1.2 "*Pre-established Session*" then the Media Stream in the SDP offer is also set to inactive.

- c) the "a=label" attribute with a unique value as specified in [RFC4574], if the Media Stream is to be connected to a Media-floor Control Entity except when only PoC Speech with Talk Burst Control Protocol as specified in [OMA-POC-1-UP] is offered;
- d) the "i=" field set to "speech" as specified in subclause 5.10 "*PoC Speech*" when PoC Speech with MBCP is offered;

NOTE 3: PoC Speech Media exists at most once in the SDP offer.

- e) the IP address of the PoC Server and port number to be used for RTCP at the PoC Server selected as specified in [OMA-PoC-UP] "*Port numbers*", according to rules and procedures of [RFC3605], if the Media Stream uses the RTCP protocol and other than the default IP address or port number specified by the [RFC3550] is to be used;
- f) the "a=upcc:0" attribute as specified in [RFC3108], if the PoC Server supports the PoC Media Traffic Optimisation, the Participant did not put the PoC Session on hold and the media-level section offers a Continuous Media; and,
- g) the "a=sendonly" attribute according to rules and procedures of [RFC4566], if the PoC Server supports the PoC Media Traffic Optimisation, the Participant did not put the PoC Session on hold, the media-level section offers a Continuous Media, the PoC Server performing the Controlling PoC Function included in the SDP body of the other Participant SIP Session the "a=upcc:0" attribute for the Media Stream of the same Media Type and the RTP Session of the SIP Session of the other Participant is selected for the Media transmission between the PoC Server and the PoC Server performing the Controlling PoC Function.
- 4. SHALL include the media-level section of each offered Media-floor Control Entity from the list contained in the SDP negotiated during the Pre-established Session establishment as specified subclause 7.3.1.2 "*Pre-established Session*", if any Media-floor Control Entity is offered:
 - a) the format list field for the Media-floor Control Entity set to "TBCP";
 - b) the Media-floor Control Entity parameters as in the SDP negotiated during the Pre-established Session establishment as specified subclause 7.3.1.2 "*Pre-established Session*";
 - c) the port number for Media-floor Control Entity selected as specified in [OMA-PoC-UP] "*Port numbers*";
 - d) the "a=floorid:0 mstrm" attribute with value(s) referencing the Media Stream as specified in [RFC4583] intended to be connected to the Media-floor Control Entity except when only PoC Speech with Talk Burst Control Protocol is offered; and,

- e) optionally TBCP MIME parameters in the received SDP offer as specified in E.3 "*SDP Extensions*", TBCP MIME parameter "multimedia=1" is included, unless only PoC Speech with Talk Burst Control Protocol as specified in [OMA-POC-1-UP] is offered.
- 5. SHALL mark as rejected according to rules and procedures of [RFC3264] the Media-floor Control Entity and all the Media Streams bound to the rejected Media-floor Control Entity, if the Media-floor Control Entity is rejected;
- 6. SHALL mark the Media Stream as rejected according to rules and procedures of [RFC3264], if the Media Stream is rejected; and,
- 7. SHALL include the QoE Profile attribute corresponding to the negotiated QoE Profile, as specified in subclause E.3.2 "*QoE Profile*", if QoE Profiles are enabled and if a QoE Profile was negotiated during the Pre-established Session establishment or modification, as specified in subclauses 7.3.1.2 "*Pre-established Session*" and 7.3.1.3 "*Pre-established Session modification*".

When composing an SDP offer, the PoC Server:

- 1. SHALL bind the media-level section that identifies PoC Speech to Media-floor Control Entity as in the SDP negotiated during the Pre-established Session establishment as specified subclause 7.3.1.2 "*Pre-established Session*", if PoC Speech is offered;
- 2. SHALL bind the media-level section that identifies Video to Media-floor Control Entity as in the SDP negotiated during the Pre-established Session establishment as specified subclause 7.3.1.2 "*Pre-established Session*", if Video is offered;
- 3. SHALL bind the media-level section that identifies Audio to Media-floor Control Entity as in the SDP negotiated during the Pre-established Session establishment as specified subclause 7.3.1.2 "*Pre-established Session*", if Audio is offered; and,
- 4. SHALL bind the media-level section that identifies Discrete Media to Media-floor Control Entity as in the SDP negotiated during the Pre-established Session establishment as specified subclause 7.3.1.2 "*Pre-established Session*", if Discrete Media is offered and bound to the Media-floor Control Entity.

When the SIP/IP Core corresponds with 3GPP/3GPP2 IMS, the PoC Server SHALL use 3GPP/3GPP2 IMS mechanisms according to rules and procedures of [3GPP TS 24.229] / [3GPP2 X.S0013.4] with the clarifications given in this subclause.

7.3.1.1c SDP answer generation

When composing an SDP answer according to rules and procedures of [RFC3264] and [RFC4566] the PoC Server:

- 1. SHALL set the IP address of the PoC Server for each accepted Media Streams from the list contained in the received SDP offer and for each accepted Media-floor Control Entity from the list contained in the received SDP offer;
- 2. SHALL include the media-level section for each accepted Media Stream from the list contained in the received SDP offer consisting of:
 - a) the port number for the Media Stream selected as specified in [OMA-PoC-UP] "*Port numbers*";
 - b) the codec(s) and Media Parameters selected by the PoC Server from the list contained in the received SDP offer, and those contained in the SDP answer in SIP 200 "OK" response from the Controlling PoC Function, if already received;

NOTE 1: The Media Parameters of the Discrete Media are defined in [OMA_IM_TS_Endorsement].

- c) the "a=label" attribute with a unique value as specified in [RFC4574], if the Media Stream is to be connected to a Media-floor Control Entity except when only PoC Speech with Talk Burst Control Protocol as specified in [OMA-POC-1-UP] is accepted; and,
- d) the IP address of the PoC Server and port number to be used for RTCP selected as specified in [OMA-PoC-UP] "*Port numbers*", according to rules and procedures of [RFC3605], if the Media Stream uses the RTCP protocol and other than the default IP address or port number specified by the [RFC3550] is to be used;
- 3. SHALL include for any Media-floor Control Entity, that is offered in the received SDP offer and accepted in the SDP answer by the PoC Server, the media-level section of each offered Media-floor Control Entity consisting of:
 - a) the format list field for the Media-floor Control Entity is set to "TBCP";

- b) the Media-floor Control Entity parameters selected by the PoC Server from the list contained in the received SDP offer;
 - c) the port number for Media-floor Control Entity selected as specified in [OMA-PoC-UP] "*Port numbers*";
 - d) the "a=floorid:0 mstrm" attribute with value(s) referencing the Media Stream as specified in [RFC4583] intended to be connected the Media-floor Control Entity except when only PoC Speech with Talk Burst Control Protocol as specified in [OMA-POC-1-UP] is accepted; and,
 - e) optionally TBCP MIME parameters as specified in E.3 "*SDP Extensions*", including if needed the TBCP MIME parameter "multimedia" with the appropriated value as specified in E.3 "*SDP Extensions*";
- 4. SHALL mark as rejected according to rules and procedures of [RFC3264] the Media-floor Control Entity and all the Media Streams bound to the rejected Media-floor Control Entity, if the Media-floor Control Entity is rejected;
 - 5. SHALL mark the Media Stream as rejected according to rules and procedures of [RFC3264], if the Media Stream is rejected;
 - 6. SHALL include the QoE Profile attribute corresponding to the QoE Profile assigned to the PoC Session, as specified in subclause E.3.2 "*QoE Profile*", if QoE Profiles are enabled and if a QoE Profile attribute was present in the SDP offer.

NOTE 2: For Pre-established Sessions, the answered QoE Profile value corresponds to the QoE Profile assigned to the Pre-established Session; For On-demand Sessions, the QoE Profile assigned to the PoC Session is the one in the received SDP answer.

When composing an SDP answer, the PoC Server:

- 1. SHALL bind the media-level section that identifies PoC Speech to the corresponding Media-floor Control Entity as in the received SDP offer, if PoC Speech is accepted;
- 2. SHALL bind the media-level section that identifies Video to the corresponding Media-floor Control Entity as in the received SDP offer, if Video is accepted;
- 3. SHALL bind the media-level section that identifies Audio to the corresponding Media-floor Control Entity as in the received SDP offer, if Audio is accepted; and,
- 4. SHALL bind the media-level section that identifies Discrete Media to the corresponding Media-floor Control Entity as in the received SDP offer, if Discrete Media is accepted and bound to the Media-floor Control Entity.

When the SIP/IP Core corresponds with 3GPP/3GPP2 IMS, the PoC Server SHALL use 3GPP/3GPP2 IMS mechanisms according to rules and procedures of [3GPP TS 24.229] / [3GPP2 X.S0013.4] with the clarifications given in this subclause.

7.3.1.2 Pre-established Session

Upon receiving an initial SIP INVITE request that includes a Conference-factory-URI in the Request-URI but no invited member(s), the PoC Server performing the Participating PoC Function:

- 1. MAY reject the SIP INVITE request with a SIP 503 "Service Unavailable" response depending on the value of the requested QoE Profile if QoE Profiles are enabled and a risk of congestion exists as specified in [OMA-PoC-UP] "*Procedures at the PoC Server performing the Participating PoC Function*". The PoC Server MAY include a Retry-After header to the 503 "Service Unavailable" response as specified in [RFC3261];

NOTE 1: The PoC Client is allowed to re-attempt the PoC Session establishment after the time defined by the Retry-After header.

- 2. SHALL return a SIP 403 "Forbidden" response with the warning text set to '121 Function not allowed due to <detailed reason>' as specified in subclause 5.6 "*Warning header*", if the PoC Server does not support Pre-established Session. Otherwise, continue with the rest of the steps;

NOTE 2: Pre-established Session is an optional function; hence, the above condition is for the case where the PoC Server does not support this optional function.

- 3. SHALL check whether the Conference-factory-URI is allocated and perform the actions specified in subclause 7.5.1 "*Conference-factory URI does not exist*" if it is not allocated. Otherwise, continue with the rest of the steps;

- 4. SHALL perform actions to verify the Authenticated Originator's PoC Address of the PoC Client and authorize the request according to local policy, and if not authorized, the PoC Server SHALL return a SIP 403 "Forbidden" response with the warning text set to '121 Function not allowed due to <detailed reason>' as specified in subclause 5.6 "Warning header". Otherwise, continue with the rest of the steps;
- 5. SHALL validate that there is at least one Media Stream for which the Media Parameters and at least one codec offered in the SIP INVITE request are acceptable by the PoC Server and if not reject the request with a SIP 488 "Not Acceptable Here" response. Otherwise, continue with the rest of the steps;
- 6. SHALL allocate a URI to be used as a conference URI that identifies the Pre-established Session;
- 7. SHALL cache the Nick Name contained in the Authenticated Originator's PoC Address as specified in subclause 5.4 "Nick Name";
- 8. SHALL check if a Resource-Priority header is included in the SIP INVITE request according to rules and procedures of [RFC4412], if the 'Official Government Use' QoE Profile is supported. If included the PoC Server SHALL:
 - a) perform actions to authorize the Resource-Priority header, as specified in subclause 5.8 "QoE Profiles". If the Resource-Priority header cannot be authorized, the PoC Server SHALL reject the request with a SIP 403 "Forbidden" response with the warning text set to '115 <RequestedQoE> QoE Profile not authorized' as specified in subclause 5.6 "Warning header";
 - b) check that the QoE Profile attribute contained in the SDP offer indicates 'Official Government Use' QoE Profile, as specified in subclause E.3.2 "QoE Profile". If the QoE Profile attribute indicates other QoE Profile, the PoC Server SHALL reject the request with a SIP 403 "Forbidden" response with the warning text set to '114 QoE Assignment Error' as specified in subclause 5.6 "Warning header";
 - c) assign and cache 'Official Government Use' as the QoE Profile for the Pre-established Session; and,
 - d) apply preferential treatment to the SIP request, as specified in [RFC4412], skip the next step and proceed with the rest of the steps;
- 9. SHALL perform actions to authorize a QoE Profile attribute included in the received SDP offer, as specified in subclause 5.8 "QoE Profiles", if QoE Profiles are enabled and a QoE Profile attribute is included in the received SDP offer. The PoC Server SHALL:
 - a) assign and cache the requested QoE Profile as the QoE Profile for the Pre-established Session if the requested QoE Profile is authorized; or,
 - b) return a SIP 403 "Forbidden" response with the warning text set to '115 <RequestedQoE> QoE Profile not authorized' as specified in subclause 5.6 "Warning header" if the requested QoE Profile cannot be authorized. Otherwise continue with the rest of steps.

NOTE 3: If QoE Profiles are enabled but no QoE Profile attribute is included, it means that Basic QoE Profile is implicitly requested and therefore is always authorized.

- 10. SHALL check whether the Contact header includes the PoC Discrete Media feature '+g.poc.discretedia'. If it is present, the PoC Server SHALL cache the presence of the PoC Discrete Media feature tag.
- 11. SHALL check whether the Contact header includes the PoC Dispatcher feature '+g.poc.dispatcher', in case the PoC Dispatcher functionality is supported. If it is present, the PoC Server SHALL cache the presence of the PoC Dispatcher feature tag.
- 12. SHALL generate a SIP 200 "OK" response to the SIP INVITE request as follows:
 - a) include a Contact header containing the conference URI that identifies the Pre-established Session along with the PoC feature tag '+g.poc.talkburst' and the feature tag 'isfocus'. The PoC Server SHALL also include the PoC Dispatcher feature tag '+g.poc.dispatcher' in the Contact header, if it was included by the PoC Client in the Contact header of the initial SIP INVITE request.;
 - b) include an Allow header with the SIP methods supported in this SIP dialog according to rules and procedures of [RFC3261];
 - c) include a Server header to indicate the OMA PoC release version of the PoC Server as specified in subclause E.4.1 "Release version in User-agent and Server headers";
 - d) include the option tag 'timer' in a Require header;
 - e) include a Session-Expires header according to rules and procedures of [RFC4028], "UAS Behavior". The "refresher" parameter in the Session-Expires header SHALL be set to 'uac';

- f) include the Conference-factory-URI in the Authenticated Originator's PoC Address as specified in the subclause 5.2 "*Authenticated Originator's PoC Address*"; and,
- g) include a MIME SDP body as an SDP answer as specified in the subclause 7.3.1.1c "*SDP answer generation*";
- 13. SHALL interact with the User Plane as specified in [OMA-PoC-UP] "*Pre-established Session state diagrams – basic*";

NOTE 4: Resulting User Plane processing is completed before the next step is performed.

- 14. SHALL send the SIP 200 "OK" response towards the PoC Client according to the rules and procedures of the SIP/IP Core; and,
- 15. SHALL start the SIP Session timer using the value received in the Session-Expires header according to rules and procedures of [RFC4028].

When the SIP/IP Core corresponds with 3GPP/3GPP2 IMS, the PoC Server SHALL use 3GPP/3GPP2 IMS Session establishment mechanisms according to rules and procedures of [3GPP TS 24.229] / [3GPP2 X.S0013.4] with the clarifications given in this subclause.

7.3.1.3 Pre-established Session modification

This subclause describes the procedures for the Participating PoC Server upon receiving a SIP UPDATE request or a SIP re-INVITE request that modifies the Pre-established Session without associated PoC Session.

Upon receiving a SIP UPDATE request or a SIP re-INVITE request to modify an existing Pre-established Session without associated PoC Session, the PoC Server:

- 1. SHALL validate that the received SDP offer includes at least one Media Stream for which the Media Parameters and at least one codec or Media format is acceptable by the PoC Server and if not reject the request with a SIP 488 "Not Acceptable Here" response. Otherwise, continue with the rest of the steps;
- 2. SHALL check whether the Contact header includes the PoC Discrete Media feature tag '+g.poc.discretemedia'. If it is present, the PoC Server SHALL cache the presence of the PoC Discrete Media feature tag.
- 3. SHALL check if a Resource-Priority header is included in the SIP UPDATE or SIP re-INVITE request according to the rules and procedures of [RFC4412], if the 'Official Government Use' QoE Profile is supported. If included the PoC Server SHALL:
 - a) perform actions to authorize the Resource-Priority header, as specified in subclause 5.8 "*QoE Profiles*". If the Resource-Priority header cannot be authorized, the PoC Server SHALL reject the request with a SIP 403 "Forbidden" response with the warning text set to '115 <RequestedQoE> QoE Profile not authorized' as specified in subclause 5.6 "*Warning header*";
 - b) check that the QoE Profile attribute contained in the SDP offer indicates 'Official Government Use' QoE Profile, as specified in subclause E.3.2 "*QoE Profile*". If the QoE Profile attribute indicates other QoE Profile, the PoC Server SHALL reject the request with a SIP 403 "Forbidden" response with the warning text set to '114 QoE Assignment Error' as specified in subclause 5.6 "*Warning header*";
 - c) assign and cache 'Official Government Use' as the QoE Profile for the Pre-established Session; and,
 - d) apply preferential treatment to the SIP request, as specified in [RFC4412], skip the next step and proceed with the rest of the steps;
- 4. SHALL perform actions to authorize a QoE Profile attribute included in the PoC Client SDP offer, as specified in subclause 5.8 "*QoE Profiles*", if QoE Profiles are enabled and a QoE Profile attribute is included in the PoC Client SDP offer. The PoC Server SHALL:
 - a) assign and cache the requested QoE Profile as the QoE Profile for the Pre-established Session if the requested QoE Profile is authorized; or,
 - b) return a SIP 403 "Forbidden" response with the warning text set to '115 <RequestedQoE> QoE Profile not authorized' as specified in subclause 5.6 "*Warning header*" if the requested QoE Profile cannot be authorized. Otherwise continue with the rest of the steps.

- 5. SHALL interact with the User Plane as specified in [OMA-PoC-UP] "*Participating PoC Function procedures when connecting to a Media Type*", if the Media Stream, which is marked removed in the received SDP offer, is currently used in the Pre-established Session;
- 6. SHALL interact with the User Plane as specified in [OMA-PoC-UP] "*Participating PoC Function procedures when disconnecting from a Media Type*", if the received SDP offer includes a Media Stream, which is currently not used in the Pre-established Session,
- 7. SHALL interact with the User Plane as specified in [OMA-PoC-UP] "*User Plane adaptation*", if the received SDP offer includes changes in codecs, Media formats or Media Parameters compared to those currently used in the Pre-established Session; and,
- 8. SHALL generate a SIP 200 "OK" response as follows:
 - a) include a MIME SDP body as an SDP answer based on the received SDP offer as specified in the subclause 7.3.1.1c "*SDP answer generation*"; and,
 - b) include a Contact header containing the conference URI that identifies the Pre-established Session and send a SIP 200 "OK" response to the SIP/IP Core along the signalling path.

When the SIP/IP Core corresponds with 3GPP/3GPP2 IMS, the PoC Server SHALL use 3GPP/3GPP2 IMS mechanisms according to rules and procedures of [3GPP TS 24.229] / [3GPP2 X.S0013.4] with the clarifications given in this subclause.

7.3.1.4 PoC Session establishment or rejoin using On-demand Session

Upon receiving an initial SIP INVITE request containing a Request-URI with a Conference-Factory-URI owned by this PoC Server, the PoC Server:

NOTE 1: The procedure as follows applies when a PoC Client initiates an Ad-hoc PoC Group Session or a 1-1 PoC Session. The PoC Session will be owned by this same PoC Server.

- 1. MAY reject the SIP INVITE request with a SIP 503 "Service Unavailable" response depending on the value of the requested QoE Profile if QoE Profiles are enabled and a risk of congestion exists as specified in [OMA-PoC-UP] "*Procedures at the PoC Server performing the Participating PoC Function*". The PoC Server MAY include a Retry-After header to the 503 "Service Unavailable" response as specified in [RFC3261];

NOTE 2: The PoC Client is allowed to re-attempt the PoC Session establishment after the time defined by the Retry-After header.

- 2. SHALL authorize according to local policy whether the Served PoC User indicated by the Authenticated Originator's PoC Address is entitled to request manual answer override, if a Priv-Answer-Mode header with the value 'Auto' is present in the incoming SIP INVITE request and if not authorized or if manual answer override is not supported the PoC Server SHALL return a SIP 403 "Forbidden" response with the warning text set to '121 Function not allowed due to <detailed reason>' as specified in subclause 5.6 "*Warning header*". Otherwise continue with the rest of the steps;
- 3. SHALL check the total size of text content in the Subject header, if Included Text Content is supported by the PoC Server and if Subject header is included, and if the total size exceeds a configurable max size remove the text content;
- 4. SHALL perform the following actions, if Included Media Content is supported by the PoC Server and if media content is included in one or more MIME body:
 - a) authorize the Media Type of the media content in all MIME bodies using a Service Provider configurable setting and if at least one Media Type is not allowed send a SIP 415 "Unsupported Media Type", The SIP 415 "Unsupported Media Type" response SHALL include:
 - i. the Accept header with the acceptable Media Types that the PoC Server would accept according to rules and procedures of [RFC3261]; or,
 - ii. the Accept-Encoding header with the encoding formats that the PoC Server would accept according to rules and procedures of [RFC3261]; or,
 - iii. both

and do not continue with the rest of the steps.

- b) Check the total size of all MIME bodies containing media content and if the total size exceeds a configurable max size, based on a Service Provider Policy either,
 - i. send a SIP 413 "Request Entity Too Large" response and do not continue with the rest of the steps; or,
 - ii. remove all MIME bodies containing media content.
- 5. SHALL check if a Resource-Priority header is included in the SIP INVITE request according to rules and procedures of [RFC4412], if the 'Official Government Use' QoE Profile is supported. If included the PoC Server SHALL:
 - a) perform actions to authorize the Resource-Priority header, as specified in subclause 5.8 "*QoE Profiles*". If the Resource-Priority header cannot be authorized, the PoC Server SHALL reject the request with a SIP 403 "Forbidden" response with the warning text set to '115 <RequestedQoE> QoE Profile not authorized' as specified in subclause 5.6 "*Warning header*";
 - b) check that the QoE Profile attribute contained in the SDP offer indicates 'Official Government Use' QoE Profile, as specified in subclause E.3.2 "*QoE Profile*". If the QoE Profile attribute indicates other QoE Profile, the PoC Server SHALL reject the request with a SIP 403 "Forbidden" with the warning text set to '114 QoE Assignment Error' as specified in subclause 5.6 "*Warning header*";
 - c) cache 'Official Government Use' as the Local QoE Profile assigned to the PoC User; and,
 - d) apply preferential treatment to the SIP request, as specified in [RFC4412], skip the next step and proceed with the rest of the steps;
- 6. SHALL perform actions to authorize a QoE Profile attribute included in the PoC Client SDP offer, as specified in subclause 5.8 "*QoE Profiles*", if QoE Profiles are enabled and a QoE Profile attribute is included in the PoC Client SDP offer. The PoC Server SHALL:
 - a) cache the requested QoE Profile as the Local QoE Profile assigned to the PoC User if the requested QoE Profile is authorized and the PoC Server is acting as a B2BUA; or,
 - b) return a SIP 403 "Forbidden" response with the warning text set to '115 <RequestedQoE> QoE Profile not authorized' as specified in subclause 5.6 "*Warning header*" if the requested QoE Profile cannot be authorized. Otherwise continue with the rest of steps.
- 7. MAY remove the Subject header;
- 8. MAY remove the Alert-Info or the Call-Info header or both;

NOTE 3: The reason for removing the Alert-Info header or the Call-Info header may be a local policy in the PoC Server.

- 9. SHALL check if the number of maximum Simultaneous PoC Sessions for the PoC Client has exceeded, if the PoC Service Settings for the Simultaneous PoC Sessions Support is set to "SSS active". If exceeded, the PoC Server SHALL respond with a SIP 486 "Busy Here" response with the warning text set to '104 Too many Simultaneous PoC Sessions' as specified in subclause 5.6 "*Warning header*". Otherwise, continue with the rest of the steps; and,
- 10. SHALL also adapt the role of a Controlling PoC Function and continue as specified in the subclause 7.2.1.2 "*Ad-hoc PoC Group and 1-1 PoC Session setup request*".

NOTE 4: The handling of SIP requests and SIP responses within the SIP dialog created by this SIP INVITE request is described in the 7.2.1.2 "*Ad-hoc PoC Group and 1-1 PoC Session setup request*".

Upon receiving an initial SIP INVITE request that contains a Request-URI not owned by this PoC Server, the PoC Server:

NOTE 5: The following procedure of this subclause applies when a PoC Client initiates or joins a Pre-arranged PoC Group Session, or when a PoC Client rejoins a PoC Session, or when a PoC Client joins a Chat PoC Group Session and in all these cases the PoC Session is owned by another PoC Server.

either

- 1. MAY reject the SIP INVITE request with a SIP 503 "Service Unavailable" response depending on the value of the requested QoE Profile if QoE Profiles are enabled and a risk of congestion exists as specified in [OMA-PoC-UP] "*Procedures at the PoC Server performing the Participating PoC Function*". The PoC Server MAY include a Retry-After header to the 503 "Service Unavailable" response as specified in [RFC3261];

NOTE 6: The PoC Client is allowed to re-attempt the PoC Session establishment after the time defined by the Retry-After header.

- 2. SHALL perform actions to verify the Authenticated Originator's PoC Address of the Inviting PoC User and authorize the request according to local policy and if not authorized the PoC Server SHALL return a SIP 403 "Forbidden" response with the warning text set to '121 Function not allowed due to <detailed reason>' as specified in subclause 5.6 "Warning header". Otherwise, continue with the rest of the steps;
- 3. SHALL validate that the new Media Parameters and at least one codec offered in the SIP INVITE request are acceptable by the PoC Server when staying on the Media path and if not reject the request with a SIP 488 "Not Acceptable Here" response. Otherwise, continue with the rest of the steps;
- 4. SHALL behave as a B2BUA according to rules and procedures of [RFC3261] for the duration of the PoC Session, when staying on the Media path;
- 5. SHALL authorize according to local policy whether the served PoC User indicated by the Authenticated Originator's PoC Address is entitled to request manual answer override, if a Priv-Answer-Mode header with the value 'Auto' is present in the incoming SIP INVITE request and if not authorized or if manual answer override is not supported the PoC Server SHALL return a SIP 403 "Forbidden" response with the warning text set to '121 Function not allowed due to <detailed reason>' as specified in subclause 5.6 "Warning header". Otherwise continue with the rest of the steps;
- 6. SHALL check if the number of maximum Simultaneous PoC Sessions for the PoC Client has exceeded, if the PoC Service Settings for the Simultaneous PoC Sessions Support is set to "SSS active". If exceeded, the PoC Server SHALL respond with a SIP 486 "Busy Here" response with the warning text set to '104 Too many Simultaneous PoC Sessions' as specified in subclause 5.6 "Warning header". Otherwise, continue with the rest of the steps;
- 7. SHALL check the total size of text content in the Subject header, if Included Text Content is supported by the PoC Server and if Subject header is included, and if the total size exceeds a configurable max size remove the text content;
- 8. SHALL perform the following actions, if Included Media Content is supported by the PoC Server and if media content is included in one or more MIME body:
 - a) authorize the Media Type of the media content in all MIME bodies using a Service Provider configurable setting and if at least one Media Type is not allowed send a SIP 415 "Unsupported Media Type", the SIP 415 "Unsupprted Media Type" response SHALL include:
 - i. the Accept header with the acceptable Media Types that the PoC Server would accept according to rules and procedures of [RFC3261]; or,
 - ii. the Accept-Encoding header with the encoding formats that the PoC Server would accept according to rules and procedures of [RFC3261]; or,
 - iii. both
 - and do not continue with the rest of the steps.
 - b) Check the total size of all MIME bodies containing media content and if the total size exceeds a configurable max size, based on a Service Provider policy either,
 - i. send a SIP 413 "Request Entity Too Large" response and do not continue with the rest of the steps; or,
 - ii. remove all MIME bodies containing media content.
- 9. SHALL check if a Resource-Priority header is included in the SIP INVITE request according to rules and procedures of [RFC4412], if the 'Official Government Use' QoE Profile is supported. If included the PoC Server SHALL:
 - a) perform actions to authorize the Resource-Priority header, as specified in subclause 5.8 "QoE Profiles". If the Resource-Priority header cannot be authorized, the PoC Server SHALL reject the request with a SIP 403 "Forbidden" response with the warning text set to '115 <RequestedQoE> QoE Profile not authorized' as specified in subclause 5.6 "Warning header";
 - b) check that the QoE Profile attribute contained in the SDP offer indicates 'Official Government Use' QoE Profile, as specified in subclause E.3.2 "QoE Profile". If the QoE Profile attribute indicates other QoE Profile, the PoC Server SHALL reject the request with a SIP 403 "Forbidden" response with the warning text set to '114 QoE Assignment Error' as specified in subclause 5.6 "Warning header";
 - c) cache 'Official Government Use' as the Local QoE Profile assigned to the PoC User; and,

- d) apply preferential treatment to the SIP request, as specified in [RFC4412], skip the next step and proceed with the rest of the steps;
- 10. SHALL perform actions to authorize the QoE Profile attribute included in the PoC Client SDP offer, as specified in subclause 5.8 "*QoE Profiles*", if QoE Profiles are enabled and a QoE Profile attribute is included in the PoC Client SDP offer. The PoC Server SHALL:
 - a) cache the authorized QoE Profile as the Local QoE Profile assigned to the PoC User if the requested QoE Profile is authorized; or,
 - b) return a SIP 403 "Forbidden" response with the warning text set to '115 <RequestedQoE> QoE Profile not authorized' as specified in subclause 5.6 "*Warning header*" if the requested QoE Profile cannot be authorized. Otherwise continue with the rest of steps.
- 11. MAY remove the Subject header;
- 12. MAY remove the Alert-Info or the Call-Info header or both;

NOTE 7: The reason for removing the Alert-Info header or the Call-Info header may be a local policy in the PoC Server.

- 13. SHALL generate a SIP INVITE request as specified in subclause 7.3.1.1 "*General*";
- 14. SHALL include as the contents of the Request-URI:
 - a) copy the received Request-URI including the Session Type uri-parameter and any other uri-parameter present in the received Request-URI; or,
 - b) resolve back the received Request-URI to the SIP URI received in the Contact header from the PoC Server performing the Controlling PoC Function within the SIP 200 "OK" response to the initial SIP INVITE request in the case of re-join.
- 15. SHALL include in the SIP INVITE request a MIME SDP body as an SDP offer based on the SDP offer in the received SIP INVITE request from the PoC Client as specified in the subclause 7.3.1.1a "*SDP offer generation in case of On-demand session*";
- 16. SHALL include the MIME bodies in the incoming SIP INVITE request into the outgoing SIP INVITE request as specified in [RFC2046], if Included Media Content is supported by the PoC Server and if media content is included in one or more MIME body;
- 17. SHALL include a Resource-Priority header according to rules and procedures of [RFC4412] set to the value indicated in the Resource-Priority header of the SIP INVITE request from the PoC Client, if the 'Official Government Use' QoE Profile is supported and if a Resource-Priority header was present in the SIP INVITE request from the PoC Client;
- 18. SHALL include the Subject header received in the incoming SIP INVITE request into the outgoing SIP INVITE request, if Text Content is supported by the PoC Server and if text content is included in Subject header;
- 19. SHALL include the Alert-Info header and Call-Info header received in the incoming SIP INVITE request into the outgoing SIP INVITE request, if Referenced Media Content is supported by the PoC Server and if a reference to media content is included in Alert-Info header or Call-Info header or both; and,

NOTE 8: The '+g.poc.interworking' is included in a SIP INVITE by the PoC Interworking Agent, behaving like a PoC Client on behalf of a PoC Remote Access User.

- 20. SHALL send the SIP INVITE request towards the PoC Server performing the Controlling PoC Function according to rules and procedures of the SIP/IP Core.

or

- 1. SHALL act as a SIP proxy according to rules and procedures of [RFC3261] for the duration of the PoC Session, when not staying in media and Talk Burst Control path;
- 2. SHALL check the total size of text content in the Subject header, if Included Text Content is supported by the PoC Server and if Subject header is included, and if the total size exceeds a configurable max size remove the text content;
- 3. SHALL perform the following actions, if Included Media Content, or Text Content, or Referenced Media Content is supported by the PoC Server and if media content is included in one or more MIME body:

- a) authorize the Media Type of the media content in all MIME bodies, or Subject header, or Alert-Info header using a Service Provider configurable setting and if at least one Media Type is not allowed send a SIP 415 "Unsupported Media Type". The SIP 415 "Unsupported Media Type" response SHALL include:
 - i. the Accept header with the acceptable Media Types that the PoC Server would accept according to rules and procedures of [RFC3261]; or,
 - ii. the Accept-Encoding header with the encoding formats that the PoC Server would accept according to rules and procedures of [RFC3261]; or,
 - iii. both.
- and do not continue with the rest of the steps.
- b) Check the total size of all the MIME bodies containing media content and if the total size exceeds a configurable max size, based on a Service Provider Policy either,
 - i. send a SIP 413 "Request Entity Too Large" response and do not continue with the rest of the steps; or,
 - ii. remove all MIME bodies containing media content.
- 4. SHALL check if a Resource-Priority header is included in the SIP INVITE request according to rules and procedures of [RFC4412], if the 'Official Government Use' QoE Profile is supported. If included the PoC Server SHALL:
 - a) perform actions to authorize the Resource-Priority header, as specified in subclause 5.8 "*QoE Profiles*". If the Resource-Priority header cannot be authorized, the PoC Server SHALL reject the request with a SIP 403 "Forbidden" response with the warning text set to '115 <RequestedQoE> QoE Profile not authorized' as specified in subclause 5.6 "*Warning header*";
 - b) check that the QoE Profile attribute contained in the SDP offer indicates 'Official Government Use' QoE Profile, as specified in subclause E.3.2 "*QoE Profile*". If the QoE Profile attribute indicates other QoE Profile, the PoC Server SHALL reject the request with a SIP 403 "Forbidden" response with the warning text set to '115 <RequestedQoE> QoE Profile not authorized' as specified in subclause 5.6 "*Warning header*". Otherwise proceed with the rest of the steps; and,
 - c) apply preferential treatment to the SIP request, as specified in [RFC4412], skip the next step and proceed with the rest of the steps.
- 5. SHALL perform actions to authorize the QoE Profile attribute included in the PoC Client SDP offer, as specified in subclause 5.8 "*QoE Profiles*", if QoE Profiles are enabled and a QoE Profile attribute is included in the PoC Client SDP offer. The PoC Server SHALL:
 - a) return a SIP 403 "Forbidden" response with the warning text set to '115 <RequestedQoE> QoE Profile not authorized' as specified in subclause 5.6 "*Warning header*" if the requested QoE Profile cannot be authorized. Otherwise continue with the rest of steps.
- 6. SHALL include a Record-Route header containing a URI identifying its own address; and,
- 7. SHALL forward the SIP INVITE request towards the PoC Server performing the Controlling PoC Function.

Upon receiving a SIP 180 "Ringing" response and when the PoC Server is acting as a B2BUA, the PoC Server:

- 1. SHALL cache the list of supported SIP methods if received in the Allow header;
- 2. SHALL cache the contact if received in the Contact header;
- 3. SHALL generate a SIP 180 "Ringing" response to the SIP INVITE request as specified in the subclause 7.3.1.1 "*General*";
- 4. SHALL include Warning header(s) received in incoming SIP 180 "Ringing" response; and,
- 5. SHALL forward the SIP 180 "Ringing" response to the PoC Client according to rules and procedures of the SIP/IP Core.

Upon receiving a SIP 180 "Ringing" response and when the PoC Server is acting as a SIP proxy the PoC Server SHALL forward the SIP response towards the initiating PoC Client according to rules and procedures of [RFC3261].

Upon receiving a SIP 200 "OK" response, the PoC Server is acting as a B2BUA, the PoC Server:

- 1. SHALL cache the list of supported SIP methods if received in the Allow header;
- 2. SHALL cache the contact received in the Contact header;
- 3. SHALL generate a SIP 200 "OK" response as specified in the subclause 7.3.1.1 "*General*";

- 4. SHALL include in the SIP 200 "OK" response a MIME SDP body as an SDP answer as specified in the subclause 7.3.1.1c "*SDP answer generation*";
- 5. SHALL include unmodified a P-Answer-State header if a P-Answer-State header was present in the incoming SIP 200 "OK" response;
- 6. SHALL include Warning header(s) received in the incoming SIP 200 "OK" responses.
- 7. SHALL send the SIP 200 "OK" response to the PoC Client according to rules and procedures of SIP/IP Core; and
- 8. SHALL interact with User Plane as specified in [OMA-PoC-UP] "*Participating PoC Function procedures at PoC Session initialization*";

Upon receiving a SIP 200 "OK" response, when the PoC Server is acting as a SIP proxy

- 1. SHALL forward the SIP 200 "OK" response toward the initiating PoC Client according to rules and procedures of [RFC3261] and SIP/IP Core;
- 2. SHALL continue to act as a SIP proxy for the duration of the PoC Session.

Upon receiving a SIP final response other than a SIP 200 "OK", the PoC Server SHALL forward the SIP final response along the signalling path towards the initiating PoC Client.

When the SIP/IP Core corresponds with 3GPP/3GPP2 IMS, the PoC Client SHALL use 3GPP/3GPP2 IMS mechanisms according to rules and procedures of [3GPP TS 24.229] / [3GPP2 X.S0013.4] with the clarifications given in this subclause.

7.3.1.5 PoC Session initiation using Pre-established Session

Upon receiving a SIP REFER request containing in the Request-URI a SIP URI of a Pre-established Session owned by this PoC Server and if the "method" parameter in the Refer-to header is set as "INVITE" or is not present, the PoC Server:

- 1. SHALL check if the number of maximum Simultaneous PoC Sessions for the PoC Server has exceeded. If exceeded, the PoC Server SHALL respond with a SIP 486 "Busy Here" response with the warning text set to '104 Too many Simultaneous PoC Sessions' as specified in subclause 5.6 "*Warning header*". Otherwise, continue with the rest of the steps;
- 2. SHALL check whether the Contact header includes the PoC Discrete Media feature tag '+g.poc.discretedia'. If it is present, and if the Pre-established Session does not include the PoC Discrete Media feature tag '+g.poc.discretedia', the PoC Server SHALL reject the incoming SIP INVITE request with a SIP 403 "Forbidden" response and not continue with the rest of the steps;
- 3. SHALL authorize according to local policy whether the Served PoC User indicated by the Authenticated Originator's PoC Address is entitled to request manual answer override, if a Priv-Answer-Mode header with the value 'Auto' is present in the incoming SIP REFER request and if not authorized or if manual answer override is not supported the PoC Server SHALL return a SIP 403 "Forbidden" response with the warning text set to '121 Function not allowed due to <detailed reason>' as specified in subclause 5.6 "*Warning header*". Otherwise continue with the rest of the steps;
- 4. SHALL check the SIP URI in the Refer-To header. If the SIP URI in the Refer-To header does not include the Session Type uri-parameter "session=adhoc", "session=prearranged" or "session=chat" the PoC Server:
 - a) SHALL perform the procedures as specified in 7.2.1.8 "*Adding Participants to PoC Session Request*" and do not do anything else in this subclause.
- 5. SHALL behave as a B2BUA according to rules and procedures of [RFC3261] for the duration of the PoC Session;
- 6. SHALL generate a final SIP response 2xx according to rules and procedures of [RFC3515];
- 7. SHALL check the presence of the Refer-Sub header of the SIP REFER request and if it is present and it has the value 'false' then the PoC Server SHALL include in the response to the SIP REFER request a Refer-Sub header set to 'false' according to rules and procedures of [RFC4488];
- 8. SHALL check if a Resource-Priority header is included in the SIP REFER request according to rules and procedures of [RFC4412], if the 'Official Government Use' QoE Profile is supported. If included the PoC Server SHALL:
 - a) perform actions to authorize the Resource-Priority header, as specified in subclause 5.8 "*QoE Profiles*". If the Resource-Priority header cannot be authorized, the PoC Server SHALL reject the request with a SIP 403

"Forbidden" response with the warning text set to '115 <RequestedQoE> QoE Profile not authorized' as specified in subclause 5.6 "Warning header";

b) check that the QoE Profile assigned to the Pre-established session is 'Official Government Use' QoE Profile, as specified in subclause E.3.2 "QoE Profile". If the QoE Profile assigned to the Pre-established session is other QoE Profile, the PoC Server SHALL reject the request with a SIP 403 "Forbidden" response with the warning text set to '115 <RequestedQoE> QoE Profile not authorized' as specified in subclause 5.6 "Warning header"; and,

c) apply preferential treatment to the SIP request, as specified in [RFC4412], and proceed with the rest of the steps.

- 9. MAY remove the Subject header from the URI of the Refer-To header;
- 10. MAY remove the Alert-Info or the Call-Info header or both from the URI of the Refer-To header;
- 11. SHALL send the SIP response to the SIP REFER request towards the PoC Client according to rules and procedures of the SIP/IP Core;
- 12. SHALL generate a SIP INVITE request as specified in subclause 7.3.1.1 "General";
- 13. SHALL insert a Request-URI using the URI, and possible Session Type and Dispatch Type uri-parameters, out of the Refer-To in the SIP REFER request;
- 14. SHALL include a Resource-Priority header according to rules and procedures of [RFC4412] set to the value negotiated during the Pre-established Session establishment, if the 'Official Government Use QoE Profile' is supported and if this is the QoE Profile assigned to the Pre-established Session;
- 15. SHALL include in the SIP INVITE request a MIME SDP body as an SDP offer as specified in the subclause 7.3.1.1b "SDP offer generation in case of Pre-established Session" based on the SDP negotiated during the Pre-established Session establishment as specified subclause 7.3.1.2 "Pre-established Session";
- 16. SHALL include the Subject header into the outgoing SIP INVITE request, if received in the URI of Refer-To header of the incoming SIP REFER request and if Text Content is supported by the PoC Server;
- 17. SHALL include the Alert-Info header, Call-Info header or both into the outgoing SIP INVITE request, if received in the URI of the Refer-To header of the incoming SIP REFER request and if Referenced Media Content is supported by the PoC Server;
- 18. SHALL include the media content in MIME body into the outgoing SIP INVITE request, if received media content in MIME body of the SIP REFER request and Included Media Content is supported by the PoC Server;
- 19. SHALL send the SIP INVITE request towards the PoC Server performing the Controlling PoC Function according to rules and procedures of the SIP/IP Core; and,

NOTE: B2BUA do not forward any SIP provisional nor final responses.

- 20. SHALL generate and send to the PoC Client SIP NOTIFY request(s) as specified in the subclause 7.2.1.17 "Generating a SIP NOTIFY request to the SIP REFER request" based on the progress of the invitation, if the Refer-Sub header is not present or is set to 'true' in the SIP REFER request.

Upon receiving SIP provisional responses for the SIP INVITE request(s) the PoC Server:

- 1. SHALL cache the list of supported SIP methods if received in the Allow header;
- 2. SHALL cache the contact if received in the Contact header; and,
- 3. SHALL discard the received SIP responses without forwarding them.

Upon receiving a SIP 200 "OK" response for the SIP INVITE request the PoC Server:

- 1. SHALL cache the list of supported SIP methods if received in the Allow header;
- 2. SHALL cache the contact received in the Contact header; and,
- 3. SHALL interact with the User Plane as specified in [OMA-PoC-UP] "Participating PoC Function procedures at PoC Session initialization", when a PoC Session is initiated;

Upon receiving a SIP 403 "Forbidden" response with the warning code 399 and the warning text '105 Isfocus already assigned', or a SIP 503 "Service Unavailable", or a SIP 486 "Busy Here", or a SIP 488 "Not Acceptable Here", or a SIP 417 "Unknown Resource Priority", the PoC Server SHALL generate and send to the PoC Client a SIP NOTIFY request as

specified in the subclause 7.2.1.17 "Generating a SIP NOTIFY request to the SIP REFER request", if the Refer-Sub header is not present or is set to 'true' in the SIP REFER request.

Upon receiving a SIP final response other than 2xx, 3xx, or a SIP response other than specifically mentioned above, the PoC Server:

- 1. SHALL discard the received SIP responses without forwarding them.

When the SIP/IP Core corresponds with 3GPP/3GPP2 IMS, the PoC Client SHALL use 3GPP/3GPP2 IMS mechanisms, according to rules and procedures of [3GPP TS 24.229] / [3GPP2 X.S0013.4] with the clarifications given in this subclause.

7.3.1.6 PoC Session modifications

Upon receiving a SIP UPDATE request or a SIP re-INVITE request from the PoC Client during an on-going PoC Session including a new SDP offer as specified by [RFC3264] and [RFC4566] a PoC Server acting as a B2BUA:

- 1. SHALL validate that the received SDP offer includes at least one Media Stream for which the Media Parameters and at least one codec or Media format is acceptable to the PoC Server and if not reject the request with a SIP 488 "Not Acceptable Here" response. Otherwise continue with the rest of the steps;
- 2. SHALL check if a Resource-Priority header is included in the SIP re-INVITE or SIP UPDATE request according to rules and procedures of [RFC4412], if the 'Official Government Use' QoE Profile is supported. If included the PoC Server SHALL:
 - a) perform actions to authorize the Resource-Priority header, as specified in subclause 5.8 "QoE Profiles". If the Resource-Priority header cannot be authorized, the PoC Server SHALL reject the request with a SIP 403 "Forbidden" response with the warning text set to '115 <RequestedQoE> QoE Profile not authorized' as specified in subclause 5.6 "Warning header";
 - b) check that the QoE Profile attribute contained in the SDP offer indicates 'Official Government Use' QoE Profile, as specified in subclause E.3.2 "QoE Profile". If the QoE Profile attribute indicates other QoE Profile, the PoC Server SHALL reject the request with a SIP 403 "Forbidden" response with the warning text set to '114 QoE Assignment Error' as specified in subclause 5.6 "Warning header";
 - c) cache 'Official Government Use' as the Local QoE Profile assigned to the PoC User; and,
 - d) apply preferential treatment to the SIP request, as specified in [RFC4412], skip the next step and proceed with the rest of the steps.
- 3. SHALL perform actions to authorize a QoE Profile attribute included in the PoC Client SDP offer, as specified in subclause 5.8 "QoE Profiles", if QoE Profiles are enabled, a QoE Profile attribute is included in the received SDP offer and the value of the included QoE Profile attribute is different than the Local QoE Profile for the on-going PoC Session. The PoC Server SHALL:
 - a) cache the requested QoE Profile as the Local QoE Profile assigned to the PoC User if the requested QoE Profile is authorized; or,
 - b) return a SIP 403 "Forbidden" response with the warning text set to '115 <RequestedQoE> QoE Profile not authorized' as specified in subclause 5.6 "Warning header" if the requested QoE Profile cannot be authorized. Otherwise continue with the rest of steps.
- 4. MAY generate a SIP UPDATE request according to rules and procedures of [RFC3311], if the PoC Server supports the SIP UPDATE request and if
 - a) the PoC Server performing the Controlling PoC Function has indicated support for the SIP UPDATE method;
 - b) the offered Media Streams and the offered Media-floor Control Entities are used in the PoC Session by the PoC Client; and,
 - c) the offered Media-floor Control Entity binding of each Media Stream used and offered is the same as used; and SHALL generate a SIP re-INVITE request according to rules and procedures of [RFC3261], if the SIP UPDATE request is not generated.
- 5. SHALL include in the SIP request a MIME SDP body as an SDP offer as specified in subclause 7.3.1.1a "SDP offer generation in case of On-demand session";
- 6. SHALL include a Resource-Priority header according to the rules and procedures of [RFC4412], set to the value included in the received SIP re-INVITE or SIP UPDATE request, if the 'Official Government Use' QoE Profile is

supported and if an authorized Resource-Priority header was included in the received SIP re-INVITE or SIP UPDATE request; and,

- 7. SHALL send the SIP request towards the PoC Server performing the Controlling PoC Function within the existing SIP dialog according to rules and procedures of the SIP/IP Core.

Upon receiving a SIP 200 "OK" response the PoC Server:

- 1. SHALL generate a SIP 200 "OK" response to the SIP UPDATE request and SIP re-INVITE according to rules and procedures of [RFC3261];
- 2. SHALL include a MIME SDP body in the SIP 200 "OK" response as the SDP answer according to rules and procedures of [RFC3264] and [RFC2327] with the new Media Parameters;
- 3. SHALL interact with the User Plane as specified in [OMA-PoC-UP] "*User Plane adaptation*" for updating the User Plane with the newly negotiated codecs and Media Parameters from the received SDP answer, if the PoC Server is in the Media path and if the received SDP answer includes changes in codecs or Media formats or Media Parameters from those earlier accepted;
- 4. SHALL interact with the User Plane as specified in [OMA-PoC-UP] "*Participating PoC Function procedures when disconnecting from a Media*", if the PoC Server is in the Media path and if a Media Stream previously used in the PoC Session was marked as rejected in the received SDP answer or if the current Media-floor Control Entity binding of a Media, that is currently used in the PoC Session and accepted in the SDP answer, is not the same as in the received SDP answer;
- 5. SHALL interact with the User Plane as specified in [OMA-PoC-UP] "*Participating PoC Function procedures when connecting to a Media*", if the PoC Server is in the Media path and if a Media Stream not previously used in the PoC Session was accepted in the received SDP answer or if the current Media-floor Control Entity binding of a Media, that is currently used in the PoC Session and accepted in the SDP answer, is not the same as in the received SDP answer; and;
- 6. SHALL include the PoC Session Identity in a Contact header when the On-demand Session is used and include conference URI which identifies Pre-established Session when the Pre-established Session is used;
- 7. SHALL send a SIP 200 "OK" response towards the PoC Client according to rules and procedures of SIP/IP Core.

NOTE 1: In case the Media Streams, the codecs, the Media formats or the Media Parameters have been re-negotiated for the PoC Session established within Pre-established Session, they are valid in the Pre-established Session also after the PoC Session is released.

Upon receiving a SIP UPDATE request or a SIP re-INVITE request from the PoC Client during an on-going PoC Session a PoC Server acting as a SIP proxy SHALL act according to rules and procedures of [RFC3261] and [RFC 4412].

NOTE 2: Per [RFC 4412] a PoC Server acting as a SIP proxy authorizes a Resource-Priority header included in a SIP request, and can reject a SIP request with an unauthorized Resource-Priority header.

Upon receiving SIP final response other than SIP 200 "OK" the PoC Server SHALL forward the SIP response to the PoC Client according to rules and procedures of SIP/IP Core.

When the SIP/IP Core corresponds with 3GPP/3GPP2 IMS, the PoC Server SHALL use 3GPP/3GPP2 IMS Session mechanisms according to rules and procedures of [3GPP TS 24.229] / [3GPP2 X.S0013.4] with the clarifications given in this subclause.

7.3.1.7 SIP SUBSCRIBE request

Upon receiving a SIP SUBSCRIBE request that contains a SIP URI corresponding to a PoC Session owned by this PoC Server the PoC Server:

- 1. SHOULD check if a Resource-Priority header is included in the SIP SUBSCRIBE request according to rules and procedures of [RFC4412], if the 'Official Government Use' QoE Profile is supported. If included the PoC Server SHALL:
 - a) perform actions to authorize the Resource-Priority header, as specified in subclause 5.8 "*QoE Profiles*". If the Resource-Priority header cannot be authorized, the PoC Server SHALL reject the request with a SIP 403

"Forbidden" response with the warning text set to '115 <RequestedQoE> QoE Profile not authorized' as specified in subclause 5.6 "Warning header"; and,

- b) apply preferential treatment to the SIP request, as specified in [RFC4412], and proceed with the rest of the steps;
- 2. SHALL perform the Controlling PoC Function as specified in subclause 7.2.1.11.1 "*Subscribing to Participant information*".

If the PoC Server receives a SIP SUBSCRIBE request that contains a PoC Session Identity or PoC Group Identity not owned by this PoC Server, the PoC Server:

- 1. SHALL insert a Record-Route header containing a URI identifying its own address, if the PoC Server wants to stay on the signalling path;
- 2. SHALL insert a Request-URI by resolving back the received Request-URI to the SIP URI received in the Contact header from the PoC Server performing the Controlling PoC Function within the SIP 200 "OK" response to the initial SIP INVITE request, if the PoC Server is acting as a B2BUA for the PoC Session;
- 3. SHALL check if a Resource-Priority header is included in the SIP SUBSCRIBE request according to rules and procedures of [RFC4412], if the 'Official Government Use' QoE Profile is supported. If included the PoC Server SHALL:
 - a) perform actions to authorize the Resource-Priority header, as specified in subclause 5.8 "*QoE Profiles*". If the Resource-Priority header cannot be authorized, the PoC Server SHALL reject the request with a SIP 403 "Forbidden" response with the warning text set to '115 <RequestedQoE> QoE Profile not authorized' as specified in subclause 5.6 "Warning header";
 - b) include a Resource-Priority header set to the same value as the one received in the SIP SUBSCRIBE request received from the PoC Client; and,
 - c) apply preferential treatment to the SIP request, as specified in [RFC4412], and proceed with the rest of the steps.
- 4. SHALL forward the SIP SUBSCRIBE request towards the SIP/IP Core.

Upon receiving a SIP final response PoC Server SHALL forward the SIP final response along the signaling path towards the initiating PoC Client according to rules and procedures of [RFC3261].

When the SIP/IP Core corresponds with 3GPP/3GPP2 IMS, the PoC Server SHALL use 3GPP/3GPP2 IMS mechanisms according to rules and procedures of [3GPP TS 24.229] / [3GPP2 X.S0013.4] with the clarifications given in this subclause.

7.3.1.8 SIP REFER request received

Upon receiving a SIP REFER request containing in the Request-URI a conference URI that identifies a Pre-established Session owned by this PoC Server, the PoC Server:

- 1. SHALL perform the procedures specified in subclause 7.3.1.5 "*PoC Session Initiation using Pre-established Session*", if the "method" parameter in the Refer-to header is set as "INVITE" or is not present; or
- 2. SHALL perform the procedures specified in subclause 7.3.1.10.2 "*SIP REFER BYE request from the PoC Client - Pre-established Session case*", if the "method" parameter in the Refer-to header is set as "BYE".

Upon receiving a SIP REFER request containing in the Request-URI a SIP URI of a PoC Session not owned by this PoC Server, the PoC Server:

- 1. SHALL insert a Record-Route header containing its own address, if the PoC Server wants to stay on the signalling path; and,
- 2. SHALL forward the SIP REFER request towards the Controlling PoC Function according to rules and procedures of the SIP/IP Core.

Upon receiving a SIP final response to the SIP REFER request that the PoC Server forwarded, the PoC Server SHALL forward the SIP final response along the signaling path towards the initiating PoC Client according to rules and procedures of [RFC3261].

When the SIP/IP Core corresponds with 3GPP/3GPP2 IMS, the PoC Client SHALL use 3GPP/3GPP2 IMS mechanisms according to rules and procedures of [3GPP TS 24.229] / [3GPP2 X.S0013.4] with the clarifications given in this subclause.

7.3.1.9 SIP CANCEL request

Upon receiving a SIP CANCEL request from the PoC Client, a PoC Server acting as a B2BUA:

- 1. SHALL act as UAS according to rules and procedures of [RFC3261]; and,
- 2. SHALL cancel the SIP INVITE request towards the PoC Server performing the Controlling PoC Function acting as UAC according to rules and procedures of [RFC3261].

When acting as a SIP proxy the rules and procedures as specified in [RFC3261] SHALL be applied.

When the SIP/IP Core corresponds with 3GPP/3GPP2 IMS, the PoC Server SHALL use 3GPP/3GPP2 IMS mechanisms according to rules and procedures of [TS24.229] / [3GPP2 X.S0013.4] with the clarifications given in this subclause.

7.3.1.10 SIP BYE request from PoC Client

7.3.1.10.1 SIP BYE request from PoC Client – On-demand Session case

Upon receiving a SIP BYE request from the PoC Client the PoC Server acting as a B2BUA:

- 1. SHOULD check if a Resource-Priority header is included in the SIP BYE request according to rules and procedures of [RFC4412], if the 'Official Government Use' QoE Profile is supported. If included the PoC Server SHALL:
 - a) perform actions to authorize the Resource-Priority header, as specified in subclause 5.8 "QoE Profiles". If the Resource-Priority header cannot be authorized, the PoC Server SHALL skip step b and proceed with the rest of the steps; and,
 - b) apply preferential treatment to the SIP request, as specified in [RFC4412], and proceed with the rest of the steps.
- 2. SHALL generate a SIP 200 "OK" response and send it towards PoC Client according to rules and procedures of the SIP/IP Core;
- 3. SHALL interact with the User Plane as specified in [OMA-PoC-UP] "*Participating PoC Function procedures at PoC Session release*" for releasing User Plane resources associated with the SIP Session with the PoC Client;
- 4. SHALL generate a SIP BYE request;
- 5. SHALL include a Resource-Priority header, according to rules and procedures of [RFC4412] set to the same value as the one received in the SIP BYE request, if the PoC Server supports 'Official Government Use' QoE Profile and a Resource-Priority header was present in the SIP BYE request received from the PoC Client and if authorization of the Resource-Priority header was successful in step 1 a);
- 6. SHALL include a Privacy header, according to rules and procedures of [RFC3325], with the value set to the received SIP request Privacy header value, if the Privacy header is included in the received SIP request; and,
- 7. SHALL send the SIP BYE request towards the PoC Server performing the Controlling PoC Function according to rules and procedures of the SIP/IP Core.

Upon receiving a SIP 200 "OK" response to the SIP BYE request the PoC Server SHALL interact with the User Plane as specified in [OMA-PoC-UP] "*Participating PoC Function procedures at PoC Session release*" for releasing User Plane resources associated with the SIP Session with the PoC Server performing the Controlling PoC Function.

When acting as a SIP proxy the rules and procedures as specified in [RFC3261] SHALL be applied

NOTE: Per [RFC 4412] a PoC Server acting as a SIP proxy can reject a SIP request with an unauthorized Resource-Priority header.

When the SIP/IP Core corresponds with 3GPP/3GPP2 IMS, the PoC Server SHALL use 3GPP/3GPP2 IMS mechanisms according to rules and procedures of [3GPP TS 24.229] / [3GPP2 X.S0013.4] with the clarifications given in this subclause.

7.3.1.10.2 SIP REFER BYE request from PoC Client – Pre-established Session case

Upon receiving from the PoC Client a SIP REFER request with the method parameter set to value "BYE" in the Refer-To header the PoC Server:

- 1. in case of a PoC Session is established within a Pre-established Session as specified in subclause 6.1.3.2.2 "*PoC Client initiates an Ad-hoc PoC Group Session and 1-1 PoC Session*", the PoC Server
 - a) SHALL perform the procedures as specified in subclause 7.2.1.9.2 "*SIP REFER BYE request received within a Pre-established Session*". Do not continue the rest of the steps.
- 2. in case of a PoC Session is established within Pre-established Session, as specified in subclause 6.1.3.2.3 "*PoC Client initiates a Pre-arranged PoC Group Session or joins a Chat PoC Group Session*", or by sending a TBCP message to the PoC Client as specified in [OMA-PoC-UP] "*Participating PoC Function procedures at PoC Session initialization*", the PoC Server
 - a) SHOULD check if a Resource-Priority header is included in the SIP REFER request according to rules and procedures of [RFC4412], if the 'Official Government Use' QoE Profile is supported. If included the PoC Server SHALL:
 - i. perform actions to authorize the Resource-Priority header, as specified in subclause 5.8 "*QoE Profiles*". If the Resource-Priority header cannot be authorized, the PoC Server SHALL skip step ii and proceed with the rest of the steps; and,
 - ii. apply preferential treatment to the SIP request, as specified in [RFC4412], and proceed with the rest of the steps;
 - b) SHALL extract from the Refer-To header the PoC Session Identity that the PoC Client wants to leave;
 - c) SHALL generate a final SIP 2xx response to the SIP REFER request according to rules and procedures of [RFC3515];
 - d) SHALL include in the response to the SIP REFER request a Supported header with the option tag 'norefersub' according to rules and procedures of [RFC4488], if the SIP REFER request was an initial SIP request received outside of an existing dialog;
 - e) SHALL check the presence of the Refer-Sub header of the SIP REFER request and if it is present and it has the value 'false' then the PoC Server SHALL include in the response to the SIP REFER request a Refer-Sub header set to 'false' according to rules and procedures of [RFC4488];
 - f) SHALL send the SIP response to the SIP REFER request towards the PoC Client according to rules and procedures of the SIP/IP Core;
 - g) SHALL generate a SIP BYE request and set the Request-URI to the PoC Session Identity;
 - h) SHALL include a Resource-Priority header, according to the rules and procedures of [RFC4412] set to the same value as the one received in the SIP BYE request, if the PoC Server supports 'Official Government Use' QoE Profile and a Resource-Priority header was present in the SIP REFER request received from the PoC Client and if authorization of the Resource-Priority header was successful in step 2 a) i);
 - i) SHALL include a Privacy header, according to rules and procedures of [RFC3325], with the value set to the received SIP request Privacy header value, if the Privacy header is included in the received SIP request;
 - j) SHALL send the SIP BYE request towards the Controlling PoC Function according to rules and procedures of the SIP/IP Core;
 - k) SHALL upon receiving a SIP 200 "OK" response for the SIP BYE request interact with the User Plane as specified in [OMA-PoC-UP] "*Participating PoC Function procedures at PoC Session release*" for releasing User Plane resources towards the Controlling PoC Function; and,
 - l) SHALL generate and send the PoC Client a SIP NOTIFY request(s) as specified in the subclause 7.2.1.17 "*Generating a SIP NOTIFY request to the SIP REFER request*" based on the progress of the BYE request, if the Refer-Sub header is not present or it is set to 'true' in the SIP REFER request.

NOTE: A SIP REFER request according to rules and procedures of [RFC3515] or [draft-multiple-refer] is an implicit subscription to event "refer" in case the Refer-Sub header is not present or is set to 'true'.

When the SIP/IP Core corresponds with 3GPP/3GPP2 IMS, the PoC Client SHALL use 3GPP/3GPP2 IMS mechanisms according to rules and procedures of [3GPP TS 24.229] / [3GPP2 X.S0013.4] with the clarifications given in this subclause.

7.3.1.10.3 Pre-established Session release request from PoC Client

Upon receiving a SIP BYE request from the PoC Client within a Pre-established Session the PoC Server:

- 1. SHOULD check whether there is a PoC Session using the Pre-established Session. If there is not, then the PoC Server
 - a) SHALL check if a Resource-Priority header is included in the SIP BYE request according to the rules and procedures of [RFC4412], if the 'Official Government Use' QoE Profile is supported. If included the PoC Server SHALL:
 - i. perform actions to authorize the Resource-Priority header, as specified in subclause 5.8 "QoE Profiles". If the Resource-Priority header cannot be authorized, the PoC Server SHALL skip step ii and proceed with the rest of the steps; and,
 - ii. apply preferential treatment to the SIP request, as specified in [RFC4412], and proceed with the rest of the steps;
 - b) SHALL interact with the User Plane as specified in [OMA-PoC-UP] "*Participating PoC Function procedures at PoC Session release*" for disconnecting the User Plane resources towards the PoC Client; and,
 - c) SHALL generate and send a SIP 200 "OK" response to the SIP BYE request according to rules and procedures of the SIP/IP Core.
- 2. SHALL check whether there is a PoC Session using the Pre-established Session and the PoC Session is controlled by this PoC Server. If there is then the PoC Server
 - a) SHALL remove the owner from the PoC Session by performing the procedures as specified in subclause 7.2.1.9.3 "*SIP BYE request received within a Pre-established Session*"; and,
 - b) SHALL generate and send a SIP 200 "OK" response to the SIP BYE request according to rules and procedures of the SIP/IP Core;
- 3. SHALL check whether there is a PoC Session establishment on-going using the Pre-established Session and the PoC Session is controlled by this PoC Server. If there is, the PoC Server:
 - a) SHALL cancel the request performing the procedures as specified in subclause 7.2.1.10 "*Cancel of PoC Session setup request*";
 - b) SHALL generate and send a SIP 200 "OK" response to the SIP BYE request according to rules and procedures of the SIP/IP Core; and,
 - c) SHALL release the PoC Session as specified in the subclause 7.2.2.4 "*Removal of Participant from PoC Session*", if a SIP 2xx response for the SIP INVITE request is received from an Invited PoC Client;
- 4. SHALL check whether there is a PoC Session establishment on-going using the Pre-established Session and the PoC Session is controlled by another PoC Server. If there is, the PoC Server:
 - a) SHALL cancel the request performing the procedures as specified in subclause 7.3.1.9 "*SIP CANCEL request*";
 - b) SHALL generate and send a SIP 200 "OK" response to the SIP BYE request according to rules and procedures of the SIP/IP Core; and,
 - c) SHALL release the PoC Session as specified in the subclause 7.3.1.10.1 "*SIP BYE request from PoC Client – On-demand Session case*", if a SIP 2xx response for the SIP INVITE request is received from PoC Server performing the Controlling PoC Function;
- 5. SHALL check whether there is a PoC Session using the Pre-established Session, but is not controlled by this PoC Server. If there is, then the PoC Server
 - a) SHALL generate a SIP BYE request and set the Request-URI to the PoC Session Identity;
 - b) SHALL include a Resource-Priority header, according to the rules and procedures of [RFC4412] set to the same value if the PoC Server supports 'Official Government Use' QoE Profile and a Resource-Priority header was present in the SIP BYE request received from the PoC Client and if authorization of the Resource-Priority header was successful in step 1 a) i;
 - c) SHALL include a Privacy header, according to rules and procedures of [RFC3325], with the value set to the received SIP request Privacy header value, if the Privacy header is included in the received SIP request; and,
 - d) SHALL send the SIP BYE request towards the Controlling PoC Function according to the procedures of the SIP/IP Core.

Upon receiving a SIP 200 "OK" response from the Controlling PoC Function as a response to the SIP BYE request, the PoC Server:

- 1. SHALL interact with the User Plane as specified in [OMA-PoC-UP] "*Participating PoC Function procedures at PoC Session release*" for releasing User Plane resources towards the Controlling PoC Function;
- 2. SHALL interact with the User Plane as specified in [OMA-PoC-UP] "*Participating PoC Function procedures at PoC Session release*" for releasing User Plane resources towards the PoC Client; and,
- 3. SHALL send a SIP 200 "OK" response to the PoC Client.

When the SIP/IP Core corresponds with 3GPP/3GPP2 IMS, the PoC Server SHALL use 3GPP/3GPP2 IMS mechanisms according to rules and procedures of [3GPP TS 24.229] / [3GPP2 X.S0013.4] with the clarifications given in this subclause.

7.3.1.11 Group Advertisement request

Upon receiving a SIP MESSAGE request containing the PoC feature tag '+g.poc.groupad' in the Accept-Contact header field the PoC Server:

- 1. SHALL reject the SIP MESSAGE request with a SIP 403 "Forbidden" response with the warning text set to '121 Function not allowed due to <detailed reason>' as specified in subclause 5.6 "*Warning header*", if Group Advertisement is not supported by the PoC Server. Otherwise, continue with the rest of the steps
- 2. SHALL return a SIP 403 "Forbidden" response with the warning text set to '119 Anonymity not allowed' as specified in subclause 5.6 "*Warning header*", if anonymity is requested. Otherwise, continue with the rest of the steps;
- 3. SHALL perform actions to verify the Authenticated Originator's PoC Address of the PoC User and authorize the request according to local policy, and if not authorized the PoC Server SHALL return a SIP 403 "Forbidden" response with the warning text set to '121 Function not allowed due to <detailed reason>' as specified in subclause 5.6 "*Warning header*". Otherwise, continue with the rest of the steps;
- 4. SHALL continue as specified in subclause 7.2.1.12 "*Group Advertisement request*", if the Request-URI contains a SIP URI corresponding to the Exploder URI known by the PoC Server. Otherwise, continue with the following step;
- 5. SHALL check the total size of text content in the Subject header, if Included Text Content is supported by the PoC Server and if Subject header is included, and if the total size exceeds a configurable max size remove the text content;
- 6. SHALL perform the following actions, if Included Media Content is supported by the PoC Server and if media content is included in one or more MIME bodies:
 - a) authorize the Media Type of the media content in all MIME bodies using a Service Provider configurable setting and if at least one Media Type was not allowed, based on a Service Provider Policy either,
 - i. send a SIP 415 "Unsupported Media Type", the SIP 415 "Unsupported Media Type" response SHALL include:
 - 1) the Accept header with the acceptable Media Types that the PoC Server would accept according to rules and procedures of [RFC3261]; or,
 - 2) the Accept-Encoding header with the encoding formats that the PoC Server would accept according to rules and procedures of [RFC3261]; or,
 - 3) both
 and do not continue with the rest of the steps; or,
 - ii. remove the MIME bodies containing the media content that is not allowed.
 - b) Check the total size of all MIME bodies containing media content and if the total size exceeds a configurable max size, based on a Service Provider Policy either,
 - i. send a SIP 413 "Request Entity Too Large" response and do not continue with the rest of the steps; or,
 - ii. remove all MIME bodies containing media content.
- 7. MAY remove the Subject header;
- 8. MAY remove the Call-Info header; and,

NOTE: The reason for removing the Subject header and the reason for removing the Call-Info header may be a local policy in the PoC Server.

- 9. SHALL forward the SIP MESSAGE request to the SIP/IP Core.

Upon receiving SIP 415 "Unsupported Media Type" response for the SIP MESSAGE request and if the only accepted MIME type is "vnd.poc.group-advertisement+xml", the PoC Server SHOULD re-perform actions described in this subclause only including the MIME bodies indicated in the SIP 415 "Unsupported Media Type" response.

Upon receiving other SIP final response the PoC Server SHALL forward the SIP final response according to rules and procedures of [RFC3261].

When the SIP/IP Core corresponds with 3GPP/3GPP2 IMS, the PoC Client SHALL use 3GPP/3GPP2 IMS mechanisms according to rules and procedures of [3GPP TS 24.229] / [3GPP2 X.S0013.4] with the clarifications given in this subclause.

7.3.1.12 Simultaneous PoC Session control procedures

7.3.1.12.1 General

NOTE: This subclause provides common procedures for other subclauses and is not meant to be applied unless referenced.

The support of Simultaneous PoC Sessions is optional for the PoC Server. The following procedures in this subclause are only applicable when the PoC Server supports Simultaneous PoC Sessions. In the following subclauses only Simultaneous PoC Sessions specific details are described, all other details are specified in subclauses 7.3.1.2 "Pre-established Session", 7.3.1.3 "Pre-established Session modifications", 7.3.1.4 "PoC Session establishment or rejoin using On-demand Session" and 7.3.1.6 "PoC Session modifications".

7.3.1.12.2 PoC Session priority request

Upon receiving a SIP INVITE or SIP UPDATE or SIP re-INVITE request containing the PoC Session priority parameter as specified in E.3.1 "Media Burst Control Protocol MIME registration" in the SDP offer the PoC Server:

- 1. SHALL validate that the PoC Session priority in the SDP offer is acceptable to PoC Server and if not reject the request with a SIP 488 "Not Acceptable Here" response. Otherwise, continue with the rest of the steps;
- 2. SHALL check the PoC Session priority parameter, if included in the SDP offer;
 - a) if the PoC Session priority parameter "poc_sess_priority" is 0 or no "poc_sess_priority" is included and the local policy allows then the PoC Server SHALL set the PoC Session priority to secondary, perform procedures specified in [OMA-PoC-UP] "Simultaneous PoC Session state diagram – per User"; or,
 - b) if the PoC Session priority value "poc_sess_priority" is 1 and the local policy allows then the PoC Server SHALL set the PoC Session priority to primary and ensure that all other PoC Sessions have the secondary priority, and perform procedures specified in [OMA-PoC-UP] "Simultaneous PoC Session state diagram – per User".
- 3. SHALL remove the PoC Session priority parameter in the SDP payload when the request is forwarded to Controlling PoC Function and the PoC Server support PoC Session priority;
- 4. SHALL generate a SIP 200 "OK" response containing an SDP answer that indicates the selected priority parameter according to rules and procedures of [RFC2337] and [RFC3264]; and,
- 5. SHALL send the SIP 200 "OK" response to the SIP/IP Core along the signalling path.

NOTE 1: The PoC Server performing Participating PoC Function if not recognizing a parameter will ignore it and pass it towards PoC Server performing the Controlling PoC Function. The PoC Server SHALL set the PoC Session priority by default to secondary if the PoC Client does not indicate the priority in the request.

NOTE 2: Only one PoC Session can be set a Primary PoC Session at the given time.

When the SIP/IP Core corresponds with 3GPP/3GPP2 IMS, the PoC Server SHALL use 3GPP/3GPP2 IMS mechanisms according to rules and procedures of [3GPP TS 24.229] / [3GPP2 X.S0013.4] with the clarifications given in this subclause.

7.3.1.12.3 PoC Session locking request

Upon receiving a SIP INVITE or SIP UPDATE or SIP re-INVITE request containing the PoC Session locking parameter in the SDP offer as specified in E.3.1 "Media Burst Control Protocol MIME registration", the PoC Server:

- 1. SHALL validate that the PoC Session locking in the SDP offer are acceptable to the PoC Server and if not reject the request with a SIP 488 "Not Acceptable Here" response. Otherwise, continue with the rest of the steps;
- 2. SHALL check the PoC Session locking parameter "poc_lock" if included in the SDP offer;
 - a) if the PoC Session locking parameter "poc_lock" is 1 then the PoC Server SHALL set the PoC Session locked and perform procedures as specified in [OMA-PoC-UP] "*Simultaneous PoC Session state diagram – per User*"; or,
 - b) if the PoC Session locking parameter "poc_lock" is 0 or no "poc_lock" parameter is included then the PoC Server SHALL set the PoC Session unlocked and perform procedures as specified in [OMA-PoC-UP] "*Simultaneous PoC Session state diagram – per User*";
- 3. SHALL remove the PoC Session locking parameter "poc_lock" in the SDP payload when the request is forwarded to the PoC Server performing the Controlling PoC Function and the PoC Server supports PoC Session locking.
- 4. SHALL generate a SIP 200 "OK" response containing the SDP answer that indicates the selected locking parameter according to rules and procedures of [RFC2337] and [RFC3264]; and,
- 5. SHALL send the SIP 200 "OK" response to the SIP/IP Core along the signaling path.

NOTE 1: The PoC Server performing the Participating PoC Function if not recognizing a parameter will ignore it and pass it towards the PoC Server performing the Controlling PoC Function.

NOTE 2: Only one PoC Session can be set locked at the given time.

When the SIP/IP Core corresponds with 3GPP/3GPP2 IMS, the PoC Server SHALL use 3GPP/3GPP2 IMS mechanisms according to rules and procedures of [3GPP TS 24.229] / [3GPP2 X.S0013.4] with the clarifications given in this subclause.

7.3.1.13 SIP Session timer expiry

On expiry of the SIP Session timer and if the PoC Server acts as a B2BUA the PoC Server:

- 1. SHALL interact with the User Plane as specified in [OMA-PoC-UP] "*Participating PoC Function procedures at PoC Session release*";
- 2. SHALL generate a SIP REFER request according to rules and procedures of [RFC3515];
- 3. SHALL set the Request-URI of the SIP REFER request to the PoC Session Identity of an ongoing PoC Session;
- 4. SHALL set the Refer-To header of the SIP REFER request to the PoC Address of the PoC User at the PoC Client, whose SIP Session timer has expired;
- 5. SHALL include the "method" parameter with the value "BYE" in the Refer-To header;
- 6. SHALL include the following according to rules and procedures of [RFC4488]:
 - a) the option tag 'norefersub' in the Require header; and,
 - b) the value 'false' in the Refer-Sub header.
- 7. SHOULD include a Resource-Priority header according to rules and procedures of [RFC4412], if the SIP Session timer expired PoC Client is allowed to use the 'Official Government Use' QoE Profile and the 'Official Government Use' QoE Profile was used at the PoC Session initiation. If included, the value of the Resource-Priority header SHALL be equal to the level of priority used at the PoC Session initiation, as specified in subclause 5.8 "*QoE Profiles*"; the Resource-Priority header is included as a header of the REFER request as well as a Refer-to URI parameter; and,
- 8. SHALL send the SIP REFER request towards the PoC Server within the existing dialog according to rules and procedures of the SIP/IP Core.

Upon receiving a SIP 2xx response to the SIP REFER request with the method parameter set to value "BYE" in the Refer-To header from the PoC Server performing Controlling PoC Function the PoC Server SHALL interact with the User Plane as specified in [OMA-PoC-UP] "*Participating PoC Function procedures at PoC Session release*" for releasing User Plane resources towards the PoC Server performing the Controlling PoC Function.

When the SIP/IP Core corresponds with 3GPP/3GPP2 IMS, the PoC Server SHALL use 3GPP/3GPP2 IMS Session mechanisms according to rules and procedures of [3GPP TS 24.229] / [3GPP2 X.S0013.4] with the clarifications given in this subclause.

7.3.1.14 PoC Service Setting procedure

Upon receiving a SIP PUBLISH request the PoC Server:

- 1. SHALL check whether the Event header includes value 'poc-settings' and if not included the PoC Server SHALL return a SIP 489 "Bad event" response. Otherwise, continue with the rest of the steps;
- 2. SHALL perform actions to verify the Authenticated Originator's PoC Address of the PoC Client and authorize the request according to local policy, and if not authorized the PoC Server SHALL return a SIP 403 "Forbidden" response with the warning text set to '121 Function not allowed due to <detailed reason>' as specified in subclause 5.6 "Warning header". Otherwise, continue with the rest of the steps;
- 3. SHALL check if the Authenticated Originator's Address is registered by the PoC Client as specified in the subclause 5.7A "PoC Session association" and if that is the case continue with the rest of the steps;
- 4. SHOULD check if a Resource-Priority header is included in the SIP PUBLISH request according to the rules and procedures of [RFC4412], if the 'Official Government Use' QoE Profile is supported. If included the PoC Server SHALL:
 - a) perform actions to authorize the Resource-Priority header, as specified in subclause 5.8 "QoE Profiles". If the Resource-Priority header cannot be authorized, the PoC Server SHALL reject the request with a SIP 403 "Forbidden" response with the warning text set to '115 <RequestedQoE> QoE Profile not authorized' as specified in subclause 5.6 "Warning header"; and,
 - b) apply preferential treatment to the SIP request, as specified in [RFC4412], and proceed with the rest of the steps.
- 5. SHALL process the SIP PUBLISH request according to rules and procedures of [RFC3903] and if processing of the SIP request was not successful, do not continue with the rest of the steps;
- 6. SHALL cache the received PoC Service Settings until PoC Service Settings expiration timer is expired as specified in subclause 5.7A "PoC Session association";

NOTE: The PoC Service Settings are listed in subclause 6.1.2 "PoC Service Settings procedure".

- 7. SHALL use the following default values for the following optional PoC Service Settings, if not included in the received SIP PUBLISH request.
 - a) The default value of Invited Parties Identity Information Mode is 'false';
 - b) The default value of Included Media Content in a Request Support is 'false';
 - c) The default value of Referenced Media Content in a Request Support is 'false';
 - d) The default value of Text Content in a Request Support is 'false';
 - e) The default value of PoC Box use setting is 'unwilling' and,
 - f) The default value of Privacy value as specified in [RFC3323] and [RFC3325] is 'none'.
- 8. SHALL generate a SIP 200 "OK" response according to rules and procedures of [RFC3261];
- 9. SHALL include a Server header to indicate the OMA PoC release version of the PoC Server as specified in subclause E.4.1 "Release version in User-agent and Server headers"; and,
- 10. SHALL send SIP 200 "OK" response to the SIP PUBLISH request.

When the SIP/IP Core corresponds with 3GPP/3GPP2 IMS, the PoC Server SHALL use 3GPP/3GPP2 IMS session mechanisms according to rules and procedures of [3GPP TS 24.229] / [3GPP2 X.PS0013.4] with the clarifications given in this subclause.

7.3.1.15 PoC Session release from User Plane

Upon receiving a PoC Session release request from the User Plane as specified in [OMA-PoC-UP] "Receive MBCP Media Burst Acknowledgement message (R: MB_Ack)" or "T15 (Connect message re-transmit) timer fired N times" or "Receive PoC Session release indication from PoC Client (R: PoC Session release from PoC Client)", the PoC Server:

- 1. SHALL remove the Participant referred by User Plane from the PoC Session by performing the procedures as specified in subclause 7.3.2.6.3 "Leaving a PoC Session when using Pre-established Session";
- 2. SHALL check the PoC Session release policy as specified in subclause 7.2.1.16 "PoC Session release policy" and according to the applied release policy perform for each Participant of the PoC Session (except for the owner of the

Pre-established Session) the procedures specified in subclause 7.2.2.4 "Removal of Participant from the PoC Session", if needed;

- 3. SHALL generate a notification of the current state of the PoC Session to the PoC Client(s), which have subscribed to the conference state event package, as specified in subclause 7.2.1.11.2 "Generating a SIP NOTIFY request";
- 4. SHALL check the subscription termination policy as specified in subclause 7.2.1.11.3 "Termination of subscription" and for each PoC Clients (except the owner of the Pre-established Session) terminate the existing subscription to the conference state event package, if needed; and,
- 5. SHALL send the SIP NOTIFY request to the PoC Client(s) according to rules and procedures of the SIP/IP Core.

When the SIP/IP Core corresponds with 3GPP/3GPP2 IMS, the PoC Server SHALL use 3GPP/3GPP2 IMS mechanisms according to rules and procedures of [3GPP TS 24.229] / [3GPP2 X.S0013.4] with the clarifications given in this subclause.

7.3.1.16 Discrete Media request

Upon receiving a SIP MESSAGE request not containing a MIME body of the MIME Type application/vnd.poc.fdcfo+xml either

- 1. outside the SIP dialog used for a PoC Session containing the PoC feature tag '+g.poc.discretemedia' in the Accept-Contact header field ; or,
- 2. inside the SIP dialog used for the PoC Session,

and the PoC Session Identity in the Request-URI not owned by this PoC Server, the PoC Server acting as B2BUA:

- 1. SHALL generate the SIP MESSAGE request as specified in [OMA_IM_TS_Endorsement] "Receiving SIP MESSAGE request for Pager mode";
- 2. SHALL include in the Accept-Contact header the PoC feature tag '+g.poc.discretemedia' according to rules and procedures of [RFC3841], if to be sent outside the SIP dialog used for the PoC Session;and
- 3. SHALL send the SIP MESSAGE request to the SIP/IP Core as specified in [OMA_IM_TS_Endorsement] "Receiving SIP MESSAGE request for Pager mode".

Upon receiving a SIP MESSAGE request containing the PoC feature tag '+g.poc.discretemedia' in the Accept-Contact header field and the PoC Session Identity in the Request-URI not owned by this PoC Server, the PoC Server acting as proxy:

- 1. SHALL check the SIP MESSAGE request as specified in [OMA_IM_TS_Endorsement] "Receiving SIP MESSAGE request for Pager mode";
- 2. SHALL forward the SIP MESSAGE request according to rules and procedures of [RFC3261].

NOTE: Responses for the SIP MESSAGE requests are described in [OMA_IM_TS_Endorsement] "Receiving SIP MESSAGE request for Pager mode".

When the SIP/IP Core corresponds with 3GPP/3GPP2 IMS, the PoC Server SHALL use 3GPP/3GPP2 IMS mechanisms according to rules and procedures of [3GPP TS 24.229] / [3GPP2 X.S0013.4] with the clarifications given in this subclause.

7.3.1.17 FDCFO Proceed request

Upon receiving a SIP MESSAGE request inside the SIP dialog used for the PoC Session with a MIME body of the MIME Type application/vnd.poc.fdcfo+xml and an identity in the Request-URI not owned by this PoC Server, the PoC Server:

- 1. SHALL generate the SIP MESSAGE request according to rules and procedures of [RFC3428];
-
- 2. SHALL include the PoC Address of the Inviting PoC User in the Authenticated Originator's PoC Address as specified in subclause 5.2 "Authenticated Originator's PoC Address";
- 3. SHALL include the User-Agent header to indicate the OMA PoC release version of the PoC Server as specified in subclause E.4.1 "Release version in User-agent and Server headers";
- 4. SHALL include the Privacy header with the value "id" if privacy is requested;
- 5. SHALL include the MIME application/vnd.poc.fdcfo+xml body received in the incoming SIP MESSAGE request; and,

- 6. SHALL send the SIP MESSAGE request to the SIP/IP Core inside the SIP dialog used for the PoC Session according to rules and procedures of SIP/ IP Core.

Upon receiving a SIP final response other than SIP 2xx final response the PoC Server SHALL forward the SIP final response along the signalling path towards the originating PoC Client according to rules and procedures of [RFC3261].

Upon receiving a SIP 2xx final response the PoC Server:

- 1. SHALL generate a SIP final response of the same status code as the received SIP response according to rules and procedures of [RFC3428];
- 2. SHALL include the Server header to indicate the OMA PoC release version of the PoC Server as specified in subclause E.4.1 "*Release version in User-agent and Server headers*"; and,
- 3. SHALL forward the SIP final response along the signalling path towards the originating PoC Client according to rules and procedures of [RFC3261].

When the SIP/IP Core corresponds with 3GPP/3GPP2 IMS, the PoC Server SHALL use 3GPP/3GPP2 IMS mechanisms according to rules and procedures of [TS24.229] / [3GPP2 X.S0013.4] with the clarifications given in this subclause.

7.3.1.18 Querying for capabilities

Upon receiving a SIP OPTIONS request containing a Request-URI with a Conference-Factory-URI owned by this PoC Server, the PoC Server:

- 1. SHALL handle the SIP OPTIONS request as an SIP INVITE request as specified in the subclause 7.3.1.4 "*PoC Session establishment or rejoin using On-demand Session*" modified as follows:
 - a) any procedure checking the offered Media Types, offered the Media-floor Control Entities or the offered Media-floor Control Entity bindings are executed as if a MIME SDP body containing MBTCP with bound PoC Speech was received;
 - b) the interactions with the User Plane are not performed;
 - c) the SIP OPTIONS request does not establish a PoC Session; and,
 - d) the subclause 7.2.1.26 "*Querying for capabilities*" is invoked instead of the subclause 7.2.1.2 "*Ad-hoc PoC Group and 1-1 PoC Session setup request*".

Upon receiving a SIP OPTIONS request containing a Request-URI not owned by this PoC Server, the PoC Server:

- 1. SHALL handle the SIP OPTIONS request as an SIP INVITE request as specified in the subclause 7.3.1.4 "*PoC Session establishment or rejoin using On-demand Session*" modified as follows:
 - a) any procedure checking the offered Media Types, offered the Media-floor Control Entities or the offered Media-floor Control Entity bindings are executed as if a MIME SDP body containing MBTCP with bound PoC Speech was received;
 - b) the interactions with the User Plane are not performed;
 - c) the SIP OPTIONS request is sent instead of the SIP INVITE request;
 - d) the SIP OPTIONS request does not establish a PoC Session; and,
 - e) if the SIP 200 "OK" response is generated and if the PoC Server acts as B2BUA, the PoC Server additionally:
 - i. SHOULD include in the SIP response an Allow header with the supported SIP methods according to rules and procedures of [RFC3261];
 - ii. SHOULD include in the SIP response an Accept header with the supported MIME body Media Types according to rules and procedures of [RFC3261];
 - iii. SHOULD include in the SIP response an Accept-Encoding header with the supported encoding formats according to rules and procedures of [RFC3261];
 - iv. SHOULD copy into the SIP response the Accept-Language header from the received 200 "OK" SIP response according to rules and procedures of [RFC3261];
 - v. SHOULD copy into the SIP response the Supported header from the received 200 "OK" SIP response according to rules and procedures of [RFC3261];
 - vi. SHALL either

1. remove the Contact header from the SIP response; or,
2. replace the Contact header value in the SIP response with the Contact header value and feature tags of the received SIP response according to rules and procedures of [RFC3261]; or,
3. replace a Contact header according to rules and procedures of [RFC3261] based on the Contact header of the incoming SIP response and the local policy of the PoC Server.

vii. SHALL either

1. remove the MIME SDP body from the SIP response; or,
2. replace the MIME SDP body in the SIP response with the MIME SDP body of the received SIP response to rules and procedures of [RFC3261]; or,
3. replace the MIME SDP body according to rules and procedures of [RFC3261] based on the content of the MIME SDP body of the received SIP response and the PoC Server's local policy.

NOTE: The MIME SDP body included in the SIP 200 "OK" response to the SIP OPTIONS request is not an SDP answer.

When the SIP/IP Core corresponds with 3GPP/3GPP2 IMS, the PoC Server SHALL use 3GPP/3GPP2 IMS Session establishment mechanisms according to rules and procedures of [3GPP TS 24.229] / [3GPP2 X.S0013.4] with the clarifications given in this subclause.

7.3.2 Requests terminated by the served PoC User

7.3.2a Backward compatibility

When PoC Server performing Participating PoC Function in the terminating PoC Network sends a SIP request towards the terminating PoC Clients, the PoC Server SHALL perform the actions according to the [OMA-PoC-1-CP] "*Requests terminated by the served PoC User*", if the User-Agent header received from the terminating PoC Client, when setting the PoC Service Settings, indicates the support only to the PoC 1 specifications.

The PoC Server performing Participating PoC Function SHALL indicate in the Server header the OMA PoC release version supported by the Invited PoC Client, when sending SIP responses back to the PoC Server performing Controlling PoC Function.

When the SIP/IP Core corresponds with 3GPP/3GPP2 IMS, the PoC Server SHALL use 3GPP/3GPP2 IMS mechanisms according to rules and procedures of [3GPP TS 24.229] / [3GPP2 X.S0013.4] with the clarifications given in this subclause.

7.3.2.1 General

NOTE 1: This subclause provides common procedures for other subclauses and is not meant to be applied unless referenced.

The PoC Server SHALL generate an initial SIP INVITE request according to rules and procedures of [RFC3261] with the clarifications in this subclause.

The PoC Server

- 1. SHALL include value 'id' in a Privacy header according to rules and procedures of [RFC3325] if anonymity is requested with the Privacy header containing the tag 'id';
- 2. SHALL include an Accept-Contact header with
 - a) the PoC feature tag '+g.poc.talkburst' with 'require' and 'explicit' parameters according to rules and procedures of [RFC3841]; and,
 - b) any other feature tag with the parameters received in the Accept-Contact header of the incoming SIP INVITE request from the Controlling PoC Function.
- 3. SHALL include a User-Agent header to indicate the OMA PoC release version of the PoC Server as specified in subclause E.4.1 "*Release version in User-agent and Server headers*";

- 4. SHOULD include the Session-Expires header in the INVITE according to rules and procedures of [RFC4028], "Generating an Initial Session Refresh Request". The "refresher" parameter SHALL be omitted.
- 5. SHALL include the option tag 'timer' in the Supported header;
- 6. SHALL include the option tag 'norefersub' in a Supported header;
- 7. SHOULD include the Allow header with the SIP methods supported in this SIP dialog according to rules and procedures of [RFC3261];
- 8. SHALL include a Contact header as follows:
 - a) a SIP URI constructed such that the PoC Server can also resolve it back to the original SIP URI provided in the SIP INVITE request by the Controlling PoC Function;
 - b) include the PoC feature tag '+g.poc.talkburst';
 - c) include the feature tag 'isfocus';
 - d) include the PoC feature tag '+g.poc.discretedia', if included in the incoming SIP request;
 - e) include the Session Type uri-parameter provided in the SIP INVITE request by the Controlling PoC Function; and,
 - f) include any other uri-parameter provided in the Contact header of the incoming SIP INVITE request by the Controlling PoC Function.
- 9. SHALL include the Authenticated Originator's PoC Address, along with any possible uri-parameter, if received in the incoming SIP INVITE request in the outgoing SIP INVITE request;
- 10. SHALL include the Nick Name as specified in subclause 5.4 "Nick Name".

NOTE 2: The use of the option tag 'precondition', as specified in [RFC3312] and the option tag '100rel', as specified in [RFC3262] is not defined in the POC-1 reference point.

- 11. SHALL include the MIME message/sipfrag body from the received SIP request, if the MIME message/sipfrag body indicating the Inviting PoC Client compliant only to the OMA PoC version 1.0 specification was included in the received SIP INVITE request and the regional and national regulations require that the Inviting PoC User is informed about recording before being recorded and the SIP INVITE request is being sent to the NW PoC Box;
- 12. SHALL include a Reject-Contact header the feature tags 'sip.automata' and 'sip.actor' with the value of 'principal' and 'sip.description' with the value "poc recording device" along with 'require' and 'explicit', if the MIME message/sipfrag body indicating the Inviting PoC Client compliant only to the OMA PoC version 1.0 specification was included in the received SIP INVITE request and the regional and national regulations require that the Inviting PoC User is informed about recording before being recorded and the SIP INVITE request is being sent to the PoC Client;

NOTE 3: The inclusion of the Reject-Contact header ensures that the Invited PoC Client cannot pass the PoC Session invitation to the collocated UE PoC Box.

- 13. SHALL include MIME bodies containing media content in the outgoing SIP INVITE request, if Included Media Content is supported by the PoC Server and if one or more MIME body containing media content are included in the incoming SIP INVITE request and if at least one MIME body containing media content was not removed as specified in subclause 7.3.2.2 "PoC Session invitation request";
- 14. SHALL include the Subject header received in the incoming SIP INVITE request into the outgoing SIP INVITE request, if Text Content is supported by the PoC Server and if text content is included in Subject header;
- 15. SHALL include the Alert-Info header and the Call-Info header received in the incoming SIP INVITE request into the outgoing SIP INVITE request, if Referenced Media Content is support by the PoC Server and if a reference to media content is included in the Alert-Info header or in the Call-Info header or both; and,
- 16. SHALL include a Resource-Priority header according to rules and procedures of [RFC4412] that is identical to the one in the incoming SIP INVITE request, if the PoC Server supports 'Official Government Use' QoE Profile and if a Resource-Priority header is included in the received SIP INVITE.

When sending a SIP provisional responses other than the SIP 100 "Trying" response to the SIP INVITE request, the PoC Server:

- 1. SHALL generate the SIP provisional response according to rules and procedures of [RFC3261];

- 2. SHALL include a Server header with the OMA PoC release version of the PoC Server as specified in subclause E.4.1 "Release version in User-agent and Server headers".
- 3. SHOULD include the Allow header with the SIP methods supported in this SIP dialog according to rules and procedures of [RFC3261], if not previously sent in a provisional response for this dialog;
- 4. SHALL include a Contact header with a SIP URI identifying this PoC Server and the PoC feature tag '+g.poc.talkburst' if not previously sent in a provisional response for this dialog;
- 5. SHALL include into the Contact header the feature tag '+g.poc.discretedia', if included in the Contact header of the incoming received SIP response;
- 6. SHALL copy into the Contact header the feature tags '+g.poc.dispatcher', 'sip.automata', 'sip.actor', 'sip.description' with their corresponding value if any of these are included in the Contact header of incoming received SIP response;
- 7. SHALL include as the URI in the Authenticated Originator's PoC Address in the outgoing SIP provisional response either
 - a) the URI contained in the Authenticated Originator's PoC Address received in the incoming SIP provisional response in the case of an On-demand Session establishment; or
 - b) the URI stored from the Request-URI received in the incoming SIP INVITE request in the case of a Pre-established Session establishment.
- 8. SHALL include the Nick Name as specified in subclause 5.4 "Nick Name";
- 9. SHALL include value 'id' in the Privacy header according to rules and procedures of [RFC3325], if the privacy is requested by the Privacy header with the value 'id' in the incoming SIP provisional response in the case of an On-demand Session establishment, by the Privacy header with the value 'id' in the SIP INVITE request received during the Pre-established Session establishment for the PoC User in the case of a Pre-established Session, or by the Privacy PoC Service Settings with the value set to 'id' in the case of Automatic Answer Mode of On-demand Session;
- 10. SHALL include the value 'none' in the Privacy header according to rules and procedures of [RFC3325] if the Privacy PoC Service Settings is set to 'none' in the case of Automatic Answer Mode and an On-demand Session;

NOTE 4: If the Privacy PoC Service Settings is not set at all, the Privacy header is not included in the case of Automatic Answer Mode and an On-demand Session.

- 11. SHALL include the warning text set to '108 Media content in INVITE discarded' as specified in subclause 5.6 "Warning header", if at least one MIME body containing media content was removed as specified in subclause 7.3.2.2 "PoC Session invitation request" if not previously sent in a provisional response for this SIP dialog;
- 12. SHALL include the warning text set to '108 Media content in INVITE discarded' as specified in subclause 5.6 "Warning header", if the Subject header was removed as specified in subclause 7.3.2.2 "PoC Session invitation request" if not previously sent in a provisional response for this SIP dialog; and,
- 13. SHALL include the warning text set to '108 Media content in INVITE discarded' as specified in subclause 5.6 "Warning header", if the Alert-Info header or Call-Info header was removed as specified in subclause 7.3.2.2 "PoC Session invitation request" if not previously sent in a provisional response for this SIP dialog.

NOTE 5: A maximum of three Warning headers can be included, one for Included Media Content, one for Referenced Media Content and one for Text Content.

When sending a SIP 200 "OK" response to the SIP INVITE request the PoC Server

- 1. SHALL generate the SIP 200 "OK" response according to rules and procedures of [RFC3261] and [RFC3262];
- 2. SHALL include as the URI in the Authenticated Originator's PoC Address in the outgoing SIP 200 "OK" response either
 - a) the URI contained in the Authenticated Originator's PoC Address received in the incoming SIP 200 "OK" response in the case of an On-demand Session establishment; or
 - b) the URI stored from the Request-URI received in the incoming SIP INVITE request in the case of a Pre-established Session establishment.
- 3. SHALL include the Nick Name as specified in subclause 5.4 "Nick Name";

- 4. SHALL include value 'id' in the Privacy header according to rules and procedures of [RFC3325], if the privacy is requested either through a Privacy header with the value 'id' in the incoming SIP final response in the case of an On-demand Session establishment, or in the SIP INVITE request received during the Pre-established Session establishment for the PoC User in the case of a Pre-established Session;
- 5. SHALL include the option tag 'timer' in the Require header;
- 6. SHALL include the Session-Expires header in the SIP 200 "OK" before sending the response towards the PoC Server performing the Controlling PoC Function according to rules and procedures of [RFC4028], "UAS Behavior". The "refresher" parameter in the Session-Expires header SHALL be set to 'uas';
- 7. SHALL start the SIP Session timer according to rules and procedures of [RFC4028];
- 8. SHOULD include the Allow header with the SIP methods supported in this dialog according to rules and procedures of [RFC3261], if not previously sent in a provisional response for this dialog;
- 9. SHALL include the Server header with the OMA PoC release version of the PoC Server as specified in subclause E.4.1 "Release version in User-agent and Server headers" if not previously sent in a provisional response for this dialog;
- 10. SHALL include a Contact header with a SIP URI identifying this PoC Server and the PoC feature tag '+g.poc.talkburst';
- 11. SHALL include into the Contact header the feature tag '+g.poc.discretemedia', if included in the Contact header of the incoming received SIP response;
- 12. SHALL include the Contact header the feature tags '+g.poc.dispatcher', 'sip.automata', 'sip.actor', 'sip.description' with their corresponding value if any of these are included in the Contact header of the incoming received SIP response;
- 13. SHALL include the warning text set to '108 Media content in INVITE discarded' as specified in subclause 5.6 "Warning header", if at least one MIME body containing media content was removed as specified in subclause 7.3.2.2 "PoC Session invitation request";
- 14. SHALL include the warning text set to '108 Media content in INVITE discarded' as specified in subclause 5.6 "Warning header", if the Subject header was removed as specified in subclause 7.3.2.2 "PoC Session invitation request";
- 15. SHALL include the warning text set to '108 Media content in INVITE discarded' as specified in subclause 5.6 "Warning header", if the Alert-Info header or Call-Info header was removed as specified in subclause 7.3.2.2 "PoC Session invitation request";

NOTE 6: A maximum of three Warning headers can be included, one for Included Media Content, one for Referenced Media Content and one for Text Content.

- 16. SHALL insert the uri-parameter "b2bua" to the URI of the PoC Server in the Contact header of the SIP response to the initial SIP request as specified in E.5.3 "Back to back UA uri-parameter", if the PoC Server performing Participating PoC Function indicates according to local policy to the Controlling PoC Function, that it acts as a B2BUA and stays on the Media path, and,
- 17. SHALL include the Accept-Language header with value received
 - a) in the received SIP 200 "OK" response, if the On-demand Session is used to initiate the PoC Session and the Accept-Language is included in the received SIP 200 "OK" response; or
 - b) in the SIP INVITE request initiating the Pre-established Session, if the Pre-established Session is used to initiate the PoC Session and the Accept-Language was included in the SIP INVITE request initiating the Pre-established Session;

When the SIP/IP Core corresponds with 3GPP/3GPP2 IMS, the PoC Server SHALL use 3GPP/3GPP2 IMS Session mechanisms according to rules and procedures of [3GPP TS 24.229] / [3GPP2 X.S0013.4] with the clarifications given in this subclause.

7.3.2.1a SDP offer generation

The SDP offer is generated based on the received SDP offer. The PoC Server SHALL offer the same or a subset based on local policy of the Media Streams and the connected Media-floor Control Entities as included in the received SDP offer.

When composing an SDP offer according to rules and procedures of [RFC3264] and [RFC4566] the PoC Server:

- 1. SHALL set the IP address of the PoC Server for each offered Media Stream from the list contained in the received SDP offer and for each offered Media-floor Control Entity from the list contained in the received SDP offer;
- 2. SHALL include the media-level section for each offered Media Stream from the list contained in the received SDP offer consisting of:
 - a) the port number for the Media Stream selected as specified in [OMA-PoC-UP] "*Port numbers*";
 - b) the codec(s) and Media Parameters selected by the PoC Server from the list contained in the received SDP offer; and optionally the codec(s) and Media Parameters, which can be transcoded by the PoC Server to a codec contained in the received SDP offer, if transcoding is supported by the PoC Server;

NOTE 1: The Media Parameters of the Discrete Media are specified in [OMA_IM_TS_Endorsement].

- c) the "a=label" attribute with a unique value as specified in [RFC4574], if the Media Stream is to be connected to a Media-floor Control Entity except when only PoC Speech with Talk Burst Control Protocol as specified in [OMA-POC-1-UP] is offered;
- d) the "i=" field set to "speech" as specified in subclause 5.10 "*PoC Speech*" when PoC Speech with MBCP is offered;

NOTE 2: PoC Speech Media exists at most once in the SDP offer.

- e) the IP address of the PoC Server and port number to be used for RTCP at the PoC Server selected as specified in [OMA-PoC-UP] "*Port numbers*", according to rules and procedures of [RFC3605], if the Media stream uses the RTCP protocol and other than the default IP address or port number specified by the [RFC3550] is to be used; and,
 - f) include the "a=setup" attribute with the value "actpass" according to rules and procedures of [RFC4145] if the Media Type is "message" if the PoC Server is not sure if the PoC Client is behind NAT or not.
- 3. SHALL include the media-level section of each offered Media-floor Control Entity from the list contained in the received SDP offer, if any Media-floor Control Entity is offered:
 - a) the format list field for the Media-floor Control Entity set to "TBCP";
 - b) the Media-floor Control Entity parameters selected by the PoC Server from the received SDP offer;
 - c) the port number for Media-floor Control Entity selected as specified in [OMA-PoC-UP] "*Port numbers*";
 - d) the "a=floorid:0 mstrm" attribute with value(s) referencing the Media as specified in [RFC4583] intended to be connected to the Media-floor Control Entity except when only PoC Speech with Talk Burst Control Protocol as specified in [OMA-POC-1-UP] is offered; and,
 - e) optionally TBCP MIME parameters in the received SDP offer as specified in E.3 "SDP Extensions", TBCP MIME parameter "multimedia=1" is included, unless only PoC Speech with Talk Burst Control Protocol as specified in [OMA-POC-1-UP] is offered.
 - 4. SHALL mark as rejected according to rules and procedures of [RFC3264] the Media-floor Control Entity and all the Media Stream bound to the rejected Media-floor Control Entity, if the Media-floor Control Entity is rejected;
 - 5. SHALL mark the Media Stream as rejected according to rules and procedures of [RFC3264], if the Media Stream is rejected;
 - 6. SHALL include the received QoE Profile attribute as specified in subclause E.3.2 "*QoE Profile*", if QoE Profiles are enabled and if a QoE Profile attribute is present in the received SDP offer.

When composing an SDP offer, the PoC Server:

- 1. SHALL bind the media-level section that identifies PoC Speech to Media-floor Control Entity as in the received SDP offer, if PoC Speech is offered;
- 2. SHALL bind the media-level section that identifies Video to Media-floor Control Entity as in the received SDP offer, if Video is offered;
- 3. SHALL bind the media-level section that identifies Audio to Media-floor Control Entity as in the received SDP offer, if Audio is offered; and,
- 4. SHALL bind the media-level section that identifies Discrete Media to Media-floor Control Entity as in received SDP offer, if Discrete Media is offered and bound to the Media-floor Control Entity.

When the SIP/IP Core corresponds with 3GPP/3GPP2 IMS, the PoC Server SHALL use 3GPP/3GPP2 IMS mechanisms according to rules and procedures of [3GPP TS 24.229] / [3GPP2 X.S0013.4] with the clarifications given in this subclause.

7.3.2.1b SDP answer generation in case of On-demand session

When composing an SDP answer according to rules and procedures of [RFC3264] and [RFC4566] the PoC Server:

- 1. SHALL set the IP address of the PoC Server for each accepted Media Stream from the list contained in the received SDP offer and for each accepted Media-floor Control Entity from the list contained in the received SDP offer;
- 2. SHALL include the media-level section for each accepted Media Stream from the list contained in the received SDP offer consisting of:
 - a) the port number for the Media Stream selected as specified in [OMA-PoC-UP] "*Port numbers*";
 - b) the codec(s) and Media Parameters selected by the PoC Server from the list contained in the received SDP offer, optionally reduced based on the SDP answer received in SIP 200 "OK" response from the Invited PoC Client;

NOTE 1: The Media Parameters of the Discrete Media are defined in [OMA_IM_TS_Endorsement].

NOTE 2: If transcoding is supported and codec(s) and Media Parameters other than those contained in the received SDP offer have been offered in the SDP of the SIP INVITE request sent to Invited PoC Client(s), the SDP answer in the SIP 200 "OK" response towards Controlling PoC Function may be different from the SDP answer received in SIP 200 "OK" response from the Invited PoC Client(s);

- c) the "a=label" attribute with a unique value as specified in [RFC4574], if the Media Stream is to be connected to a Media-floor Control Entity except when only PoC Speech with Talk Burst Control Protocol as specified in [OMA-POC-1-UP] is accepted;
- d) the IP address of the PoC Server and port number to be used for RTCP selected as specified in [OMA-PoC-UP] "*Port numbers*", according to rules and procedures of [RFC3605], if the Media Stream uses the RTCP protocol and other than the default IP address or port number specified by the [RFC3550] is to be used;
- e) the "a=upcc:0" attribute as specified by [RFC3108], if the PoC Server supports the PoC Media Traffic Optimisation, the Participant did not put the PoC Session on hold and the media-level section offers a Continuous Media; and,
- f) the "a=sendonly" attribute according to rules and procedures of [RFC4566], if the PoC Server supports the PoC Media Traffic Optimisation, the Participant did not put the PoC Session on hold, the media-level section offers a Continuous Media, the "a=upcc:0" attribute is offered for the Media Stream in the received SDP offer and the RTP Session of the SIP Session of the other Participant is selected for the Media transmission between the PoC Server and the PoC Server performing the Controlling PoC Function.
- 3. SHALL include for any Media-floor Control Entity, that is offered in the SDP offer from the PoC Server and accepted in the SDP answer by PoC Client, the media-level section of each offered Media-floor Control Entity consisting of:
 - a) the format list field for the Media-floor Control Entity set to "TBCP";
 - b) the Media-floor Control Entity parameters selected by the PoC Server from those contained in the SDP answer from the Invited PoC Client;
 - c) the port number for Media-floor Control Entity selected as specified in [OMA-PoC-UP] "*Port numbers*";
 - d) the "a=floorid:0 mstrm" attribute with value(s) referencing the Media Stream as specified in [RFC4583] intended to be connected the Media-floor Control Entity except when only PoC Speech with Talk Burst Control Protocol as specified in [OMA-POC-1-UP] is accepted; and,
 - e) optionally TBCP MIME parameters in the received SDP answer as specified in E.3 "*SDP Extensions*" including if needed the TBCP MIME parameter "multimedia" with the appropriated value as specified in E.3 "*SDP Extensions*".
- 4. SHALL mark as rejected according to rules and procedures of [RFC3264] the Media-floor Control Entity and all the Media Streams bound to the rejected Media-floor Control Entity, if a Media-floor Control Entity is rejected;

- 5. SHALL mark the Media Stream as rejected according to rules and procedures of [RFC3264], if the Media Stream is rejected; and,
- 6. SHALL include the received QoE Profile attribute as specified in subclause E.3.2 "*QoE Profile*", if QoE Profiles are enabled and if a QoE Profile attribute is present in the received SDP answer.

When composing an SDP answer, the PoC Server:

- 1. SHALL bind the media-level section that identifies PoC Speech to the corresponding Media-floor Control Entity as in the received SDP offer, if PoC Speech is accepted;
- 2. SHALL bind the media-level section that identifies Video to the corresponding Media-floor Control Entity as in the received SDP offer, if Video is accepted;
- 3. SHALL bind the media-level section that identifies Audio to the corresponding Media-floor Control Entity as in the received SDP offer, if Audio is accepted; and,
- 4. SHALL bind the media-level section that identifies Discrete Media to the corresponding Media-floor Control Entity as in the received SDP offer, if Discrete Media is accepted and bound to the Media-floor Control Entity.

When the SIP/IP Core corresponds with 3GPP/3GPP2 IMS, the PoC Server SHALL use 3GPP/3GPP2 IMS mechanisms according to rules and procedures of [3GPP TS 24.229] / [3GPP2 X.S0013.4] with the clarifications given in this subclause.

7.3.2.1c SDP answer generation in case of Pre-established Session

When composing an SDP answer according to rules and procedures of [RFC3264] and [RFC4566] the PoC Server:

- 1. SHALL set the IP address of the PoC Server for each accepted Media Stream from the list contained in the received SDP offer, which was also negotiated in Pre-established Session establishment as specified subclause 7.3.1.2 "*Pre-established Session*";
- 2. SHALL set the IP address of the PoC Server for each accepted Media-floor Control Entity from the list contained in the received SDP offer, which was also negotiated in Pre-established Session establishment as specified subclause 7.3.1.2 "*Pre-established Session*";
- 3. SHALL include the media-level section for each accepted Media Stream from the list contained in the received SDP offer, which was also negotiated in Pre-established Session establishment as specified subclause 7.3.1.2 "*Pre-established Session*", consisting of:
 - a) the port number for the Media Stream selected as specified in [OMA-PoC-UP] "*Port numbers*";
 - b) the codec(s) and Media Parameters selected by the PoC Server from the list contained in the received SDP offer, reduced based on the Media Parameters negotiated in Pre-established Session establishment as specified subclause 7.3.1.2 "*Pre-established Session*"; optionally also including the codec(s) and Media Parameters, which can be transcoded by the PoC Server to a codec contained in Media Parameters negotiated in Pre-established Session establishment as specified subclause 7.3.1.2 "*Pre-established Session*";

NOTE 1: The Media Parameters of the Discrete Media are defined in [OMA_IM_TS_Endorsement].

- c) the "a=label" attribute with a unique value as specified in [RFC4574], if the Media Stream is to be connected to a Media-floor Control Entity except when only PoC Speech with Talk Burst Control Protocol as specified in [OMA-POC-1-UP] is accepted;
- d) the "i=" field set to "speech" as specified in subclause 5.10 "*PoC Speech*" when PoC Speech with MBCP is offered.

NOTE 2: PoC Speech Media exists at most once in the SDP offer.

- e) the IP address of the PoC Server and port number to be used for RTCP selected as specified in [OMA-PoC-UP] "*Port numbers*", according to rules and procedures of [RFC3605], if the Media Stream uses the RTCP protocol and other than the default IP address or port number specified by the [RFC3550] is to be used;
- f) the "a=upcc:0" attribute as specified in [RFC3108], if the PoC Server supports the PoC Media Traffic Optimisation, the Participant did not put the PoC Session on hold and the media-level section offers a Continuous Media; and,
- g) the "a=sendonly" attribute according to rules and procedures of [RFC4566], if the PoC Server supports the PoC Media Traffic Optimisation, the Participant did not put the PoC Session on hold, the media-level section

offers a Continuous Media, the "a=upcc:0" attribute is offered for the Media Stream in the received SDP offer and the RTP Session of the SIP Session of the other Participant is selected for the Media transmission between the PoC Server and the PoC Server performing the Controlling PoC Function.

- 4. SHALL include for any Media-floor Control Entity, that is offered in the SDP offer from the PoC Server and accepted in the SDP answer by PoC Client, the media-level section of each offered Media-floor Control Entity consisting of:
 - a) the format list field for the Media-floor Control Entity set to "TBCP";
 - b) the Media-floor Control Entity parameters contained in the received SDP offer, restricted to Media-floor Control Entity parameters negotiated during the Pre-established Session establishment as specified in the subclause 7.3.1.2 "Pre-established Session";
 - c) the port number for Media-floor Control Entity selected as specified in [OMA-PoC-UP] "Port numbers";
 - d) the "a=floorid:0 mstrm" attribute with value(s) referencing the Media Stream as specified in [RFC4583] intended to be connected the Media-floor Control Entity except when only PoC Speech with Talk Burst Control Protocol is accepted; and,
 - e) optionally TBCP MIME parameters in the received SDP answer as specified in E.3 "SDP Extensions", including if needed the TBCP MIME parameter "multimedia" with the appropriated value as specified in E.3 "SDP Extensions".
- 5. SHALL mark as rejected according to rules and procedures of [RFC3264] the Media-floor Control Entity and all the Media Stream bound to the rejected Media-floor Control Entity, if the Media-floor Control Entity is rejected;
- 6. SHALL mark the Media Stream as rejected according to rules and procedures of [RFC3264], if the Media Stream is rejected; and,
- 7. SHALL include a QoE Profile attribute, as specified in subclause E.3.2 "QoE Profile", with the same value as the QoE Profile assigned to the Pre-established Session, if QoE Profiles are enabled.

When composing an SDP answer, the PoC Server:

- 1. SHALL bind the media-level section that identifies PoC Speech to the corresponding Media-floor Control Entity as in the received SDP offer, if PoC Speech is accepted;
- 2. SHALL bind the media-level section that identifies Video to the corresponding Media-floor Control Entity as in the received SDP offer, if Video is accepted;
- 3. SHALL bind the media-level section that identifies Audio to the corresponding Media-floor Control Entity as in the received SDP offer, if Audio is accepted; and,
- 4. SHALL bind the media-level section that identifies Discrete Media to the corresponding Media-floor Control Entity as in the received SDP offer, if Discrete Media is accepted and bound to the Media-floor Control Entity.

When the SIP/IP Core corresponds with 3GPP/3GPP2 IMS, the PoC Server SHALL use 3GPP/3GPP2 IMS mechanisms according to rules and procedures of [3GPP TS 24.229] / [3GPP2 X.S0013.4] with the clarifications given in this subclause.

7.3.2.2 PoC Session invitation request

Upon receiving an initial SIP INVITE request that includes a PoC Address in the Request-URI the PoC Server:

- 1. MAY reject the SIP INVITE request with a SIP 503 "Service Unavailable" response depending on the value of the requested QoE Profile if QoE Profiles are enabled, the PoC Server is acting as a B2BUA and a risk of congestion exists as specified in [OMA-PoC-UP] "Procedures at the PoC Server performing the Participating PoC Function". The PoC Server MAY include a Retry-After header to the 503 "Service Unavailable" response as specified in [RFC3261];

NOTE 1: The PoC Client is allowed to re-attempt the PoC Session establishment after the time defined by the Retry-After header.

- 2. SHALL check the presence of the 'isfocus' feature parameter in the URI of the Contact header and if it is not present then the PoC Server SHALL reject the request with a SIP 403 "Forbidden" response with the warning text set to '106 Isfocus not assigned' as specified in subclause 5.6 "Warning header". Otherwise continuing the rest of the steps;

- 3. SHALL check if the URI Usage Type uri-parameter is included in the Request-URI and if it is included with a value different from "uriusage=user" the PoC Server performing the Controlling PoC Function SHALL return a SIP 403 "Forbidden" response according to the rules and procedures of [RFC3261] with the warning text set to '130 Conflicting URI: <URI>' as specified in subclause 5.6 "Warning header". Otherwise, continue with the rest of the steps;
- 4. SHALL check the Invited PoC User's PoC Service Settings associated to the PoC Address received in the Request-URI. If the PoC Service Settings have not been received from the PoC Client yet or if PoC Service Settings expiration timer has expired, the PoC Server SHALL respond with a SIP 480 "Temporarily Unavailable" response. Otherwise continue with the rest of the steps;
- 5. SHALL check if the Authenticated Originator's PoC Address and the URI of Referred-By header in the initial SIP INVITE request is not 'true' in the <allow-reject-invite> action associated to the Invited PoC User indicated by the Request-URI as described in [OMA-PoC-Documents-Mgmt]. If at least one of them is 'true' then the PoC Server SHALL respond with a SIP 403 "Forbidden" response with the warning text set to '121 Function not allowed due to <detailed reason>' as specified in subclause 5.6 "Warning header". Otherwise continue with the rest of the steps;
- 6. SHALL, in case privacy is requested, check if the value associated to the <allow-anonymity> element as described in [OMA-PoC-Documents-Mgmt] is not 'false'. If it is 'false', the PoC Server SHALL respond with a SIP 433 "Anonymity Disallowed" response as specified in [RFC5079]. Otherwise continue with the rest of the steps;
- 7. SHALL check the Invited PoC User's Incoming PoC Session Barring setting associated to the PoC Address received in the Request-URI. If the Incoming PoC Session Barring is activated the PoC Server SHALL respond with a SIP 480 "Temporarily Unavailable" response and do not continue the rest of the steps if PoC Box functionality is not supported by PoC Server or the PoC User does not have a valid subscription to the NW PoC Box service;
- 8. SHALL check the total size of text content in the Subject header, if Included Text Content is supported by the PoC Server and if Subject header is included, and if the total size exceeds a configurable max size remove the text content;
- 9. SHALL perform the following actions, if Included Media Content is supported by the PoC Server and if media content is included in one or more MIME body:
 - a) check the PoC Service Setting for Included Media Content in a Request Support and if set to 'false' or not set at all and if at least one Media Type is not allowed according to local policy, either
 - i. send a SIP 415 "Unsupported Media Type". The SIP 415 "Unsupported Media Type" response SHALL include:
 - 1) the Accept header with the acceptable Media-Types that the PoC Server would accept according to rules and procedures of [RFC3261]; or,
 - 2) the Accept-Encoding header with the encoding formats that the PoC Server would accept according to rules and procedures of [RFC3261]; or,
 - 3) both.
 - and do not continue with the rest of the steps; or,
 - ii. remove all MIME bodies containing not allowed Media Types and continue with the rest of the steps.
 - b) check the total size of all MIME bodies containing media content and if the total size exceeds a configurable max size, based on a Service Provider Policy either,
 - i. send a SIP 413 "Request Entity Too Large" response and do not continue with the rest of the steps; or,
 - ii. remove all MIME bodies containing media content and continue with the rest of the steps.
- 10. MAY remove the Subject header;
- 11. MAY remove the Alert-Info or the Call-Info header or both;

NOTE 2: The reason for removing the Alert-Info header or the Call-Info header or both may be a local policy in the PoC Server or Referenced Media Content in a Request Support with value 'false'.

- 12. SHALL perform actions to authorize a QoE Profile attribute included in the received SDP offer, as specified in subclause 5.8 "QoE Profiles", if QoE Profiles are enabled and a QoE Profile attribute is included and marked as mandatory in the received SDP offer, as specified in subclause E.3.2 "QoE Profile". If the requested QoE Profile cannot be authorized, the PoC Server SHALL respond with a SIP 403 "Forbidden" response with the warning text set to '115 <RequestedQoE> QoE Profile not authorized' as specified in subclause 5.6 "Warning header". Otherwise, continue with the rest of the steps;

NOTE 3: 'Official Government Use' QoE Profile is automatically authorized at the terminating PoC Server to the Invited PoC Client, if the PoC Server supports this QoE Profile.

- 13. SHALL determine whether to route the SIP INVITE request to a PoC Box as specified in subclause 7.3.2.2.5.1 "*Determination of routing to a PoC Box upon an incoming invitation*" if the PoC Server supports PoC Box functionality;
- 14. SHALL route the request to a NW PoC as specified in subclause 7.3.2.2.5.3 "*Forward invitations to a NW PoC Box*" if it was determined to route the invitation to a NW PoC Box and not continue with the rest of the steps;
- 15. SHALL route the request to a UE PoC as specified in subclause 7.3.2.2.5.4 "*Forward invitations to a UE PoC Box*" if it was determined to route the invitation to a UE PoC Box and not continue with the rest of the steps; and
- 16. SHALL, if the PoC Server supports 'Official Government Use' QoE Profile and acts as a B2BUA, check if the SIP INVITE request includes a Resource-Priority header according to rules and procedures of [RFC4412], and if so, check whether the PoC Client has an existing PoC Session, but does not support Simultaneous PoC Sessions. If true, and if the incoming PoC Session has a higher PoC Session Precedence than the currently existing PoC Session, and if in accordance with Service Provider Policy, the PoC Server SHALL release the PoC Session, as specified in subclause 7.3.2.10 "*PoC Server Releases a PoC Session*". Then skip to step 18;
- 17. SHALL, if the PoC Server supports 'Official Government Use' QoE Profile and acts as a B2BUA, check if the SIP INVITE request includes a Resource-Priority header according to rules and procedures of [RFC4412], and if so, check whether the PoC Client has an existing locked PoC Session and supports Simultaneous PoC Sessions. If true, and if the incoming PoC Session has a higher PoC Session Precedence than the locked PoC Session, then if in accordance with Service Provider Policy, the PoC Server SHALL release the locked PoC Session, as specified in subclause 7.3.2.10 "*PoC Server Releases a PoC Session*"; Then skip to step 18;
- 18. SHALL, if the PoC Server supports 'Official Government Use' QoE Profile and acts as a B2BUA, check if the SIP INVITE request includes a Resource-Priority header according to rules and procedures of [RFC4412], and if so, check whether the PoC Client supports Simultaneous PoC Sessions and has reached the maximum number of PoC Sessions permitted. If true, and if the incoming request has a higher PoC Session Precedence than the lowest currently established PoC Session, and if in accordance with Service Provider Policy, the PoC Server SHALL release the PoC Session of lowest PoC Session Precedence, as specified in subclause 7.3.2.10 "*PoC Server Releases a PoC Session*".
- 19. SHALL authorize whether the Authenticated Originator's PoC Address in the SIP INVITE request is allowed by the action <allow-manual-answer-override> as specified in [PoC-Documents-Mgmt], if a Priv-Answer-Mode header with the value 'Auto' is present in the incoming SIP INVITE request and if not authorized or if manual answer override is not supported the PoC Server SHALL return a SIP 403 "Forbidden" response with the warning text set to '121 Function not allowed due to <detailed reason>' as specified in subclause 5.6 "*Warning header*". Otherwise continue with the rest of the steps;
- 20. SHALL perform the actions specified in subclause 7.3.2.2a "*Automatic-answer*", if:
 - a) the received SIP INVITE request contained a Priv-Answer-Mode header with the value set to 'Auto', or
 - b) all the following applies:
 - i. the Authenticated Originator's PoC Address in the SIP INVITE request is 'true' by the <allow-auto-answer-mode> action associated to the Invited PoC User as described in [OMA-PoC-Documents-Mgmt];
 - ii. the result of the <allow-auto-answer-mode> action for each offered Media Stream is 'true' according to the <media> condition of the Invited PoC User's User Access Policy as described in [XDM_Shared_Policy];
 - iii. the Answer Mode Indication setting in the PoC Service Settings of the Invited PoC User is set to Automatic Answer;
 - iv. the received SIP INVITE request did not contain an Answer-Mode header with the value set to 'Manual;Require'; and,
 - v. the PoC Server does not have already a PoC Session with the PoC Client.

Otherwise, continue with the rest of the step; and,
- 21. SHALL perform the actions specified in subclause 7.3.2.2b "*Manual-answer*"

When the SIP/IP Core corresponds with 3GPP/3GPP2 IMS, the PoC Server SHALL use 3GPP/3GPP2 IMS Session establishment mechanisms according to rules and procedures of [TS24.229] / [3GPP2 X.S0013.4] with the clarifications given in this subclause.

7.3.2.2a Automatic-answer

Upon receiving an initial SIP INVITE request for which the Automatic Answer Mode is selected, the PoC Server:

- 1. SHALL perform the actions specified in subclause 7.3.2.2.2 "*Automatic answer using the Pre-established Session*" using an existing Pre-established Session, if
 - a) the Invited PoC Client has one or more Pre-established Sessions without an associated PoC Session;
 - b) either of the following is satisfied:
 - i. the incoming SIP INVITE request includes Contact header with the PoC Discrete Media feature tag '+g.poc.discretedia' and the invited PoC Client included the PoC Discrete Media feature tag '+g.poc.discretedia' in Contact header of the existing Pre-established Session; or,
 - ii. the incoming SIP INVITE request does not include Contact header with the PoC Discrete Media feature tag '+g.poc.discretedia';
 - and,
 - c) the offered Media Streams and the offered Media-floor Control Entities are same or subset of those in the existing Pre-established Session.
 - i. the Media-floor Control Entity binding of each offered Media Stream is the same as the Media-floor Control Entity binding of the Media Stream of the same Media Type in the existing Pre-established Session; and,
 - ii. the codecs, Media formats and Media Parameters of each offered Media Stream are compliant with the codecs, Media formats and Media Parameters of the Media Stream of the same Media Type in the existing Pre-established Session.
- Otherwise, continue with the rest of the steps; and,
- 2. SHALL perform the actions specified in subclause 7.3.2.2.1 "*Automatic answer Using On-demand Session*".

When the SIP/IP Core corresponds with 3GPP/3GPP2 IMS, the PoC Server SHALL use 3GPP/3GPP2 IMS Session establishment mechanisms according to rules and procedures of [TS24.229] / [3GPP2 X.S0013.4] with the clarifications given in this subclause.

7.3.2.2b Manual-answer

Upon receiving an initial SIP INVITE request for which the Manual Answer Mode is selected, the PoC Server:

- 1. SHALL perform the actions specified in subclause 7.3.2.2.4 "*Manual answer Using Pre-established Session*" using an existing Pre-established Session, if
 - a) the Invited PoC Client has one or more Pre-established Sessions without an associated PoC Session;
 - b) either of the following is satisfied:
 - i. the incoming SIP INVITE request includes Contact header with the PoC Discrete Media feature tag '+g.poc.discretedia' and the invited PoC Client included the PoC Discrete Media feature tag '+g.poc.discretedia' in Contact header of the existing Pre-established Session; or,
 - ii. the incoming SIP INVITE request does not include Contact header with the PoC Discrete Media feature tag '+g.poc.discretedia';
 - and,
 - c) the offered Media Streams and the offered Media-floor Control Entities are same or subset of those in the existing Pre-established Session.
 - i. the Media-floor Control Entity binding of each offered Media Stream is the same as the Media-floor Control Entity binding of the Media Stream of the same Media Type in the existing Pre-established Session.
 - d) the PoC Server and the Invited PoC Client support Manual Answer Mode using the Pre-established Sessions.

Otherwise, continue with the rest of the steps; and,

- 2. SHALL perform the actions specified in subclause 7.3.2.2.3 "*Manual answer Using On-demand Session*".

When the SIP/IP Core corresponds with 3GPP/3GPP2 IMS, the PoC Server SHALL use 3GPP/3GPP2 IMS Session establishment mechanisms according to rules and procedures of [TS24.229] / [3GPP2 X.S0013.4] with the clarifications given in this subclause.

7.3.2.2.1 Automatic-answer using On-demand Session

The PoC Server SHALL act as B2BUA.

NOTE 1: In this version of the PoC Enabler the PoC Server acts as B2BUA.

The PoC Server:

- 1. SHALL generate a SIP 183 "Session Progress" response to the SIP INVITE request as specified in subclause 7.3.2.1 "*General*" and according to rules and procedures of [RFC3261] and [RFC3262];
- 2. MAY include a Require header set to '100rel' according to rules and procedures of [RFC3262];
- 3. SHALL include the P-Answer-State header set to "Unconfirmed"; and,
- 4. SHALL send the SIP 183 "Session Progress" response towards the PoC Server performing the Controlling PoC Function according to rules and procedures of SIP/IP Core.
- 5. SHALL generate a SIP INVITE request as specified in subclause 7.3.2.1 "*General*";
- 6. SHALL set the Request-URI to the PoC Address of the PoC User to be invited;
- 7. SHALL include a Priv-Answer-Mode header with the value 'Auto', if the received SIP INVITE request contained a Priv-Answer-Mode header with the value set to 'Auto';
- 8. SHALL include an Answer-Mode header with the value set to 'Auto', if the received SIP INVITE request did not contain a Priv-Answer-Mode header;
- 9. SHALL include in the SIP INVITE request a MIME SDP body as an SDP offer based on the SDP offer in the received SIP INVITE request as specified in the subclause 7.3.2.1a "*SDP offer generation*";
- 10. SHALL, in the establishment of an Ad-hoc PoC Group Session and 1-1 PoC session, and if the invited parties identity information feature is supported by PoC Service Provider's policy and Invited Parties Identity Information Mode setting is set to 'true';
 - a) include in the SIP INVITE request the MIME resource-lists body according to rules and procedures of [draft-URI-list]; and;
 - b) perform procedures of [draft-URI-list-capacity] including the addition of the "count" attribute, relying on the "copyControl" and the "anonymize" attribute values in the list;

NOTE 2: If Invited Parties Identity Information Mode setting is set to 'false' or not available in the PoC Server, the PoC Server does not include the identity information in the SIP INVITE request. The URIs without both the "copyControl" and the "anonymize" attributes are interpreted as their "anonymize" attribute value has been set to 'true'.

NOTE 3: The "copyControl" value is not required to be presented to the PoC Users.

- 11. SHALL include the Referred-By header from the incoming SIP request if anonymity is not requested by the value 'id' in the Privacy header; and,
- 12. SHALL send the SIP INVITE request towards the PoC Client according to rules and procedures of the SIP /IP Core.

Upon receiving a SIP 200 "OK" response to the SIP INVITE, the PoC Server:

- 1. SHALL perform actions to authorize the requested Local QoE Profile, as specified in subclause 5.8 "*QoE Profiles*", if QoE Profiles are enabled and a QoE Profile attribute is included in the received SDP answer. If the requested Local QoE Profile is authorized, the PoC Server SHALL assign and cache the requested Local QoE

Profile as the Local QoE Profile for PoC User in the PoC Session and continue with step2. If the QoE Profile is not authorized, the PoC Server:

- a) SHALL respond with a SIP 403 "Forbidden" response with the warning text set to '115 <RequestedQoE> QoE Profile not authorized' as specified in subclause 5.6 "Warning header";
 - b) SHALL generate a SIP BYE request according to rules and procedures of [RFC3261]; and,
 - c) SHALL send the SIP BYE request towards the Invited PoC Client according to rules and procedures of the SIP/IP Core, and do not continue with the rest of steps;
- 2. Depending, according to rules and procedures of [RFC3261] and [RFC3262], on if the SIP 183 "Session Progress" was sent reliable or not as follows:
 - a) SHALL send the SIP 200 "OK" response immediately, if the SIP 183 "Session Progress" was sent unreliable (since the PoC Server does not have to wait for a SIP PRACK request); and,
 - b) SHALL send the SIP 200 "OK" according to rules and procedures of [RFC3262] and [RFC3261], if the SIP 183 "Session Progress" was sent reliable.

If the SIP INVITE transaction times out, and the PoC Server supports PoC Box functionality, the PoC Server SHALL determine whether to route the SIP INVITE request to a PoC Box as specified in subclause 7.3.2.2.5.2. "Determination of routing to a NW PoC Box upon failure to receive a valid SIP 2xx response".

Upon receiving a SIP PRACK request the PoC Server:

- 1. SHALL generate a SIP 200 "OK" response to the SIP PRACK request according to rules and procedures of [RFC3262] and [RFC3261]; and,
- 2. SHALL send the SIP 200 "OK" response towards the PoC Server performing the Controlling PoC Function according to the rules and procedures of SIP/IP Core.

Whenever the PoC Server sends the SIP 200 "OK" response the PoC Server:

- 1. SHALL generate a 200 "OK" response as described in the sub-clause 7.3.2.1 "General";
- 2. SHALL include in the SIP 200 "OK" response a MIME SDP body with an SDP answer based on the SDP answer in the received SIP 200 "OK" response as specified in 7.3.2.1b "SDP answer generation in case of On-demand session";
- 3. SHALL include in the Contact header the feature tag '+g.poc.fdcfo', as specified subclause E.2.4 "FDCFO Proceed Feature Tag", if the PoC Server supports the FDCFO Proceed feature, and the SIP 200 "OK" response from the PoC Client contains this feature tag;
- 4. SHALL include in the Contact header the feature tag '+g.poc.interworking', as specified subclause E.2.5.6 "PoC Interworking Service" if the PoC Server supports the PoC Interworking Service, and the SIP 200 "OK" response from the PoC Client contains this feature tag;
- 5. SHALL interact with the User Plane as specified in [OMA-PoC-UP] "Participating PoC Function procedures at PoC Session initialization", and,
- 6. SHALL send the SIP 200 "OK" response towards the PoC Server performing the Controlling PoC Function according to rules and procedures of SIP/IP Core;

The PoC Server SHALL forward any other SIP response that does not contain SDP along the signalling path to the originating network according to rules and procedures of SIP/IP Core.

When the SIP/IP Core corresponds with 3GPP/3GPP2 IMS, the PoC Server SHALL use 3GPP/3GPP2 IMS session establishment mechanisms according to rules and procedures of [TS24.229] / [3GPP2 X.S0013.4] with the clarifications given in this subclause.

7.3.2.2.2 Automatic-answer using Pre-established Session

The PoC Server SHALL act as B2BUA.

The PoC Server:

- 1. SHALL validate that the Media Parameters are acceptable for the PoC Server and if not reject the request with a SIP 488 "Not Acceptable Here" response. Otherwise, continue with the rest of the steps;

- 2. SHALL check whether the incoming SIP INVITE request from the Controlling PoC Function includes an Accept-Contact header with the PoC Dispatcher feature tag '+g.poc.dispatcher' along with 'require' and 'explicit' parameters. If it is included and the PoC Client did not include the PoC Dispatcher feature tag '+g.poc.dispatcher' during the Pre-established Session establishment, as specified subclause 7.3.1.2 "*Pre-established Session*", the PoC Server SHALL reject the incoming SIP INVITE request with a SIP 480 "Temporarily Unavailable" response with the warning text set to '117 Client not supporting the PoC Dispatcher capability' as specified in subclause 5.6 "*Warning header*" and not continue with the rest of the steps;
- 3. SHALL generate a SIP 200 "OK" response to the SIP INVITE request as described in the subclause 7.3.2.1 "*General*";
- 4. SHALL include in the SIP 200 "OK" response a MIME SDP body as an SDP answer as specified in the subclause 7.3.2.1c "*SDP answer generation in case of Pre-established Session*" based on the SDP negotiated during the Pre-established Session establishment as specified subclause 7.3.1.2 "*Pre-established Session*" and SDP offer received from the PoC Server in the SIP INVITE request;
- 5. SHALL include the P-Answer-State header set to "Unconfirmed";
- 6. SHALL include value 'id' in the Privacy header according to rules and procedures of [RFC3325], if the Invited PoC Client has requested privacy, when the Pre-established Session was established;
- 7. SHALL include the PoC Dispatcher feature tag '+g.poc.dispatcher' in the Contact header of the SIP 200 "OK" response if the incoming SIP INVITE request from the Controlling PoC Function included an Accept-Contact header with the PoC Dispatcher feature tag '+g.poc.dispatcher' along with 'require' and 'explicit' parameters.
- 8. SHALL include in the Contact header the feature tag '+g.poc.fdcfo', as specified subclause E.2.4 "*FDCFO Proceed Feature Tag*", if PoC Server supports the FDCFO Proceed feature, and the SIP INVITE request of the Pre-established Session, as specified in subclause 7.3.1.2 "*Pre-established Session*", contained this feature tag;
- 9. SHALL send the SIP 200 "OK" response to the SIP INVITE request according to rules and procedures of SIP/IP Core;
- 10. SHALL interact with the User Plane as described in [OMA-PoC-UP] "*Participating PoC Function procedure at initialization*"; and,
- 11. SHALL send the SIP 200 "OK" Response to the SIP INVITE request according to rules and procedures of SIP/IP Core.

If the PoC Server has not reached the Invited PoC Client as specified in [OMA-PoC-UP] "*T15 (Connect message re-transmit) timer fired N times*" and the PoC Server supports PoC Box functionality, the PoC Server SHALL determine whether to route the SIP INVITE request to a PoC Box as specified in subclause 7.3.2.2.5.2. "*Determination of routing to a NW PoC Box upon failure to receive a valid SIP2xx response*".

When the SIP/IP Core corresponds with 3GPP/3GPP2 IMS, the PoC Server SHALL use 3GPP/3GPP2 IMS Session establishment mechanisms according to rules and procedures of [TS24.229] / [3GPP2 X.S0013.4] with the clarifications given in this subclause.

7.3.2.2.3 Manual-answer using On-demand Session

The PoC Server:

- 1. SHALL determine if the PoC Server acts as a B2BUA and stays on the Media path or not, as specified in [OMA-PoC-UP] "*User Plane routing*";
- 2. SHALL perform the following actions, if the PoC Server acts as a B2BUA and stays on the media path:
 - a) generate a SIP INVITE request as specified in subclause 7.3.2.1 "*General*".
 - b) include in the SIP INVITE request a MIME SDP body as an SDP offer on the SDP offer in the received SIP INVITE request as specified in the subclause 7.3.2.1a "*SDP offer generation*";
 - c) set the Request-URI to the PoC Address of the PoC User to be invited; and,
 - d) continue, for the duration of the SIP Session, acting as a B2BUA according to rules and procedures of [RFC3261].
- 3. SHALL perform the following actions, if the PoC Server does not stay in the media path:
 - a) for the duration of the SIP Session and as long as the PoC Client is a Participant in the PoC Session, act as a SIP proxy according to rules and procedures of [RFC3261];

- b) use the content of the received SIP INVITE to generate the SIP INVITE request according to rules and procedures of [RFC3261]; and,
- c) include a Record-Route header containing a URI identifying its own address.
- 4. SHALL include the Answer-Mode header set to 'Manual;Require';
- 5. SHALL include the Referred-By header from the incoming SIP request if anonymity is not requested by the value 'id' in the Privacy header;
- 6. SHALL, in the establishment of an Ad-hoc PoC Group Session and 1-1 PoC Session, and if the invited parties identity information feature is supported by PoC Service Provider's policy and Invited Parties Identity Information Mode setting is set to 'true';
 - a) include in the SIP INVITE request the MIME resource-lists body according to rules and procedures of [draft-URI-list]; and,
 - b) perform procedures of [draft-URI-list-capacity] including the addition of the "count" attribute, relying on the "copyControl" and the "anonymize" attribute values in the list.

NOTE 1: If Invited Parties Identity Information Mode setting is set as 'false' or not available in the PoC Server, the PoC Server does not include the identity information in the SIP INVITE request. The URIs without both the "copyControl" and the "anonymize" attributes are interpreted as their "anonymize" attribute value has been set to 'true'.

NOTE 2: The "copyControl" value is not required to be presented to the PoC Users.

- 7. SHALL send the SIP INVITE request towards the PoC Client according to rules and procedures of the SIP/IP Core.

Upon receiving a SIP 180 "Ringing" response to the SIP INVITE request the PoC Server:

- 1. SHALL cache the list of supported SIP methods if received in the Allow header;
- 2. SHALL cache the contact if received in the Contact header;
- 3. SHALL generate a SIP 180 "Ringing" response as specified in subclause 7.3.2.1 "General" if acting as a B2BUA;
- 4. SHALL generate a SIP 180 "Ringing" response according to rules and procedures of [RFC3261] if acting as a SIP proxy; and,
- 5. SHALL send the SIP 180 "Ringing" response towards the PoC Server performing the Controlling PoC Function according to rules and procedures of SIP/IP Core;

Upon receiving a SIP 200 "OK" response to the SIP INVITE request the PoC Server:

- 1. SHALL perform the following actions, if the PoC Server acts as B2BUA
 - a) cache the list of supported SIP methods if received in the Allow header;
 - b) cache the contact received in the Contact header;

NOTE 3: If the maximum number of Simultaneous PoC Sessions is exceeded, the PoC Server handles according to the local policy.

c) SHALL perform actions to authorize the requested Local QoE Profile, as specified in subclause 5.8 "QoE Profiles" if QoE Profiles are enabled and a QoE Profile attribute is included in the received SDP answer. If the requested Local QoE Profile is authorized, the PoC Server SHALL assign and cache the requested Local QoE Profile as the Local QoE Profile for PoC User in the PoC Session, and continue with step e. If the QoE Profile is not authorized, the PoC Server:

- i. SHALL respond with a SIP 403 "Forbidden" response with the warning text set to '115 <RequestedQoE> QoE Profile not authorized' as specified in subclause 5.6 "Warning header" towards the Inviting PoC Client;
- ii. SHALL interact with User Plane as specified in [OMA-PoC-UP] "Participating PoC Function procedures at PoC Session release";
- iii. SHALL generate a SIP BYE request according to rules and procedures of [RFC3261]; and,

- iv. SHALL send the SIP BYE request towards the Invited PoC Client according to rules and procedures of the SIP/IP Core, and do not continue with the rest of steps;
 - d) generate a SIP 200 "OK" response as specified in the subclause 7.3.2.1 "General";
 - e) include in the SIP 200 "OK" response a MIME SDP body as the SDP answer the SDP offer received from the PoC Server in the SIP INVITE request as specified in the subclause 7.3.2.1b "SDP answer generation in case of On-demand session"; and,
 - f) interact with the User Plane as specified in [OMA-PoC-UP] "Participating PoC Function procedures at PoC Session initialization".
- 2. SHALL perform the following actions, if the PoC Server acts as a SIP proxy
 - a) generate a SIP 200 "OK" response according to rules and procedures of [RFC3261]; and,
 - b) include the same MIME SDP body as the SDP answer received in the SIP 200 "OK" response.
 - 3. SHALL include in the Contact header the feature tag '+g.poc.fdcfo', as specified subclause E.2.4 "FDCFO Proceed Feature Tag", if the PoC Server supports the FDCFO Proceed feature, and the SIP 200 "OK" response from the PoC Client contains this feature tag;
 - 4. SHALL include in the Contact header the feature tag '+g.poc.interworking', as specified subclause E.2.5.6 "PoC Interworking Service", if the PoC Server supports the PoC Interworking Service, and the SIP 200 "OK" response from the PoC Client contains this feature tag; and,
 - 5. SHALL send the SIP 200 "OK" response to the PoC Server performing the Controlling PoC Function according to rules and procedures of SIP/IP Core.

If the SIP INVITE transaction times out and the PoC Server supports PoC Box functionality, the PoC Server SHALL determine whether to route the SIP INVITE request to a PoC Box as specified in subclause 7.3.2.2.5.2. "Determination of routing to a NW PoC Box upon failure to receive a valid SIP2xx response".

The PoC Server SHALL forward any other SIP response that does not contain SDP along the signalling path to the originating network according to rules and procedures of SIP/IP Core.

When the SIP/IP Core corresponds with 3GPP/3GPP2 IMS, the PoC Server SHALL use 3GPP/3GPP2 IMS session establishment mechanisms according to rules and procedures of [3GPP TS 24.229] / [3GPP2 X.S0013.4] with the clarifications given in this subclause.

7.3.2.2.4 Manual-answer using Pre-established Session

NOTE: If the PoC Server determines to route the SIP INVITE request to a UE PoC Box Manual Answer using an On-demand Session is used.

The PoC Server SHALL act as B2BUA.

Upon receiving an incoming SIP INVITE from the PoC Server performing Controlling PoC function, the PoC Server

- 1. SHALL generate SIP re-INVITE request as described in subclause 7.3.2.1 "General";

NOTE 1: A SIP re-INVITE request cannot include an Answer-Mode header as specified in [draft-answer-mode] so Manual Answer is implied with a SIP re-INVITE request within the existing SIP dialog of the Pre-established Session.

- 2. SHALL set the Request-URI to the PoC Address of the PoC User to be invited;
- 3. SHALL include Call-ID, From tag and To tag which are provided from Pre-established Session;
- 4. SHALL include in a Contact header conference URI which identifies Pre-established Session;
- 5. SHALL include the Referred-By header from the incoming SIP INVITE request if anonymity is not requested by the value 'id' in the Privacy header.
- 6. SHALL include in the SIP re-INVITE request a MIME SDP body as an SDP offer on the SDP offer in the received SIP INVITE request as specified in the subclause 7.3.2.1a "SDP offer generation";

- 7. SHALL, in the establishment of an Ad-hoc PoC Group Session and 1-1 PoC session, and if the invited parties identity information feature is supported by PoC Service Provider's policy and Invited Parties Identity Information Mode setting is set to 'true';
 - a) include in the SIP re-INVITE request the MIME resource-lists body according to rules and procedures of [draft-URI-list]; and,
 - b) perform procedures of [draft-URI-list-capacity] including the addition of the "count" attribute, relying on the "copyControl" and the "anonymize" attribute values in the list.

NOTE 2: If Invited Parties Identity Information Mode setting is set to 'false' or not available in the PoC Server, the PoC Server does not include the identity information in the SIP INVITE request. The URIs without both the "copyControl" and the "anonymize" attributes are interpreted as if their "anonymize" attribute value has been set to 'true'.

NOTE 3: The "copyControl" value is not required to be presented to the PoC Users.

- 8. SHALL send the SIP re-INVITE request toward the terminating PoC Client within the existing SIP dialog according to rules and procedures of the SIP/IP Core.

Upon receiving a SIP 180 "Ringing" response to the SIP re-INVITE request, the PoC Server:

- 1. SHALL store the list of supported SIP methods if received in the Allow header;
- 2. SHALL generate a SIP 180 "Ringing" response as specified in subclause 7.3.2.1 "General" if acting as a B2BUA; and,
- 3. SHALL send the SIP 180 "Ringing" response towards the PoC Server performing the Controlling PoC Function according to rules and procedures of SIP/IP Core;

Upon receiving a SIP 200 "OK" response to the SIP re-INVITE request, the PoC Server:

- 1. SHALL interact with the User Plane as specified in [OMA-PoC-UP] "*User Plane adaptation*" for updating the User Plane with the newly negotiated codecs and Media Parameters from the received SDP answer, if the received SDP answer includes changes in codecs or Media formats or Media Parameters from those earlier accepted;
- 2. SHALL interact with the User Plane as specified in [OMA-PoC-UP] "*Participating PoC Function procedures when disconnecting from a Media*", if a Media Stream previously negotiated in the Pre-established Session was marked as rejected in the received SDP answer;
- 3. SHALL generate a SIP 200 "OK" response as described in the subclause 7.3.2.1 "General";
- 4. SHALL include in the SIP 200 "OK" response, a MIME SDP body with an SDP answer based on the SDP answer in the received SIP 200 "OK" response, as specified in 7.3.2.1b "*SDP answer generation in case of On-demand session*";
- 5. SHALL include in the Contact header the feature tag '+g.poc.fdcfo', as specified subclause E.2.4 "*FDCFO Proceed Feature Tag*", if PoC Server supports the FDCFO Proceed feature, and the SIP 200 "OK" response from the PoC Client contains this feature tag;
- 6. SHALL interact with the User Plane as described in [OMA-PoC-UP] "*Participating PoC Function procedures at PoC Session initialization*"; and,

NOTE 4: The PoC Server sends a MBCP Connect message, in order to give PoC Session Identity to the terminating PoC Client.

- 7. SHALL send the SIP 200 "OK" Response to the SIP INVITE request according to rules and procedures of SIP/IP Core.

If the SIP INVITE transaction times out and the PoC Server supports PoC Box functionality, the PoC Server SHALL determine whether to route the SIP INVITE request to a PoC Box as specified in subclause 7.3.2.2.5.2. "*Determination of routing to a NW PoC Box upon failure to receive a valid SIP2xx response*".

When the SIP/IP Core corresponds with 3GPP/3GPP2 IMS, the PoC Server SHALL use 3GPP/3GPP2 IMS Session establishment mechanisms according to rules and procedures of [3GPP TS 24.229] / [3GPP2 X.S0013.4] with the clarifications given in this subclause.

7.3.2.2.5 Forward invitation to a PoC Box

7.3.2.2.5.1. Determination of routing to a PoC Box upon an incoming invitation

This subclause specifies how the PoC Server supporting the PoC Box service determines whether to route an incoming SIP request to a NW PoC Box or a UE PoC Box before attempting to route the SIP request to the PoC Client.

Upon receiving an initial SIP INVITE request the PoC Server:

- 1. SHALL determine not to route the SIP INVITE request to a
 - a) NW PoC Box if the SIP INVITE request received from the Inviting PoC Client contains a Reject-Contact header containing the feature tags 'sip.automata' and 'sip.actor' with the value 'msg-taker' along with the parameters 'require' and 'explicit'; or,
 - b) UE PoC Box if the SIP INVITE request received from the Inviting PoC Client contains a Reject-Contact header containing the feature tags 'sip.automata' and 'sip.actor' with the value 'principal' and 'sip.description' with the value "poc recording device" along with the parameters 'require' and 'explicit'.

If neither a NW PoC Box nor a UE PoC Box can be routed, do not continue with the rest of the steps.

- 2. SHALL determine not to route the request to a NW PoC Box nor a UE PoC Box if the PoC Service Setting PoC Box Use is set to "unwillingness", and do not continue with the rest of the steps;
- 3. SHALL determine that the incoming SIP INVITE request is to be routed to the UE PoC Box if the PoC Service Setting PoC Box Use is not set to "unwillingness" and the SIP INVITE request received from the Inviting PoC Client contains an Accept-Contact header containing the feature tags 'sip.automata' and 'sip.actor' with the value 'principal' and 'sip.description' with the value "poc recording device" along with the parameters 'require' and 'explicit', and the <pocbox-type> element is set to "uepocbox" and do not continue with the rest of the steps;
- 4. SHALL determine that the incoming SIP INVITE request is to be routed to the NW PoC Box if the PoC Service Setting PoC Box Use is not set to "unwillingness" and the SIP INVITE request received from the Inviting PoC Client contains an Accept-Contact header containing the feature tags 'sip.automata' and 'sip.actor' with the value 'msg-taker' along with the parameters 'require' and 'explicit', and the <pocbox-type> element is set to "nwpoebox" and do not continue with the rest of the steps;
- 5. SHALL determine that the incoming SIP INVITE request is to be routed to
 - a) the NW PoC Box if the PoC Service Setting PoC Box Use is set to "unconditional" and if the <pocbox-type> element is set to "nwpoebox"; or,
 - b) the UE PoC Box if the PoC Service Setting PoC Box Use is set to "unconditional" and if the <pocbox-type> element is set to "uepocbox".

7.3.2.2.5.2. Determination of routing to a NW PoC Box upon failure to receive a valid SIP 2xx response

This subclause specifies how the PoC Server supporting the PoC Box service determines whether to route request to a NW PoC Box after failing to receive a valid SIP 2xx final response from the PoC Client or from the UE PoC Box.

Upon receiving a SIP 302 "Moved Temporarily" response to the SIP INVITE request from the Invited PoC Client the PoC Server:

- 1. SHALL check if the address received in the Contact header corresponds to the NW PoC Box address and if not return a SIP 486 "Busy Here" response and do not continue with the rest of the steps;
- 2. SHALL return a SIP 486 "Busy Here" response if the original SIP INVITE request received from the Inviting PoC Client contains a Reject-Contact header containing the feature tag 'sip.automata' and the feature tag 'sip.actor' with the value of 'msg-taker' along with the parameters 'require' and 'explicit' and do not continue with the rest of the steps; or,
- 3. SHALL route the original Incoming SIP INVITE Request to the NW PoC Box as specified in subclause 7.3.2.2.5.3 "Forward invitations to a NW PoC Box" if the PoC Server supports the PoC Box and the Invited PoC User subscribes to the NW PoC Box service.

NOTE: The SIP INVITE request is forwarded to the NW PoC Box even if the PoC Service Setting PoC Box Use indicates "unwillingness" as this is upon the specific decision of the PoC User.

Upon an expiration of the 'PoC Box Alert User Timer' or upon failing to receive a final response or receiving any SIP 4xx, 5xx or 6xx response to the SIP INVITE request from the PoC Client or UE PoC Box the PoC Server:

- 1. SHALL if the original SIP INVITE request received from the Inviting PoC Client contains a Reject-Contact header containing only the feature tag 'sip.automata' and the feature tag 'sip.actor' with the value of 'msg-taker' along with the parameters 'require' and 'explicit' either
 - a) Forward the SIP 4xx, 5xx or 6xx response, or,
 - b) If no response was received return an appropriate SIP 408 "Request Timeout" response;
 and do not continue with the rest of the steps;
- 2. SHALL if the PoC Service Setting PoC Box Use is not set to "unwillingness", and the PoC Server supports the NW PoC Box and the Invited PoC User subscribes to the NW PoC Box service then route the original incoming SIP INVITE request to the NW PoC Box as specified in subclause 7.3.2.2.5.3 "Forward invitations to a NW PoC Box" and do not continue with the rest of the steps; or.
- 3. SHALL if the PoC Server determines that the incoming SIP INVITE request is not to be redirected to the NW PoC Box based upon the above steps then the PoC Server either:
 - a) Forward the response received from the PoC Client or UE PoC Box; or
 - b) If no response was received return an appropriate SIP 408 "Request Timeout" response.

When the SIP/IP Core corresponds with 3GPP/3GPP2 IMS, the PoC Server SHALL use 3GPP/3GPP2 IMS mechanisms according to rules and procedures of [3GPP TS 24.229] / [3GPP2 X.S0013.4] with the clarifications given in this subclause.

7.3.2.2.5.3. Forward invitations to a NW PoC Box

When an invitation to a PoC Session is to be forwarded to the NW PoC Box the PoC Server:

- 1. SHALL perform the following steps in case of the unregistered case:
 - a) MAY reject the SIP INVITE request with a SIP 503 "Service Unavailable" response depending on the value of the requested QoE Profile if QoE Profiles are enabled, the PoC Server is acting as a B2BUA and a risk of congestion exists as specified in [OMA-PoC-UP] "*Procedures at the PoC Server performing the Participating PoC Function*". The PoC Server MAY include a Retry-After header to the 503 "Service Unavailable" response as specified in [RFC3261];
 - b) SHALL check the presence of the 'isfocus' feature parameter in the URI of the Contact header and if it is not present then the PoC Server SHALL reject the request with a SIP 403 "Forbidden" response with the warning text set to '106 Isfocus not assigned' as specified in subclause 5.6 "*Warning header*". Otherwise continuing the rest of the steps;
 - c) SHALL check the Invited PoC User's PoC Service Settings associated to the PoC Address received in the Request-URI. If the PoC Service Settings have not been received from the PoC Client yet or if PoC Service Settings expiration timer has expired, the PoC Server SHALL respond with a SIP 480 "Temporarily Unavailable" response. Otherwise continue with the rest of the steps;
 - d) SHALL check if the Authenticated Originator's PoC Address and the URI of Referred-By header in the initial SIP INVITE request is not 'true' in the <allow-reject-invite> action associated to the Invited PoC User indicated by the Request-URI as described in [OMA-PoC-Document-Mgmt]. If at least one of them is 'true' then the PoC Server SHALL respond with a SIP 403 "Forbidden" response with the warning text set to '121 Function not allowed due to <detailed reason>' as specified in subclause 5.6 "*Warning header*". Otherwise continue with the rest of the steps
- 2. MAY respond with a SIP 480 "Temporarily Unavailable" response according to local policy, if the MIME message/sipfrag body containing the User-Agent header indicating the Inviting PoC Client compliant only to the OMA PoC version 1.0 specification as specified in subclause E.4.1 "*Release version in User-agent and Server headers*" is included in the received SIP INVITE request and the regional and national regulations require that the Inviting PoC User is informed about recording before being recorded. Otherwise continue with the rest of the steps.
- 3. SHALL generate a SIP INVITE request as specified in subclause 7.3.2.1 "*General*";
- 4. SHALL include the address of a NW PoC Box along with the called PoC User's PoC Address and the cause for the redirection in the Request-URI according to rules and procedures of [RFC 4458];
- 5. SHALL include a History-Info header as specified in [RFC 4244] giving the condition for forwarding the invitation to the NW PoC Box;

- 6. SHALL include in the SIP INVITE request a MIME SDP body as specified in the subclause 7.3.2.1a "*SDP offer generation*";
- 7. SHALL include the Answer-Mode header set to 'Manual;Require';
- 8. SHALL include the Referred-By header from the incoming SIP request;
- 9. SHALL continue, for the duration of the SIP Session, acting as a B2BUA according to rules and procedures of [RFC3261]; and,
- 10. SHALL forward the incoming SIP INVITE request towards the NW PoC Box according to rules and procedures of SIP/IP Core.

Upon receiving a SIP 200 "OK" response to the SIP INVITE request the PoC Server:

- 1. SHALL perform the following actions
 - a) cache the list of supported SIP methods if received in the Allow header; and,
 - b) cache the contact received in the Contact header.
- 2. SHALL include in the Contact header the feature tags 'sip.automata', and the feature tag 'sip.actor' with the value of 'msg-taker' if any of these are included in the Contact header of the incoming received SIP response; and,
- 3. SHALL send the SIP 200 "OK" response to the PoC Server performing the Controlling PoC Function according to rules and procedures of SIP/IP Core.

The PoC Server SHALL forward any other SIP response that does not contain SDP along the signalling path to the originating network according to rules and procedures of SIP/IP Core.

When the SIP/IP Core corresponds with 3GPP/3GPP2 IMS, the PoC Server SHALL use 3GPP/3GPP2 IMS session establishment mechanisms according to rules and procedures of [3GPP TS 24.229] / [3GPP2 X.S0013.4] with the clarifications given in this subclause.

7.3.2.2.5.4. Forward invitations to a UE PoC Box

When an invitation to a PoC Session is to be forwarded to the UE PoC Box

The PoC Server:

- 1. SHALL respond with a SIP 480 "Temporarily Unavailable" response, if the MIME message/sipfrag body containing the User-Agent header indicating the Inviting PoC Client compliant only to the OMA PoC version 1.0 specification as specified in subclause E.4.1 "*Release version in User-agent and Server headers*" is included in the received SIP INVITE request and the regional and national regulations require that the Inviting PoC User is informed about recording before being recorded. Otherwise continue with the rest of the steps.
- 2. SHALL generate a SIP INVITE request as specified in subclause 7.3.2.1 "*General*";
- 3. SHALL include in the SIP INVITE request a MIME SDP body as specified in the subclause 7.3.2.1a "*SDP offer generation*";
- 4. SHALL set the Request-URI to the PoC Address of the PoC User to be invited;
- 5. SHALL include in the Accept-Contact header the feature tag 'sip.automata' along with the feature tags 'sip.actor' with the value 'principal' and 'sip.description' with the value "poc recording device" and the parameters 'explicit' and 'require';
- 6. SHALL include unmodified any Reject-Contact headers contained in the original SIP INVITE request;
- 7. SHALL include the Answer-Mode header set to 'Manual;Require';
- 8. SHALL include the Referred-By header from the incoming SIP request if anonymity is not requested by the value 'id' in the Privacy header;
- 9. SHALL, in the establishment of an Ad-hoc PoC Group Session and 1-1 PoC session, and if the invited parties identity information feature is supported by PoC Service Provider's policy and Invited Parties Identity Information Mode setting is set to 'true';
 - a) include in the SIP INVITE request the MIME resource-lists body according to rules and procedures of [draft-URI-list]; and,
 - b) perform procedures of [draft-URI-list-capacity] including the addition of the "count" attribute, relying on the "copyControl" and the "anonymize" attribute values in the list;

NOTE 1: The URIs without both the "copyControl" and the "anonymize" attributes are interpreted as their "anonymize" attribute value has been set to 'true'.

NOTE 2: The "copyControl" value is not required to be presented to the PoC Users.

- 10. SHALL continue, for the duration of the SIP Session, acting as a B2BUA according to rules and procedures of [RFC3261]; and,
- 11. SHALL send the SIP INVITE request towards the UE PoC Box according to rules and procedures of the SIP/IP Core.

Upon receiving a SIP 200 "OK" response to the SIP INVITE request the PoC Server:

- 1. SHALL perform the following actions:
 - a) cache the list of supported SIP methods if received in the Allow header; and,
 - b) cache the contact received in the Contact header;
- 2. SHALL copy into the Contact header the feature tags 'sip.automata', 'sip.actor', 'sip.description' with their corresponding value if any of these are included in the Contact header of the incoming received SIP response; and,
- 3. SHALL send the SIP 200 "OK" response to the PoC Server performing the Controlling PoC Function according to rules and procedures of SIP/IP Core.

Upon receiving any SIP 4xx, 5xx or 2xx response or if no final response is received from the UE PoC Box the PoC Server SHALL determine whether to forward the request to a NW PoC Box as specified in subclause 7.3.2.2.5.2 "*Determination of routing to a NW PoC Box upon failure to receive a valid SIP2xx response*".

When the SIP/IP Core corresponds with 3GPP/3GPP2 IMS, the PoC Server SHALL use 3GPP/3GPP2 IMS session establishment mechanisms according to rules and procedures of [3GPP TS 24.229] / [3GPP2 X.S0013.4] with the clarifications given in this subclause.

7.3.2.3 PoC Session modifications

Upon receiving a SIP UPDATE request or a SIP re-INVITE request and when the PoC Server acts as a B2BUA during an on-going PoC Session the PoC Server:

- 1. SHALL validate that the received SDP offer includes at least one Media Stream for which the Media Parameters and at least one codec or Media format is acceptable to the PoC Server and if not reject the request with a SIP 488 "Not Acceptable Here" response. Otherwise continue with the rest of the steps;
- 2. MAY generate a SIP UPDATE request according to rules and procedures of [RFC3311], if the PoC Server supports the SIP UPDATE request and if
 - a) the PoC Client has indicated support for the SIP UPDATE method;
 - b) the offered Media Streams and the offered Media-floor Control Entities are used in the PoC Session by the PoC Client; and,
 - c) the offered Media-floor Control Entity binding of each Media Stream used and offered is the same as used; and SHALL generate a SIP re-INVITE request according to rules and procedures of [RFC3261], if the SIP UPDATE request is not generated;
- 3. SHALL include the PoC Session Identity in a Contact header when the On-demand Session is used and include conference URI which identifies Pre-established Session when the Pre-established Session is used;
- 4. SHALL include in the SIP request a MIME SDP body as an SDP offer as specified in subclause 7.3.2.1a "*SDP offer generation*";
- 5. SHALL include a Resource-Priority header according to rules and procedures of [RFC4412] that is identical to the one in the incoming SIP UPDATE request or SIP re-INVITE request, if the PoC Server supports 'Official Government Use' QoE Profile and if a Resource-Priority header is included in the incoming SIP UPDATE request or SIP re-INVITE;
- 6. SHALL send the SIP request towards the PoC Client within the existing SIP dialog according to rules and procedures of the SIP/IP Core.

Upon receiving a SIP UPDATE request or a SIP re-INVITE request during an on-going PoC Session and when the PoC Server acts as a SIP proxy the PoC Server SHALL forward the SIP request according to rules and procedures of [RFC3261].

Upon receiving a SIP 180 "Ringing" response to the SIP INVITE request and when the PoC Server acts as a B2BUA, the PoC Server:

- 1. SHALL generate a SIP 180 "Ringing" response as specified in subclause 7.3.2.1 "General"; and,
- 2. SHALL send the SIP 180 "Ringing" response towards the PoC Server performing the Controlling PoC Function according to rules and procedures of SIP/IP Core;

Upon receiving a SIP 200 "OK" response and when the PoC Server acts as a B2BUA the PoC Server:

- 1. SHALL generate a SIP 200 "OK" to the SIP UPDATE request or the SIP re-INVITE request according to rules and procedures of the [RFC3261];
- 2. SHALL include a MIME SDP body in the SIP 200 "OK" response as the SDP answer as specified in subclause 7.3.2.1b "SDP answer generation in case of On-demand session" or as in subclause 7.3.2.1c "SDP answer generation in case of Pre-established Session";
- 3. SHALL interact with the User Plane as specified in [OMA-PoC-UP] "User Plane adaptation" for updating the User Plane with the newly negotiated codecs and Media Parameters from the received SDP answer, if the PoC Server is in the Media path and if the received SDP answer includes changes in codecs or Media formats or Media Parameters from those earlier accepted;
- 4. SHALL interact with the User Plane as specified in [OMA-PoC-UP] "Participating PoC Function procedures when disconnecting from a Media", if the PoC Server is on the Media path and if a Media Stream previously used in the PoC Session was marked as rejected in the received SDP answer or if the PoC Server is in the Media path and if the current Media-floor Control Entity binding of a Media, that is currently used in the PoC Session and accepted in the SDP answer, is not the same as in the received SDP answer;
- 5. SHALL interact with the User Plane as specified in [OMA-PoC-UP] "Participating PoC Function procedures when connecting to a Media", if the PoC Server is in the Media path and if a Media Stream not previously used in the PoC Session was accepted in the received SDP answer or if the PoC Server is in the Media path and if the current Media-floor Control Entity binding of a Media, that is currently used in the PoC Session and accepted in the SDP answer, is not the same as in the received SDP answer; and,
- 6. SHALL send a SIP 200 "OK" response towards the PoC Server performing the Controlling PoC Function according to rules and procedures of SIP/IP Core.

Upon receiving of a SIP 180 "Ringing" response and when the PoC Server acts as a SIP proxy, the PoC Server SHALL forward the SIP 180 "Ringing" response according to rules and procedures of [RFC3261].

Upon receiving a SIP 200 "OK" response and when the PoC Server acts as a SIP proxy the PoC Server SHALL forward the SIP 200 "OK" response according to rules and procedures of [RFC3261].

Upon receiving a SIP final response (with the exception of the SIP 200 "OK" response) to the SIP re-INVITE request or the SIP UPDATE request the PoC Server SHALL forward the SIP final response according to rules and procedures of [RFC3261].

When the SIP/IP Core corresponds with 3GPP/3GPP2 IMS, the PoC Server SHALL use 3GPP/3GPP2 IMS Session mechanisms according to rules and procedures of [3GPP TS 24.229] / [3GPP2 X.S0013.4] with the clarifications given in this subclause.

7.3.2.4 SIP NOTIFY request

If the PoC Server performing the Participating PoC Function receives an incoming SIP NOTIFY request that is part of the same dialog as the previously sent SIP SUBSCRIBE request the PoC Server:

- 1. SHOULD check if a Resource-Priority header is included in the SIP NOTIFY request according to rules and procedures of [RFC4412], if the PoC Server supports 'Official Government Use' QoE Profile, and if included the PoC Server SHALL apply preferential treatment to the SIP NOTIFY request, as specified in [RFC4412];
- 2. SHALL send the SIP NOTIFY request towards the PoC Client along the signalling path; and,
- 3. SHALL forward the response along the signalling path to the originating network when the Invited PoC Client responds and a response is received from the invited PoC Address.

When the SIP/IP Core corresponds with 3GPP/3GPP2 IMS, the PoC Server SHALL use 3GPP/3GPP2 IMS mechanisms and procedures according to rules and procedures of [3GPP TS 24.229] / [3GPP2 X.S0013.4] with the clarifications given in this subclause.

7.3.2.5 SIP CANCEL request

Upon receiving a SIP CANCEL request from the PoC Server performing the Controlling PoC Function, a PoC Server acting as a B2BUA:

- 1. SHALL act as UAS according to rules and procedures of [RFC3261]; and,
- 2. SHALL cancel the SIP INVITE request towards the PoC Client acting as UAC according to rules and procedures of [RFC 3261].

When acting as a SIP proxy the rules and procedures as specified in [RFC3261] SHALL be applied.

When the SIP/IP Core corresponds with 3GPP/3GPP2 IMS, the PoC Server SHALL use 3GPP/3GPP2 IMS mechanisms according to rules and procedures of [3GPP TS 24.229] / [3GPP2 X.S0013.4] with the clarifications given in this subclause.

7.3.2.6 SIP BYE request

7.3.2.6.1 SIP BYE request from the Controlling PoC Function – On-demand Session case

Upon receiving a SIP BYE request from the PoC Server performing the Controlling PoC Function a PoC Server acting as a B2BUA:

- 1. SHOULD check if a Resource-Priority header is included in the SIP BYE request according to rules and procedures of [RFC4412], if the PoC Server supports 'Official Government Use' QoE Profile. If included the PoC Server SHALL apply preferential treatment to the request to leave the PoC Session, as specified in [RFC4412];
- 2. SHALL interact with the User Plane as specified in [OMA-PoC-UP] "*Participating PoC Function procedures at PoC Session release*" for releasing User Plane resource associated with the SIP Session with the PoC Server performing the Controlling PoC Function;
- 3. SHALL generate a SIP 200 "OK" response and send it towards the PoC Server performing the Controlling PoC Function according to rules and procedures of the SIP/IP Core;
- 4. SHALL generate a SIP BYE request according to rules and procedures of [RFC3261];
- 5. SHOULD include a Reason header unmodified according to rules and procedures of [RFC4411], if the incoming SIP BYE request contained a Reason header and if the PoC Server supports the 'Official Government Use' QoE Profile;
- 5. SHALL include a Resource-Priority header unmodified according to rules and procedures of [RFC4412], if the incoming SIP BYE request contained a Resource-Priority header and if the PoC Server supports the 'Official Government Use' QoE Profile; and,
- 6. SHALL send the SIP BYE request to the PoC Client according to rules and procedures of the SIP/IP Core.

Upon receiving a SIP 200 "OK" response to the SIP BYE request the PoC Server SHALL interact with the User Plane as specified in [OMA-PoC-UP] "*Participating PoC Function procedures at PoC Session release*" for releasing User Plane resources associated with the SIP Session with the PoC Client.

When acting as a SIP proxy the rules and procedures as specified in [RFC3261] SHALL be applied.

When the SIP/IP Core corresponds with 3GPP/3GPP2 IMS, the PoC Server SHALL use 3GPP/3GPP2 IMS mechanisms according to rules and procedures of [3GPP TS 24.229] / [3GPP2 X.S0013.4] with the clarifications given in this subclause.

7.3.2.6.2 SIP BYE request from the Controlling PoC Function – Pre-established Session case

NOTE: The procedure in this subclause applies when the PoC Session is established by sending a MBCP message to the PoC Client as specified in [OMA-PoC-UP] "*Participating PoC function procedures at PoC Session initialization*".

Upon receiving a SIP BYE request from the Controlling PoC Function the PoC Server:

- 1. SHOULD check if a Resource-Priority header is included in the SIP BYE request according to rules and procedures of [RFC4412], if the PoC Server supports 'Official Government Use' QoE Profile. If included, the PoC Server SHALL apply preferential treatment to the request to leave the PoC Session, as specified in [RFC4412];
- 2. SHALL interact with the User Plane as specified in [OMA-PoC-UP] "*Participating PoC Function procedures at PoC Session release*" for disconnecting the User Plane resources towards the PoC Server performing Controlling PoC Function;
- 3. SHALL send a SIP 200 "OK" response to the Controlling PoC Function;
- 4. SHALL interact with the User Plane as specified in [OMA-PoC-UP] "*Participating PoC Function procedures at PoC Session release*" for disconnecting User Plane resources towards the PoC Client from the User Plane resources towards the Controlling PoC Function; and,
- 5. SHALL maintain the Pre-established Session towards the PoC Client.

When the SIP/IP Core corresponds with 3GPP/3GPP2 IMS, the PoC Server SHALL use 3GPP/3GPP2 IMS mechanisms according to rules and procedures of [3GPP TS 24.229] / [3GPP2 X.S0013.4] with the clarifications given in this subclause.

7.3.2.6.3 Leaving a PoC Session when using Pre-established Session

NOTE: The procedure in this subclause applies when the PoC Session is established within a Pre-established Session as specified in subclause 6.1.3.2.2 "*PoC Client initiates an Ad-hoc PoC Group Session and 1-1 PoC Session*"; or when the PoC Client releases the proper Pre-established Session as specified in subclause 6.1.3.2.1 "*PoC Client initiates a Pre-established Session*".

The PoC Server:

- 1. SHALL maintain the Pre-established Session towards the PoC Client; and,
- 2. SHALL interact with the User Plane as specified in [OMA-PoC-UP] "*Participating PoC Function procedures at PoC Session release*" for disconnecting User Plane resources towards the PoC Client from the User Plane resources towards the Controlling PoC Function;

When the SIP/IP Core corresponds with 3GPP/3GPP2 IMS, the PoC Server SHALL use 3GPP/3GPP2 IMS mechanisms according to rules and procedures of [3GPP TS 24.229] / [3GPP2 X.S0013.4] with the clarifications given in this subclause.

7.3.2.7 Group Advertisement request

Upon receiving a SIP MESSAGE request containing the PoC feature tag '+g.poc.groupad' in the Accept-Contact header and a PoC Address in the Request-URI served by the PoC Server performing the Participating PoC Function the PoC Server:

- 1. SHALL reject the SIP MESSAGE request with a SIP 403 "Forbidden" response with the warning text set to '121 Function not allowed due to <detailed reason>' as specified in subclause 5.6 "*Warning header*", if Group Advertisement is not supported by the PoC Server. Otherwise, continue with the rest of the steps;
- 2. SHALL check if the Authenticated Originator's PoC Address in the initial SIP MESSAGE request associated to the Invited PoC User indicated by the Request-URI is not 'true' in the <allow-reject-invite> action as described in [OMA-PoC-Document-Mgmt]. If it is 'true', the PoC Server SHALL respond with a SIP 403 "Forbidden" response to the originating network with the warning text set to '121 Function not allowed due to <detailed reason>' as specified in subclause 5.6 "*Warning header*". Otherwise, continue with the rest of the steps;
- 3. SHALL check the total size of text content in the Subject header, if Included Text Content is supported by the PoC Server and if Subject header is included, and if the total size exceeds a configurable max size remove the text content;
- 4. SHALL perform the following actions, if Included Media Content is supported by the PoC Server and if media content is included in one or more MIME bodies:
 - a) check the PoC Service Setting for Included Media Content in a Request Support and if set to 'true' and if at least one Media Type is not allowed according to local policy, based on a Service Provider Policy either,
 - i. send a SIP 415 "Unsupported Media Type" response, the SIP 415 "Unsupported Media Type" response SHALL include:

- 1) the Accept header with the acceptable Media-Types that the PoC Server would accept according to rules and procedures of [RFC3261]; or,
- 2) the Accept-Encoding header with the encoding formats that the PoC Server would accept according to rules and procedures of [RFC3261]; or,
- 3) both

and do not continue with the rest of the steps; or,

- ii. remove all MIME bodies containing not allowed Media Types and continue with the rest of the steps.
 - b) check the total size of all MIME bodies containing media content and if the total size exceeds a configurable max size, based on a Service Provider Policy either,
 - i. send a SIP 413 "Request Entity Too Large" response and do not continue with the rest of the steps; or,
 - ii. remove all MIME bodies containing media content and continue with the rest of the steps.
 - c) check the PoC Service Setting for Included Media Content in a Request Support and if set to 'false' or not set at all and if media content was not removed, remove all MIME bodies containing media content and continue with the rest of the steps.
- 5. SHALL remove the Subject header;
 - 6. MAY remove the Call-Info header;

NOTE: The reason for removing the Subject header and the reason for removing the Call-Info header may be a local policy in the PoC Server.

- 7. SHALL, if Text Content is supported by the PoC Server and if Subject header was not removed and if text content is included in the Subject header, check the PoC Service Setting for Text Content Included in a Request Support and if set to 'false' or not set at all remove the text content;
- 8. SHALL, if Referenced Media Content is supported by the PoC Server and if Call-Info header was not removed and if referenced media content is included in the Call-Info header, check the PoC Service Setting for Referenced Media Content Included in a Request Support and if set to 'false' or not set at all remove the referenced media content; and,
- 9. SHALL forward the SIP MESSAGE request towards the PoC Client according to rules and procedures of the SIP/IP Core.

Upon receiving a SIP response the PoC Server SHALL forward the SIP response according to rules and procedures of [RFC3261].

When the SIP/IP Core corresponds with 3GPP/3GPP2 IMS, the PoC Server SHALL use 3GPP/3GPP2 IMS mechanisms according to rules and procedures of [3GPP TS 24.229] / [3GPP2 X.S0013.4] with the clarifications given in this subclause.

7.3.2.8 Discrete Media request

Upon receiving a SIP MESSAGE request not containing a MIME body of the MIME Type application/vnd.poc.fdcfo+xml either

- 1. outside the SIP dialog used for a PoC Session containing the PoC feature tag '+g.poc.discretedia' in the Accept-Contact header ; or,
- 2. inside the SIP dialog used for the PoC Session,

and a PoC Address in the Request-URI served by the PoC Server performing the Participating PoC Function, the PoC Server:

- 1. SHALL generate the SIP MESSAGE request as specified in [OMA_IM_TS_Endorsement] "*Receiving SIP MESSAGE request*";
- 2. SHALL check if the Authenticated Originator's PoC Address in the initial SIP MESSAGE request is not 'true' in the <allow-reject-invite> action associated to the Invited PoC User indicated by the Request-URI as described in [OMA-PoC-DocMgmt]. If it is 'true', the PoC Server SHALL respond with a SIP 403 "Forbidden" response with the warning text set to '121 Function not allowed due to <detailed reason>' as specified in subclause 5.6 "*Warning header*" to the originating network. Otherwise, continue with the rest of the steps;
- 3. SHALL include in the Accept-Contact header the PoC feature tag '+g.poc.discretedia' according to rules and procedures of [RFC3841] if to be sent outside the SIP dialog used for the PoC Session; and,

- 4. SHALL forward the SIP MESSAGE request
 - a) towards the PoC Box according to rules and procedures of the SIP/IP Core as specified in [OMA_IM_TS_Endorsement] "*Receiving SIP MESSAGE request for Pager mode*" in the SIP dialog used for the PoC Session, if the PoC Session was routed to the PoC Box and if the PoC Box supports Discrete Media; or,

NOTE 1: The selection between the UE PoC Box and the NW PoC Box is made when the PoC Session is established.

- b) towards the PoC Client according to rules and procedures of the SIP/IP Core as specified in [OMA_IM_TS_Endorsement] "*Receiving SIP MESSAGE request for Pager mode*", if not routed to the PoC Box;

NOTE 2: Responses for the SIP MESSAGE requests are described in [OMA_IM_TS_Endorsement].

When the SIP/IP Core corresponds with 3GPP/3GPP2 IMS, the PoC Server SHALL use 3GPP/3GPP2 IMS mechanisms according to rules and procedures of [3GPP TS 24.229] / [3GPP2 X.S0013.4] with the clarifications given in this subclause.

7.3.2.9 FDCFO Proceed request

Upon receiving a SIP MESSAGE request inside the SIP dialog used for the PoC Session with a MIME body of the MIME Type application/vnd.poc.fdcfo+xml and a PoC Address in the Request-URI served by the PoC Server performing the Participating PoC Function, the PoC Server:

- 1. SHALL generate the SIP MESSAGE request according to rules and procedures of [RFC3428];
- 2. SHALL include the Authenticated Originator's PoC Address as specified in subclause 5.2 "*Authenticated Originator's PoC Address*" set to the URI received in the incoming SIP MESSAGE request;
- 3. SHALL include the Privacy header with the value "id" if privacy is requested;
- 4. SHALL include the User-Agent header to indicate the OMA PoC release version of the PoC Server as specified in subclause E.4.1 "*Release version in User-agent and Server headers*";
- 5. SHALL include the MIME application/vnd.poc.fdcfo+xml body received in the incoming SIP MESSAGE request; and,
- 6. SHALL forward the SIP MESSAGE request towards the PoC Client inside the SIP dialog used for the PoC Session according to rules and procedures of the SIP/IP Core;

Upon receiving a SIP final response other than SIP 2xx final response the PoC Server SHALL forward the SIP final response along the signalling path towards the originating PoC Client according to rules and procedures of [RFC3261].

Upon receiving a SIP 2xx final response the PoC Server:

- 1. SHALL generate a SIP final response of the same status code as the received SIP response according to rules and procedures of [RFC3428];
- 2. SHALL include the Server header to indicate the OMA PoC release version of the PoC Server as specified in subclause E.4.1 "*Release version in User-agent and Server headers*"; and,
- 3. SHALL forward the SIP final response along the signalling path towards the originating PoC Client according to rules and procedures of [RFC3261].

When the SIP/IP Core corresponds with 3GPP/3GPP2 IMS, the PoC Server SHALL use 3GPP/3GPP2 IMS mechanisms according to rules and procedures of [TS24.229] / [3GPP2 X.S0013.4] with the clarifications given in this subclause.

7.3.2.10 PoC Server Releases a PoC Session

If the PoC Session to be released uses the On-demand Session, and the PoC Server acts as a B2BUA, then the PoC Server:

- 1. SHALL interact with the User Plane as specified in [OMA-PoC-UP] "*Participating PoC Function procedures at PoC Session release*" for releasing the User Plane resources towards the PoC Client;
- 2. SHALL generate a SIP BYE request according to rules and procedures of [RFC3261];
- 3. SHOULD include a Reason header with text '*Preemption ;cause=1 ; text="UA preemption*', according to [RFC 4411], if the PoC Server supports the 'Official Government Use' QoE Profile and the PoC Session is released due to

the arrival of another PoC Session with 'Official Government Use' QoE Profile. The PoC Server SHOULD choose language of the reason-text in the Reason header depending on the preferred language indicated in Accept-Language header received from the PoC Client in the SIP INVITE request or SIP 200 "OK" response to the SIP INVITE request, if the language is supported;

- 4. SHALL include a Resource-Priority header according to rules and procedures of [RFC4412] that is identical to the one used to establish the PoC Session, if the PoC Session was established with an 'Official Government Use' QoE Profile, and if the PoC Server supports the 'Official Government Use' QoE Profile;
- 5. SHALL send the SIP BYE request to the PoC Client according to rules and procedures of the SIP/IP Core;
- 6. SHALL generate a SIP BYE request according to rules and procedures of [RFC3261];
- 7. SHOULD include a Reason header with text *'Preemption ;cause=1 ; text="UA preemption"'*, according to [RFC 4411], if the PoC Server supports the 'Official Government Use' QoE Profile and the PoC Session is released due to the arrival of another PoC Session with 'Official Government Use' QoE Profile. The PoC Server SHOULD choose language of the reason-text in the Reason header depending on the preferred language indicated in Accept-Language header received from the PoC Client in the SIP INVITE request or SIP 200 "OK" response to the SIP INVITE request, if the language is supported;
- 8. SHALL include a Resource-Priority header according to rules and procedures of [RFC4412] that is identical to the one used to establish the PoC Session, if the PoC Session was established with an 'Official Government Use' QoE Profile, and if the PoC Server supports the 'Official Government Use' QoE Profile;and,
- 9. SHALL send the SIP BYE request to the PoC Server performing the Controlling PoC Function according to rules and procedures of the SIP/IP Core;

Upon receiving a SIP 200 "OK" response to the SIP BYE request from the PoC Client, the PoC Server SHALL interact with the User Plane as specified in [OMA-PoC-UP] *"Participating PoC Function procedures at PoC Session release"* for releasing the User Plane resources towards the PoC Client.

Upon receiving a SIP 200 "OK" response to the SIP BYE request from the PoC Server performing the Controlling PoC Function, the PoC Server SHALL interact with the User Plane as specified in [OMA-PoC-UP] *"Participating PoC Function procedures at PoC Session release"* for releasing the User Plane resources towards the PoC Server performing the Controlling PoC Function.

If the PoC Session to be released uses Pre-established Session, the PoC Server performing the Participating PoC Function:

- 1. SHALL interact with the User Plane as specified in [OMA-PoC-UP] *"Participating PoC Function procedures at PoC Session release"* for releasing the User Plane resources towards the PoC Client;
- 2. SHALL generate a SIP BYE request according to rules and procedures of [RFC3261];
- 3. SHOULD include a Reason header with text *'Preemption ;cause=1 ; text="UA preemption"'*, according to [RFC 4411], if the PoC Server supports the 'Official Government Use' QoE Profile and the PoC Session is released due to the arrival of another PoC Session with 'Official Government Use' QoE Profile. The PoC Server SHOULD choose language of the reason-text in the Reason header depending on the preferred language indicated in Accept-Language header received from the PoC Client in the SIP INVITE request or SIP 200 "OK" response to the SIP INVITE request, if the language is supported;
- 4. SHALL include a Resource-Priority header according to rules and procedures of [RFC4412] that is identical to the one used to establish the PoC Session, if the PoC Session was established with an 'Official Government Use' QoE Profile, and if the PoC Server supports the 'Official Government Use' QoE Profile;
- 5. SHALL send the SIP BYE request to the PoC Server performing the Controlling PoC Function according to rules and procedures of the SIP/IP Core;
- 6. SHALL interact with the User Plane as specified in [OMA-PoC-UP] *"Participating PoC Function procedures at PoC Session release"* for disconnecting User Plane resources towards the PoC Client; and,
- 7. SHALL maintain the Pre-established Session towards the PoC Client.

Upon receiving a SIP 200 "OK" response to the SIP BYE request from the PoC Server performing the Controlling PoC Function, the PoC Server SHALL interact with the User Plane as specified in [OMA-PoC-UP] *"Participating PoC Function procedures at PoC Session release"* for releasing the User Plane resources towards the PoC Server performing the Controlling PoC Function.

7.3.2.11 Querying for capabilities

Upon receiving a SIP OPTIONS request, the PoC Server:

- 1. SHALL handle the SIP OPTIONS request as an SIP INVITE request as specified in the subclause 7.3.2.2 "*PoC Session invitation request*" modified as follows:
 - a) any procedure checking the offered Media Types, offered the Media-floor Control Entities or the offered Media-floor Control Entity bindings are executed as if a MIME SDP body containing MBCP with bound PoC Speech was received;
 - b) the interactions with the User Plane are not performed;
 - c) the SIP OPTIONS request is sent instead of the SIP INVITE request;
 - d) the SIP OPTIONS request does not establish a PoC Session; and,
 - e) if the SIP 200 "OK" response is generated and if the PoC Server acts as B2BUA, the PoC Server additionally:
 - i. SHOULD include in the SIP response an Allow header with the supported SIP methods according to rules and procedures of [RFC3261];
 - ii. SHOULD include in the SIP response an Accept header with the supported MIME body Media Types according to rules and procedures of [RFC3261];
 - iii. SHOULD include in the SIP response an Accept-Encoding header with the supported encoding formats according to rules and procedures of [RFC3261];
 - iv. SHOULD copy into the SIP response the Accept-Language header from the received 200 "OK" SIP response according to rules and procedures of [RFC3261];
 - v. SHOULD copy into the SIP response the Supported header from the received 200 "OK" SIP response according to rules and procedures of [RFC3261];
 - vi. SHALL either
 - 1. remove the Contact header from the SIP response; or,
 - 2. replace the Contact header value in the SIP response with the Contact header value and feature tags of the received SIP response according to rules and procedures of [RFC3261]; or,
 - 3. replace a Contact header according to rules and procedures of [RFC3261] based on the Contact header of the incoming SIP response and the local policy of the PoC Server.
 - vii. SHALL either
 - 1. remove the MIME SDP body from the SIP response; or,
 - 2. replace the MIME SDP body in the SIP response with the MIME SDP body of the received SIP response to rules and procedures of [RFC3261]; or,
 - 3. replace the MIME SDP body according to rules and procedures of [RFC3261] based on the content of the MIME SDP body of the incoming SIP response, the the PoC Server's local policy.

NOTE: The MIME SDP body included in the SIP 200 "OK" response to the SIP OPTIONS request is not an SDP answer.

When the SIP/IP Core corresponds with 3GPP/3GPP2 IMS, the PoC Server SHALL use 3GPP/3GPP2 IMS Session establishment mechanisms according to rules and procedures of [3GPP TS 24.229] / [3GPP2 X.S0013.4] with the clarifications given in this subclause.

7.3.3 Requests initiated by the PoC Server performing the Participating PoC Function

7.3.3.1 Subscribing to Participant Information

The PoC Server performing the Participating PoC Function MAY subscribe to the conference state event package to obtain information of the Participants of a PoC Session, e.g. for charging purposes.

When subscribing to the conference state event package, the PoC Server:

- 1. SHALL generate a SIP SUBSCRIBE request, using a new SIP-dialog when initiating a new subscription, according to rules and procedures of [RFC3265] and [RFC4575];
- 2. SHALL set the Request-URI of the SIP SUBSCRIBE request to PoC Session Identity;
- 3. SHOULD set the 'Expires' header to a value greater than zero.
- 4. SHALL include an Accept-Contact header with the PoC feature tag '+g.poc.talkburst' along with 'require' and 'explicit' parameters according to rules and procedures of [RFC3841] in an initial SIP SUBSCRIBE request;

NOTE: When refreshing the subscription the parameters are specified here and in [RFC3265].

- 5. SHALL include a User-Agent header to indicate the OMA PoC release version of the PoC Server as specified in subclause E.4.1 "*Release version in User-agent and Server headers*";
- 6. SHALL include the PoC feature tag '+g.poc.talkburst' in the Contact header;
- 7. SHALL include an Authenticated Originator's PoC Address with the address of the PoC Server;
- 8. SHALL include a Target-Dialog header as specified in [RFC4538]; and,
- 9. SHALL send the SIP SUBSCRIBE request towards the PoC Server performing the Controlling PoC Function according to rules and procedures of the SIP/IP Core.

Upon receiving a SIP 200 "OK" or a SIP 202 "Accepted" response to the SIP SUBSCRIBE request the PoC Server:

- 1. SHALL handle the request according to rules and procedures of [RFC3261].

Upon receiving an incoming SIP NOTIFY request that is part of the same SIP dialog as the previously sent SIP SUBSCRIBE request the PoC Server:

- 1. SHALL handle the request according to rules and procedures of [RFC3265] and [RFC4575].

When needed the PoC Server SHALL terminate the subscription and indicate it terminated according to rules and procedures of [RFC3265].

The contents of the SIP NOTIFY request body is specified in subclause 7.2.1.11.2 "*Generating a SIP NOTIFY request*".

When the SIP/IP Core corresponds with 3GPP/3GPP2 IMS, the PoC Server SHALL use 3GPP/3GPP2 IMS mechanisms according to rules and procedures of [TS24.229] / [3GPP2 X.S0013.4] with the clarifications given in this subclause.

7.4 Handling of requests unrelated to PoC Sessions

7.4.1 Instant Personal Alert

7.4.1.1 Instant Personal Alert procedure at Originating PoC Server

Upon receiving a SIP MESSAGE request containing the PoC feature tag '+g.poc.talkburst' in the Accept-Contact header, the PoC Server:

- 1. SHALL return a SIP 403 "Forbidden" response with the warning text set to '119 Anonymity not allowed' as specified in subclause 5.6 "*Warning header*", if anonymity is requested. Otherwise, continue with the rest of the steps;
- 2. SHALL perform actions to verify the Authenticated Originator's PoC Address of the PoC User and authorize the request according to local policy, and if not authorized the PoC Server SHALL respond with a SIP 403 "Forbidden"

response with the warning text set to '121 Function not allowed due to <detailed reason>' as specified in subclause 5.6 "Warning header" to the PoC Client. Otherwise, continue with the rest of the steps; and,

- 3. SHALL forward the SIP MESSAGE request to the SIP/IP Core.

Upon receiving a SIP final response PoC Server SHALL forward the SIP final response along the signalling path towards the originating PoC Client according to rules and procedures of [RFC3261].

When the SIP/IP Core corresponds with 3GPP/3GPP2 IMS, the PoC Client SHALL use 3GPP/3GPP2 IMS mechanisms, according to rules and procedures of [3GPP TS 24.229] / [3GPP2 X.S0013.4] with the clarifications given in this subclause.

7.4.1.2 Instant Personal Alert procedure at terminating PoC Server

Upon receiving a SIP MESSAGE request containing the PoC feature tag '+g.poc.talkburst' in the Accept-Contact header and the request includes a PoC Address in the Request-URI that is served by the PoC Server then, the PoC Server:

- SHALL check the receiving PoC User's PoC Service Settings associated to the PoC Address received in the Request-URI. If the PoC Service Settings have not been received from the PoC Client yet or if PoC Service Settings expiration timer has expired, the PoC Server SHALL respond with a SIP 480 "Temporarily Unavailable" response. Otherwise continue with the rest of the steps;
- 1. SHALL check if the Authenticated Originator's PoC Address in the initial SIP MESSAGE request is not 'true' in the <allow-reject-invite> action associated to the Invited PoC User indicated by the Request-URI as described in [OMA-PoC-Document-Mgmt]. If it is 'true', the PoC Server SHALL respond with a SIP 403 "Forbidden" response with the warning text set to '121 Function not allowed due to <detailed reason>' as specified in subclause 5.6 "Warning header" to the originating network. Otherwise, continue with the rest of the steps;
- 2. SHALL check the terminating PoC User's Incoming Instant Personal Alert Barring setting associated to the PoC Address received in the Request-URI. If the Incoming Instant Personal Alert Barring is activated the PoC Server performing the Participating PoC Function SHALL respond with a SIP 480 "Temporarily Unavailable" response to the originating network. The response is sent along the signalling path. Otherwise, continue with the rest of the steps; and,
- 3. SHALL forward the SIP MESSAGE request towards the PoC Client of the terminating PoC User according to rules and procedures of the SIP/IP Core.

Upon receiving a SIP final response PoC Server SHALL forward the SIP final response along the signalling path towards the originating PoC Client according to rules and procedures of [RFC3261].

When the SIP/IP Core corresponds with 3GPP/3GPP2 IMS, the PoC Server SHALL use 3GPP/3GPP2 IMS mechanisms, according to rules and procedures of [3GPP TS 24.229] / [3GPP2 X.S0013.4] with the clarifications given in this subclause.

7.4.2 Subscribing to the SIP Registration event

In order for the PoC Server performing the Participating PoC Function to associate PoC Sessions to a PoC Client or associate PoC Sessions to a UE PoC Box the PoC Server need to cache the relation between PoC Addresses and the registered PoC Client and between PoC Addresses and the registered UE PoC Box.

The SIP/IP Core sends all SIP REGISTER requests where at least one of the contacts in the SIP REGISTER request includes the feature tag "+g.poc.talkbursts" or "+g.poc.groupad" or both.

7.4.2.1 Reception of the SIP REGISTER request

Upon receiving a SIP REGISTER request the PoC Server:

- 1. SHALL generate a SIP 200 "OK" response according to rules and procedures of [RFC3261]; and,
- 2. SHALL send the SIP 200 "OK" response according to rules and procedures of SIP/IP Core.

If the PoC Server does not already subscribe to the "reg" event package for the PoC Address received in the SIP REGISTER request the PoC Server:

- 1. SHALL generate a SIP SUBSCRIBE request according to rules and procedures of [RFC3265] and [RFC3680];
- 2. SHALL set the Request-URI of the SIP SUBSCRIBE request to the PoC Address received in the SIP REGISTER request;

- 3. SHALL set the Authenticated Originator's PoC Address to a SIP URI of the PoC Server;
- 4. MAY set a expiration timer in Expires header, if set, the value of the timer SHALL be set according to rules and procedures of [RFC3903], in the same range as the registration timer recommended by SIP/IP Core; and,
- 5. SHALL send the SIP SUBSCRIBE request towards the PoC Server using a new SIP dialog, according to rules and procedures of the SIP/IP Core.

When the SIP/IP Core corresponds with 3GPP/3GPP2 IMS, the PoC Server SHALL use 3GPP/3GPP2 IMS mechanisms, according to rules and procedures of [3GPP TS 24.229] / [3GPP2 X.S0013.4] with the clarifications given in this subclause.

7.4.2.2 Reception of the SIP NOTIFY request

Upon receiving a SIP NOTIFY request from SIP/IP Core as the result of the "reg" event subscription the PoC Server:

- 1. SHALL generate a SIP 200 "OK" response according to rules and procedures of [RFC3265] and [RFC3680];
- 2. SHALL send the SIP 200 "OK" response according to rules and procedures of SIP/IP Core;
- 3. SHALL handle the received registration information as specified in subclause 5.7A "*PoC Session association*"; and,
- 4. SHALL terminate the subscription as specified in [RFC3265] and [RFC3680] if there is no cached registration information any longer for this PoC User.

When the SIP/IP Core corresponds with 3GPP/3GPP2 IMS, the PoC Server SHALL use 3GPP/3GPP2 IMS mechanisms, according to rules and procedures of [3GPP TS 24.229] / [3GPP2 X.S0013.4] with the clarifications given in this subclause.

7.5 Error Handling

7.5.1 Conference-factory URI does not exist

Upon receiving a request that includes as the Request-URI a Conference-factory-URI that is not allocated in the PoC Server, the PoC Server SHALL return a SIP 404 "Not found" response.

7.5.2 Conference URI does not exist

Upon receiving a SIP INVITE request that includes as the Request-URI a Conference URI that is not allocated in the PoC Server performing the Controlling PoC Function, the PoC Server SHALL return a SIP 404 "Not found" response.

8. PoC Box

This subclause describes the action in the NW PoC Box and the UE PoC Box.

8.1 Common PoC Box procedures

8.1.1 General

NOTE 1: This subclause provides common procedures for other subclauses and is not meant to be applied unless referenced.

Upon receiving an initial SIP INVITE request the PoC Box:

- 1. SHALL validate that at least one Media Stream and Media Parameters and at least one codec or Media format offered in the SIP INVITE request are acceptable to the PoC Box and if not, reject the request with a SIP 488 "Not Acceptable Here" response. Otherwise, continue with the rest of the steps;
- 2. MAY reject the SIP INVITE request with an appropriate reject code as specified in [RFC3261] e.g.
 - a) when the PoC Box determines that there is not enough resources to handle the PoC Session; or,
 - b) any other reason outside the scope of this specification.
- 3. SHALL cache the list of supported SIP methods if received in the Allow header;
- 4. SHALL cache as the PoC Session Identity the content of the Contact header;
- 5. SHALL store the PoC Address of the Inviting PoC User obtained from the Authenticated Originator's PoC Address in case of 1-1 PoC Session and Ad-hoc PoC Group Session or from the Referred-By header in case of Pre-arranged PoC Group Session;
- 6. SHALL store the PoC Group Identity obtained from the Authenticated Originator's PoC Address in case of Pre-arranged PoC Group Session;
- 7. SHALL store the Session Type information based on the information received in the Session-Type uri-parameter in the Contact header;
- 8. SHALL discard the MIME bodies containing Included Media Content if included in the SIP INVITE request;
- 9. MAY store the Subject header if Included Text Content is supported and if the Subject header is included in the SIP INVITE request; and,
- 10. SHALL discard references in the Alert-Info header or in the Call-Info header or both, if the Alert-Info header and the Call-Info header are included in the SIP INVITE request.

When generating SIP responses other than the SIP 100 "Trying" to the received initial SIP request the PoC Box:

- 1. SHALL generate SIP responses according to rules and procedures of [RFC3261];

NOTE 2: The use of the option tag 'precondition', as specified in [RFC3312], and the option tag '100rel', as specified in [RFC3262], is not defined for the PoC-11 reference point.

- 2. SHALL include the option tag 'timer' in a Require header;
- 3. SHOULD include an Allow header with the SIP methods supported in this SIP dialog according to rules and procedures of [RFC3261];
- 4. SHALL include the Session-Expires header and start the SIP Session timer according to rules and procedures specified in [RFC4028], "*UAS Behavior*". The 'refresher' parameter in the Session-Expires header SHALL be set to 'uas';
- 5. SHALL include the PoC Address of the PoC User as the Authenticated Originator's PoC Address as specified in subclause 5.2 "*Authenticated Originator's PoC Address*";
- 6. SHALL include the PoC feature tag '+g.poc.talkburst' in the Contact header;
- 7. SHALL include the PoC feature tag '+g.poc.discretedia' in the Contact header, if the PoC Box supports Discrete Media and is configured to accept Discrete Media;

NOTE 3: Configuration of PoC Box is out of scope of this specification.

- 8. SHALL include a the warning text set to '108 Media in INVITE discarded' as specified in subclause 5.6 "*Warning header*", if at least one MIME body with media was removed or if the Subject header was removed or if the Alert-Info header was removed or if the Call-Info header was removed as specified in this subclause.

When the SIP/IP Core corresponds with 3GPP/3GPP2 IMS, the PoC Box SHALL use 3GPP/3GPP2 IMS mechanisms according to rules and procedures of [3GPP TS24.229] / [3GPP2 X.S0013.4] with the clarifications given in this subclause.

8.1.2 PoC Box SDP answer generation

When composing an SDP answer according to rules and procedures of [RFC3264] and [RFC4566] the PoC Box:

- 1. SHALL set the IP address of the PoC Box for each accepted Media Stream from the received SDP offer and for each accepted Media-floor Control Entity from the received SDP offer;
- 2. SHALL include the media-level section for each accepted Media Stream from the received SDP offer consisting of:
 - a) the port number for the Media Stream selected as specified in [OMA-PoC-UP] "*Port numbers*";
 - b) the codec(s) and Media Parameters acceptable by the PoC Box for the PoC Service selected from those in the SDP offer contained in the incoming SIP INVITE request;

NOTE: The Media Parameters of the Discrete Media are defined in [OMA_IM_TS_Endorsement].

- 3. SHALL include for any Media-floor Control Entity, that is offered in the SDP offer and accepted in the SDP answer, the media-level section of each offered Media-floor Control Entity consisting of:
 - c) the "a=label" attribute with a unique value as specified in [RFC4574], if the Media Stream is to be connected to a Media-floor Control Entity and except when only PoC Speech with TBCP is accepted; and,
 - d) the IP address of the PoC Box and port number to be used for RTCP selected as specified in [OMA-PoC-UP] "*Port numbers*", according to rules and procedures of [RFC3605], if the Media Stream uses the RTCP protocol and other than the default IP address or port number specified by the [RFC3550] is to be used.
- 3. SHALL include for any Media-floor Control Entity, that is offered in the SDP offer and accepted in the SDP answer, the media-level section of each offered Media-floor Control Entity consisting of:
 - a) the format list field for the Media-floor Control Entity is set to "TBCP";
 - b) the Media-floor Control Entity parameters selected from those in the SDP offer contained in the SIP INVITE request, including if needed, the TBCP MIME parameter "multimedia" with the appropriated value as specified in E.3 "*SDP Extensions*";
 - c) the port number for Media-floor Control Entity as specified in [OMA-POC-UP] "*Port numbers*"; and,
 - d) the "a=floorid:0 mstrm" attribute with value(s) referencing the Media Stream as specified in [RFC4583] intended to be connected the Media-floor Control Entity except when only PoC Speech with Talk Burst Control Protocol as specified in [OMA-POC-1-UP] is accepted;
- 4. SHALL mark as rejected according to rules and procedures of [RFC3264] the Media-floor Control Entity and all the Media Stream bound to the rejected Media-floor Control Entity, if the Media-floor Control Entity is either rejected or not supported;
- 5. SHALL mark the Media Stream as rejected according to rules and procedures of [RFC3264], if Media Stream is rejected or not supported.

When composing an SDP answer, the PoC Box:

- 1. SHALL bind the media-level section that identifies PoC Speech to the corresponding Media-floor Control Entity as in the SDP offer, if PoC Speech is accepted;
- 2. SHALL bind the media-level section that identifies Video to the corresponding Media-floor Control Entity as in the SDP offer, if Video is accepted;
- 3. SHALL bind the media-level section that identifies Audio to the corresponding Media-floor Control Entity as in the SDP offer, if Audio is accepted; and
- 4. SHALL bind the media-level section that identifies Discrete Media to corresponding Media-floor Control Entity as in the SDP offer, if Discrete Media is accepted and bound to a Media-floor Control Entity.

When the SIP/IP Core corresponds with 3GPP/3GPP2 IMS, the PoC Box SHALL use 3GPP/3GPP2 IMS mechanisms according to rules and procedures of [3GPP TS24.229] / [3GPP2 X.S0013.4] with the clarifications given in this subclause.

8.1.3 PoC Box receiving a request for User plane adaptation

When validating the SIP UPDATE request or the SIP re-INVITE request the PoC Box:

- 1. SHALL validate that the Media Parameters and at least one codec or Media Format are acceptable to the PoC Box, and if not, send a SIP 488 "Not Acceptable Here" response and do not continue with the rest of the steps.

When sending the SIP 200 OK response to the SIP UPDATE request or to the SIP re-INVITE request the PoC Box:

- 1. SHALL generate a SIP 200 "OK" according to rules and procedures of [RFC3261];
- 2. SHALL include the Session-Expires header in the SIP 200 "OK" response to the SIP UPDATE or SIP re-INVITE request and re-start the SIP Session timer according to rules and procedures specified in [RFC4028], "UAS Behavior". The "refresher" parameter in the Session-Expires header SHALL be set to 'uas';
- 3. SHALL include the option tag 'timer' in the Require header;
- 4. SHALL include the accepted Media Parameters in a MIME SDP body as the SDP answer to the SDP offer in the SIP UPDATE or SIP re-INVITE request as specified in the subclause 8.1.2 "PoC Box SDP answer generation".

When the SIP/IP Core corresponds with 3GPP/3GPP2 IMS, the PoC Box SHALL use 3GPP/3GPP2 IMS mechanisms according to rules and procedures of [3GPP TS 24.229] / [3GPP2 X.S0013.4] with the clarifications given in this subclause.

8.1.4 PoC Box receiving a request to add and disconnect Media Streams

When validating the received SDP offer in a SIP UPDATE request or a SIP re-INVITE request the PoC Box:

- 1. SHALL validate that the offered Media Streams are supported by the PoC Box, and mark the not supported Media Streams as rejected in the SDP offer according to rules and procedures of [RFC3264];
- 2. SHALL, for each offered Media Stream not yet rejected, validate that at least one offered codec or Media format is supported by the PoC Box, and if not, reject the particular Media Stream in the SDP offer according to rules and procedures of [RFC3264];
- 3. SHALL, for each offered Media Stream not yet rejected, validate that the Media Parameters are acceptable for the PoC Box and if not, reject the particular Media Stream in the SDP offer according to rules and procedures of [RFC3264];
- 4. SHALL reject the request with a SIP 488 "Not Acceptable Here" response towards the PoC Server according to rules and procedures of SIP/IP Core, if all offered Media Streams are rejected and do not continue with the rest of the steps;
- 5. SHALL, for the offered Media Stream, which were not yet rejected and which are not used currently or if the current Media-floor Control Entity binding of a Media used by the PoC Box and offered to the PoC Box is not the same as in the received SDP offer the PoC Box, either
 - a) reject the Media Streams in the SDP offer according to rules and procedure of [RFC3264]; or,
 - b) accept the Media Streams;

When sending a SIP 200 "OK" response to the SIP UPDATE request or to the SIP re-INVITE request the PoC Box:

- 1. SHALL generate SIP 200 "OK" response according to rules and procedures of [RFC3261]; and,
- 2. SHALL include in the SIP 200 "OK" response an SDP answer to the SDP offer as specified in subclause 8.1.2 "PoC Box SDP answer generation".

When the SIP/IP Core corresponds to 3GPP/3GPP2 IMS, the UE PoC Box SHALL use 3GPP/3GPP2 IMS mechanisms according to rules and procedures of [3GPP TS 24.229] / [3GPP2 X.S0013.4] with the clarifications given in this subclause.

8.2 NW PoC Box specific procedures

8.2.1 NW PoC Box invited to PoC Session

Upon receiving a SIP INVITE request the NW PoC Box:

- 1. SHALL reject the request with a SIP 480 "Temporarily Unavailable" response, if the MIME message/sipfrag body containing the User-Agent header indicating the Inviting PoC Client compliant only to the OMA PoC version 1.0 specification as specified in subclause E.4.1 "*Release version in User-agent and Server headers*" is included in the received SIP INVITE request and the NW PoC Box does not support PoC Sessions initiated by Inviting PoC Client compliant only to OMA PoC version 1.0 specification. Otherwise continue with the rest of the steps;
- 2. SHALL check by using the identity in the Request-URI if the PoC User has a PoC Box subscription if not the NW PoC Box SHALL return a SIP 403 "Forbidden" response with the warning text set to '121 Function not allowed due to <detailed reason>' as specified in subclause 5.6 "*Warning header*". Otherwise, continue with the rest of the steps;
- 3. SHALL check whether there is a Reject-Contact header containing the feature tag 'sip.automata' and the feature tag 'sip.actor' set to 'msg-taker', and if it is then the NW PoC Box SHALL return a SIP 403 "Forbidden" response with the warning text set to '121 Function not allowed due to <detailed reason>' as specified in subclause 5.6 "*Warning header*". Otherwise continue with the rest of the steps;
- 4. SHALL check whether the Session Type uri parameter is "session=1-1" or if the SIP INVITE request includes a Accept-Contact header with the feature tag "sip.automata" and the feature tag 'sip.actor' set to 'msg-taker' along with the parameters 'explicit' and 'required', if it is not then the NW PoC Box SHALL return a SIP 403 "Forbidden" response with the warning text set to '121 Function not allowed due to <detailed reason>' as specified in subclause 5.6 "*Warning header*". Otherwise continue with the rest of the steps;
- 5. SHALL perform the procedures for receiving an initial SIP INVITE request as specified in 8.1.1 "*General*";
- 6. SHALL accept the request and generate a SIP 200 "OK" response as specified in the subclause 8.1.1 "*General*" towards the PoC Server;
- 7. SHALL include Server header to indicate the OMA PoC release version of the NW PoC Box as specified in subclause E.4.1 "*Release version in User-agent and Server headers*";
- 8. SHALL include in the SIP 200 "OK" response the feature tag 'sip.automata' and the feature tag 'sip.actor' with the value of 'msg-taker' in the Contact header along with the Contact Address of the NW PoC Box;

NOTE 1: The NW PoC Box sends the Media informing the Inviting PoC User about recording, if the MIME message/sipfrag body containing the User-Agent header indicating the Inviting PoC Client compliant only to OMA PoC version 1.0 specification as specified in subclause E.4.1 "*Release version in User-agent and Server headers*" was included in the received SIP INVITE request.

- 9. SHALL include in the SIP 200 "OK" response a MIME SDP body as an SDP answer to the SDP offer in the incoming SIP INVITE request as specified in the subclause 8.1.2 "*PoC Box SDP answer generation*";
- 10. SHALL interact with the User Plane as specified in [OMA-PoC-UP] "*NW PoC Box procedures at PoC Session initialization*"; and,

NOTE 2: Resulting User Plane processing is completed before the next step is performed.

- 11. SHALL send the SIP 200 "OK" response towards the PoC Server according to rules and procedures of the SIP/IP Core.

When the SIP/IP Core corresponds with 3GPP/3GPP2 IMS, the NW PoC Box SHALL use 3GPP/3GPP2 IMS Session establishment mechanisms according to rules and procedures of [3GPP TS 24.229] / [3GPP2 X.S0013.4] with the clarifications given in this subclause.

8.2.2 NW PoC Box PoC Session release request

Upon receiving a SIP BYE request, the NW PoC Box:

- 1. SHALL send SIP 200 "OK" response towards PoC Server according to rules and procedures of the SIP/IP Core; and,
- 2. SHALL interact with the User Plane as specified in [OMA-PoC-UP] "*NW PoC Box procedures at PoC Session release*".

When the SIP/IP Core corresponds with 3GPP/3GPP2 IMS, the NW PoC Box SHALL use 3GPP/3GPP2 IMS mechanisms according to rules and procedures of [3GPP TS 24.229] / [3GPP2 X.S0013.4] with the clarifications given in this subclause.

8.2.3 NW PoC Box leaving a PoC Session - On-demand Session case

When the NW PoC Box wants to leave the PoC Session that has been established the NW PoC Box:

- 1. SHALL interact with the User Plane as specified in [OMA-PoC-UP] "*NW PoC Box procedures at PoC Session release*";
- 2. SHALL generate a SIP BYE request according to rules and procedures of [RFC3261];
- 3. SHALL set the Request-URI to the PoC Session Identity of the PoC Session to leave; and,
- 4. SHALL send a SIP BYE request towards PoC Server according to rules and procedures of SIP/IP Core.

Upon receiving a SIP 200 "OK" response to the SIP BYE request, the NW PoC Box SHALL interact with the User Plane as specified in [OMA-PoC-UP] "*NW PoC Box procedures at PoC Session release*".

When the SIP/IP Core corresponds with 3GPP/3GPP2 IMS, the PoC Box SHALL use 3GPP/3GPP2 IMS Session establishment mechanisms according to rules and procedures of [3GPP TS 24.229] / [3GPP2 X.S0013.4] with the clarifications given in this subclause.

8.2.4 NW PoC Box receiving capability query

NOTE 1: Only the terminating side capability query procedures are described since any entity can send the SIP OPTIONS request

Upon receiving a SIP OPTIONS request, the NW PoC Box:

- 1. SHALL handle the SIP OPTIONS request as an SIP INVITE request as specified in the subclause 8.2.1 "*NW PoC Box invited to PoC Session*" modified as follows:
 - a) any procedure checking the offered Media Types, offered the Media-floor Control Entities or the offered Media-floor Control Entity bindings are executed as if a MIME SDP body containing MBCP with bound PoC Speech was received;
 - b) the interactions with the User Plane are not performed; and,
 - c) if generating the SIP 200 "OK" response the NW PoC Box additionally:
 - i. SHOULD include in the SIP response an Allow header with the supported SIP methods according to rules and procedures of [RFC3261];
 - ii. SHOULD include in the SIP response an Accept header with the supported MIME body Media Types according to rules and procedures of [RFC3261];
 - iii. SHOULD include in the SIP response an Accept-Encoding header with the supported encoding formats according to rules and procedures of [RFC3261];
 - iv. SHOULD include in the SIP response a Supported header with an option tag 'timer' according to rules and procedures of [RFC3261];
 - v. SHALL either remove the Contact header from the SIP response or SHALL replace the Contact header value in the SIP response with the PoC Address of the PoC User according to rules and procedures of [RFC3261]; and,
 - vi. SHALL either remove the MIME SDP body from the SIP response or SHALL replace the MIME SDP body in the SIP response with a MIME SDP body containing the Media Types, the Media-floor Control Entities and the Media-floor Control Entity bindings supported by the NW PoC Box according to rules and procedures of [RFC3261].

NOTE 2: The MIME SDP body included in the SIP 200 "OK" response to the SIP OPTIONS request is not an SDP answer.

When the SIP/IP Core corresponds with 3GPP/3GPP2 IMS, the NW PoC Box SHALL use 3GPP/3GPP2 IMS Session establishment mechanisms according to rules and procedures of [3GPP TS 24.229] / [3GPP2 X.S0013.4] with the clarifications given in this subclause.

8.2.5 NW PoC Box receiving a request for User plane adaptation

Upon receiving a SIP UPDATE request, or a SIP re-INVITE request with a MIME SDP body including a new SDP offer as specified by [RFC3264] and [RFC4566], the NW PoC Box:

- 1. SHALL perform actions to validate the received SDP answer as specified in 8.1.3 "*PoC Box receiving a request User Plane adaptation*" and if not successful, do not continue with the rest of the steps;
- 2. SHALL generate a SIP 200 "OK" response to the SIP UPDATE request or to the SIP re-INVITE request as specified in 8.1.3 "*PoC Box receiving a request for User plane adaptation*";
- 3. SHALL interact with User Plane
 - a) as specified in [OMA-PoC-UP] "*NW PoC Box procedures at PoC Session modification*", if the SDP answer contains changes in the Media Parameters, Media formats or codecs compared to the previously agreed SDP and if the PoC Box is the NW PoC Box; or,
 - b) as specified in [OMA-PoC-UP] "*NW PoC Box procedures at PoC Session modification*", if the SDP answer contains a Media Stream, that is currently used by the NW PoC Box, marked as rejected or if the current Media-floor Control Entity binding of a Media used by the NW PoC Box and offered to the NW PoC Box is not the same as in the received SDP offer; or,
 - c) as specified in [OMA-PoC-UP] "*NW PoC Box procedures at PoC Session modification*", if the SDP answer contains an accepted Media which is not currently used by the NW PoC Box in the PoC Session or if the current Media-floor Control Entity binding of a Media used by the NW PoC Box and offered to the NW PoC Box is not the same as in the received SDP offer;
- 4. SHALL send the SIP 200 "OK" response towards the PoC Server according to rules and procedures of SIP/IP Core.

When the SIP/IP Core corresponds to 3GPP/3GPP2 IMS, the NW PoC Box SHALL use 3GPP/3GPP2 IMS mechanisms according to rules and procedures of [3GPP TS 24.229] / [3GPP2 X.S0013.4] with the clarifications given in this subclause.

8.2.6 NW PoC Box receiving a request to add and disconnect Media Streams

When the NW PoC Box receives a request to add a new Media Stream to the existing PoC Session, to remove the currently used Media Stream from the PoC Session, to change the Media-floor Control Entity binding of a used Media in the PoC Session or a combination of these, the NW PoC Box:

- 1. SHALL perform actions to validate the received SDP answer as specified in 8.1.4 "*PoC Box receiving a request to add and disconnect Media Streams*" and if not successful do not continue with the rest of the steps;
- 2. SHALL interact with User Plane as specified in [OMA-PoC-UP] "*NW PoC Box procedures at PoC Session modification*", if the SDP answer contains changes in the Media Parameters, Media formats or codecs compared to the previously agreed SDP;
- 3. SHALL interact with User Plane
 - a) as specified in [OMA-PoC-UP] "*NW PoC Box procedures at PoC Session modification*", if the SDP answer contains a Media Stream, that is currently used by the NW PoC Box, marked as rejected or if the current Media-floor Control Entity binding of a Media used by the NW PoC Box and offered to the NW PoC Box is not the same as in the received SDP offer; or,
 - b) as specified in [OMA-PoC-UP] "*NW PoC Box procedures at PoC Session modification*", if the SDP answer contains an accepted Media which is not currently used by the NW PoC Box in the PoC Session or if the current Media-floor Control Entity binding of a Media used by the NW PoC Box and offered to the NW PoC Box is not the same as in the received SDP offer; or,
- 4. SHALL generate a SIP 200 "OK" response as specified in subclause 8.1.4 "*PoC Box receiving a request to add and disconnect Media Streams*"; and,
- 5. SHALL send the SIP 200 "OK" response towards the PoC Server according to rules and procedures of SIP/IP Core.

When the SIP/IP Core corresponds to 3GPP/3GPP2 IMS, the NW PoC Box SHALL use 3GPP/3GPP2 IMS mechanisms according to rules and procedures of [3GPP TS 24.229] / [3GPP2 X.S0013.4] with the clarifications given in this subclause.

8.2.7 NW PoC Box receiving a Discrete Media in a SIP MESSAGE request

If the NW PoC Box supports receiving and storing Discrete Media and receives a SIP MESSAGE request in the SIP dialog used for the recorded PoC Session, the NW PoC Box:

- 1. SHALL perform the actions specified in [OMA_IM_TS_Endorsement] "*PoC Client receives SIP MESSAGE*";
- 2. SHALL generate SIP 200 "OK" response as described in [OMA_IM_TS_Endorsement] "*PoC Client receives SIP MESSAGE*".
- 3. SHOULD store the received content of the SIP MESSAGE request; and,
- 4. SHALL store the PoC Address or Nick Name or both retrieved from the message/cpim From header in the SIP MESSAGE request body, if the corresponding Media is stored.

When the SIP/IP Core corresponds with 3GPP/3GPP2 IMS, the NW PoC Box SHALL use 3GPP/3GPP2 IMS Session establishment mechanisms according to rules and procedures of [3GPP TS 24.229] / [3GPP2 X.S0013.4] with the clarifications given in this subclause.

8.3 UE PoC Box specific procedures

8.3.1 UE PoC Box invited to a PoC Session

Upon receiving a SIP INVITE request the UE PoC Box:

- 1. SHALL check whether there is a Reject-Contact header containing the feature tag 'sip.automata' and the feature tag 'sip.actor' set to 'principal' and the feature tag 'sip.description' with the value "poc recording device", and if it is then the UE PoC Box SHALL return a SIP 403 "Forbidden" response with the warning text set to '121 Function not allowed due to <detailed reason>' as specified in subclause 5.6 "*Warning header*". Otherwise continue with the rest of the steps;
- 2. SHALL check whether the Session Type uri parameter is "session=1-1" or if the SIP INVITE request includes an Accept-Contact header with the feature tag "sip.automata" and the feature tag 'sip.actor' set to 'principal' and the feature tag 'sip.description' with the value "poc recording device" along with the parameters 'explicit' and 'required', if it is not then the UE PoC Box SHALL return a SIP 403 "Forbidden" response with the warning text set to '121 Function not allowed due to <detailed reason>' as specified in subclause 5.6 "*Warning header*". Otherwise continue with the rest of the steps;
- 3. SHALL perform the procedures for receiving an initial SIP INVITE request as specified in 8.1.1 "*General*";
- 4. SHALL accept the request and generate a SIP 200 "OK" response using the procedures specified for the PoC Client as specified in the subclause 8.1.1 "*General*" towards the PoC Server;
- 5. SHALL include Server header to indicate the OMA PoC release version of the UE PoC Box as specified in subclause E.4.1 "*Release version in User-agent and Server headers*";
- 6. SHALL include in the SIP 200 "OK" response the feature tag 'sip.automata' and the feature tag 'sip.actor' with the value 'principal' and the feature tag 'sip.description' with the value "poc recording device" in the Contact header along with the contact address of the UE PoC Box;
- 7. SHALL include in the SIP 200 "OK" response a MIME SDP body as an SDP answer to the SDP offer in the incoming SIP INVITE request as specified in the subclause 8.1.2 "*PoC Box SDP answer generation*";
- 8. SHALL interact with the User Plane as specified in [OMA-PoC-UP] "*UE PoC Box procedures at PoC Session initialization*"; and,

NOTE: Resulting User Plane processing is completed before the next step is performed.

- 9. SHALL send the SIP 200 "OK" response towards the PoC Server according to rules and procedures of the SIP/IP Core;

When the SIP/IP Core corresponds with 3GPP/3GPP2 IMS, the UE PoC Box SHALL use 3GPP/3GPP2 IMS Session establishment mechanisms according to rules and procedures of [3GPP TS 24.229] / [3GPP2 X.S0013.4] with the clarifications given in this subclause.

8.3.2 UE PoC Box PoC Session release request

Upon receiving a SIP BYE request, the UE PoC Box:

- 1. SHALL interact with the User Plane as specified in [OMA-PoC-UP] "*UE PoC Box procedures at PoC Session release*"; and,
- 2. SHALL send SIP 200 "OK" response towards PoC Server according to rules and procedures of the SIP/IP Core.

When the SIP/IP Core corresponds with 3GPP/3GPP2 IMS, the UE PoC Box SHALL use 3GPP/3GPP2 IMS mechanisms according to rules and procedures of [3GPP TS 24.229] / [3GPP2 X.S0013.4] with the clarifications given in this subclause.

8.3.3 UE PoC Box Leaving a PoC Session - On-demand Session case

When the PoC Box needs to leave the PoC Session that has been established the PoC Box:

- 1. SHALL interact with the User Plane as specified in [OMA-PoC-UP] "*UE PoC Box procedures at PoC Session release*";
- 2. SHALL generate a SIP BYE request according to rules and procedures of [RFC3261];
- 3. SHALL set the Request-URI to the PoC Session Identity of the PoC Session to leave; and,
- 4. SHALL send a SIP BYE request towards PoC Server according to rules and procedures of SIP/IP Core.

Upon receiving a SIP 200 "OK" response to the SIP BYE request, the UE PoC Box SHALL interact with the User Plane as specified in [OMA-PoC-UP] "*UE PoC Box procedures at PoC Session release*";

When the SIP/IP Core corresponds with 3GPP/3GPP2 IMS, the UE PoC Box SHALL use 3GPP/3GPP2 IMS Session establishment mechanisms according to rules and procedures of [3GPP TS 24.229] / [3GPP2 X.S0013.4] with the clarifications given in this subclause.

8.3.4 UE PoC Box receiving capability query

NOTE 1: Only the terminating side capability query procedures are described since any entity can send the SIP OPTIONS request

Upon receiving a SIP OPTIONS request, the UE PoC Box:

- 1. SHALL handle the SIP OPTIONS request as an SIP INVITE request as specified in the subclause 8.2.1 "*NW PoC Box invited to PoC Session*" modified as follows:
 - a) any procedure checking the offered Media Types, offered the Media-floor Control Entities or the offered Media-floor Control Entity bindings are executed as if a MIME SDP body containing MBCP with bound PoC Speech was received;
 - b) the interactions with the User Plane are not performed; and,
 - c) if generating the SIP 200 "OK" response, the UE PoC Box additionally:
 - i. SHOULD include in the SIP response an Allow header with the supported SIP methods according to rules and procedures of [RFC3261];
 - ii. SHOULD include in the SIP response an Accept header with the supported MIME body Media Types according to rules and procedures of [RFC3261];
 - iii. SHOULD include in the SIP response an Accept-Encoding header with the supported encoding formats according to rules and procedures of [RFC3261];
 - iv. SHOULD include in the SIP response a Supported header with an option tag 'timer' according to rules and procedures of [RFC3261];

v. SHALL either remove the Contact header from the SIP response or SHALL replace the Contact header value in the SIP response with the PoC Address of the PoC User according to rules and procedures of [RFC3261]; and,

vi. SHALL either remove the MIME SDP body from the SIP response or SHALL replace the MIME SDP body in the SIP response with a MIME SDP body containing the Media Types, the Media-floor Control Entities and the Media-floor Control Entity bindings supported by the UE PoC Box according to rules and procedures of [RFC3261].

NOTE 2: The MIME SDP body included in the SIP 200 "OK" response to the SIP OPTIONS request is not an SDP answer.

When the SIP/IP Core corresponds with 3GPP/3GPP2 IMS, the UE PoC Box SHALL use 3GPP/3GPP2 IMS Session establishment mechanisms according to rules and procedures of [3GPP TS 24.229] / [3GPP2 X.S0013.4] with the clarifications given in this subclause.

8.3.5 UE PoC Box receiving a request for User plane adaptation

Upon receiving a SIP UPDATE request, or a SIP re-INVITE request with a MIME SDP body including a new SDP offer as specified by [RFC3264] and [RFC4566], the UE PoC Box:

- 1. SHALL perform actions to validate the received SDP answer as specified in 8.1.3 "*PoC Box receiving a request User Plane adaptation*" and if not successful, do not continue with the rest of the steps;
- 2. SHALL generate a SIP 200 "OK" response to the SIP UPDATE request or to the SIP re-INVITE request as specified in 8.1.3 "*PoC Box receiving a request for User plane adaptation*";
- 3. SHALL interact with User Plane
 - a) as specified in [OMA-PoC-UP] "*UE PoC Box procedures at PoC Session modification*", if the SDP answer contains changes in the Media Parameters, Media formats or codecs compared to the previously agreed SDP and if the PoC Box is the UE PoC Box; or,
 - b) as specified in [OMA-PoC-UP] "*UE PoC Box procedures at PoC Session modification*", if the SDP answer contains a Media Stream, that is currently used by the UE PoC Box, marked as rejected or if the current Media-floor Control Entity binding of a Media used by the UE PoC Box and offered to the UE PoC Box is not the same as in the received SDP offer; or,
 - c) as specified in [OMA-PoC-UP] "*UE PoC Box procedures at PoC Session modification*", if the SDP answer contains an accepted Media which is not currently used by the UE PoC Box in the PoC Session or if the current Media-floor Control Entity binding of a Media used by the UE PoC Box and offered to the UE PoC Box is not the same as in the received SDP offer;
- 4. SHALL send the SIP 200 "OK" response towards the PoC Server according to rules and procedures of SIP/IP Core.

When the SIP/IP Core corresponds to 3GPP/3GPP2 IMS, the UE PoC Box SHALL use 3GPP/3GPP2 IMS mechanisms according to rules and procedures of [3GPP TS 24.229] / [3GPP2 X.S0013.4] with the clarifications given in this subclause.

8.3.6 UE PoC Box receiving a request to add and disconnect Media Streams

When the UE PoC Box receives a request to add a new Media Stream to the existing PoC Session, to remove the currently used Media Stream from the PoC Session, to change the Media-floor Control Entity binding of a used Media in the PoC Session or a combination of these, the UE PoC Box:

- 1. SHALL perform actions to validate the received SDP answer as specified in 8.1.4 "*PoC Box receiving a request to add and disconnect Media Streams*" and if not successful do not continue with the rest of the steps;
- 2. SHALL interact with User Plane as specified in [OMA-PoC-UP] "*UE PoC Box procedures at PoC Session modification*", if the SDP answer contains changes in the Media Parameters, Media formats or codecs compared to the previously agreed SDP;
- 3. SHALL interact with User Plane

- a) as specified in [OMA-PoC-UP] "*UE PoC Box procedures at PoC Session modification*", if the SDP answer contains a Media Stream, that is currently used by the UE PoC Box, marked as rejected or if the current Media-floor Control Entity binding of a Media used by the UE PoC Box and offered to the UE PoC Box is not the same as in the received SDP offer; or,
 - b) as specified in [OMA-PoC-UP] "*UE PoC Box procedures at PoC Session modification*", if the SDP answer contains an accepted Media which is not currently used by the UE PoC Box in the PoC Session or if the current Media-floor Control Entity binding of a Media used by the UE PoC Box and offered to the UE PoC Box is not the same as in the received SDP offer; or,
- 4. SHALL generate a SIP 200 "OK" response as specified in subclause 8.1.4 "*PoC Box receiving a request to add and disconnect Media Streams*"; and,
 - 5. SHALL send the SIP 200 "OK" response towards the PoC Server according to rules and procedures of SIP/IP Core.

When the SIP/IP Core corresponds to 3GPP/3GPP2 IMS, the UE PoC Box SHALL use 3GPP/3GPP2 IMS mechanisms according to rules and procedures of [3GPP TS 24.229] / [3GPP2 X.S0013.4] with the clarifications given in this subclause.

8.3.7 UE PoC Box receiving a Discrete Media in a SIP MESSAGE request

If the UE PoC Box supports receiving and storing Discrete Media, and receives a SIP MESSAGE request in the SIP dialog used for the recorded PoC Session, the PoC Box:

- 1. SHALL perform the actions specified in [OMA_IM_TS_Endorsement] "*PoC Client receives SIP MESSAGE*";
- 2. SHALL generate SIP 200 "OK" response as described in [OMA_IM_TS_Endorsement] "*PoC Client receives SIP MESSAGE*".
- 3. SHOULD store the received content of the SIP MESSAGE request; and,
- 4. SHALL store the PoC Address or Nick Name or both retrieved from the message/cpim From header in the SIP MESSAGE request body, if the corresponding Media is stored.

NOTE: The SIP MESSAGE carrying Discrete Media is not delivered to the UE PoC Box if UE PoC Box has not registered the feature tag.

When the SIP/IP Core corresponds with 3GPP/3GPP2 IMS, the UE PoC Box SHALL use 3GPP/3GPP2 IMS Session establishment mechanisms according to rules and procedures of [3GPP TS 24.229] / [3GPP2 X.S0013.4] with the clarifications given in this subclause.

Appendix A. Static Conformance Requirements (SCR) (Normative)

Annex A defines the MANDATORY (M) and OPTIONAL (O) PoC Control Plane (CP) functionality static conformance requirements (SCR). Mandatory Group Management Service Enabler (GMSE) and optional Presence Service Enabler (PRSE) functions, as required for the PoC enabler, are also referenced in these tables.

The SCRs defined in the following tables include SCR for:

- PoC Client;
- PoC Server performing the Participating PoC Function; and,
- PoC Server performing the Controlling PoC Function.

The SCRs are defined as described in [OMA_SCR_Rules].

Each SCR table identifies a list of supported features as:

- Item: Identifier for a feature. It MUST be of type ScrItem.
- Function: Short description of the feature.
- Reference: Section(s) of the specification(s) with more details on the feature.
- Requirement: Other features required by this feature, independent of whether those other features are mandatory or optional. The notation in the dependency grammar MUST be used for this column when other features are required; else the column MUST be left empty.

Dependency grammar used in this section is specified in [OMA_SCR_Rules]:

```
TerminalExpression = ScrReference
/ NOT TerminalExpression
/ TerminalExpression LogicalOperator TerminalExpression
/ "(" TerminalExpression ")"

ScrReference = ScrItem
/ ScrGroup

ScrItem = SpecScrName "-" GroupType "-" DeviceType "-" NumericId "-" Status
/ SpecScrName "-" DeviceType "-" NumericId "-" Status

ScrGroup = SpecScrName ":" FeatureType
/ SpecScrName "-" GroupType "-" DeviceType "-" FeatureType

SpecScrName = 1*Character;
GroupType = 1*Character;
DeviceType = "C" / "S"; C – client, S – server
NumericId = Number Number Number
Status = "M" / "O"; M - Mandatory, O - Optional
LogicalOperator = "AND" / "OR"; AND has higher precedence than OR and OR is inclusive
FeatureType = "MCF" / "OCF" / "MSF" / "OSF";
Character = %x41-5A;
```

Note: The following convention applies for the labels regarding the PoC version:

- PoCv1.0 - SCR Item that is the same in PoCv2.0 as it is in PoCv1.0
- PoCv2.0 - SCR Item that is new in PoCv2.0
- PoCv1.0mod - SCR Item that exists in PoCv1.0, but modifications in PoCv2.0

A.1 General High level external dependencies (GEN)

A.1.1 PoC Client

Item	Function	Reference	Requirement
PoC_CP-GEN-C-001-M	Backward compatibility with the mandatory client functions PoCv2.0	6.1A, [OMA-POC-1-CP]	[OMA-POC-1-CP]:MCF
PoC_CP-GEN-C-002-O	Backward compatibility with the optional client functions PoCv2.0	6.1A [OMA-POC-1-CP]	[OMA-POC-1-CP]:OCF

A.1.2 PoC Server

Item	Function	Reference	Requirement
PoC_CP-GEN-S-001-M	Backward compatibility with the mandatory server functions PoCv2.0	7.2.2a 7.3.1a, 7.3.2a, [OMA-POC-1-CP]	[OMA-POC-1-CP]:MSF
PoC_CP-GEN-S-002-O	Backward compatibility with the optional server functions PoCv2.0	7.2.2a 7.3.1a, 7.3.2a, [OMA-POC-1-CP]	[OMA-POC-1-CP]:OSF

A.2 PoC service registration (REG)

A.2.1 PoC Client

Item	Function	Reference	Requirement
POC_CP-REG-C-001-M	PoC service registration with SIP/IP Core PoCv1.0mod	6.1.1.1	POC_CP-REG-C-002-O OR POC_CP-REG-C-003-O
POC_CP-REG-C-002-O	PoC service registration per 3GPP IMS PoCv1.0mod	6.1.1.1	
POC_CP-REG-C-003-O	PoC service registration per 3GPP2 IMS PoCv1.0mod	6.1.1.1	
POC_CP-REG C-004-M	PoC service re-registration. PoCv1.0mod	6.1.1.1	POC_CP-REG-C-002-O OR POC_CP-REG-C-003-O

POC_CP-REG-C-005-M	PoC service deregistration PoCv1.0mod	6.1.1.2	
POC_CP-REG-C-006-M	PoC Client: PoC Service Setting procedure – initiation of SIP PUBLISH request for initial setting of PoC Service Settings PoCV1.0mod	6.1.1.1, 6.1.2	
POC_CP-REG-C-007-M	PoC Client: Inclusion of mandatory PoC Service Settings in initial PUBLISH request: answer mode, ISB, IAB, SSS PoCV2.0	6.1.1.1, 6.1.2	
POC_CP-REG-C-008-O	PoC Client: Indication of setting results after receiving SIP 200 "OK" response to PUBLISH request for initial setting of PoC Service Settings PoCV1.0	6.1.2	

A.2.2 PoC Server

Item	Function	Reference	Requirement
POC_CP-REG-S-001-M	Participating PoC Function: setting of PoC Service Setting procedure (processing the initial SIP PUBLISH requests) PoCV1.0	7.3.1.14	

A.3 PoC Session Initiation, Joining, Release (SJR)

A.3.1 PoC Client

Item	Function	Reference	Requirement
Session Initiation, Joining			
Originating Client Procedures			
POC_CP-SJR-C-001-M	General Initiation – SIP INVITE request PoCV1.0mod	6.1.3.1 6.1.3.1.a	
POC_CP-SJR-C-002-O	General Initiation: Includes a Nick Name in the Authenticated Originator's PoC Address. PoCV1.0	6.1.3.1, 5.4	

POC_CP-SJR-C-003-O	General Initiation: Includes media content in one or more MIME types PoCV2.0	6.1.3.1	
POC_CP-SJR-C-004-O	General Initiation: Includes text content in subject header PoCV2.0	6.1.3.1	
POC_CP-SJR-C-005-O	General Initiation: Includes reference to media content PoCV2.0	6.1.3.1	
POC_CP-SJR-C-006-M	On-demand Session establishment: PoCV1.0mod	6.1.3.3 6.1.3.1 6.1.3.1.a	
POC_CP-SJR-C-007-M	PoC Client sending SIP INVITE request: On-demand Session establishment, Ad-hoc PoC Group Session, Confirmed Indication, Invited PoC Client: Automatic Answer Mode. PoCV1.0mod	6.1.3.1 6.1.3.1.a 6.1.3.3.1 6.2.1.2	
POC_CP-SJR-C-008-M	PoC Client sending SIP INVITE request: On-demand Session establishment, 1-1 PoC Session, Confirmed Indication, Invited PoC Client: Automatic Answer Mode. PoCV1.0mod	6.1.3.1 6.1.3.1.a 6.1.3.3.1 6.2.1.2	
POC_CP-SJR-C-009-O	PoC Client receiving SIP 180 "Ringing" response to initiation of On-demand Session, Ad-hoc PoC Group Session and 1-1 PoC Session PoCV1.0mod	6.1.3.1 6.1.3.1.a 6.1.3.3.1	
POC_CP-SJR-C-010-M	PoC Client receiving SIP 200 "OK" response to initiation of On-demand Session, Ad-hoc PoC Group Session and 1-1 PoC Session PoCV1.0mod	6.1.3.1 6.1.3.1.a 6.1.3.3.1	
POC_CP-SJR-C-011-O	On-demand Session establishment: Notify Media Burst Control Scheme PoCV1.0mod	6.1.3.1 6.1.3.1.a 6.1.3.3.1	

POC_CP-SJR-C-012-O	On-demand Session establishment: Ad-hoc PoC Group Session and 1-1 PoC Session setup for Unconfirmed Indication PoCV1.0mod	6.1.3.1 6.1.3.1.a 6.1.3.3.1	
POC_CP-SJR-C-013-M	On-demand Session establishment: Pre-arranged PoC Group Session - Confirmed Indication, Invited PoC Client: Automatic Answer Mode. PoCV1.0mod	6.1.3.1 6.1.3.1.a 6.1.3.3.2, 6.2.1.2	
POC_CP-SJR-C-014-M	On-demand Session establishment: Ad-hoc PoC Group Session, Invited PoC Client: Manual Answer Mode. PoCV1.0mod	6.1.3.1 6.1.3.1.a 6.1.3.3.1, 6.2.1.3	
POC_CP-SJR-C-015-M	On-demand Session establishment: 1-1 PoC Session Invited PoC Client Manual Answer Mode. PoCV1.0mod	6.1.3.1 6.1.3.1.a 6.1.3.3.1, 6.2.1.3	
POC_CP-SJR-C-016-M	On-demand Session establishment: Pre-arranged PoC Group Session - Invited PoC Client Manual Answer Mode. PoCV1.0mod	6.1.3.1 6.1.3.1.a 6.1.3.3.2 6.2.1.3	
POC_CP-SJR-C-017-M	On-demand Session establishment: joining a Chat PoC Group Session PoCV1.0mod	6.1.3.1 6.1.3.1.a 6.1.3.3.2	
POC_CP-SJR-C-018-M	On-demand Session establishment: PoC Client re-joining a PoC Session PoCV1.0mod	6.1.3.1 6.1.3.1.a 6.1.5.1	
POC_CP-SJR-C-019-O	Pre-established Session establishment PoCV1.0mod	6.1.3.1 6.1.3.1.a 6.1.3.2 6.1.3.2.1	
POC_CP-SJR-C-020-O	Pre-established Session : Ad-hoc PoC Group Session initiation (PoC Client sending SIP REFER request) PoCV1.0mod	6.1.3.2.2	POC_CP-SJR-C-019-O
POC_CP-SJR-C-021-O	Pre-established Session: 1-1 PoC Session initiation	6.1.3.2.2	POC_CP-SJR-C-019-O

	(PoC Client sending SIP REFER request) PoCV1.0mod		
POC_CP-SJR-C-022-O	Pre-established Session: Display of indication to PoC User of acceptance/rejection of PoC Session PoCV1.0mod	6.1.3.2.2 6.1.3.2.3	POC_CP-SJR-C-0192-O AND POC_CP-SJR-C-020-O OR POC_CP-SJR-C-021-O OR POC_CP-SJR-C-023-O
POC_CP-SJR-C-023-O	Pre-established Session: PoC Client initiates Pre-arranged PoC Group Session, or joins Chat PoC Group Session (sending SIP REFER request) PoCV1.0mod	6.1.3.2.3	POC_CP-SJR-C-019-O
POC_CP-SJR-C-024-O	Pre-established Session: PoC Client releases a Pre-established Session PoCV1.0mod	6.1.3.2.4	POC_CP-SJR-C-019-O
POC_CP-SJR-C-025-O	Pre-established Session: Re-joining a PoC Session PoCV1.0mod	6.1.5.2	POC_CP-SJR-C-019-O
Terminating Client Procedures			
POC_CP-SJR-C-026-M	PoC Client invited to a PoC Session: General INVITE procedure PoCV1.0mod	6.2.1.1 5.4	POC_CP-SJR-C-027-O OR POC_CP-SJR-C-028-O POC_CP
POC_CP-SJR-C-027-O	PoC Client invited to a PoC Session: Automatic Answer Mode PoCV1.0mod	6.2.1.2 6.2.1.1.a	
POC_CP-SJR-C-028-O	PoC Client invited to a PoC Session: Manual Answer Mode PoCV1.0mod	6.2.1.3 6.2.1.1.a	
POC_CP-SJR-C-029-O	PoC Client invited to a PoC Session: Manual Answer Override PoCV1.0mod	6.2.1.2 6.2.1.1.a	
Releasing/ Leaving a Session			
Originating Client Procedures			
POC_CP-SJR-C-030-M	On Demand Session: Leaving a PoC Session: Release the floor PoCV1.0	6.1.6.1	
POC_CP-SJR-C-031-M	On Demand Session: Leaving a PoC Session SIP BYE PoCV1.0	6.1.6.1	
POC_CP-SJR-C-032-O	Pre-established Session:	6.1.6.2	

	Leaving a PoC Session: Generate SIP REFER PoCV1.0		
POC_CP-SJR-C-033-O	Pre-established Session: Leaving a PoC Session - receive SIP NOTIFY PoCV1.0	6.1.6.2	
POC_CP-SJR-C-034-O	Pre-established Session: Leaving a PoC Session – display information contained in SIP NOTIFY PoCV1.0	6.1.6.2	POC_CP-SJR-C-033-O
POC_CP-SJR-C-035-O	On-demand Session: Releasing a PoC Session: Release the floor PoCV1.0	6.1.16.1	
POC_CP-SJR-C-036-M	On Demand Session: Releasing a PoC Session PoCV1.0	6.1.16.1	POC_CP-SJR-C-035-O
POC_CP-SJR-C-037-O	Pre-established Session: Releasing a PoC Session PoCV1.0	6.1.16.2	POC_CP-SJR-C-035-O
POC_CP-SJR-C-038-O	Pre-established Session: Releasing a PoC Session - receive SIP NOTIFY PoCV1.0	6.1.16.2	POC_CP-SJR-C-035-O
POC_CP-SJR-C-039-O	Pre-established Session: Releasing a PoC Session – display information contained in SIP NOTIFY PoCV1.0	6.1.16.2	POC_CP-SJR-C-035-O AND POC_CP-SJR-C-038- O
Terminating Client Procedures			
POC_CP-SJR-C-040-M	PoC Client receiving a PoC Session Release Request: On-demand case PoCV1.0	6.2.3.1	
POC_CP-SJR-C-041-O	PoC Client receiving a PoC Session Release Request: Pre-established case PoCV1.0	6.2.3.2	POC_CP-SJR-C-037-O
Cancel a PoC Session			
POC_CP-SJR-C-042-M	Originating PoC Client canceling a PoC Session initiation - on-demand case PoCV1.0	6.1.11.1	
POC_CP-SJR-C-043-M	Terminating PoC Client support of reception of the SIP CANCEL	6.2.6.1	

	request: On-demand case PoCV1.0		
--	------------------------------------	--	--

A.3.2 PoC Server

Item	Function	Reference	Requirement
Participating PoC Function			
Processing requests initiated by Served User			
POC_CP-SJR-S-001-M	General process for SIP INVITE requests and SIP 200 "OK" responses during PoC Session initiation PoCV1.0mod	7.3.1.1	POC_CP-SJR-S-002-M OR POC_CP-SJR-S-003-O
POC_CP-SJR-S-002-M	SDP offer generation: on demand case PoCV2.0	7.3.1.1a	
POC_CP-SJR-S-003-O	SDP offer generation: pre-established case PoCV2.0	7.3.1.1b	POC_CP-SJR-S-006-O OR POC_CP-SJR-S-011-O
POC_CP-SJR-S-004-M	SDP answer generation PoCV2.0	7.3.1.1c	POC_CP-SJR-S-007-O OR POC_CP-SJR-S-008-O OR POC_CP-SJR-S-009-O
POC_CP-SJR-S-005-O	Includes the Nick Name in the Authenticated Originator's PoC Address PoCV1.0	7.3.1.1, 7.3.2.1	
POC_CP-SJR-S-006-O	Pre-established Session initiation requests PoCV1.0mod	7.3.1.2 7.3.1.1.b	POC_CP-SJR-S-007-O OR POC_CP-SJR-S-008-O
POC_CP-SJR-S-007-O	Respond to Pre-established Session requests with SIP 403 "Forbidden" response if feature is not supported PoCV1.0	7.3.1.2	
POC_CP-SJR-S-008-O	Respond to Pre-established Session requests for case where feature is supported PoCV1.0	7.3.1.2	
POC_CP-SJR-S-009-O	Pre-established Session modification request to change media capabilities while not in a PoC Session PoCV2.0	7.3.1.3	POC_CP-SJR-S-006-O AND POC_CP-SJR-S-007-O
POC_CP-SJR-S-010-M	PoC Session initiation using On-demand Session PoCV1.0mod	7.3.1.4 7.3.1.1.a	

POC_CP-SJR-S-011-O	PoC Session Initiation Using Pre-established Session PoCV1.0mod	7.3.1.5 7.3.1.1.b	
Processing requests terminated by Served User			
POC_CP-SJR-S-013-M	SDP offer generation PoCV1.0	7.3.2.1a E3	POC_CP-SJR-S-014-M OR POC_CP-SJR-S-015-O
POC_CP-SJR-S-014-M	SDP answer generation in on demand case PoCV1.0	7.3.2.1b E3	POC_CP-SJR-S-018-O OR POC_CP-SJR-S-020-M
POC_CP-SJR-S-015-O	SDP answer generation in pre-established case PoCV1.0mod	7.3.2.1c E3	POC_CP-SJR-S-019-O OR POC_CP-SJR-S-021-O
POC_CP-SJR-S-016-M	PoC Session invitation request PoCV1.0mod	7.3.2.1 7.3.2.1.a 7.3.2.2	
POC_CP-SJR-S-017-O	PoC Session Invitation request respecting QoE profiles PoCV1.0mod	7.3.2.1 7.3.2.1.a 7.3.2.2 E.3.2 5.8	
POC_CP-SJR-S-018-O	Automatic answer (On-demand Session) PoCV1.0mod	7.3.2.1 7.3.2.1.b 7.3.2.2.1	
POC_CP-SJR-S-019-O	Automatic answer (Pre-established Session) PoCV1.0mod	7.3.2.1 7.3.2.1.c 7.3.2.2.2	
POC_CP-SJR-S-020-M	Manual answer (On-demand Session) PoCV1.0mod	7.3.2.1 7.3.2.1.a 7.3.2.2.3	
POC_CP-SJR-S-021-O	Manual answer using Pre-established Session PoCV1.0mod	7.3.2.1 7.3.2.1.c 7.3.2.2.4	
Controlling PoC Function			
Requests terminated by the Controlling PoC Function			
POC_CP-SJR-S-024-M	General - Server behavior on receipt of SIP INVITE PoCV1.0mod	7.2.1.1 7.2.1.1.a	
POC_CP-SJR-S-025-O	General - Inclusion of supported SIP methods in the SIP 200 "OK" response PoCV1.0mod	7.2.1.1 7.2.1.1.a	
POC_CP-SJR-S-026-O	General – inclusion of media parameter in the MIME SDP body when sending SIP 488 "not acceptable here" PoCV1.0mod	7.2.1.1 7.2.1.1.a	

POC_CP-SJR-S-027-M	Ad-hoc PoC Group and 1-1 PoC Session setup request PoCV1.0mod	7.2.1.1 7.2.1.1.a 7.2.1.2	
POC_CP-SJR-S-028-M	Ad-hoc PoC Group and 1-1 PoC Session setup request with Confirmed Indication PoCV1.0mod	7.2.1.1 7.2.1.1.a 7.2.1.2	
POC_CP-SJR-S-029-O	Ad-hoc PoC Group and 1-1 PoC Session setup request with Unconfirmed Indication PoCV1.0mod	7.2.1.1 7.2.1.1.a 7.2.1.2 7.2.1.1.a	
POC_CP-SJR-S-030-M	Pre-arranged PoC Group Session setup request PoCV1.0mod	7.2.1.1 7.2.1.1.a 7.2.1.3 7.2.1.3.1	
POC_CP-SJR-S-031-M	Pre-arranged PoC Group Session setup request with Confirmed Indication in General PoCV1.0mod	7.2.1.1 7.2.1.1.a 7.2.1.3 7.2.1.3.1	
POC_CP-SJR-S-032-O	Pre-arranged PoC Group Session setup request with Unconfirmed Indication in General PoCV1.0mod	7.2.1.1 7.2.1.1.a 7.2.1.3 7.2.1.3.1	
POC_CP-SJR-S-033-M	Rejoining PoC Session request PoCV1.0	7.2.1.4	
POC_CP-SJR-S-035-M	Joining Chat PoC Group Session PoCV1.0	7.2.1.5	
Requests originated by the Controlling PoC Function			
POC_CP-SJR-S-037-M	General - PoC Server behavior when generating a SIP request: PoC Session invitation request and SDP offer generation PoCV1.0mod	7.2.2.1 7.2.2.2 7.2.2.1.a	
POC_CP-SJR-S-038-M	PoC Session invitation request with Confirmed Indication PoCV1.0mod	7.2.2.1 7.2.2.1.a 7.2.2.2	
POC_CP-SJR-S-039-O	PoC Session invitation request with Unconfirmed Indication PoCV1.0mod	7.2.2.1 7.2.2.1.a 7.2.2.2	

POC_CP-SJR-S-040-O	PoC Session invitation request: Alternative IP address or port number indication PoCV1.0mod	7.2.2.1 7.2.2.1.a 7.2.2.2	
POC_CP-SJR-S-041-M	PoC Session invitation request: PoC Session from Inviting PoC Client compliant only to the OMA PoC version 1.0 specification PoCV2.0	7.2.2.1	
Releasing/ Leaving a Session			
Participating PoC Function			
Processing requests initiated by Served User			
POC_CP-SJR-S-041-M	SIP BYE request (On-demand Session) PoCV1.0	7.3.1.10.1	
POC_CP-SJR-S-042-O	SIP REFER with method set to BYE (Pre-established Session) PoCV1.0	7.3.1.10.2	
POC_CP-SJR-S-043-O	SIP REFER BYE request (Pre-established Session) PoCV1.0	7.3.1.10.3	
POC_CP-SJR-S-044-O	Pre-established Session: Procedures of PoC Session release from User Plane PoCV1.0	7.3.1.15	
Processing requests terminated by Served User			
POC_CP-SJR-S-045-M	SIP BYE request (On-demand Session) PoCV1.0	7.3.2.6.1	
POC_CP-SJR-S-046-O	SIP BYE Request (Pre-established Session) PoCV1.0	7.3.2.6.2	
POC_CP-SJR-S-047-O	Leaving a PoC Session when using a Pre-established Session PoCV1.0	7.3.2.6.3	POC_CP-SJR-C-037-O
Controlling PoC Function			
Requests terminated by the Controlling PoC Function			
POC_CP-SJR-S-048-M	Leaving PoC Session request using SIP BYE PoCV1.0	7.2.1.9.1	
POC_CP-SJR-S-049-O	Processing requests for leaving a PoC Session (for Pre-established Session case) using SIP REFER	7.2.1.9.2	POC_CP-SJR-C-037-O

	PoCV1.0		
POC_CP_SJR-S-050-O	Processing requests for leaving a PoC Session (within Pre-established Session case) using SIP BYE PoCV2.0	7.2.1.9.3	POC_CP-SJR-C-037-O
Cancel a PoC Session			
POC_CP-SJR-S-051-M	Participating PoC Server processing requests initiated by served PoC User sending SIP CANCEL request PoCV1.0	7.3.1.9	
POC_CP-SJR-S-052-M	Participating PoC Server processing requests terminated by served PoC User sending SIP CANCEL request PoCV1.0	7.3.2.5	
POC_CP-SJR-S-053-M	Requests terminated by the Controlling PoC Function: Cancel PoC Session setup request PoCV1.0	7.2.1.10	
POC_CP-SJR-S-054-M	Requests initiated by the Controlling PoC Function: Cancel of PoC Session invitation request PoCV1.0	7.2.2.4	

A.4 PoC Session-related Features (SRF)

A.4.1 PoC Client

Item	Function	Reference	Requirement
Session Modification			
POC_CP-SRF-C-001-M	PoC Session modification: General procedures: INVITE request PoCV1.0	6.1.4.1	
POC_CP-SRF-C-002-O	PoC Session modification: General procedures – SIP UPDATE request PoCV1.0	6.1.4.1	
POC_CP-SRF-C-003-O	PoC Session modification: PoC Client placing Media on hold	6.1.4.2	POC_CP-SRF-C-004-O

	PoCV1.0mod		
POC_CP-SRF-C-004-O	PoC Session modification: PoC Client placing Media off hold PoCV1.0mod	6.1.4.3	POC_CP-SRF-C-003-O
POC_CP-SRF-C-005-O	PoC Session modification: User Plane adaptation: Modifying Media capabilities during an ongoing PoC Session PoCV1.0mod	6.1.4.4	
POC_CP-SRF-C-006-M	PoC Session modification: SIP Session refresh (receiving 200OK) PoCV1.0	6.1.4.5	
POC_CP-SRF-C-007-O	PoC Session modification: SIP Session expiration PoCV1.0	6.1.4.5	
POC_CP-SRF-C-008-O	PoC Session modification: Adding and disconnecting Media PoCV2.0	6.1.4.6	
POC_CP-SRF-C-009-O	PoC Session modification: Adding and disconnecting Media (receiving 200OK) PoCV2.0	6.1.4.6	POC_CP-SRF-C-008-O
Originating Client Procedure			
POC_CP-SRF-C-010-M	PoC Session modification: Adding PoC User to PoC Session: Invited PoC User in Manual Answer Mode (sending REFER message and receiving NOTIFY request sharing REFER's dialog) PoCV1.0mod	6.1.7	
POC_CP-SRF-C-011-M	PoC Session modification: Adding a PoC User to PoC Session: Invited PoC User in Automatic Answer Mode (sending REFER message and receiving NOTIFY request sharing REFER's dialog) PoCV1.0mod	6.1.7	

POC_CP-SRF-C-012-O	Adding a PoC User - notification to the PoC User about the information received in the body of the NOTIFY request: in Ad-hoc PoC Group, Pre-arranged PoC Group. PoCV1.0mod	6.1.7	
Terminating Client Procedures			
POC_CP-SRF -C-013-M	PoC Client receiving a PoC Session modification request (send SIP 200 OK after receiving SIP UPDATE or SIP re-INVITE) PoCV1.0	6.2.2, 6.2.2.a	
POC_CP-SRF -C-014-M	PoC Client receiving a PoC Session modification request (user plane adaptation) PoCV1.0	6.2.2.b, 6.2.1.1.a	POC_CP-SRF -C-013-O
POC_CP-SRF -C-015-O	PoC Client receiving request to add and disconnect media (send SIP 200 OK) PoCV1.0	6.2.2.c, 6.2.1.1.a	POC_CP-SRF -C-013-O
Sending Discrete Media			
POC_CP-SRF-C-016-O	Originating PoC Client sending a Discrete Media as a SIP MESSAGE PoCV2.0	6.1.15 [OMA-IM-TS]	[OMA-IM-TS]: ERELD:MSF Section "pager mode"
POC_CP-SRF-C-017-O	Terminating PoC Client receiving Discrete Media in SIP MESSAGE PoCV2.0	6.2.8 [OMA-IM-TS]	[OMA-IM-TS]: ERELD:MSF Section "pager mode"

A.4.2 PoC Server

Item	Function	Reference	Requirement
Session Modification			
Participating PoC Function			
Processing requests initiated by Served User			
POC_CP-SRF-S-001M	PoC Session modification request during an ongoing PoC Session PoCV1.0mod	7.3.1.6	POC_CP-SRF-S-002-O OR POC_CP-SRF-S-003-O

POC_CP-SRF-S-002-O	PoC Session modification request during an ongoing PoC Session if feature is not supported PoCV1.0mod	7.3.1.6	
POC_CP-SRF-S-003-O	PoC Session modification request during an ongoing PoC Session if feature is supported PoCV1.0mod	7.3.1.6	
POC_CP-SRF-S-004-M	SIP SUBSCRIBE requests containing URIs not owned by this PoC Server PoCV1.0	7.3.1.7	
POC_CP-SRF-S-005-M	SIP REFER request containing URIs not owned by this PoC Server PoCV2.0	7.3.1.8	
POC_CP-SRF-S-006-O	Responding to SIP REFER requests when Pre-established Session is supported PoCV1.0	7.3.1.8	
Processing requests terminated by Served User			
POC_CP-SRF-S-007-M	PoC Session Modification PoCV1.0	7.3.2.3	
POC_CP-SRF-S-008-M	SIP NOTIFY request PoCV1.0	7.3.2.4	
Controlling PoC Function			
Requests terminated by the Controlling PoC Function			
POC_CP-SRF-S-009-M	PoC Session modification (changes to media capabilities) PoCV1.0mod	7.2.1.7 7.2.2.5 7.2.1.1a	
POC_CP-SRF-S-010-O	Updating of media capabilities according to local policy PoCV1.0mod	7.2.1.7 7.2.2.5 7.2.1.1a	
POC_CP-SRF-S-011-M	Adding Participants to PoC Session PoCV1.0mod	7.2.1.8	
POC_CP-SRF-S-012-O	PoC Server terminating the implicit subscription and indicating to the PoC Client PoCV1.0mod	7.2.1.8 7.2.1.17	

Sending Discrete Media			
POC_CP-SRF-S-013-M	PoC Server roles establishment: Discrete Media request PoCV2.0	7.2.1.23 [OMA-IM-TS]	[OMA-IM-TS]: ERELD:MSF Section "pager mode"
POC_CP-SRF-S-014-M	Participating PoC Function- Processing requests initiated by the served PoC User: Discrete Media request PoCV2.0	7.3.1.16 [OMA-IM-TS]	[OMA-IM-TS]: ERELD:MSF Section "pager mode"
POC_CP-SRF-S-015-M	Participating PoC Function- Processing requests terminated by the served PoC User: Discrete Media PoCV2.0	7.3.2.8 [OMA-IM-TS]	[OMA-IM-TS]: ERELD-MSF Section "pager mode"
POC_CP-SRF-S-016-M	Requests initiated by Controlling PoC Function: Discrete Media request PoCV2.0	7.2.2.3 [OMA-IM-TS]	[OMA-IM-TS]: ERELD-MSF Section "pager mode"
POC_CP-SRF-S-017-M	Requests received by Controlling PoC Function: Discrete Media request PoCV2.0	7.2.2.7 [OMA-IM-TS]	[OMA-IM-TS]: ERELD-MSF Section "pager mode"
PoC Server Role Establishment			
POC_CP-SRF-S-018-M	Determination of PoC Server role as a Participating and/or Controlling PoC Function PoCV1.0	7.1	
POC_CP-SRF-S-019-M	Reception of initial SIP INVITE request – mobile initiating trigger detection point PoCV1.0	7.1.1 7.3.2.1 7.3.1.4	
POC_CP-SRF-S-020-O	Replace warning text with text in specified language PoCV2.0	7.2.1.1b 5.6	
POC_CP-SRF-S-021-M	PoC Server role establishment: Reception of initial SIP INVITE request – Controlling PoC Function PoCV1.0	7.1.1 7.2.1.1b 7.2.1.3 7.2.1.4 7.2.1.5	
POC_CP-SRF-S-022-M	PoC Server role establishment: Reception of initial SIP INVITE request – Participating PoC Function PoCV1.0	7.1.1 7.3.2.2	

POC_CP-SRF-S-023-M	PoC Server role establishment: Reception of initial SIP INVITE request – SIP URI unknown, send SIP 404 PoCV1.0	7.1.1	
POC_CP-SRF-S-024-O	PoC Server role establishment: Forward to PoC Box if Unconditional forward invitations is set to true PoCV1.0	7.1.1 7.3.2.2.5.1	POC_CP-PBO-C-005-O
POC_CP-SRF-S-025-M	PoC Server role establishment: Reception of SIP REFER request, if originating PoC service trigger PoCV1.0	7.1.2 7.3.1.8	
POC_CP-SRF-S-026-M	PoC Server role establishment: Reception of SIP REFER request, if terminating PoC service trigger PoCV1.0	7.1.2 7.2.1.x 7.2.1.8 7.2.1.9.2 7.2.1.9.4	
POC_CP-SRF-S-027-M	PoC Server role establishment: Reception of SIP MESSAGE request PoCV1.0mod	7.1.3 7.3.1.16 7.3.2.8 7.2.1.23 7.3.1.4 7.3.1.5 7.3.2.2	POC_CP-SRF-S-013-O OR POC_CP-FDC-C-002-O
POC_CP-SRF-S-028-M	PoC Server role establishment: Reception of SIP SUBSCRIBE request PoCV1.0mod	7.1.4 7.3.1.7	
Session Policy Control Procedures			
POC_CP-SRF-S-029-M	PoC Session joining policy PoCV1.0	7.2.1.6	
POC_CP-SRF-S-030-M	PoC Session initiation policy PoCV1.0	7.2.1.14	
POC_CP-SRF-S-031-M	PoC Session initiation policy for Pre-arranged PoC Group Session PoCV1.0	7.2.1.14.1	
POC_CP-SRF-S-034-M	PoC Session adding policy PoCV2.0	7.2.1.15	
POC_CP-SRF-S-035-M	PoC Session release policy	7.2.1.16	

	PoCV2.0		
POC_CP-SRF-S-037-M	PoC Session Participant information policy PoCV2.0	7.2.1.18	
POC_CP-SRF-S-039-O	Group Advertisement policy PoCV2.0	7.2.1.20	
POC_CP-SRF-S-040-M	Adding Media to a PoC Session policy PoCV2.0	7.2.1.21	
POC_CP-SRF-S-041-M	Remove Media from a PoC Session policy PoCV2.0	7.2.1.22	
SIP Session Timer			
POC_CP-SRF-S-045-M	Processing of SIP Session timer expiry PoCV1.0	7.3.1.13	
Subscribing to Participant Information			
POC_CP-SRF-S-046-O	Requests initiated by the PoC Server performing the Participating PoC Function: Subscribing to Participant information PoCv2.0	7.3.3.1	

A.5 Session-unrelated Features (SUF)

A.5.1 PoC Client

Item	Function	Reference	Requirement
POC_CP-SUF-C-001-M	Originating PoC Client Privacy requested by PoC User PoCV1.0	6.1.3.1	
POC_CP-SUF-C-002-O	Originating PoC Client subscription to the conference state event package (sending SIP SUBSCRIBE request) for Pre-established Session PoCV1.0	6.1.10	
POC_CP-SUF-C-003-O	Originating PoC ClientsSubscription to the conference state event package (sending SIP SUBSCRIBE request) for On-demand Session PoCV1.0	6.1.10	

Group Advertisement			
POC_CP-SUF-C-004-O	PoC Client Receiving a Group Advertisement PoCV1.0	6.2.5	
POC_CP-SUF-C-005-O	PoC Client Sending a Group Advertisement (sending SIP MESSAGE) PoCV1.0	6.1.9	
Instant Personal Alert			
POC_CP-SUF-C-006-O	Originating PoC Client Sending an Instant Personal Alert (sending SIP MESSAGE) PoCV1.0	6.1.8	
POC_CP-SUF-C-007-M	Terminating PoC Client receiving an Instant Personal Alert: receiving SIP MESSAGE PoCV1.0	6.2.4	POC_CP-SUF-C-0016-O OR POC_CP-SUF-C-0017-O
POC_CP-SUF-C-0016-O	Terminating PoC Client receiving an Instant Personal Alert: rejecting received MESSAGE message. PoCV1.0	6.2.4	
POC_CP-SUF-C-0017-O	Terminating PoC Client receiving an Instant Personal Alert: sending 200 OK response to received MESSAGE message. PoCV1.0	6.2.4	
POC_CP-SUF-C-008-O	Terminating PoC Client receiving an Instant Personal Alert: initiating 1-1 PoC Session PoCV1.0	6.2.4	
PoC Service Settings			
POC_CP-SUF-C-009-O	PoC Client: PoC Service Setting procedure – initiation of SIP PUBLISH request (PUBLISH for update, removal, or refresh of PoC Service Settings) PoCV1.0mod	6.1.2	

POC_CP-SUF-C-010-O	PoC Client: Indication of setting results after receiving SIP 200 "OK" response to PUBLISH for update, removal, or refresh of PoC Service Settings PoCV1.0	6.1.2	
POC_CP-SUF-C-016-O	Setting of the "Privacy" PoC Service Setting. PoCV2.0	6.1.1.1, 6.1.2	
Presence			
POC_CP-SUF-C-013-O	Presence procedures PoCV1.0	C.3	POC_CP-SUF-C-014-O OR POC_CP-SUF-C-018-O
POC_CP-SUF-C-014-O	The PoC Client collaborates with the presence source and watcher entities when residing in the same UE. PoCV1.0	C.3	POC_CP-SUF-C-013-O
POC_CP-SUF-C-015-O	Only when the PoC Server is not enabled to publish presence information on behalf of the PoC User, then the Presence Source residing in the same UE as the PoC Client publishes the presence information for the elements specified in subclause C.1 <i>"Availability for PoC-Session Service"</i> . PoCV1.0	C.3	POC_CP-SUF-C-013-O

A.5.2 PoC Server

Item	Function	Reference	Requirement
POC_CP-SUF-S-001-M	Controlling PoC Function: PoC Session Participant information requests PoCV1.0	7.2.1.11 7.2.1.11.1 7.2.1.11.2 7.2.1.18	
POC_CP-SUF-S-002-M	Controlling PoC Function: Terminate subscriptions for terminated PoC Sessions PoCV1.0	7.2.1.11.3	

POC_CP-SUF-S-003-O	Controlling PoC Function: Sending of SIP NOTIFY when subscribed state changes PoCV1.0	7.2.1.11.1	
POC_CP-SUF-S-004-O	Controlling PoC Function: Limiting rate of SIP NOTIFY requests PoCV1.0	7.2.1.11.2	POC_CP-SUF-S-003-O
POC_CP-SUF-S-005-O	Controlling PoC Function: PoC Server should avoid sending SIP Notify to a PoC Client at the same time as a Talk Burst is sent or received from same PoC Client PoCV1.0	7.2.1.11.2	
POC_CP-SUF-S-006-M	Requests terminated by Controlling PoC Function: SIP Session refresh procedure PoCV1.0	7.2.1.13	
POC_CP-SUF-S-007-M	Requests initiated by Controlling PoC Function: Removal of Participant from PoC Session PoCV1.0	7.2.2.4	
POC_CP-SUF-S-008-O	Requests initiated by Controlling PoC Function: PoC Session modification of media capabilities for one SIP Session in an ongoing PoC Session PoCV1.0	7.2.2.5	
Group Advertisement			
POC_CP-SUF-S-009-O	Participating PoC Function processing requests initiated by the served PoC User: Group Advertisement request PoCV1.0	7.3.1.11	
POC_CP-SUF-S-010-O	Participating PoC Function processing requests terminated by the Served PoC User: Group Advertisement requests (receive SIP MESSAGE) PoCV1.0	7.3.2.7	POC_CP-SUF-S-011-O OR POC_CP-SUF-S-012-O

POC_CP-SUF-S-011-O PoCV1.0	Participating PoC Function processing requests terminated by the Served PoC User: Group Advertisement request reject when not supported by the PoC Server PoCV1.0	7.3.2.7	
POC_CP-SUF-S-012-O	Participating PoC Function processing requests terminated by the served PoC User: Group Advertisement request procedure when feature is supported PoCV1.0	7.3.2.7	
POC_CP-SUF-S-013-O	Participating PoC Function processing requests terminated by the served PoC User: Group Advertisement respecting privacy PoCV1.0	7.3.2.7	
POC_CP-SUF-S-014-O	Requests terminated by Controlling PoC Function: Group Advertisement requests (SIP MESSAGE request) PoCV1.0	7.2.1.12	POC_CP-SUF-S-015-O OR POC_CP-SUF-S-016-O
POC_CP-SUF-S-015-O	Requests terminated by Controlling PoC Function: Group Advertisement request reject when not supported by the PoC Server PoCV1.0	7.2.1.12	
POC_CP-SUF-S-016-O	Requests terminated by Controlling PoC Function: Group Advertisement request procedure when feature is supported PoCV1.0	7.2.1.12	
POC_CP-SUF-S-017-O PoCV1.0	Requests initiated by Controlling PoC Function: Group Advertisement request sending	7.2.2.7	
Instant Personal Alert			
POC_CP-SUF-S-018-M	Instant Personal Alert procedure at originating PoC Server PoCV1.0	7.4.1.1	

POC_CP-SUF-S-019-M	Instant Personal Alert procedure at terminating PoC Server PoCV1.0	7.4.1.2	
PoC Service Settings			
POC_CP-SUF-S-020-M	Participating PoC Function: update, removal, or refresh PoC Service Setting procedure (processing SIP PUBLISH requests) PoCV1.0	7.3.1.14	
POC_CP-SUF-S-028-O	Acceptance procedures for the "Privacy" PoC Service Setting. PoCV2.0	7.3.1.14	
Conference URI			
POC_CP-SUF-S-021-M	Handling of a request URI of a Conference-Factory-URI that is not allocated on the PoC Server PoCV1.0	7.5.1	
POC_CP-SUF-S-022-M	Handling of a SIP INVITE with a request URI of a Conference URI that is not allocated on the PoC Server performing the Controlling PoC Function PoCV1.0	7.5.2	
Presence			
POC_CP-SUF-S-023-O	PoC Server acting as a presence source PoCV1.0	C.2.1	POC_CP-SUF-S-024-O AND POC_CP-SUF-S-025-O AND POC_CP-SUF-S-026-O
POC_CP-SUF-S-024-O	PoC Server acting as a presence source for PoC Registration and de-registration PoCV1.0	C.2.1.1	POC_CP-SUF-S-023-O
POC_CP-SUF-S-025-O	PoC Server sets the "PoC-Session participation" presence information element to the value of "closed" (as defined in subclause C.1.5 " <i>PoC Session participation</i> ") at registration and de-registration. PoCV1.0	C.2.1.1	POC_CP-SUF-S-024-O

POC_CP-SUF-S-026-O	PoC Server acting as a presence source for Incoming PoC Session Barring (ISB) PoCV1.0	C.2.1.2	POC_CP-SUF-S-023-O
POC_CP-SUF-S-027-O	PoC Server acting as a presence source for Incoming Instant Personal Alert Barring (IAB) PoCV1.0	C.2.1.3	POC_CP-SUF-S-023-O

A.6 PoC Box (PBO)

A.6.1 UE PoC Box (client functionality)

Item	Function	Reference	Requirement
POC_CP-PBO-C-001-O	Register with UE PoC Box feature tags and the contact address of the UE PoC Box. PoCV2.0	6.1.1.1	POC_CP-REG-C-001-M
POC_CP-PBO-C-002-O	Setting of "PoC Box use" PoC Service Setting. PoCV2.0	6.1.2	
POC_CP-PBO-C-003-O	De-Register with UE PoC Box feature tag PoCV2.0	6.1.1.2	POC_CP-REG-C-005-M
POC_CP-PBO-C-004-O	Reject routing to recipient's PoC Box PoCV2.0	6.1.3.3.1 6.1.3.3.2	
POC_CP-PBO-C-005-O	Enforce routing to recipient's PoC Box PoCV2.0	6.1.3.3.1 6.1.3.3.2	POC_CP-PBO-C-006-O
POC_CP-PBO-C-006-O	Notification of PoC Session establishment with PoC Box in 200OK response for feature tag 'sip.automata' PoCV2.0	6.1.3.3.1 6.1.3.3.2	POC_CP-PBO-C-005-O
POC_CP-PBO-C-007-O	Notification of PoC Session establishment with UE PoC Box in 200OK response for feature tag 'sip.actor' with the value 'principal' along with the feature tag 'sip.automata' PoCV2.0	6.1.3.3.1 6.1.3.3.2	POC_CP-PBO-C-005-O
POC_CP-PBO-C-008-O	PoC Session decline with forward to UE PoC Box PoCV2.0	6.2.3.1	

POC_CP-PBO-C-009-O	UE PoC Box – Invited to PoC Session PoCV2.0	8.1 8.1.1 8.1.2 8.3 8.3.1	
POC_CP-PBO-C-0010-O	UE PoC Box – PoC Session release PoCV2.0	8.3.2	POC_CP-PBO-S-010-O
POC_CP-PBO-C-011-O	Procedures initiated by UE PoC Box – Leaving a PoC Session (on demand case) PoCV2.0	8.3.3	

A.6.2 NW PoC Box (server functionality)

Item	Function	Reference	Requirement
POC_CP-PBO-S-001-O	Network PoC Box – Invited to PoC Session PoCV2.0	8.1 8.1.1 8.1.2 8.1.3 8.2.1	POC_CP-PBO-S-009-O
POC_CP-PBO-S-002-O	Network PoC Box – PoC Session release PoCV2.0	8.2.2	
POC_CP-PBO-S-003-O	Procedures initiated by NW PoC Box – Leaving a PoC Session (on demand case) PoCV2.0	8.2.3	POC_CP-PBO-S-003-O
POC_CP-PBO-S-004-O	Network PoC Box – Acceptance of the PoC Session invitation initiated by the Inviting PoC Client compliant only to the OMA PoC version 1.0 specification PoCV2.0	8.1.3.1	

A.6.3 PoC Server

Item	Function	Reference	Requirement
POC_CP-PBO-S-004-O	Reject PoC Box from entering a Chat PoC Group Session PoCV2.0	7.2.1.1b	
POC_CP-PBO-S-005-O	Controlling PoC Server: PoC Session Initiation procedures for PoC Box	7.2.2.2.	

	PoCV2.0		
POC_CP-PBO-S-006-O	Participating Poc Server: PoC Session initiation procedures for PoC Box PoCV2.0	7.3.2.2	
POC_CP-PBO-S-007-O	Forward Invitation to a Poc Box: Determination of routing to a PoC Box upon an incoming invitation PoCV2.0	7.3.2.2.5 7.3.2.2.5.1	POC_CP-PBO-S-005-O AND POC_CP-PBO-S-006- O
POC_CP-PBO-S-008-O	Forward Invitation to a PoC Box: Determination of routing to a NW PoC Box upon failure to receive a valid SIP2xx response PoCV2.0	7.3.2.2.5 7.3.2.2.5.2	POC_CP-PBO-S-011-O
POC_CP-PBO-S-009-O	Forward Invitation to a PoC Box: Forward Invitation to a NW PoC Box: PoCV2.0	7.3.2.2.5 7.3.2.2.5.3	POC_CP-PBO-S-007-O OR POC_CP-PBO-S-008-O
POC_CP-PBO-S-010-O	Forward Invitation to a PoC Box: Forward Invitation to a UE PoC Box: PoCV2.0	7.3.2.2.5 7.3.2.2.5.4	POC_CP-PBO-S-007-O
POC_CP-PBO-S-011-O	Acceptance procedures for "PoC Box use" PoC Service Setting. PoCV2.0	7.3.1.14	
POC_CP-PBO-S-012-O	Forward Invitation to a PoC Box: Forward Invitation from Inviting PoC Client compliant only to the OMA PoC version 1.0 specification to a NW PoC Box: PoCV2.0	7.3.2.1 7.3.2.2.5.3	POC_CP-PBO-S-009-O
POC_CP-PBO-S-013-O	Participating PoC Function: PoC Server indicates the anonymity of Invited PoC User(s) in the invitation to Ad-hoc PoC Group Session and 1-1 PoC Session; Forwarding the invitation to a UE PoC Box PoCV2.0	7.3.1.1 7.3.2.2.5.4	
POC_CP-PBO-S-014-O	Including a Warning header with appropriate warning text in the generated error response	8.1.1 5.6	

	PoCV2.0		
--	---------	--	--

A.7 PoC Dispatcher (DIS)

A.7.1 PoC Client

Item	Function	Reference	Requirement
POC_CP-DIS-C-001-O	Register with PoC Dispatcher feature tag PoCV2.0	6.1.1.1	POC_CP-REG-C-002-O OR POC_CP-REG-C-003-O
POC_CP-DIS-C-002-O	PoC Client On-demand Session establishment: Initiation of Dispatch PoC Session PoCV2.0	6.1.3.3.2.1	
POC_CP-DIS-C-003-O	PoC Client Pre-established Session: Initiation of Dispatch PoC Session PoCV2.0	6.1.3.2.1 6.1.3.2.3.1	POC_CP-SJR-C-019-O
POC_CP-DIS-C-004-O	PoC Client acting as PoC Dispatcher transferring Dispatcher Role PoCV2.0	6.1.14	
POC_CP-DIS-C-005-O	PoC Dispatcher or PoC Fleet Member invited to a Dispatch PoC Session in case of Automatic Answer Mode PoCV2.0	6.2.1.2	
POC_CP-DIS-C-006-O	PoC Dispatcher or PoC Fleet Member invited to a Dispatch PoC Session in case of Manual Answer Mode PoCV2.0	6.2.1.3	
POC_CP-DIS-C-007-O	PoC Dispatcher expels another Participant(s) from a Dispatch PoC Session PoCV2.0	6.1.13	

A.7.2 PoC Server

Item	Function	Reference	Requirement
POC_CP-DIS-S-001-O	PoC Server - PoC Dispatcher role transfer request PoCV2.0	7.2.1.24	
POC_CP-DIS-S-002-O	Requests terminated by the Controlling PoC Function: PoC Session setup request	7.2.1.3.1 7.2.1.3.2 5.6	

	from PoC Dispatcher PoCV2.0		
POC_CP-DIS-S-003-O	Requests terminated by the Controlling PoC Function: Session setup request from PoC Fleet member PoCV2.0	7.2.1.3.1 7.2.1.3.3 5.6	
POC_CP-DIS-S-004-O	Requests initiated by the Controlling PoC Function: PoC Session invitation request as Dispatch PoC Session PoCV2.0	7.2.2.2 7.2.1.3.1 7.2.1.3.2 7.2.1.3.3 7.2.1.24	
POC_CP-DIS-S-005-O	Requests received by the Controlling PoC Function: Rejoining a Dispatch PoC Session PoCV2.0	7.2.1.4 5.6 5.8 5.8.1 5.8.2	
POC_CP-DIS-S-006-O	Participating PoC Server: PoC Session initiation procedures: Automatic Answer Mode, Pre-established Session for Dispatch PoC Session PoCV2.0	7.3.1.1 7.3.1.2 7.3.2.2.2	
Dispatch PoC Session Policy Control Procedures			
POC_CP-DIS-S-007-O	PoC Session initiation policy for Dispatch PoC Session for PoC Dispatcher PoCV2.0	7.2.1.14.2	
POC_CP-DIS-S-008-O	PoC Session initiation policy for Dispatch PoC Session for PoC Fleet Member PoCV2.0	7.2.1.14.3	
POC_CP-DIS-S-009-O	PoC Dispatcher role transfer policy PoCV2.0	7.2.1.19	

A.8 Quality of Experience (QOE)

A.8.1 PoC Client

Item	Function	Reference	Requirement
POC_CP-QOE-C-001-O	PoC Client informs PoC Server (Controlling PoC Function) about achieved Local QoE profile when it is not able to achieve the	6.2.1.2, 6.2.1.3 5.8	POC_CP-SJR-C-006-M OR POC_CP-SJR-C-019-O

	negotiated Local QoE profile PoCV2.0		
POC_CP-QOE-C-002-O	Inviting PoC Client - Generating PoC Session establishment requests respecting QoE profiles. PoCV2.0	6.1.3.1 6.1.3.2 6.1.3.3	POC_CP-SJR-C-006-M OR POC_CP-SJR-C-019-O
POC_CP-QOE-C-003-M	PoC Client is provisioned via DM with the authorized QoE profiles and the associated QoS parameters. PoCV2.0	B.1, B.3	
POC_CP-QOE-C-004-O	Invited PoC Client – Generating Session establishment responses respecting QoE Profiles.	6.2.1.1a 6.2.1.2 6.2.1.3	POC_CP-SJR-C-027-O OR POC_CP-SJR-C-028-O

A.8.2 PoC Server

Item	Function	Reference	Requirement
POC_CP-QOE -S-001-O	Participating PoC Function – processing requests initiated by served user: Respond to Pre-established Session initiation requests respecting QoE Profiles PoCV2.0	7.3.1.2 e.3.2 5.8 5.8.1	POC_CP-SJR-S-006-O
POC_CP-QOE -S-002-O	Participating PoC Function – processing requests initiated by served user: Pre-established Session modification request to change media capabilities while not in a PoC Session respecting QoE Profiles PoCV2.0	7.3.1.3 E.3.2 5.8 5.8.1	POC_CP-SJR-S-006-O AND POC_CP-SJR-S-009- O
POC_CP-QOE -S-003-M	Participating PoC Function – processing requests initiated by served user: PoC Session initiation using On-demand Session respecting QoE Profiles PoCV2.0	7.3.1.4 E.3.2 5.8 5.8.1	
POC_CP-QOE -S-004-O	Participating PoC Function – processing requests initiated by served user: PoC Session initiation using Pre-established Session respecting QoE Profiles PoCV2.0	7.3.1.5 E.3.2 5.8 5.8.1	POC_CP-SJR-S-006-O

POC_CP-QOE -S-005-M	Participating PoC Function – processing requests initiated by served user: PoC Session modification request during an ongoing PoC Session respecting QoE Profiles PoCV2.0	7.3.1.6 E.3.2 5.8 5.8.1	POC_CP-SRF-S-003-O
POC_CP-QOE -S-006-O	Participating PoC Function – processing requests initiated by served user: SIP SUBSCRIBE requests respecting the use of Resource-Priority header. PoCV2.0	7.3.1.7 E.3.2 5.8 5.8.1	
POC_CP-QOE -S-007-O	Participating PoC Function – processing requests initiated by served user: SIP session release respecting the use of Resource-Priority header. PoCV2.0	7.3.1.10.1 7.3.1.10.2 7.3.1.10.3 E.3.2 5.8 5.8.1	POC_CP-SJR-S-0941-M OR POC_CP-SJR-S-042-O OR POC_CP-SJR-S-043-O
POC_CP-QOE -S-008-O	Participating PoC Function – processing requests initiated by served user: Simultaneous PoC Sessions control procedures respecting the use of Resource-Priority header. PoCV2.0	7.3.1.12.2 7.3.1.12.3 E.3.2, 5.8, 5.8.1	POC_CP-SRF-S-042-O AND POC_CP-SRF-S-043- O OR POC_CP-SRF-S-044- O
POC_CP-QOE -S-009-O	Participating PoC Function – processing requests initiated by served user: PoC Service Setting procedure (processing SIP PUBLISH requests) respecting the use of Resource-Priority header. PoCV2.0	7.3.1.14 E.3.2, 5.8 5.8.1	
POC_CP-QOE -S-010-O	Participating PoC Function – processing requests terminated by served user: SIP BYE request respecting the use of Resource-Priority header. PoCV2.0	7.3.2.6.1 7.3.2.6.2 E.3.2, 5.8 5.8.1	POC_CP-SJR-S-045-M OR POC_CP-SJR-S-046-O OR POC_CP-SJR-S-047-M
POC_CP-QOE -S-011-M	Requests terminated by the Controlling PoC Function: Session setup based on QoE Profiles PoCV2.0	7.2.1.2 7.2.1.3.1 E.3.2 5.8 5.8.1	POC_CP-SJR-S-038-M OR POC_CP-SJR-S-039-O OR POC_CP-SJR-S-040-O

POC_CP-QOE -S-012-M	Requests terminated by the Controlling PoC Function: Adding Participants to PoC Session request respecting QoE Profiles PoCV2.0	7.2.1.8 E.3.2 5.8 5.8.1	POC_CP-SRF-S-011-M
POC_CP-QOE -S-013-O	Requests terminated by the Controlling PoC Function: Leaving PoC Session request using SIP BYE respecting use of Resource-Priority header PoCV2.0	7.2.1.9.1 7.2.1.9.2 7.2.1.9.3 E.3.2 5.8 5.8.1	POC_CP-SJR-S-049-O OR POC_CP-SJR-S-050-O
POC_CP-QOE -S-014-O	Requests terminated by the Controlling PoC Function: PoC Session Participant information requests respecting use of Resource-Priority header PoCV2.0	7.2.1.11 7.2.1.11.1 7.2.1.11.2 E.3.2 5.8 5.8.1	
POC_CP-QOE -S-015-O	Priority and pre-emption: prioritizing of signalling based on QoE Profile use PoCV2.0	5.8.2 5.8.1	
POC_CP-QOE -S-016-M	Requests terminated by the Controlling PoC Function: Re-joining a PoC Session respecting QoE Profiles PoCV2.0	7.2.1.4 5.8 5.8.1	POC_CP-SJR-S-033-M
POC_CP-QOE -S-017-M	Requests terminated by the Controlling PoC Function: joining a Chat PoC Group Session requests respecting QoE Profiles PoCV2.0	7.2.1.5 E.3.2 5.8 5.8.1	POC_CP-SJR-S-035-M

A.9 Full-Duplex Follow On Call (FDC)

A.9.1 PoC Client

Item	Function	Reference	Requirement
POC_CP-FDC-C-001-O	Register with FDCFO feature tag PoCV2.0	6.1.1.1	POC_CP-REG-C-002-O OR POC_CP-REG-C-003-O
POC_CP-FDC-C-002-O	PoC Session initiation with FDCFO feature tag PoCV2.0	6.1.3.1 6.2.1.1	POC_CP-FDC-C-001-O

POC_CP-FDC-C-003-O	PoC Client sending an FDCFO SIP MESSAGE PoCV2.0	6.1.17	POC_CP-FDC-C-002-O
POC_CP-FDC-C-004-O	PoC Client receiving a FDCFO SIP MESSAGE PoCV2.0	6.2.9	POC_CP-FDC-C-002-O
POC_CP-FDC-C-005-O	PoC Client receiving an FDCFO SIP MESSAGE: rejecting the FDCFO request.	6.2.9	POC_CP-FDC-C-004-O
POC_CP-FDC-C-006-O	PoC Client receiving an FDCFO SIP MESSAGE: accepting the FDCFO request.	6.2.9	POC_CP-FDC-C-004-O
POC_CP-FDC-C-007-O	Release PoC Session when FDCFO accepted PoCV2.0	6.2.9 6.1.17	POC_CP-FDC-C-003-O OR POC_CP-FDC-C-006-O

A.9.2 PoC Server

Item	Function	Reference	Requirement
POC_CP-FDC-S-001-O	Controlling PoC Server: FDCFO request procedure PoCV2.0	7.2.1.25 7.2.2.8	
POC_CP-FDC-S-002-O	Controlling PoC Server: Providing the information of FDCFO support at the participating PoC Clients PoCV2.0	7.2.1.11.2	POC_CP-FDC-S-001-O
POC_CP-FDC-S-003-O	Participating PoC Function – processing FDCFO requests initiated by served user: PoC Session initiation or re-join using On-demand Session PoCV2.0	7.3.1.4 E.3.2 5.8 5.8.1	
POC_CP-FDC-S-004-O	Participating PoC Function – processing FDCFO requests initiated by served user: PoC Session initiation using Pre-established Session PoCV2.0	7.3.1.5 E.3.2 5.8 5.8.1	POC_CP-SJR-S-011-O
POC_CP-FDC-S-005-O	Participating PoC Server: FDCFO request procedure PoCV2.0	7.3.1.17 7.3.2.9	
POC_CP-FDC-S-006-O	Participating PoC Server: PoC Session initiation procedures Automatic Answer Mode,	7.3.2.2.1	

	On-demand Session PoCV2.0		
POC_CP-FDC-S-007-O	Participating PoC Server: PoC Session initiation procedures Automatic Answer Mode, Pre-established Session PoCV2.0	7.3.2.2.2	
POC_CP-FDC-S-008-O	Participating PoC Server: PoC Session initiation procedures Manual-AnswerMode, On- demand Session PoCV2.0	7.3.2.2.3	
POC_CP-FDC-S-009-O	Participating PoC Server: PoC Session initiation procedures Manual Answer Mode, Pre-established Session PoCV2.0	7.3.2.2.4	

A.10 Multiple PoC groups (MPG)

A.10.1 PoC Client

Item	Function	Reference	Requirement
POC_CP-MPG-C-001-O	PoC Client initiates Ad- hoc PoC Group Session with multiple PoC Groups; Pre-established Session PoCV2.0	6.1.3.2.2	
POC_CP-MPG-C-002-O	PoC Client initiates Ad- hoc PoC Group with multiple PoC Groups; On-demand Session PoCV2.0	6.1.3.3.1	
POC_CP-MPG-C-003-O	PoC Client to add participants to multiple PoC Group Session PoCV2.0	6.1.7	

A.10.2 PoC Server

Item	Function	Reference	Requirement
POC_CP-MPG-S-001-O	Participating PoC Server: PoC Session invitation request for multiple groups	7.3.2.2.1 7.3.2.2.3 7.3.2.2.4	

	PoCV2.0		
POC_CP-MPG-S-002-O	Removal of participants Pre-established Session for multiple groups PoCV2.0	7.2.1.9.2 7.2.1.9.4	

A.11 Request with Media Content (RMC)

A.11.1 PoC Client

Item	Function	Reference	Requirement
POC_CP-RMC-C-001-O	Setting of "Included Media Content in a Request Support" PoC Service Setting. PoCV2.0	6.1.1.1, 6.1.2	
POC_CP-RMC-C-002-O	Setting of "Referenced Media Content in a Request Support" PoC Service Setting. PoCV2.0	6.1.1.1, 6.1.2	
POC_CP-RMC-C-003-O	Setting of "Text Content in a Request Support" PoC Service Setting. PoCV2.0	6.1.1.1, 6.1.2	

A.11.2 PoC Server

Item	Function	Reference	Requirement
POC_CP-RMC-S-001-O	Acceptance procedures for "Included Media Content in a Request Support" PoC Service Setting. PoCV2.0	7.3.1.14	
POC_CP-RMC-S-002-O	Acceptance procedures for "Referenced Media Content in a Request Support" PoC Service Setting. PoCV2.0	7.3.1.14	
POC_CP-RMC-S-003-O	Acceptance procedures for "Text Content in a Request Support" PoC Service Setting. PoCV2.0	7.3.1.14	
POC_CP-RMC-S-004-O	PoC Session invitation requests on Participating PoC Function for requests terminated by served user for PoC Session invitation	7.3.2.1 7.3.2.2 7.2.1.2	

	with Included Media Content PoCV2.0		
POC_CP-RMC-S-005-O	Requests terminating at Controlling PoC Server: for PoC Session invitations with Included Media Content PoCV2.0	7.2.1.3 7.2.1.3.1 7.2.1.3.2 7.2.1.3.3	

A.12 Operator specified warning message (OWM)

A.12.1 PoC Client

Item	Function	Reference	Requirement
POC_CP-OWM-C-001-O	PoC Client presenting the Warning header to the user (PoC Session initiation) – originating PoC Client PoCV2.0	6.1.3.1 5.6	
POC_CP-OWM-C-002-O	PoC Client indicating the preferred language for warning text PoCV2.0	5.6	

A.12.2 PoC Server

Item	Function	Reference	Requirement
POC_CP-OWM-S-001-O	PoC Server for PoC Session establishment – error detected during determination of PoC Server role: including a Warning header with appropriate warning text in the generated error response PoCV2.0	7.2.1.1b 5.6	
POC_CP-OWM-S-002-O	PoC Server – Controlling PoC Function: including a Warning header with appropriate warning text in the generated error response PoCV2.0	7.2.1.1 7.2.1.2 7.2.1.3.1 7.2.1.3.2 7.2.1.3.3 7.2.1.4 7.2.1.5 7.2.1.8 7.2.1.24 7.2.2.2	

		5.6	
POC_CP-OWM-S-003-O	PoC Server – Participating PoC Function: including a Warning header with appropriate warning text in the generated error response PoCV2.0	7.3.1.2 7.3.1.3 7.3.1.4 7.3.1.5 7.3.1.6 7.3.1.7 7.3.1.14 7.3.2.1 7.3.2.2 7.3.2.2.2 5.6	
POC_CP-OWM-S-004-O	PoC Server: including a text string and translating its explanatory text to the PoC Client's preferred language in a Warning header PoCV2.0	5.6	

A.13 PoC Media Traffic Optimisation (TOP)

A.13.1 PoC Client

n/a

A.13.2 PoC Server

Item	Function	Reference	Requirement
POC_CP-TOP-S-001-O	Controlling PoC Function: PoC Media Traffic Optimisation PoCV2.0	7.2.2.1a 7.2.2.5	
POC_CP-TOP-S-002-O	Participating PoC Function: PoC Media Traffic Optimisation PoCV2.0	7.3.2.1b 7.3.2.1c	

A.14 Simultaneous PoC Sessions (SPS)

A.14.1 PoC Client

Item	Function	Reference	Requirement
POC_CP-SPS-C-001-O PoCV1.0	Originating PoC Client setting session priority indicating with SDP attribute	6.1.12.1	

	PoCV1.0		
POC_CP-SPS-C-002-O	Simultaneous PoC Session control: PoC Client handling for PoC Session locking in a particular PoC Session PoCV1.0	6.1.12.2	
POC_CP-SPS-C-003-O	Terminating PoC Client setting the PoC Session priority in SDP payload PoCV1.0	6.2.7	
POC_CP-SPS-C-004-O	PoC Client handling for PoC Session locking in a particular PoC Session PoCV1.0	6.2.7	

A.14.2 PoC Server

Item	Function	Reference	Requirement
POC_CP-SPS-S-001-O	Participating PoC Function: Simultaneous PoC Sessions control procedures PoCV1.0	7.3.1.12.1	
POC_CP-SPS-S-002-O	Participating PoC Function: Simultaneous PoC Sessions control - session priority requests PoCV1.0	7.3.1.12.2	
POC_CP-SPS-S-003-O	Participating PoC Function: Simultaneous PoC Sessions control - processing session locking requests PoCV1.0	7.3.1.12.3	

A.15 Invited parties identity information (IPI)

A.15.1 PoC Client

Item	Function	Reference	Requirement
POC_CP-IPI-C-001-O	Setting of IPIIM PoC Service Setting. PoCV2.0	6.1.1.1, 6.1.2	
POC_CP-IPI-C-002-O	Inviting PoC User indicating the anonymity of Invited PoC User(s) in the initiation of Ad-hoc PoC Group Session and 1-	6.1.3.2.2	

	1 PoC Session: Pre-established Session PoCV2.0		
POC_CP-IPI-C-003-O	Inviting PoC User indicating the anonymity of Invited PoC User(s) in the initiation of Ad-hoc PoC Group Session and 1-1 PoC Session: On-demand Session PoCV2.0	6.1.3.3.1	
POC_CP-IPI-C-004-O	PoC User indicating the anonymity of added PoC User(s) in adding PoC User(s) to a PoC Session PoC V2.0	6.1.7	
POC_CP-IPI-C-005-O	Invited PoC Client rendering to the Invited PoC User(s) the identities of the Invited PoC User(s) indicated to be shown and the total number of the Invited PoC User(s) whose identities indicated to be hidden in the initiation of Ad-hoc PoC Group Session and 1-1 PoC Session PoC V2.0	6.2.1.1	

A.15.2 PoC Server

Item	Function	Reference	Requirement
POC_CP-IPI-S-001-O	Acceptance procedures for IPIIM PoC Service Setting. PoCV2.0	7.3.1.14	
POC_CP-IPI-S-002-O	Controlling PoC Function: PoC Server indicates the anonymity of Invited PoC User(s) in the establishment of Ad-hoc PoC Group Session and 1-1 PoC Session; PoC Server indicates the anonymity of added and already participating PoC User(s) when adding PoC User(s) to a PoC Session PoCV2.0	7.2.2.2	
POC_CP-IPI-S-003-O	Participating PoC	7.3.1.1	

	Function: PoC Server indicates the anonymity of Invited PoC User(s) in the invitation to Ad-hoc PoC Group Session and 1-1 PoC Session: Automatic-answer using On-demand Session PoCV2.0	7.3.2.2.1	
POC_CP-IPI-S-004-O	Participating PoC Function: PoC Server indicates the anonymity of Invited PoC User(s) in the invitation to Ad-hoc PoC Group Session and 1-1 PoC Session: Manual-answer using On-demand Session PoCV2.0	7.3.1.1 7.3.2.2.3	
POC_CP-IPI-S-005-O	Participating PoC Function: PoC Server indicates the anonymity of Invited PoC User(s) in the invitation to Ad-hoc PoC Group Session and 1-1 PoC Session: Manual-answer using Pre-established Session PoCV2.0	7.3.1.1 7.3.2.2.4	

A.16 Querying for capabilities (CFC)

A.16.1 PoC Client

Item	Function	Reference	Requirement
POC_CP-CFC-C-001-M	Provides the query for the capabilities. PoCV2.0	6.2.10	

A.16.2 UE PoC Box (client functionality)

Item	Function	Reference	Requirement
POC_CP-CFC-C-002-M	Provides the query for the capabilities. PoCV2.0	8.3.4	

A.16.3 NW PoC Box (server functionality)

Item	Function	Reference	Requirement
POC_CP-CFC-C-001-M	Provides the query for the capabilities. PoCV2.0	8.2.4	

A.16.4 PoC Server

Item	Function	Reference	Requirement
POC_CP-CFC-S-002-M	Controlling PoC Function - provides the query for the capabilities. PoCV2.0	7.2.1.26	
POC_CP-CFC-S-003-M	Participating PoC Function – resends the query for capabilities. PoCV2.0	7.3.2.11, 7.3.1.18	

Appendix B. The parameters to be provisioned for PoC service (Normative)

B.1 OMA PoC Device Management general

This Appendix describes the parameters that are needed for initiation of PoC service, as well as continuous provisioning by service provider. These parameters are specified in Client Provisioning Application Characteristics document (AC file) and Device Management Management Object (DM MOs). The bootstrap function specified in [Provisioning Bootstrap] and [OMA DM] SHALL be used to enforce the security of provisioning. Existing parameters in [Provisioning Content] and [OMA DM] are re-used; those without corresponding parameters are defined in present specification and to be registered in OMNA through OMA official registration procedures.

- 1. APPID (Application ID): The application characteristics name for this application, to be used by DM Client to uniquely identify the application.
- 2. NAME: Application name. To be displayed in equipment, it's specific for each service provider.
- 3. PROVIDER-ID: provides an identifier for the application service access point described by an APPLICATION characteristic.
- 4. TO-NAPID: This parameter allows an application to refer to a network access point with a matching NAPID parameter. It is only possible to refer to network access points defined within the same provisioning document.
- 5. TO-APPREF: The TO-APPREF parameter links the APPLICATION characteristics to another secondary APPLICATION characteristic with a matching APPREF parameter.
- 6. Pre-established Session support: A flag to inform whether the PoC Server supports the Pre-established Session functionality
- 7. Support for Simultaneous PoC Sessions: Maximum number of Simultaneous PoC Sessions supported for this PoC User. The value 0 is used to indicate that Simultaneous PoC Sessions are not supported.
- 8. Max Ad-hoc Group size: Maximum number of Participants allowed for an Ad-hoc PoC Group PoC Session.
- 9. Conference-Factory-URI: A SIP URI used for setting up an Ad-hoc PoC Group or 1-1 PoC Session.
- 10. Exploder-URI: A SIP URI used for sending SIP MESSAGE e.g. Group Advertisement to an URI-list.
- 11. Conference-URI Template: A URI template used by the XDM Client to propose a Conference URI when creating a PoC Group document as specified in [XDM-Core] "*Provisioned XDMC Parameters*".

NOTE 1: The Conference-URI Template parameter value is used by the collocated XDM Client when the PoC Client is compliant only to the OMA PoC version 1.0 specification or when the Version number parameter is equal 1.0 or is not present. The Conference-URI Template provisioned by an XDM specific provisioning parameter is used by the collocated XDM Client in other cases.

- 12. T10 (Talk Burst Release) timer: This parameter indicates the value of the T10 (Talk Burst Release) timer in milliseconds
- 13. T11 (Talk Burst Request) timer: This parameter indicates the value of the T11 (Talk Burst Request) timer in milliseconds
- 14. T13 (End of RTP Media) timer: This parameter indicates the value of the T13 (End of RTP Media) timer in milliseconds
- 15. PoC Server Presence support: This parameter indicates the Presence publish capability of the PoC Server, the PoC status on behalf of a PoC Client.

NOTE 2: The parameters 12 - 14 are parameters needed for OMA PoC UP procedures.

- 16. Version number: This parameter indicates the Home PoC Server release number.
- 17. Max size of media content in requests: This parameter gives the total size of media content contained in MIME bodies.
- 18. Max size of text content in requests: This parameter gives the maximum size of text content allowed to be included in the Subject header of the SIP request.

- 19. QoE-Use: This node and the inherited nodes and parameters indicate the supported QoE Profiles according to the PoC User subscription, and the set of QoS Parameters associated to each Media Type, for each QoE Profile.

The parameters from 6 - 15 are defined in the present specification for PoC service. They are to be registered in OMNA.

These parameters SHALL be obtained via the DM-1 reference point, from the data which is provisioned to the DM Client as specified in [Provisioning Content] and [OMA DM].

B.2 OMA PoC Application Characteristics file

OMA PoC has defined a client provisioning file called Application characteristics (AC) file based on [OMA ClientProvisioning]. It MAY be used for initial provisioning of PoC service configuration to the User Equipment.

The file is specified in [OMA-PoC-AC]. Additionally, this file is registered in OMNA at web page:

http://member.openmobilealliance.org/ftp/OPS/Test/test-OMNA-DM_APPID-registry.htm

NOTE: This link needs to be updated after OP/DM WGs finalized the OMNA registration procedure work.

B.3 OMA PoC Device Management Management Object (MO) file

This subclause defines the mobile device Management Object (MO) for OMA PoC. The MO MAY be used for initial provisioning of parameters when the DM Profile is to be used (as specified on [OMA-DM]), and the MO SHOULD be used for later provisioning of parameters according to [OMA-DM], if required by the service provider to update service configurations.

The OMA PoC Management Object consists of relevant parameters required by the [OMA PoC Enabler]. It is compatible with OMA Device Management protocol specification [OMA-DM], and is defined using the OMA DM Device Description Framework as described in [DMTND] and [DMSTDOBJ].

The Management Object Identifier is: org.openmobilealliance/2.0/PoC.

Protocol compatibility: This MO is compatible with OMA DM 1.2.

Management object name: OMA_PoC.

B.3.1 OMA PoC Management Object tree

The Figure 1: The OMA PoC Management Object and the Figure 2: The OMA PoC Management Object - QoE Profiles information show interior nodes and leaf objects defined under the OMA_PoC node:

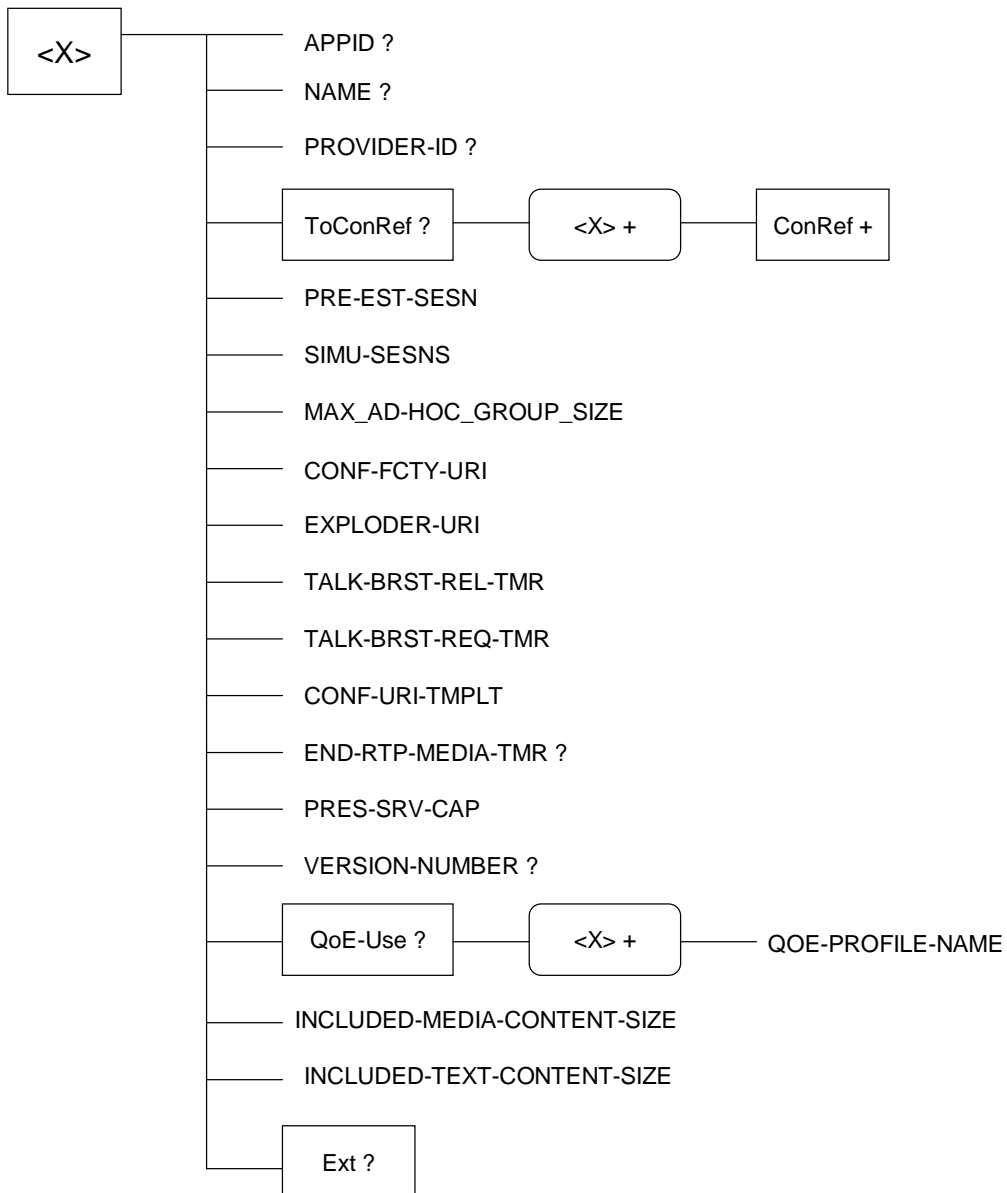

Figure 1: The OMA PoC Management Object

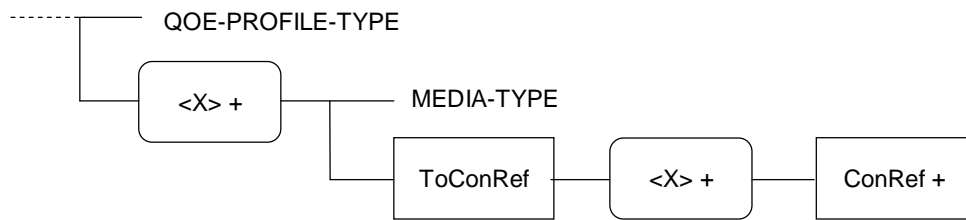

Figure 2: The OMA PoC Management Object – QoE Profiles information

B.3.2 Management Object parameters

This clause describes the parameters for the OMA PoC Management Object.

NOTE 1: The "Occurrence" set to 'One' or 'OneOrMore' indicates that a parameter is mandatory. The "Occurrence" set to 'ZeroOrOne' indicates that the parameter is optional.

1. Node: /<X>

This interior node acts as a placeholder for one or more accounts for a fixed node. The interior node is mandatory if the UE supports OMA PoC.

- Occurrence: OneOrMore
- Format: Node
- Access Types: Get
- Values: xx

2. /<X>/APPID/

The APPID is the identity of the application service available at the described application service access point. The value is expected to be globally unique.

- Occurrence: ZeroOrOne
- Format: chr
- Access Types: Get
- Values: <Globally unique value>

3. /<X>/NAME/

The Name leaf is the application name, which is to be displayed in user's equipment, it's specific for each service provider.

- Occurrence: ZeroOrOne
- Format: chr
- Access Types: Get

- Values: <User displayable name>

4. /<X>/PROVIDER-ID/

This parameter provides an identifier for the application service access point described by an APPLICATION characteristic.

- Occurrence: ZeroOrOne
- Format: chr
- Access Types: Get
- Values: <Provider identifier>

5. /<X>/ToConRef

The ToConRef interior node is used to allow application to refer to a collection of connectivity definitions. Several connectivity parameters may be listed for a give application under this interior node.

- Occurrence: ZeroOrOne
- Format: node
- Access Types: Get
- Values: N/A

6. /<X>/ToConRef/<X>

This run-time node acts as a placeholder for one or more connectivity parameters.

- Occurrence: OneOrMore
- Format: Node
- Access Type: Get
- Value: N/A

7. /<X>/ToConRef/<X>/ConRef

The ConRef indicates the linkage to connectivity parameters. This parameter points to the right connectivity identity, NAP ID and the SIP/IP Core.

- Occurrence: OneOrMore
- Format: chr
- Access Types: Get
- Values: N/A

8. /<X>/PRE-EST-SESN/

This is a flag to inform whether the PoC Server supports the Pre-established Session functionality.

- Occurrence: One
- Format: chr
- Access Types: Get
- Values: 0, 1
 - 0 – Indicates that the home operator's network has NO support for Pre-established Session.

1 – Indicates that the home operator's network has support for Pre-established Session.

9. /<X>/SIMU-SESNS/

This parameter defines the maximum number of Simultaneous PoC Sessions allowed for the PoC User. The value is defined by each service provider.

- Occurrence: One
- Format: chr
- Access Types: Get
- Values: <Integer>

0 – Indicates that the home operator's network has NO support for Simultaneous PoC Sessions.

> 0 – Indicates the maximum number of Simultaneous PoC Sessions supported for the POC User.

10. /<X>/MAX_AD-HOC_ GROUP_SIZE/

This parameter defines the Maximum number of Participants allowed for an Ad-hoc PoC Group Session. The value is defined by each service provider.

- Occurrence: One
- Format: chr
- Access Types: Get
- Values: <Integer>

11. /<X>/CONF-FCTY-URI/

A SIP URI used for setting up an Ad-hoc PoC Group or 1-1 PoC Session.

- Occurrence: One
- Format: chr
- Access Types: Get
- Values: <A SIP URI>

12. /<X>/EXPLODER-URI/

A SIP Exploder-URI used for PoC Client to send SIP MESSAGE, e.g. for Group Advertisement.

- Occurrence: ZeroOrOne
- Format: chr
- Access Types: Get
- Values: <A SIP URI>

13. /<X>/TALK-BRST-REL-TMR/

This parameter indicates the value of the T10 (Talk Burst Release) timer in milliseconds

- Occurrence: One
- Format: chr
- Access Types: Get
- Values: <A time length in millisecond>

14. /<X>/TALK-BRST-REQ-TMR/

This parameter indicates the value of the T11 (Talk Burst Request) timer in milliseconds

- Occurrence: One
- Format: chr
- Access Types: Get
- Values: <A time length in millisecond>

15. /<X>/END-RTP-MEDIA-TMR/

This parameter indicates the value of the T13 (End of RTP Media) timer in milliseconds

- Occurrence: ZeroOrOne
- Format: chr
- Access Types: Get
- Values: <A time length in millisecond>

16. /<X>/CONF-URI-TMPLT/

A URI template used by the XDM Client to propose a Conference URI when creating a PoC Group document as specified in [XDM-Core] "*Provisioned XDMC Parameters*".

NOTE 2: The Conference-URI Template parameter value is used by the collocated XDM Client when the PoC Client is compliant only to the OMA PoC version 1.0 specification or when the Version number parameter is equal 1.0 or is not present. The Conference-URI Template provisioned by an XDM specific provisioning parameter is used by the collocated XDM Client in other cases.

- Occurrence: One
- Format: chr
- Access Types: Get
- Values: <A SIP URI>

17. /<X>/PRES-SRV-CAP/

A binary flag used for PoC Server to indicate the Presence publish capability of the PoC Server, the PoC status on behalf of a PoC Client. The flag must be given in sequence order according to the list of parameters below:

bit1: "Application-specific (PoC) Availability for sessions"

bit2: "Application-specific (PoC) Availability for alerts"

bit3: "Session Participation"

bit 4-8 for future extension.

- Occurrence: One
- Format: bin
- Access Types: Get
- Values: <A binary, b1b2b3xxxxx>

bit 1-3 have 2 values:

0 means no support by the PoC Server and

1 means the support is available.

18. /<X>/VERSION-NUMBER/

This parameter defines the release version of the Home PoC Server.

If the parameter is not present the PoC Client assumes the value indicates PoC 1.0.

- Occurrence: ZeroOrOne
- Format: chr
- Access Types: Get
- Values: 1.0 or higher.

19. /<X>/NW-POC-BOX-URI/

A SIP URI of the NW PoC Box of the PoC Subscriber.

- Occurrence: ZeroOrOne
- Format: chr
- Access Types: Get
- Values: <A SIP URI>

20. /<X>/INCLUDED-MEDIA-CONTENT-SIZE/

This parameter defines the total maximum size of media content included in one or more MIME bodies of a SIP INVITE request or SIP MESSAGE request. The value is defined by each service provider.

If the parameter is not present the PoC Client assumes the value zero.

- Occurrence: ZeroOrOne
- Format: chr
- Access Types: Get
- Values: <Integer>

21. /<X>/INCLUDED-TEXT-CONTENT-SIZE/

This parameter defines the maximum size of text content included in a SIP INVITE request or SIP MESSAGE request. The value is defined by each service provider.

If the parameter is not present the PoC Client assumes the value zero.

- Occurrence: ZeroOrOne
- Format: chr
- Access Types: Get
- Values: <Integer>

22. /<X>/QoE-Use/

This interior node specifies the use of the QoE Profiles and acts as a placeholder of the supported QoE Profiles.

If the parameter is not present, QoE Profiles are not enabled by the Service Provider.

- Occurrence: ZeroOrOne
- Format: Node
- Access Types: Get
- Values: N/A

23. /<X>/QoE-Use/<X>/

This interior node acts as a placeholder for one or more QoE Profiles. It appears once per authorized QoE Profile according to the PoC User subscription.

- Occurrence: OneOrMore
- Format: Node
- Access Types: Get
- Values: N/A

24. /<X>/QoE-Use/<X>/QOE-PROFILE-NAME/

This parameter defines the name of the QoE Profile, as specified in subclause 5.8 "*QoE Profiles*".

- Occurrence: One
- Format: Chr
- Access Types: Get
- Values: Basic, Premium, Professional, Official Government Use

25. /<X>/QoE-Use/<X>/<X>/

This interior node acts as a placeholder for one or more Media Types and the associated QoS parameters. It appears once per Media Type.

- Occurrence: OneOrMore
- Format: Node
- Access Types: Get
- Values: N/A

26. /<X>/QoE-Use/<X>/<X>/MEDIA-TYPE

This parameter defines the Media Type the QoS Parameters will be applied to. The possible values are 'discrete', grouping any the discrete media types, 'speech', 'audio' or 'video'.

- Occurrence: One
- Format: Chr
- Access Types: Get
- Values: audio, speech, video, discrete.

27. /<X>/QoE-Use/<X>/<X>/ToConRef

This interior node acts as a placeholder for one or more references to collection of connectivity definitions for the underlying PS networks.

- Occurrence: One
- Format: Node
- Access Types: Get
- Values: N/A

28. /<X>/QoE-Use/<X>/<X>/ToConRef/<X>

This run-time node acts as a placeholder for one or more references to connectivity parameters.

- Occurrence: OneOrMore
- Format: Node
- Access Type: Get
- Value: N/A

29. /<X>/QoE-Use/<X>/<X>/ToConRef/<X>/ConRef

This ConRef indicates the linkage to connectivity parameters of the underlying PS Access Network. This parameter points to the right Access Network parameters.

- Occurrence: OneOrMore
- Format: Chr
- Access Types: Get
- Values: [OMA-DM-3GPPS-CONNMO], <token>

NOTE 3: Token is used to indicate that any other references can be included. This references will point to Connectivity Management Objects defined by OMA DM WG for any other PS Access Network.

NOTE 4: The values of 3GPP parameters are supposed to be recommended by 3GPP.

30. /<X>/Ext/

The Ext is an interior node for where the vendor specific information about the OMA_PoC MO is being placed (vendor meaning application vendor, device vendor etc.). Usually the vendor extension is identified by vendor specific name under the ext node. The tree structure under the vendor identified is not defined and can therefore include un-standardized sub-tree.

- Occurrence: ZeroOrOne
- Format: node
- Access Types: Get
- Values: N/A

Appendix C. Presence information elements and procedures(Normative)

This Appendix defines the PoC specific presence information elements and the presence procedures, which the PoC functional entities follow in order to perform presence related actions.

C.1 PoC specific presence information elements overview

OMA PoC RD specifies a set of presence elements allowing to express the PoC User's Presence status. This subclause describes these PoC specific presence information elements and how they fit into the overall presence data model as described in [OMA-Pres-Spec].

Table 2 contains the presence element mapping to the respective presence information elements.

Presence element	Presence information elements as specified in [OMA-Pres-Spec]	Description
Willingness for PoC Session Service (see C.1.3)	"Application-specific Willingness for PoC-session"	Indicates whether the PoC User is currently willing to accept new incoming PoC Sessions (Yes/No)
Willingness for PoC Alert Service (see C.1.4)	"Application-specific Willingness for PoC-alert"	Indicates whether the PoC User is currently willing to accept incoming Instant Personal Alerts (Yes/No)
Availability for PoC Session Service (see C.1.1) (Able to accept new incoming PoC Session)	"Application-specific Availability for PoC-session"	Indicates whether the PoC User is able to accept a new incoming PoC Session (True/False)
Availability for PoC Alert Service (see C.1.2) (Able to accept incoming Instant Personal Alerts)	"Application-specific Availability for PoC-alert"	Indicates whether the PoC User is able to accept incoming Instant Personal Alerts (True/False)
PoC Session Participation (see C.1.5) (Currently in at least one PoC Session)	"Session Participation"	Indicates whether the PoC User is currently engaged in one or more PoC Sessions or the PoC User has reached his/her maximum number of Simultaneous PoC Sessions (True/False/Max)
PoC Client Automatic Answer Mode(see C.1.6)	"Session-AnswerMode"	Indicates whether the PoC Client is currently in Automatic Answer Mode or not (automatic/manual).

Table 2: PoC specific Presence states

C.1.1 Availability for PoC Session Service

The "Availability for PoC Session Service" SHALL be mapped to the "Application-specific Availability" presence information element as specified in [OMA-Pres-Spec] pertaining to the "PoC-session" service:

```
<tuple>
    -><status>-><basic>->open/closed
    -><service-description>-><service-id>->org.openmobilealliance:PoC-session
    -><version>->1.0
```

→<registration-state>→active/terminated

→<barring-state>→active/terminated

The "Availability for PoC Session Service" presence information element SHALL be mapped to:

- a mandatory <status> element with <basic> subelement with the value "open"; and,
- an optional <registration-state> element with the value "active"; and,
- an optional <barring-state> element with the value "terminated".

if the presentity is available for incoming PoC Sessions. This happens when

- the PoC User is registered and the valid PoC User's PoC Service Settings are published; and,
- ISB is not activated; and,
- the maximum number of Simultaneous PoC Sessions is not reached.

The "Availability for PoC Session Service" presence information element SHALL be mapped to a mandatory <status> element with a <basic> subelement with the value "closed" and

- an optional <registration-state> element with the value "terminated"; or
- an optional <barring-state> element with the value "active"; or
- an optional <registration-state> element with the value "active" and an optional <barring-state> element with the value "terminated".

if the presentity is unavailable for incoming PoC Sessions. This happens when:

- the PoC User is not registered; or,
- the valid PoC User's PoC Service Settings are not published; or,
- ISB is activated; or
- the maximum number of Simultaneous PoC Sessions is reached.

C.1.2 Availability for PoC Alert Service

The "Availability for PoC Alert Service" SHALL be mapped to the "Application-specific Availability" presence information element as specified in [OMA-Pres-Spec] pertaining to a "PoC-alert" service:

```
<tuple>      →<status>→<basic>→open/closed
              →<service-description>      →<service-id>→org.openmobilealliance:PoC-alert
                                              →<version>→1.0
              →<registration-state>active/terminated
              →<barring-state>→active/terminated
```

The "Availability for PoC Alert Service" presence information element SHALL be mapped to:

- a mandatory <status> element with a <basic> subelement with the value "open"; and
- an optional <registration-state> element with the value "active"; and

- an optional <barring-state> element with the value "terminated"

if the presentity is available for incoming PoC Instant Personal Alerts. This happens when the PoC User's Instant Personal Alerts Barring (IAB) is not activated.

The "Availability for PoC Alert Service" presence information element SHALL be mapped to a mandatory <status> element with a <basic> subelement with the value "closed" and

- an optional <registration-state> element with the value "terminated"; or
- an optional <barring-state> element with the value "active"

if the presentity is unavailable for incoming PoC Instant Personal Alerts. This happens when the PoC User's Instant Personal Alerts Barring (IAB) is activated.

C.1.3 Willingness for PoC Session Service

The "Willingness for PoC Session Service" SHALL be mapped to the "Application-specific Willingness" presence information element as specified in [OMA-Pres-Spec] pertaining to a "PoC-session" service:

```
<tuple>      -><willingness>-><basic>->open/closed
              -><service-description>-><service-id>->org.openmobilealliance:PoC-session
              -><version>->1.0
```

The "Willingness for PoC Session Service" presence information element SHALL be mapped to a <willingness> element with a <basic> subelement with the value "open" if the presentity is willing to accept incoming PoC Session requests. This presence information element MAY be expressed by the Presence Source residing in the same UE as the PoC Client publishing the willingness (see C.3).

The "Willingness for PoC Session Service" presence information element SHALL be mapped to a <willingness> element with a <basic> subelement with the value "closed" if the presentity is not willing to accept incoming PoC Session requests. This presence information element MAY be expressed by the Presence Source residing in the same UE as the PoC Client publishing the unwillingness (see C.3).

C.1.4 Willingness for PoC Alerts Service

The "Willingness for PoC Alert Service" SHALL be mapped to the "Application-specific Willingness" presence information element as specified in [OMA-Pres-Spec] pertaining to a "PoC Alerts" service:

```
<tuple>      -><willingness>-><basic>->open/closed
              -><service-description>-><service-id>->org.openmobilealliance:PoC-alert
              -><version>->1.0
```

The "Willingness for PoC Alert Service" presence information element SHALL be mapped to a <willingness> element with a <basic> sub-element with the value "open" if the presentity is willing to accept incoming Instant Personal Alerts requests. This presence information element MAY be expressed by the Presence Source residing in the same UE as the PoC Client publishing the willingness (see C.3).

The "Willingness for PoC Alert Service" presence information element SHALL be mapped to a <willingness> element with a <basic> subelement with the value "closed" if the presentity is not willing to accept incoming Instant Personal Alerts. This presence information element MAY be expressed by the Presence Source residing in the same UE as the PoC Client publishing the unwillingness (see C.3).

C.1.5 PoC Session Participation

The "PoC Session Participation" SHALL be mapped to the "Session Participation" presence information element as specified in [OMA-Pres-Spec] pertaining to a "PoC Session" service:

```

<tuple >      -><session-participation>-><basic>->open/closed
                -><max>
                -><service-description>-><service-id>->org.openmobilealliance:PoC-session
                -><version>->1.0

```

The "PoC Session Participation" presence information element SHALL be mapped to a <session-participation> element with a <basic> sub-element with the value "open" if the presentity is participating in at least one PoC Session but the maximum number of Simultaneous PoC Sessions has not been reached.

The "PoC Session Participation" presence information element SHALL be mapped to a mandatory <session-participation> element with a <basic> sub-element with the value "open" and an optional <max> sub-element if the presentity has reached the maximum number of Simultaneous PoC Sessions.

The "PoC Session Participation" presence information element including a <session-participation> element with a <basic> sub-element with the value "closed" indicates that the presentity is not participating in any PoC Session.

C.1.6 Automatic Answer Mode

The "PoC Client Automatic Answer Mode" SHALL be mapped to the "Session-AnswerMode" presence information element as specified in [XDM-Pres-EXT] pertaining to a "PoC Session" service:

```

<tuple>        -><session-answermode>-><automatic>/<manual>
                -><service-description>-><service-id>->org.openmobilealliance:PoC-session
                -><version>->1.0

```

The "PoC Client Automatic Answer Mode" presence information element SHALL be mapped to a <session-answermode> element with the element <automatic> to indicate automatic answer mode. This presence information element MAY be expressed by the Presence Source residing in the PoC Server based on the value received in the PoC Service Settings (see subclause C.2.1.4 "Automatic Answer-mode").

The "PoC Client Automatic Answer Mode" presence information element SHALL be mapped to a <session-answermode> element with the element <manual> to indicate manual answer mode. This presence information element MAY be expressed by the Presence Source residing in the PoC Server based on the value received in the PoC Service Settings (see subclause C.2.1.4 "Automatic Answer-mode").

The Presence Authorization Rules SHOULD be set appropriately by the Presentity to provide a tuple that represents the dynamic status of the Answer Mode Indication of the PoC Client only to those watchers authorized by the <allow-auto-answermode> action as described in [OMA-PoC-Document-Mgmt]. For those watchers not authorized by the <allow-auto-answermode> action as described in [OMA-PoC-Document-Mgmt], a tuple that represents the polite blocking status of the Answer Mode Indication of the PoC Client SHOULD be provided

C.2 PoC Server Procedures

This subclause outlines the mapping between PoC procedures and the presence information elements as given in subclause C.1.

If the PoC Server performing the Participating PoC Function in the PoC User's Home PoC Network supports publishing Presence Information on behalf of the PoC Client, the PoC Server SHALL publish the presence information elements indicated in the 'PRES-SRV-CAP' provisioning parameter sent to the PoC Client (see Appendix B).

Table 3 defines the changes of the presence information elements, as specified in [OMA-Pres-Spec], which the PoC Server may publish as a result of the PoC procedures.

PoC procedure	Presence information elements as specified in [OMA-Pres-Spec]	Presence information element value
General Procedures		
De-registration or the PoC Service Setting expiration or removal procedures	"Application-specific Availability for PoC-session"	- basic: closed (mandatory) - registration-state: terminated (optional) - barring-state: terminated (optional)
	"Application-specific Availability for PoC-alert"	- basic: closed (mandatory) - registration-state: terminated (optional) - barring-state: terminated (optional)
IAB activated	"Application-specific Availability for PoC-alert"	- basic: closed (mandatory) - registration-state: active (optional) - barring-state: active (optional)
IAB de-activated	"Application-specific Availability for PoC-alert"	- basic: open (mandatory) - registration-state: active (optional) - barring-state: terminated (optional)
ISB de-activated	"Application-specific Availability for PoC-session"	- basic: open (mandatory) - barring-state: terminated (optional)
ISB activated	"Application-specific Availability for PoC-session"	- basic: closed (mandatory) - barring-state: active (optional)
Automatic Answer activated	"Session-AnswerMode"	session-answermode: automatic (optional)

Automatic Answer de-activated	"Session-AnswerMode"	session-answermode: manual (optional)
-------------------------------	----------------------	--

Table 3: Definition of changes of presence attributes depending on PoC procedure

C.2.1 Acting as a Presence Source

The PoC Server MAY act as a Presence Source as specified in [PoC-AD] and [OMA-Pres-Spec] and publish certain sets of presence information on behalf of the PoC Client.

The PoC Server MAY refresh the published presence information as defined in [OMA-Pres-Spec] until the PoC Server becomes aware of PoC client de-registration state or until the PoC Service Setting expiration or removal.

All the following procedures SHALL apply when the PoC Server acts as a Presence Source and supports the publication of presence information elements as specified in Table 3.

When the SIP/IP Core corresponds with 3GPP/3GPP2 IMS, the PoC Server SHALL use the procedures of "*AS acting as originating User Agent*" defined in [TS24.229] / [3GPP2 X.S0013.4] section 5.7.3, when acting as a Presence Source.

C.2.1.1 PoC registration and de-registration

There is no action defined for the PoC Server when a PoC User registers to the PoC Service in the context of this Appendix.

Upon accepting a de-registration request from a PoC User as specified in subclause 6.1.1.3 "*PoC service de-registration*" MAY act as a Presence Source. In that case, the PoC Server SHALL perform the publication of Presence information as defined in [OMA-Pres-Spec] "*Publication of presence information*". The PoC Server:

- SHALL set the value of the "Availability for PoC Session Service" presence information element to unavailable (as defined in subclause C.1.1 "*Availability for PoC Session Service*" and Table 3)
- SHALL set the "Availability for PoC Alert Service" presence information element to unavailable (as defined in subclause C.1.2 "*Availability for PoC Alert Service*" and Table 3);
- SHALL set the <entity> element of Presence information document as defined in [OMA-Pres-Spec] to the value of the authenticated identity of the PoC User that has de-registered from the PoC service (e.g. to the value of the P-Asserted-Identity header field of the SIP REGISTER request); and,
- MAY set the "PoC Session participation" presence information element to closed (as defined in subclause C.1.5 "*PoC Session Participation*" and Table 3)

NOTE 2: Other Presence information elements might be published with the appropriate values at the same time.

NOTE 3: It is beyond the scope of the present specification to determine how the PoC Server becomes aware of registration/ de-registration state.

C.2.1.2 Incoming PoC Session Barring (ISB)

Upon accepting a request from a PoC User to activate Incoming PoC Session Barring (ISB) as specified in subclause 6.1.2 "*PoC Service Settings procedure*" the PoC Server MAY act as a Presence Source. In that case, the PoC Server SHALL perform the publication of presence information as specified in [OMA-Pres-Spec] "*Publication of presence information*". The PoC Server:

- SHALL set the value of "Availability for PoC Session Service" presence information element to unavailable (as specified in C.1.1 "*Availability for PoC Session Service*" and Table 3);
- SHALL set the <entity> element of the presence information document as specified in [OMA-Pres-Spec] to the value of the authenticated identity of the PoC User publishing the ISB (e.g. to the value of the P-Asserted-Identity header field of the PUBLISH request);

Upon accepting a request from a PoC User to de-activate Incoming PoC Session Barring (ISB) as specified in subclause 6.1.1.1 "PoC service registration and re-registration" MAY act as a Presence Source. In that case, the PoC Server SHALL perform the publication of presence information as specified in [OMA-Pres-Spec] "Publication of presence information". The PoC Server:

- SHALL set the value of "Availability for PoC Session Service" presence information element to available (as specified in C.1.1 "Availability for PoC Session Service" and Table 3);
- SHALL set the <entity> element of the presence information document as specified in [OMA-Pres-Spec] to the value of the authenticated identity of the PoC User publishing the ISB (e.g. to the value of the P-Asserted-Identity header field of the PUBLISH request);

C.2.1.3 Incoming Instant Personal Alert Barring (IAB)

Upon accepting a request from a PoC User to activate Incoming Instant Personal Alert Barring (IAB) the PoC Server MAY act as a presence source. In that case, the PoC Server SHALL perform the publication of presence information as defined in [OMA-Pres-Spec] "Publication of presence information". The PoC Server:

- SHALL set the value of "Availability for PoC Alert Service" presence information element to unavailable (as specified in C.1.2 "Availability for PoC Alert Service" and Table 3);
- SHALL set the <entity> element of presence information document as defined in [OMA-Pres-Spec] to the value of the authenticated identity of the PoC User publishing the IAB (e.g. to the value of the P-Asserted-Identity header field of the PUBLISH request);

Upon accepting a request from a PoC User to de-activate Incoming Personal Alerts Barring (IAB) and acting as a presence source, the PoC Server SHALL perform the publication of Presence information as defined in [OMA-Pres-Spec] section 5.1.1. The PoC Server:

- SHALL set the value of "Availability for PoC Alert Service" presence information element to available (as specified in C.1.2 "Availability for PoC Alert Service" and Table 3);
- SHALL set the <entity> element of presence information document as defined in [OMA-Pres-Spec] to the value of the authenticated identity of the PoC User publishing the IAB (e.g. to the value of the P-Asserted-Identity header field of the PUBLISH request).

C.2.1.4 Automatic Answer-mode

If the PoC Server supports publishing the "PoC Client Automatic Answer Mode" the PoC Server SHALL act as a Presence Source and publish two tuples for the "PoC Client Automatic Answer Mode". One tuple represents the dynamic status of the Answer Mode Indication of the PoC Client and the other tuple represents the polite blocking status of the Answer Mode Indication of the PoC Client and has the <Session-AnswerMode> element always with the value "manual".

The tuple that represents the dynamic status of the Answer Mode Indication of the PoC Client SHALL contain a <class> element containing the value "org.openmobilealliance:PoC-answer-mode-dynamic-status".

The tuple that represents the polite blocking status of the Answer Mode of the PoC Client SHALL contain a <class> element containing the value "org.openmobilealliance:PoC-answer-mode-polite-blocking-status".

Upon accepting an indication from a PoC Client that the Answer-Mode Indication of the PoC Client is Auto-Answer as specified in subclause 6.1.2 "PoC Service Settings procedure" the PoC Server MAY act as a Presence Source. In that case, the PoC Server SHALL perform the publication of presence information as specified in [OMA-Pres-Spec] "Publication of presence information". The PoC Server:

- SHOULD set the value of "Automatic Answer-Mode" presence information element to "automatic" (as specified in C.1.6 "Automatic Answer-Mode" and Table 2) for the tuple representing the dynamic status of the Answer Mode Indication of the PoC Client;
- SHOULD set the value of "Automatic Answer-Mode" presence information element to "manual" (as specified in C.1.6 "Automatic Answer-Mode" and Table 2) for the tuple representing the polite blocking status of the Answer Mode Indication of the PoC Client;

- SHOULD set the <entity> element of the presence information document as specified in [OMA-Pres-Spec] to the value of the authenticated identity of the PoC User publishing the Answer-Mode (e.g. to the value of the P-Asserted-Identity header field of the PUBLISH request);

Upon accepting an indication from a PoC Client that the Answer-Mode Indication of the PoC Client is Manual-Answer as specified in subclause 6.1.2 "*PoC Service Settings procedure*" the PoC Server MAY act as a Presence Source. In that case, the PoC Server SHALL perform the publication of presence information as specified in [OMA-Pres-Spec] "*Publication of presence information*". The PoC Server:

- SHOULD set the value of "Automatic Answer-Mode" presence information element to "manual" (as specified in C.1.6 "*Automatic Answer-Mode*" and Table 2) for the tuple representing the dynamic status of the Answer Mode Indication of the PoC Client;
- SHOULD set the value of "Automatic Answer-Mode" presence information element to "manual" (as specified in C.1.6 "*Automatic Answer-Mode*" and Table 2) for the tuple representing the polite blocking status of the Answer Mode Indication of the PoC Client;
- SHOULD set the <entity> element of the presence information document as specified in [OMA-Pres-Spec] to the value of the authenticated identity of the PoC User publishing the Answer-Mode (e.g. to the value of the P-Asserted-Identity header field of the PUBLISH request).

C.2.1.5 PoC Service Settings expiration or removal procedure

Upon receiving the PoC Service Settings of a PoC User as specified in the subclause 7.3.1.14 "*PoC Service Setting procedure*" with the expiration value equal to 0 or when PoC Service Settings expires and if the PoC Server is acting as the Presence Source for the PoC User, the PoC Server:

- SHALL set the value of the "Availability for PoC Session Service" presence information element to unavailable (as defined in subclause C.1.1 "*Availability for PoC Session Service*" and Table 3)
- SHALL set the "Availability for PoC Alert Service" presence information element to unavailable (as defined in subclause C.1.2 "*Availability for PoC Alert Service*" and Table 3);
- SHALL set the <entity> element of Presence information document as defined in [OMA-Pres-Spec] to the value of the authenticated identity of the PoC User (e.g. to the value of the P-Asserted-Identity header field of the SIP PUBLISH request); and,
- MAY set the "PoC Session participation" presence information element to closed (as defined in subclause C.1.5 "*PoC Session Participation*" and Table 3)

NOTE: Other Presence information elements might be published with the appropriate values at the same time.

C.2.2 Acting as watcher

The PoC Server MAY act as a watcher as specified in [PoC-AD] and [OMA-Pres-Spec] and according to the setting of the provisioning parameter 'PRES-SRV-CAP' as specified in subclause B.3.2 "*Management Object parameters*". When the SIP/IP Core corresponds with 3GPP/3GPP2 IMS, the PoC Server SHALL use the procedures of "*AS acting as originating User Agent*" specified in [TS24.229] / [3GPP2 X.S0013.4] section 5.7.3.

The exact procedures determining the behaviour of the PoC Server acting as watcher is beyond the scope of the present specification.

C.3 PoC Client

The PoC Client SHOULD collaborate with the Presence Source and watcher entities when residing in the same UE.

The Presence Source residing in the same UE with the PoC Client, MAY publish the presence information for the elements specified in subclauses C.1.3 "*Willingness for PoC Session Service*" and C.1.4 "*Willingness for PoC Alert Service*", and additionally any other presence information element described in [OMA-Pres-Spec].

The Presence Source residing in the same UE as the PoC Client SHOULD publish the presence information elements according to setting of the provisioning parameter 'PRES-SRV-CAP' as specified in subclause B.3.2 "*Management Object parameters*".

The exact procedures determining the collaboration between the PoC Client, the watcher and the Presence Source in the UE are beyond the scope of the present specification.

C.4 PoC specific presence values

The OMNA SHALL register the following new values for the <service-description> presence information element defined in [OMA-Pres-Spec] related to PoC:

<service-id>: org.openmobilealliance:PoC-session, org.openmobilealliance:PoC-alert

<version>: 1.0

Appendix D. Initial Filter Criteria (Informative)

D.1 General

The 3GPP/3GPP2 IMS uses initial Filter Criteria to determine the routing of initial SIP requests between the home network SIP/IP Core and Application Servers such as the PoC Server. The initial Filter Criteria is part of the PoC User subscription information and represent the provisioned subscription of a PoC User to an application(s). This clause is only informative because it is likely that the PoC service needs to be integrated with other SIP based services potentially hosted on different platforms from the PoC Server. In this case the initial Filter Criteria for the PoC service needs to be integrated with initial Filter Criteria for the other applications.

If some other SIP/IP Core than 3GPP/3GPP2 IMS that does not use initial Filter Criteria is used to deploy the PoC service then the logic identified here needs to be implemented by the SIP/IP Core to route the PoC related SIP requests to the PoC Server.

Further details on initial Filter Criteria are specified in [TS23.218] and [TS29.228].

D.2 Originating Filter Criteria

NOTE: Originating Filter Criteria is indexed on the P-Asserted-Identity header.

CASE method="INVITE" AND header="Accept-Contact" = "+g.poc.talkburst"

THEN: ROUTE request to the specified PoC Server Originating Port Address.

CASE method="OPTIONS" AND header="Accept-Contact" = "+g.poc.talkburst"

THEN: ROUTE request to the specified PoC Server Originating Port Address.

CASE method="MESSAGE" AND header="Accept-Contact" = "+g.poc.talkburst"

THEN: ROUTE request to the specified PoC Server Originating Port Address.

CASE method="MESSAGE" AND header="Accept-Contact" = "+g.poc.groupad"

THEN: ROUTE request to the specified PoC Server Originating Port Address.

CASE method="MESSAGE" AND header="Accept-Contact" = "+g.poc.discretemedia"

THEN: ROUTE request to the specified PoC Server Originating Port Address.

CASE method="MESSAGE" AND header="Accept-Contact" = "+g.poc.fdcfo"

THEN: ROUTE request to the specified PoC Server Originating Port Address.

CASE method="SUBSCRIBE" AND header="Accept-Contact" = "+g.poc.talkburst"

THEN: ROUTE request to the specified PoC Server Originating Port Address.

CASE method="PUBLISH" AND header="Accept-Contact" = "+g.poc.talkburst"

THEN: ROUTE request to the specified PoC Server Originating Port Address.

CASE method="REFER" AND header="Accept-Contact" = "+g.poc.talkburst"

THEN: ROUTE request to the specified PoC Server Originating Port Address.

CASE method="REGISTER" AND header="Contact" = "+g.poc.talkburst"

THEN: ROUTE request to the specified PoC Server Originating Port Address.

CASE method="REGISTER" AND header="Contact" = "+g.poc.groupad"

THEN: ROUTE request to the specified PoC Server Originating Port Address.

D.3 Terminating Filter Criteria

D.3.1 Terminating Filter Criteria for PoC Address when a PoC Client is registered

NOTE: Terminating Filter Criteria is indexed based on the Request-URI.

The following terminating filter criteria apply when the Request-URI contains the PoC Address and a PoC Client identified by the Request-URI is registered (SessionCase = "TERMINATING_REGISTERED").

CASE method="INVITE" AND header="Accept-Contact" = "+g.poc.talkburst"

THEN: ROUTE request to the specified PoC Server Terminating Port Address

CASE method="OPTIONS" AND header="Accept-Contact" = "+g.poc.talkburst"

THEN: ROUTE request to the specified PoC Server Terminating Port Address

CASE method="MESSAGE" AND header="Accept-Contact" = "+g.poc.talkburst"

THEN: ROUTE request to the specified PoC Server Terminating Port Address

CASE method="MESSAGE" AND header="Accept-Contact" = "+g.poc.groupad"

THEN: ROUTE request to the specified PoC Server Terminating Port Address

CASE method="MESSAGE" AND header="Accept-Contact" = "+g.poc.discretemedia"

THEN: ROUTE request to the specified PoC Server Terminating Port Address

CASE method="MESSAGE" AND header="Accept-Contact" = "+g.poc.fdco"

THEN: ROUTE request to the specified PoC Server Terminating Port Address

D.3.2 Terminating Filter Criteria for PoC Address when no PoC Client is registered

NOTE: Terminating Filter Criteria is indexed based on the Request-URI.

The following terminating filter criteria apply when the Request-URI contains the PoC Address and no PoC Client identified by the Request-URI is registered (SessionCase = "TERMINATING_UNREGISTERED").

CASE method="INVITE" AND header="Accept-Contact" = "+g.poc.talkburst"

THEN: ROUTE request to the specified PoC Server Terminating Port Address

CASE method="OPTIONS" AND header="Accept-Contact" = "+g.poc.talkburst"

THEN: ROUTE request to the specified PoC Server Terminating Port Address

D.3.3 Terminating Filter Criteria for PoC Group Identity or PoC Session Identity

NOTE 1: Terminating Filter Criteria is indexed based on the Request-URI.

The following terminating filter criteria apply when the Request-URI contains the PoC Group Identity or the PoC Session Identity and the SIP/IP Core uses the initial Filter Criteria to determine the routing of the SIP request.

NOTE 2: Depending on the Request-URI structure, the SIP/IP Core can route the SIP request to the PoC Server without considering the initial Filter Criteria.

CASE method="INVITE" AND header="Accept-Contact" = "+g.poc.talkburst"

THEN: ROUTE request to the specified PoC Server Terminating Port Address

CASE method="OPTIONS" AND header="Accept-Contact" = "+g.poc.talkburst"

THEN: ROUTE request to the specified PoC Server Terminating Port Address

CASE method="MESSAGE" AND header="Accept-Contact" = "+g.poc.groupad"

THEN: ROUTE request to the specified PoC Server Terminating Port Address

CASE method="MESSAGE" AND header="Accept-Contact" = "+g.poc.discretemedia"

THEN: ROUTE request to the specified PoC Server Terminating Port Address

CASE method="MESSAGE" AND header="Accept-Contact" = "+g.poc.fdcfo"

THEN: ROUTE request to the specified PoC Server Terminating Port Address

CASE method="SUBSCRIBE" AND header="Accept-Contact" = "+g.poc.talkburst"

THEN: ROUTE request to the specified PoC Server Terminating Port Address

Appendix E. Documentation of SIP, SDP and XML extensions(Informative)

E.1 PoC content types

This subclause describes the PoC specific content types.

E.1.1 Group Advertisement

The Group Advertisement document is described in [OMA-PoC-Documents-Mgmt] "*Group Advertisement*" and "*PoC extensions to Group Advertisement*".

E.1.2 Participant information indications

The participant information indications extend the XML schema specified in [RFC4575].

The following PoC attributes are defined:

- The "LocalQoE" attribute appears in the <endpoint> element of participant notifications, and indicates the negotiated Local QoE Profile for the user for the PoC Session. The "LocalQoE" attribute can take the value of 'Basic', 'Premium', 'Professional', or the optional 'Official Government Use'.
- The "FDCFOSupported" attribute appears in the <endpoint> element of participant notifications, and indicates whether or not the PoC Client has indicated support for the "FDCFO Proceed" feature. The "FDCFOSupported" attribute may take the value of either "true" or "false".
- The "anonymous-id" attribute appears in the <user> element of participant notifications, and indicates whether the PoC User has requested privacy or not. The "anonymous-id" attribute contains the Anonymous PoC Address of the Participant.

E.1.2.1 Example of the participant information indications

```
<?xml version="1.0" encoding="UTF-8"?>
  <conference-info xmlns="urn:ietf:params:xml:ns:conference-info"
    xmlns:xsi="http://www.w3.org/2001/XMLSchema-instance"
    xmlns:piind="urn:oma:xml:poc:participant-info-ind"
    xsi:schemaLocation="urn:ietf:params:xml:ns:conference-info"
    entity="sip:OMA-Golf-buddies@networkX.net " state="full" version="1">
    <users>
      <user entity="sip:PoC-UserB@networkB.net" state="full" anonymous-
        id="Anonymous-1@anonymous.invalid">
        <display-text>PoC User B</display-text>
        <endpoint entity="sip:Anonymous-1@anonymous.invalid"
          piind:LocalQoE="Basic" piind:FDCFOSupported="true">
          <status>connected</status>
        </endpoint>
      </user>
      <user entity="sip:PoC-UserC@networkC.net" state="full">
```

```

        <display-text>PoC User C</display-text>

        <endpoint entity="sip: PoC-ClientC@networkC.net "
piind:LocalQoE="Premium" piind:FDCFOSupported="false">

            <status>connected</status>

        </endpoint>
    </user>
<users>
</conference-info>

```

E.1.2.2 XML Schema for a participant information indications

The participant information indications SHALL conform to the XML schema described in [OMA-POC-PARTICIPANTINFOIND].

The following XML namespace prefix SHALL be used, when generating participant information indications:

```
xmlns:piind="urn:oma:xml:poc:participant-info-ind"
```

E.1.3 FDCFO Proceed document

E.1.3.1 Structure of a FDCFO Proceed document

A FDCFO document is an XML document that must be well-formed and has to be valid. FDCFO Proceed documents are based on XML 1.0 and uses UTF-8 encoding. This specification makes use of XML namespaces for identifying FDCFO Proceed documents and document fragments. The FDCFO Proceed documents are based on the extended XML schema "urn:ietf:params:xml:ns:resource-lists". The namespace URI for extension elements defined by this specification is a URN, using the namespace identifier 'oma'. This URN is:

```
urn:oma:xml:poc:fdcfo
```

A FDCFO Proceed document begins with the root <resource-list> element as specified in "urn:ietf:params:xml:ns:resource-lists". It consists of single <list> element, which contains list of <entry> elements. The <list> can contain the "name" attribute indicating the name of the full duplex voice call. Each <entry> contains attribute "uri", which contains SIP or TEL URI indicating the full duplex voice call address. The <entry> element can contain <postd> element, which contains a post dial string to be dialed after the full duplex voice call is set up, e.g., a conference call participant code. Multiple <entry> elements can be provided only if they identify the same full duplex voice call.

Usage of <entry-ref>,<external> is not defined for FDCFO document and if included in FDCFO document, they are ignored. Single <list> element can be included in <resource-list>.

The following XML namespace prefix SHALL be used, when generating FDCFO document:

```
xmlns:fdcfo="urn:oma:xml:poc:fdcfo"
```

A FDCFO Proceed document shall be identified with the MIME content type "application/vnd.poc.fdcfo+xml".

E.1.3.2 Example of a FDCFO Proceed XML document

```

<?xml version="1.0" encoding="UTF-8"?>
<resource-lists
  xmlns="urn:ietf:params:xml:ns:resource-lists"
  xmlns:fdcfo="urn:oma:xml:poc:fdcfo"
>

```

```
<list name="My conference">
  <entry uri="sip:myconference@conferencebridge.com" />
  <entry uri="tel:+15555555555">
    <fdcfo:postd>23456#</fdcfo:postd>
  </entry>
</list>
</resource-lists>
```

E.1.3.3 XML Schema for a FDCFO Proceed XML document

The following XML namespace prefix SHALL be used, when generating PoC Service Settings document:

```
xmlns:fdcfo="urn:oma:xml:ns:poc:fdcfo"
```

The Full Duplex Call Follow On proceed postd element SHALL conform to the XML schema described in [OMA-POC-FDCFO].

E.2 PoC feature tags

This subclause describes the PoC feature tags.

E.2.1 Talk Burst

Media feature tag name: g.poc.talkburst.

ASN.1 Identifier: New assignment by IANA.

Summary of the media feature indicated by this tag: This feature tag indicates that the device supports OMA Push to talk over Cellular (PoC) Talk Burst Control.

Values appropriate for use with this feature tag: Boolean.

The feature tag is intended primarily for use in the following applications, protocols, services, or negotiation mechanisms:

This feature tag is most useful in a communications application, for describing the capabilities of a device, such as a phone or PDA.

Examples of typical use: Routing a call to a mobile phone that can support Push to talk over Cellular (PoC) service.

Related standards or documents: OMA-TS-PoC_ControlPlane-V2_0 published at <http://www.openmobilealliance.org/>.

Security Considerations: Security considerations for this media feature tag are discussed in Section 11.1 of [RFC3840].

Name(s) & email address(es) of person(s) to contact for further information:

1. Name : OMA Push to Talk over Cellular (POC) Working Group
2. Email : technical-comments@mail.openmobilealliance.org

Intended usage: Common

Author/Change controller: The OMA PoC specifications are a work item of the OMA Push to Talk over Cellular (POC) Working Group. The Open Mobile Alliance has change control over these specifications, with mailing list address technical-comments@mail.openmobilealliance.org.

E.2.2 Group Advertisement

Media feature tag name: g.poc.groupad.

ASN.1 Identifier: New assignment by IANA.

Summary of the media feature indicated by this tag: This feature tag indicates that the device supports OMA Push to talk over Cellular (PoC) Group Advertisement.

Values appropriate for use with this feature tag: Boolean.

The feature tag is intended primarily for use in the following applications, protocols, services, or negotiation mechanisms:

This feature tag is most useful in a communications application, for describing the capabilities of a device, such as a phone or PDA.

Examples of typical use: Routing a Group Advertisement message to a mobile phone that can support PoC Group Advertisements.

Related standards or documents: OMA-TS-PoC_ControlPlane-V2_0 published at <http://www.openmobilealliance.org/>.

Security Considerations: Security considerations for this media feature tag are discussed in Section 11.1 of [RFC3840].

Name(s) & email address(es) of person(s) to contact for further information:

1. Name : OMA Push to Talk over Cellular (POC) Working Group
2. Email : technical-comments@mail.openmobilealliance.org

Intended usage: Common

Author/Change controller: The OMA PoC specifications are a work item of the OMA Push to Talk over Cellular (POC) Working Group. The Open Mobile Alliance has change control over these specifications, with mailing list address technical-comments@mail.openmobilealliance.org

E.2.3 Discrete Media

Media feature tag name: g.poc.discretemedia.

ASN.1 Identifier: New assignment by IANA.

Summary of the media feature indicated by this tag: This feature tag indicates that the device supports OMA Push to talk over Cellular (PoC) Discrete Media transfer.

Values appropriate for use with this feature tag: Boolean.

The feature tag is intended primarily for use in the following applications, protocols, services, or negotiation mechanisms:

This feature tag is most useful in a communications application, for describing the capabilities of a device, such as a phone or PDA.

Examples of typical use: Routing a Discrete Media message to a mobile phone that can support PoC Discrete Media.

Related standards or documents: OMA-TS-PoC_ControlPlane-V2_0 published at <http://www.openmobilealliance.org/>.

Security Considerations: Security considerations for this media feature tag are discussed in Section 11.1 of [RFC3840].

Name(s) & email address(es) of person(s) to contact for further information:

1. Name : OMA Push to Talk over Cellular (POC) Working Group
2. Email : technical-comments@mail.openmobilealliance.org

Intended usage: Common

Author/Change controller: The OMA PoC specifications are a work item of the OMA Push to Talk over Cellular (POC) Working Group. The Open Mobile Alliance has change control over these specifications, with mailing list address technical-comments@mail.openmobilealliance.org

E.2.4 PoC Dispatcher

Media feature tag name: g.poc.dispatcher.

Summary of the media feature indicated by this tag: This feature tag indicates that the device supports OMA Push to talk over Cellular Dispatcher capabilities.

Values appropriate for use with this feature tag: Boolean.

The feature tag is intended primarily for use in the following applications, protocols, services, or negotiation mechanisms:

This feature tag is most useful in a communications application, for describing the capabilities of a device, such as a phone, PDA or laptop.

Examples of typical use:

Routing a Dispatch PoC Session to a mobile phone that supports PoC Dispatcher capabilities, when the PoC Dispatcher role is required.

Communicating PoC Dispatcher capabilities at Dispatch PoC Session establishment.

Related standards or documents: OMA-TS-PoC_ControlPlane-V2_0 published at <http://www.openmobilealliance.org/>.

Security Considerations: Security considerations for this media feature tag are discussed in Section 11.1 of [RFC3840].

Name(s) & email address(es) of person(s) to contact for further information:

1. Name : OMA Push to Talk over Cellular (POC) Working Group
2. Email : technical-comments@mail.openmobilealliance.org

Intended usage: Common

Author/Change controller: The OMA PoC specifications are a work item of the OMA Push to Talk over Cellular (POC) Working Group. The Open Mobile Alliance has change control over these specifications, with mailing list address technical-comments@mail.openmobilealliance.org

E.2.5 FDCFO Proceed

Media feature tag name: g.poc.fdcfo.

Summary of the media feature indicated by this tag: This SIP feature tag indicates that the PoC Client supports the OMA Push to talk over Cellular FDCFO Proceed feature.

Values appropriate for use with this feature tag: Boolean.

The SIP feature tag is intended primarily for use in the following applications, protocols, services, or negotiation mechanisms:

This feature tag is most useful in a communications application, for describing the capabilities of a device, such as a phone, PDA or laptop.

Examples of typical use:

Routing a FDCFO Proceed SIP MESSAGE request to a mobile phone that supports FDCFO Proceed feature .

Related standards or documents: OMA-TS-PoC_ControlPlane-V2_0 published at <http://www.openmobilealliance.org/>.

Security considerations: Security considerations for this media feature tag are discussed in Section 11.1 of [RFC3840].

Name(s) & email address(es) of person(s) to contact for further information:

1. Name : OMA Push to Talk over Cellular (POC) Working Group
2. Email : technical-comments@mail.openmobilealliance.org

Intended usage: Common

Author/Change controller: The OMA PoC specifications are a work item of the OMA Push to Talk over Cellular (POC) Working Group. The Open Mobile Alliance has change control over these specifications, with mailing list address technical-comments@mail.openmobilealliance.org

E.2.6 PoC Interworking Service

NOTE: The use of the PoC Interworking Service feature tag by the PoC Server (e.g. to be added to charging records) is implementation specific and outside the scope of this specification.

Media feature tag name: g.poc.interworking.

Summary of the media feature indicated by this tag: This SIP feature tag indicates that the network element supports the OMA Push to talk over Cellular (PoC) PoC Interworking Service.

Values appropriate for use with this feature tag: Boolean.

The SIP feature tag is intended primarily for use in the following applications, protocols, services, or negotiation mechanisms:

This feature tag is most useful in a communications application, for describing the capabilities of a network element.

Examples of typical use:

Providing the information about the use of the PoC Interworking Service to the PoC Server to be added to the charging records.

Communicating PoC Interworking Service capabilities at PoC Session establishment involving the PoC Inteworking Function or the PoC Interworking Service

Related standards or documents: OMA-TS-PoC_ControlPlane-V2_0 published at <http://www.openmobilealliance.org/>.

Security considerations: Security considerations for this media feature tag are discussed in Section 11.1 of [RFC3840].

Name(s) & email address(es) of person(s) to contact for further information:

1. Name : OMA Push to Talk over Cellular (POC) Working Group
2. Email : technical-comments@mail.openmobilealliance.org

Intended usage: Common

Author/Change controller: The OMA PoC specifications are a work item of the OMA Push to Talk over Cellular (POC) Working Group. The Open Mobile Alliance has change control over these specifications, with mailing list address technical-comments@mail.openmobilealliance.org

E.3 SDP extensions

E.3.1 Media Burst Control Protocol MIME registration

This MIME registration covers transport over UDP.

Type name: Application

Subtype name: TBCP

Required parameters: None

Optional parameters:

multimedia	This parameter is used to negotiate and indicate that the multimedia MBTCP extensions in addition to those for Talk Burst Control Protocol are used. Permissible values are 0 and 1. If multimedia=1 is present in a SDP offer or a SDP answer this indicates support for receiving the multimedia extensions specified in [OMA-POC-UP]. If multimedia=0 or if the multimedia parameter is not present in a SDP offer or a SDP answer this indicates that only the functionality supported in [OMA-POC-1-UP] is to be used. The SDP answer contains either the value lower or equal to the SDP offer version value, or no multimedia parameter at all. multimedia=0 or no multimedia parameter can be used only when the SDP offer or SDP answer contains one PoC Speech with Talk Burst Control Protocol only.
mbc_scheme	This parameter is used to negotiate and indicate the Media Burst Control Scheme to be used in the PoC Session. Permissible values are an ASCII character string with the maximum length of 12 characters. If the PoC Client supports the Media Burst Control Scheme, the PoC Client can include the mbc_scheme parameter in the SDP offer in PoC Session establishment. If the mbc_scheme parameter is present in a SDP offer from the PoC Client for the PoC Session, the PoC Client is indicating the Media Burst Control Scheme to be used in the PoC Session. If the mbc_scheme parameter is present in a SDP offer or SDP answer from the PoC Server hosting the PoC Session, the PoC Server is indicating usage of the Media Burst Control Scheme in the PoC Session. If the PoC Server supports the Media Burst Control Scheme, the PoC Server can include the mbc_scheme parameter in the SDP answer if the PoC Group definition contains the Media Burst Control Scheme information. The mbc_scheme parameter can only be included if the multimedia parameter is also included with value 1.
queuing:	This parameter is used to negotiate the optional Media Burst Request queuing feature. Permissible values are 0 and 1. If set equal to 1, Media Burst Request queuing operation is supported. If set equal to 0 or if not present, no Media Burst Request queuing operation is employed. If queuing=1 is present in a SDP offer then the offerer is indicating that it supports and is willing to support Media Burst Request queuing operation. The answerer can include the queuing parameter in a SDP answer if it was present in the SDP offer. If the answerer wishes to indicate that it supports and is willing to perform Media Burst Request queuing operation it includes queuing=1 in the SDP answer. If queuing=0 or no queuing parameter is present in the SDP answer then Media Burst Request queuing operations are not to be performed.
tb_priority:	This parameter is used to negotiate that priority levels can be used in Media Burst Request messages and defines the maximum priority that a PoC Client is allowed to specify. The allowed values for tb_priority are: "0" – receive only – the PoC Client is not authorised to request to send Media.

"1" – normal priority – the normal priority for Media Burst Requests from PoC Clients and that is granted to PoC Clients that don't support priority queuing.

"2" – high priority – the PoC Client Media Burst Requests are handled with a higher priority than those of the normal priority level.

"3" – preemptive priority – the PoC Client Media Burst Requests pre-empt those in the queue of all other priority levels and any current speaker of a lower priority level Right to Speak is revoked and the PoC Client is granted the Right to Speak immediately.

The offerer can request priority based queuing operation by including the `tb_priority` parameter in a SDP offer. The answerer can include the `tb_priority` parameter in the SDP answer if it was present in the SDP offer. The answerer may change the value of the `tb_priority` parameter to a lower value but does not increase the value. The only exception to this rule is that priority levels and the `tb_priority` parameter are not supported and the `tb_priority` parameter is not present, Media Burst Request messages from the PoC Client are handled using the normal priority and then the priority level can be effectively promoted from receive only to normal priority.

timestamp:	This parameter is used to negotiate the use of the optional timestamp feature in Media Burst Request messages. Permissible values are 0 and 1. If set equal to 1, then timestamp based queuing is supported and timestamps can be included in the Media Burst Request messages. If set equal to 0 or if not present, timestamp based queuing is not supported. If <code>timestamp=1</code> is present in a SDP offer then the offerer is indicating that it supports and is willing to support timestamp based queuing operation. The answerer can include the timestamp parameter in a SDP answer if it was present in the SDP offer. If the answerer wishes to indicate that it supports and is willing to perform timestamp based queuing operation it includes <code>timestamp=1</code> in the SDP answer. If <code>timestamp=0</code> or no queuing parameter is present in the SDP answer then timestamp based queuing operations are not to be performed and timestamps are not included in Media Burst Request messages. When the timestamp parameter is included in SDP the queuing parameter <code>queuing=1</code> also has to be included.
tb_granted:	This optional parameter is used to negotiate and indicate using SDP that permission to send a Media Burst is implicitly granted to the PoC Client. Permissible values are 0 and 1. If <code>tb_granted=1</code> is present in a SDP offer from the PoC Client the PoC Client is indicating support for receiving an indication of Media Burst granted in the SDP answer. If <code>tb_granted=0</code> or if the <code>tb_granted</code> parameter is not present in a SDP offer from the PoC Client the PoC Client is indicating that it does not support receiving an indication of Media Burst granted in the SDP answer. The PoC Server performing the Controlling PoC Function can include a <code>tb_granted = 1</code> in the SDP answer if <code>tb_granted=1</code> was included in the SDP offer. If the SDP answer contains <code>tb_granted=1</code> , the PoC Client, behaves as if a MBCP Media Burst Granted message had been received. If <code>tb_granted=0</code> or if no <code>tb_granted</code> parameter is present in the SDP answer, the PoC Client behaves as if no MBCP Media Burst Granted message has been received. The PoC Server does not include the <code>tb_granted</code> parameter in a SDP offer and the PoC Client does not include the <code>tb_granted</code> parameter in a SDP answer, however the PoC Server does forward the <code>tb_granted</code> parameter in forwarded requests and responses.
tb_compfactor:	This optional parameter can be used in conjunction with the <code>tb_bufsize</code> parameter. <code>tb_compfactor</code> is used to negotiate and indicate that the PoC Client will use Media Time Compression if the Media data is buffered by the PoC Client before sending it to the PoC Server. Permissible values are the compression factor as a floating number. If <code>tb_compfactor</code> is present in an SDP

offer from the PoC Client it indicates the maximum compression factor the PoC Client is willing to use for buffering into its transmit buffer. The PoC Server can only include the `tb_compfactor` parameter in the SDP answer if a `tb_compfactor` was included in the SDP offer. If the SDP answer contains a `tb_compfactor`, the PoC Client time compresses RTP Media data by the value of the answered `tb_compfactor` into its transmit buffer. If the SDP answer does not contain any `tb_compfactor` parameter, the PoC Client may not time compress RTP Media data. The "`tb_compfactor`" parameter can only be included if the "`multimedia`" parameter with value 1 is also included.

NOTE: The floating number values of `tb_compfactor` are textually represented according to the ISO 6093 standard.

<code>tb_seg_preload:</code>	<p>This optional parameter is used to negotiate and indicate using SDP that the PoC Client has Limited Segment Media Buffer Preload capability. Permissible values are non-negative integers. If <code>tb_seg_preload</code> containing a non zero value is present in a SDP offer from the PoC Client, the PoC Client is indicating support for Limited Segment Media Buffer Preload capability. If <code>tb_seg_preload=0</code> or if the <code>tb_seg_preload</code> parameter is not present in a SDP offer from the PoC Client the PoC Client is indicating that it does not support this.</p> <p>The PoC Server can only include the <code>tb_seg_preload</code> parameter in the SDP answer if <code>tb_seg_preload</code> was included in the SDP offer. If the SDP answer contains a nonzero value of <code>tb_seg_preload</code>, the PoC Client has permission to transmit prior to MBCP Media Burst Granted message reception a segment of RTP Media limited to the value of <code>tb_seg_preload</code> contained in the SDP answer in octets. If the SDP answer contains a value of <code>tb_seg_preload=0</code> or no <code>tb_seg_preload</code> parameter, the PoC Client does not use the Limited Segment Media Buffer Preload. The "<code>tb_seg_preload</code>" parameter can only be included if the "<code>multimedia</code>" parameter with value 1 is also included.</p>
<code>tb_txbufsize:</code>	<p>This optional parameter is used to negotiate and indicate using SDP that the PoC Client is capable of buffering RTP Media prior to being sent from the PoC Client to the PoC server. Permissible offered values are maximum buffer size, in octets, or "0" if not supported or requested. If <code>tb_txbufsize</code> is present in a SDP offer from the PoC Client with a nonzero value it is indicating the maximum amount of media in octets it is willing to buffer. The PoC Server can only include the <code>tb_txbufsize</code> parameter in the SDP answer if a <code>tb_txbufsize</code> was included in the SDP offer. If the SDP answer contains a nonzero value of <code>tb_txbufsize</code> equal to the SDP offer, the PoC Client is allowed to buffer RTP Media up to the size in octets of the value of <code>tb_txbufsize</code> in the answer until it receives a Media Burst granted . The PoC Client can expect receipt of MBCP Media Burst Granted before the buffer of size indicated in the answer is full. If the SDP answer contains a value of <code>tb_txbufsize=0</code> or no <code>tb_txbufsize</code> parameter, the PoC Client should not expect receipt of the TBCP Talk Burst Granted message before potential buffer overflow. The "<code>tb_txbufsize</code>" parameter can only be included if the "<code>multimedia</code>" parameter with value 1 is also included.</p>
<code>tb_txbw:</code>	<p>This optional parameter is used to indicate using SDP the bandwidth available to transmit RTP Media from the PoC Client to the PoC Server. Permissible offered values are maximum transmit bandwidth, in kilobits per second. If <code>tb_txbw</code> is present in an SDP offer from the PoC Client with a nonzero value it is indicating the maximum bandwidth available to transmit RTP Media. The <code>tb_txbw</code> is not valid in an SDP answer. The "<code>tb_txbw</code>" parameter can only be included if the "<code>multimedia</code>" parameter with value 1 is also included.</p>
<code>poc_sess_priority:</code>	<p>This parameter is used to negotiate and indicate that the optional PoC Session priority is used, as it applies to handling of the RTP Media stream. Permissible</p>

values are 0 and 1. If poc_sess_priority=1, Primary PoC Session priority to this PoC Session. If poc_sess_priority=0 or if the poc_sess_priority parameter is not present in a SDP offer from the PoC Client the PoC Client is indicating that it wishes to assign the Secondary PoC Session priority to this PoC Session. The PoC Server can include a poc_sess_priority parameter in the SDP answer if it was present in the SDP offer from the PoC Client. If poc_sess_priority =1 was present in the SDP offer the PoC Server indicates that it has set the priority of this PoC Session to Primary PoC Session priority by including poc_sess_priority=1 in the answer. If poc_sess_priority=0 was present in the SDP offer the PoC Server indicates that it has set the priority of this PoC Session to Secondary PoC Session priority by including poc_sess_priority=0 in the SDP answer. If no poc_sess_priority parameter is included in the SDP answer then Secondary PoC Session priority is assigned for this PoC Session. The PoC Server does not include the poc_sess_priority parameter in a SDP offer and the PoC Client does not include the poc_sess_priority parameter in a SDP answer, however the PoC Server does forward the poc_sess_priority parameter in forwarded requests and responses.

- poc_lock: This parameter is used to negotiate and indicate the PoC Session locking priority as it applies to the handling of the RTP Media stream during Simultaneous PoC Sessions. Permissible values are 0 and 1. If poc_lock=1 is present in a SDP offer from the PoC Client the PoC Client is indicating support for PoC Session locking priority and that it wishes to lock this PoC Session. If poc_lock= 0 or if the poc_lock parameter is not present in a SDP offer from the PoC Client the PoC Client is indicating that it wishes to unlock this PoC Session. The PoC Server can include a poc_lock parameter in the SDP answer if it was present in the SDP offer from the PoC Client. If poc_lock=1 was present in the SDP offer the PoC Server indicates that it has locked this PoC Session by including poc_lock=1 in the answer. If poc_lock=0 was present in the SDP offer the PoC Server indicates that it has unlocked this PoC Session by including poc_lock=0 in the SDP answer. If no poc_lock parameter is included in the SDP answer then this PoC Session is unlocked. The PoC Server does not include the poc_lock parameter in a SDP offer and the PoC Client does not include the poc_lock parameter in a SDP answer, however the PoC Server does forward the poc_lock parameter in forwarded requests and responses.
- local_grant: This optional parameter is used to negotiate and indicate using SDP whether the PoC Client and the PoC Server have the locally granted Talk Burst capability. Permissible values, if parameter is present, are 0 and 1. If local_grant=1 is present in an SDP offer from the PoC Client or from the PoC Server, the PoC Client or the PoC Server, respectively, is indicating that it supports locally granted Talk Burst mode. If local_grant=0 or if local_grant parameter is not present in the SDP offer from the PoC Client or the PoC Server, the PoC Client or the PoC Server, respectively, indicates that it does not support locally granted Talk Burst. The PoC Client and PoC Server can include a local_grant parameter in the SDP answer if it was present in the received SDP offer. If local_grant=1 is included in the SDP answer, it indicates that PoC Client or PoC Server supports locally granted Talk Burst mode. If local_grant=0 or parameter is not present in the SDP answer, it indicates that locally granted Talk Burst is not supported by the PoC Server or PoC Client.
- imp_mb_req: This optional parameter is used to negotiate and indicate using SDP that Media Burst is implicitly requested. The permissible values are 0 and 1. This parameter is included under the media level definition of the Media-floor Control Entity where implicit Media Burst is requested. This parameter is not needed for Media-floor Control Entity for which only PoC Speech is bound in case of 1-1 PoC Session, Ad-hoc PoC Group Session or Pre-arranged PoC Group Session is established.

If `imp_mb_req=1` is included in the SDP offer under the media level definition of a Media-floor Control Entity, the PoC Client indicates that it would like to perform an implicit Media Burst request for that Media-floor Control Entity. If `imp_mb_req=0` or the parameter is not present in the SDP offer from the PoC Client, the PoC Client either does not support implicit Media Burst request or does not want to perform the implicit Media Burst request for the particular Media-floor Control Entity. The PoC Server performing the Controlling PoC Function can include `imp_mb_req=1` in the SDP answer if `imp_mb_req=1` was included in the SDP offer from the PoC Client. If the SDP answer from the PoC Server contains the `imp_mb_req=1`, the PoC Server indicates that it supports implicit Media Burst request for the particular Media-floor Control Entity and also that PoC Server behaves as if it had received a Media Burst request from the PoC Client. If `imp_mb_req=0` or parameter is not present in the SDP answer from the PoC Server, the PoC Server indicates that the implicit Media Burst request is not supported for that Media-floor Control Entity.

The receipt of `imp_mb_req=1` from the PoC Server does not mean that Media Burst is granted, but just that PoC Server behaves as if Media Burst request had been received from the PoC Client.

Encoding considerations:	This type is defined for transfer over UDP and uses the same encoding as RTCP (RFC3550).
Restrictions on usage:	None
Security considerations:	See Section 14 in RFC3550
Interoperability considerations:	None
Published specification:	OMA-CP-PoC-V2_0
Applications which use this media type:	OMA Push to talk over Cellular applications
Additional information:	None
Intended usage:	COMMON

E.3.1.1 Mapping TBCP MIME parameters into SDP

The information carried in the MIME application type has a specific mapping to fields in SDP and are used in a SDP offer and a SDP answer to negotiate the chosen Media Burst Control Protocol and the Media Burst Control Protocol options.

A MBCP connection SHALL be described by using an SDP m line. According to [RFC2327] the m-line format is the following:

```
m=<media> <port> <transport> <fmt list>
```

For TBCP and MBCP:

- The media type field (MIME type) SHALL have a value of "application".
- The port field SHALL include the transport port for the TBCP.
- The transport field SHALL have the value of "udp"
- The format list field (MIME type) SHALL have the value of "TBCP".

NOTE: TBCP is specified in PoC 1.0 and can be used with PoC Speech in PoC 2.0. MBCP is the only Media Burst Control Protocol specified in this release. Future releases can specify additional Media Burst Control protocols that could be added to the format list.

The following is an example of an m-line for a MBCP connection

```
m=application 20000 udp TBCP
```

TBCP options go in the SDP "a=fmtp" attribute by copying them directly from the MIME media type string as a semicolon separated list of parameter=value pairs.

The following is an example of an attribute line for TBCP options.

```
a=fmtp:TBCP multimedia=1;queuing=1;tb_priority=2;timestamp=1;tb_granted=1;poc_sess_priority=0;poc_lock=1
```

E.3.2 QoE Profile

The QoE Profile attribute is an SDP attribute and it is used to inform about PoC2.0 QoE Profiles.

The QoE Profile attribute is a 'session-level' attribute, as specified in [RFC 4566], The ABNF for the QoE Profile attribute is defined as follows:

```
"a=poc-qoe:" qoe-profile SP [strength-tag]
; the presence of the strength-tag is optional
qoe-profile =("basic" / "premium" / "professional" / "government-use"/ token)
; token can be used for new values of qoe-profile to be defined in the future
strength-tag = "mandatory"
```

The values of the qoe-profile correspond to the QoE Profiles defined by PoC 2.0 as follows:

- "basic": Indicates a 'Basic' QoE Profile.
- "premium": Indicates a 'Premium' QoE Profile.
- "professional": Indicates a 'Professional' QoE Profile.
- "government-use": Indicates 'Official Government Use' QoE Profile.

NOTE: The list of values can be extended in the future,

The qoe-profile indicates the following information for PoC 2.0:

- Provides the QoE Profile assigned to the PoC Session when:
 - It is included in the SDP body of SIP requests initiated by the Controlling PoC Function and sent towards an Invited PoC User.
 - It is included in the SDP body of SIP responses sent from the Controlling PoC Function towards the Inviting PoC User (i.e: SIP Response to a SIP Request sent by the Inviting PoC User).
- Provides the Local QoE Profile of the PoC User when:
 - It is included in the SDP body of SIP requests initiated by the Inviting PoC User and sent towards the Controlling PoC Function. In this case, the Local QoE Profile is the QoE Profile being requested by the Inviting PoC User.
 - It is included in the SDP body of SIP responses sent from an Invited PoC User towards the Controlling PoC Function (i.e: SIP Response to a SIP Request sent by the Controlling PoC Function).

The inclusion of the strength-tag is optional. When present, it informs that the Invited PoC User must support the indicated QoE Profile in order to be included in the PoC Session.

Example 1:

In this example, the Inviting PoC User is requesting 'Premium' QoE Profile for the PoC Session

```
a=poc-qoe:premium
```

Example 2:

In this example, the Controlling PoC Function is indicating that support of 'Professional' QoE Profile is mandatory for the PoC Session

```
a=poc-qoe:professional mandatory
```

E.4 General

E.4.1 Release version in User-agent and Server headers

User-Agent and Server headers are used to indicate the release version and product information of the PoC Clients, PoC Servers and PoC Boxes.

The PoC Client, the PoC Server and the PoC Box shall implement the User-Agent and Server headers, according to rules and procedures of [RFC3261] with the clarifications in this subclause specific for PoC.

The User-Agent and Server headers ABNF are specified in [RFC3261] and extended as follows:

```
Server = "Server" HCOLON server-val *(LWS server-val)
User-Agent = "User-Agent" HCOLON server-val *(LWS server-val)
server-val = product / comment
product = poc-product / token [SLASH product-version]
product-version = token
```

This specification allows having several server-val tags. The first of those server-val tags shall be encoding according to the following ABNF:

```
poc-product = "PoC-" poc-device-token (SLASH poc-product-version)
poc-device-token = "client" | "serv" | "nwbox" | "uebox" | token
poc-product-version = "OMA2.0"
```

Where

```
client = PoC Client
serv = PoC Server
nwbox = NW PoC Box
uebox = UE PoC Box
poc-product-version = OMA PoC release version
```

Example 1:

In this example PoC Client acting as UAC and the PoC Server acting as UAS are OMA PoC release version 2.0 products. The PoC Client has inserted its own company and product name and version "Acme-Talk5000/v1.01".

```
User-Agent: PoC-client/OMA2.0 Acme-Talk5000/v1.01
```

```
Server: PoC-serv/OMA2.0
```

Example 2:

In this example both the PoC Server acting as UAC and the PoC Client acting as UAS are OMA PoC release version 2.0 products.

User-Agent: PoC-serv/OMA2.0

Server: PoC-client/OMA2.0

Example 3:

In this example both the PoC Server acting as a UAC and the UE PoC Box acting as UAS are OMA PoC release version 2.0 products.

User-Agent: PoC-serv/OMA2.0

Server: PoC-uebox/OMA2.0

E.5 URI parameters

E.5.1 Session Type uri-parameter

Session Type uri-parameter is used to indicate the type of the PoC Session. The Session Type uri-parameter takes the form:

```
session="sessiontype  
sessiontype="adhoc" | "prearranged" | "chat" | "1-1"
```

Example 1:

In this example the Controlling PoC Server is inviting a PoC User to a Pre-arranged PoC Group.

```
session=prearranged
```

E.5.2 Dispatch Type uri-parameter

The Dispatch Type uri-parameter is used to indicate the type of Dispatch PoC Session. The Dispatch Type uri-parameter takes the form:

```
"dispatch="dispatchtype  
dispatchtype=("entire-group" | "sub-group" | token)
```

The support of the Dispatch Type uri-parameter is optional:

- "dispatch=entire-group" corresponds to a Dispatch PoC Session with the entire Dispatch PoC Group
- "dispatch=sub-group" corresponds to a Dispatch PoC Session with a subset of the Dispatch PoC Group

The values of the Dispatch Type uri-parameter can be extended in the future by using the token considered in the definition
Example 1:

In this example the Controlling PoC Server is inviting a PoC User to a Dispatch PoC Session with a subset of the Dispatch PoC Group.

```
dispatch=sub-group
```

E.5.3 Back to back UA uri-parameter

The b2bua uri-parameter is used to indicate if the PoC Server performing the Participating PoC Function acts as a B2BUA and stays on the Media path during the PoC Session.

The support of the b2bua uri-parameter is optional:

"b2bua" corresponds to a case, when Participating PoC Function acts as a B2BUA and stays on the Media path.

E.5.4 URI Usage Type uri-parameter

URI Usage Type uri-parameter can be used to indicate the usage of the URI in a MIME resource-lists body. The URI Usage Type uri-parameter takes the form:

```
uriusage="uriusagetype
uriusagetype ="user" | "group" | token
```

Example 1:

In this example the URI Usage Type parameters indicates that the Inviting PoC User expects that the URI identifies a Group.

```
sip:PoC-GroupB@networkB.net;uriusage=group
```

Example 2:

In this example the URI Usage Type uri-parameter indicates that the Inviting PoC User expects that the URI identifies a PoC User.

```
sip:PoC-UserB@networkB.net;uriusage=user
```

E.6 XML Schema Extensions

E.6.1 Extensions to PoC-Settings

E.6.1.1 Structure

The general PoC Service Settings structure is described in [RFC4354] with the PoC V2.0 specific extensions described in this subclause.

The following elements and attributes extending the <entity> child element of the <poc-settings> element are used by PoC Enabler:

- a) a <ipii-settings> element containing the Invited Parties Identity Information Mode setting;
- b) a <inc-media-settings> element containing the Included Media Content in a Request Support setting;
- c) a <ref-media-settings> element containing the Referenced Media Content in a Request Support setting;
- d) a <text-content-settings> element containing the Text Content in a Request Support setting;
- e) a <pocbox-settings> element containing the PoC Box use setting;
- f) a <privacy-settings> element containing the Privacy setting.

The following elements and attributes of the <ipii-settings> element are used by PoC Enabler:

- a) the <invited-party-identity-information> element.

The following elements and attributes of the <inc-media-settings> element are used by PoC Enabler:

- a) the <included-media-support> element.

The following elements and attributes of the <ref-media-settings> element are used by PoC Enabler:

- a) the <referenced-media-support> element.

The following elements and attributes of the <text-content-settings> element are used by PoC Enabler:

- a) the <text-content-support> element.

The following elements and attributes of the <pocbox-settings> element are used by PoC Enabler:

- a) the <pocbox-use> element.

The following elements and attributes of the <privacy-settings> element are used by PoC Enabler:

- a) the <privacy> element.

The following elements and attributes of the <invited-party-identity-information> element are used by PoC Enabler:

- a) the "active" attribute.

The following elements and attributes of the <included-media-support> element are used by PoC Enabler:

- a) the "active" attribute.

The following elements and attributes of the <referenced-media-support> element are used by PoC Enabler:

- a) the "active" attribute.

The following elements and attributes of the <text-content-support> element are used by PoC Enabler:

- a) the "active" attribute.

E.6.1.2 XML Schema

This XML Schema uses the extendable space for other PoC Service Settings in [RFC4354] to define the PoC V2.0 specific Service Settings.

The following XML namespace prefix SHALL be used, when generating PoC Service Settings document:

```
xmlns:PoC2Set="urn:oma:xml:poc:poc2.0-settings"
```

The Extended Service Settings SHALL conform to the XML schema described in [OMA-POC-POC2.0-SETTINGS].

E.6.1.3 Validation Constraints

None.

E.6.1.4 Data Semantics

The data semantics of the PoC V2.0 specific extensions are specified in this subclause.

The <invited-party-identity-information> element is used to indicate whether the PoC Client supports the Invited Parties Identity Information Mode. The value for the "active" attribute is of Boolean type. The possible values are:

- "false" instructs the Home PoC Server to not deliver the invited parties identity information to the PoC Client for the Served PoC User. This is the default value in absence of the element.
- "true" instructs the Home PoC Server to deliver the invited parties identity information to the PoC Client for the Served PoC User.

The <included-media-support> element is used to indicate whether the PoC Client supports Media Content included in a request. The value for the "active" attribute is of Boolean type. The possible values are:

- "false" instructs the Home PoC Server to remove any Media Content included in the request before forwarding the request to the PoC Client for the Served PoC User. This is the default value in absence of the element.
- "true" instructs the Home PoC Server to forward any Media Content included in the request to the PoC Client for the Served PoC User.

The <referenced-media-support> element is used to indicate whether the PoC Client supports Referenced Media Content included in a request. The value for the "active" attribute is of Boolean type. The possible values are:

- "false" instructs the Home PoC Server to remove any reference to Media Content included in the request before forwarding the request to the PoC Client for the Served PoC User. This is the default value in absence of the element.
- "true" instructs the Home PoC Server to forward any reference to Media Content included in the request to the PoC Client for the Served PoC User.

The <text-content-support> element is used to indicate whether the PoC Client supports Text Content included in a request. The value for the "active" attribute is of Boolean type. The possible values are:

- "false" instructs the Home PoC Server to remove any Text Content included in the request before forwarding the request to the PoC Client for the Served PoC User. This is the default value in absence of the element.
- "true" instructs the Home PoC Server to forward any Text Content included in the request to the PoC Client for the Served PoC User.

The <pocbox-use> element is used to indicate whether the PoC Client wants to route the request to a PoC Box or whether the routing to a PoC Box is subject to conditions. The values are of enumerated string type. The possible values are:

- "unwilling" instructs the Home PoC Server to not route the request to the UE PoC Box or NW PoC Box of the Served PoC User. This is the default value in absence of the element.
- "unconditional" instructs the Home PoC Server to route the request to the UE PoC Box or NW PoC Box of the Served PoC User based on the PoC Box access rules for the default PoC Box, i.e. the <pocbox-type> element, as specified in [OMA-PoC-Document-Mgmt] unconditionally.
- "conditional" instructs the Home PoC Server to route the request to the UE PoC Box or NW PoC Box of the Served PoC User based on the PoC Box access rules for the default PoC Box , i.e. the <pocbox-type> element, as specified in [OMA-PoC-Document-Mgmt]only conditionally.

The <privacy> element is used to indicate whether the PoC Client wants to be anonymous or not. The values are of enumerated string type. The possible values are:

- "none" instructs the Home PoC Server to allow the identity of the PoC Client for the Served PoC User in responses to requests by including the value in the Privacy header. This is the default value in absence of the element.
- "id" instructs the Home PoC Server to not reveal the identity of the PoC Client for the Served PoC User in responses to requests by including the value in the Privacy header.

E.6.1.5 XML example of PoC2.0 Service Settings

The following is an example of a PoC-settings document:

```
<?xml version="1.0" encoding="UTF-8"?>

<poc-settings xmlns="urn:oma:params:xml:ns:poc:poc-settings"
  xmlns:PoC2Set="urn:oma:xml:poc:poc2.0-settings">
  <entity id="do39s8zksn2d98x">
    <isb-settings>
```

```
<incoming-session-barring active="true"/>
</isb-settings>
<am-settings>
  <answer-mode>automatic</answer-mode>
</am-settings>
<ipab-settings>
  <incoming-personal-alert-barring active="false"/>
</ipab-settings>
<sss-settings>
  <simultaneous-sessions-support active="true"/>
</sss-settings>
<PoC2Set:ipii-settings>
  <PoC2Set:invited-party-identity-information active="true"/>
</PoC2Set:ipii-settings>
<PoC2Set:inc-media-settings>
  <PoC2Set:included-media-support active="true"/>
</PoC2Set:inc-media-settings>
<PoC2Set:ref-media-settings>
  <referenced-media-support active="true"/>
</PoC2Set:ref-media-settings>
<PoC2Set:text-content-settings>
  <PoC2Set:text-content-support active="true"/>
</PoC2Set:text-content-settings>
<PoC2Set:pocbox-settings>
  <PoC2Set:pocbox-use>conditional</PoC2Set:pocbox-use>
</PoC2Set:pocbox-settings>
<PoC2Set:privacy-settings>
  <PoC2Set:privacy>none</PoC2Set:privacy>
</PoC2Set:privacy-settings>

</entity>
</poc-settings>
```

Appendix F. Examples of signalling flows (Informative)

NOTE: The signalling flows in this appendix do not yet reflect changes due to new PoC2.0 procedures. Updates of the example flows and the addition of new examples addressing PoC2.0 procedures will occur before the approval of the PoC2.0 Enabler.

This Appendix contains informative example flows for the Control Plane Signaling for the PoC enabler. These flows are informative examples only and the normative part of the specification is what is required to be implemented in order to be compliant with this specification. In the event of any discrepancy between these examples and the normative part of the specification it is the normative part of the specification that is to be implemented. The SIP message contents described in these flows are only those headers, parameters and elements that are part of the PoC enabler. Additional headers, parameters and elements will be required by [RFC3261], [RFC2327] and also by the SIP/IP core and these are not shown here. In these flows 3GPP IMS is assumed for the SIP/IP core and the P-Asserted-Identity header is shown for the Authenticated Originator's PoC Address. It is also assumed that all PoC Servers are part of the IMS trust domain.

F.1 SIP registration and publication of PoC Service Settings event

The PoC User A at the PoC Client A registers with SIP/IP Core A. The registration contains contact information about the PoC Client and a UE PoC Box co-located on the UE. The PoC Box is registered with a lower q-value than the PoC Client i.e. when the PoC User is invited to a PoC Session the SIP/IP Core will first send the SIP INVITE request to the PoC Client unless the UE PoC Box is the target.

The flow assumes that the PoC Client registers with the Government Use QoE profile.

When the registration is completed the PoC Client A publishes its current PoC Service Settings to PoC Server A.

This flow is as shown in Figure 3 "*PoC Client A SIP registers with the SIP/IP Core A, and PoC Client A publishes PoC Service Settings*".

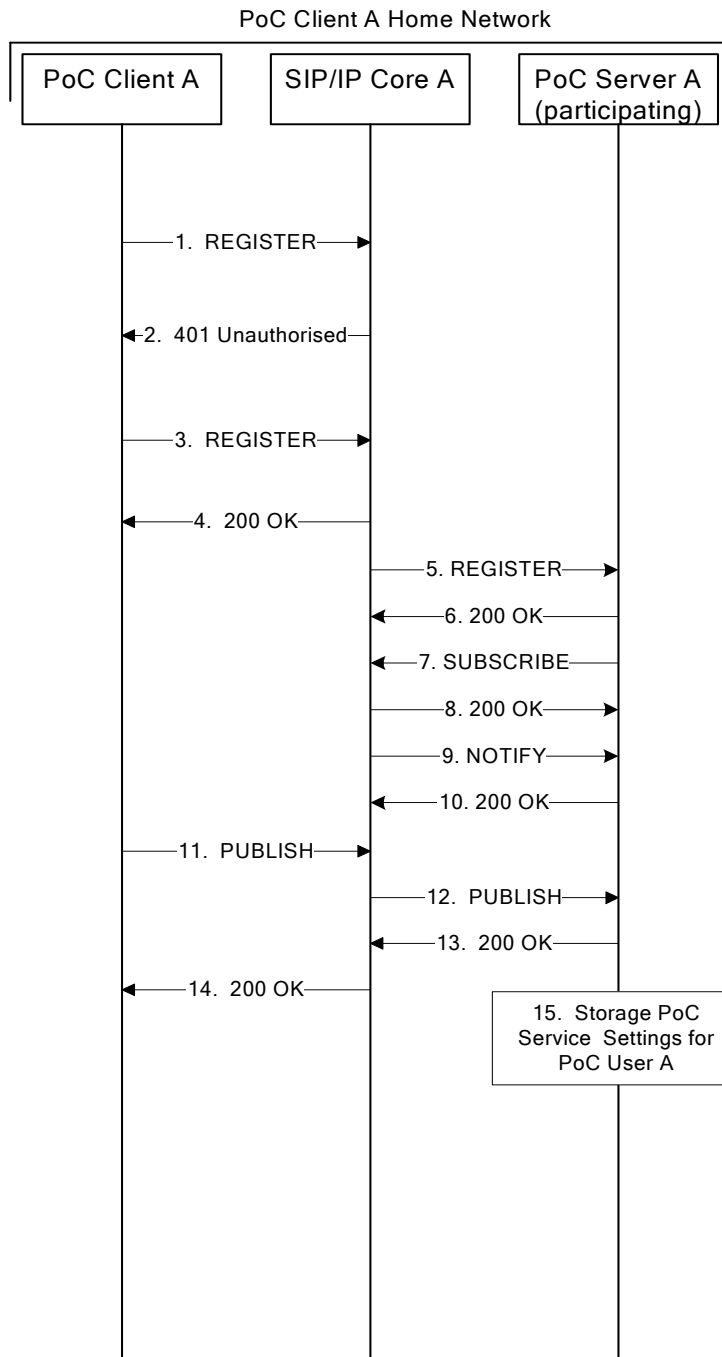

Figure 3: PoC Client A SIP registers with the SIP/IP Core A and PoC Client A publishes PoC Service Settings

The IP address and port in the host part of the URI in the Contact header of the SIP REGISTER request and the SIP PUBLISH request is replaced by PoCClientA.networkA.net for readability.

The steps of the flows are as follows:

- 1. SIP REGISTER request (from PoC Client A to SIP/IP Core A)**

The PoC Client A sends a SIP REGISTER request containing the PoC feature tag '+g.poc.talkburst' in the contact header to the SIP/IP Core A.

SIP HEADERS

From: <sip:PoC-UserA@networkA.net>;tag=4fa3

To: <sip:PoC-UserA@networkA.net>

User-Agent: PoC-client/OMA2.0 Acme-Talk5000/v1.01

Authorization: Digest username="PoC-UserA-private@networkA.net", realm="registrar.networkA.net", nonce="", uri="sip:registrar.networkA.net"

Require pref

Resource-Priority wps.2

Contact: <sip:PoC-ClientA@PoCClientA.networkA.net>;
+sip.instance="<urn:uuid:00000000-0000-1000-8000-000A95A0E128>";
+g.poc.talkburst; +g.poc.groupad; +g.poc.dispatcher; +g.poc.discretemedia;
+g.poc.fdcfo;q=1

Contact: <sip:UE-PoC-BoxA@PoCClientA.networkA.net>;
+sip.instance="<urn:uuid:00000000-0000-1000-8000-000A95A0E128>";
sip.automata; sip.actor="principal"; sip.description="poc recording device";
+g.poc.talkburst;q=0.5

2. SIP 401 "Unauthorized" response (from SIP/IP Core A to PoC Client A)

The SIP/IP Core A requires authentication of the registration of PoC Client A and responds with a SIP 401 "Unauthorized" response containing an authentication challenge in the WWW-Authenticate header.

3. SIP REGISTER request (from PoC Client A to SIP/IP Core A)

The PoC Client A sends another SIP REGISTER request containing the PoC feature tag '+g.poc.talkburst' in the contact header and the authentication response in the Authorization header to the SIP/IP Core A.

SIP HEADERS

From: <sip:PoC-UserA@networkA.net>;tag=4fa3

To: <sip:PoC-UserA@networkA.net>

User-Agent: PoC-client/OMA2.0 Acme-Talk5000/v1.01

Authorization: Digest username="PoC-UserA-private@networkA.net", realm="registrar.networkA.net", nonce=base64(RAND + AUTN + server specific data), algorithm=AKAv1-MD5, uri="sip:registrar.networkA.net", response="6629fae49393a05397450978507c4ef1"

Require pref

Resource-Priority wps.2

Contact: <sip:PoC-ClientA@PoCClientA.networkA.net>;
+sip.instance="<urn:uuid:00000000-0000-1000-8000-000A95A0E128>";
+g.poc.talkburst; +g.poc.groupad;
+g.poc.dispatcher;+g.poc.discretemedia;+g.poc.fdcfo;q=1

Contact: <sip:UE-PoC-BoxA@PoCClientA.networkA.net>;
 +sip.instance="urn:uuid:00000000-0000-1000-8000-000A95A0E128";
 sip.automata; sip.actor="principal"; sip.description="poc recording
 device";+g.poc.talkburst;q=0.5

4. SIP 200 "OK" response (from SIP/IP Core A to PoC Client A)

The SIP/IP Core A acknowledges the SIP REGISTER request with a SIP 200 "OK" response to the PoC Client A.

5. SIP REGISTER request (from SIP/IP Core A to the PoC Server A)

The SIP/IP Core sends a REGISTER request to the PoC Server A based on the Initial Filter Criteria.

SIP HEADERS

From: <sip:PoC-UserA@networkA.net>;tag=lll4A
To: <sip:PoC-UserA@networkA.net>
Supported reg
Contact: < sip:registrar.networkA.net>

6. SIP 200 "OK" response (from PoC Server A to SIP/IP Core A)

The PoC Server A acknowledges the SIP REGISTER request with a SIP 200 "OK" response to the SIP/IP Core A.

7. SIP SUBSCRIBE request (from PoC Server A to SIP/IP Core A)

SIP HEADERS

Request-URI <sip:PoC-UserA@networkA.net>
Event: reg
P-Asserted-Identity: <sip:PoC-ServerA@networkA.net>
Contact: <sip:PoC-ServerA@networkA.net>
Accept: application/reginfo+xml

8. SIP 200 OK response (from SIP/IP Core A to PoC Server A)

The SIP/IP Core A acknowledges the SIP SUBSCRIBE request with a SIP 200 "OK" response to the PoC Server A.

9. SIP NOTIFY request (from SIP/IP Core A to PoC Server A)

Request-URI sip:PoC-ServerA@networkA.net

SIP HEADERS

Contact <sip:PoC-ServerX@networkX.net >
Event: reg

Content-Type: application/conference-info+xml

Subscription-State: active;expires=3600

XML MIME BODY

```
<?xml version="1.0"?>
  <reginfo xmlns="urn:ietf:params:xml:ns:reginfo"
    version="1" state="partial">
    <registration aor="sip:PoC-UserA@networkA.net" id="a7" state="active">
      <contact id="76" state="active" event="registered">
        <uri> sip:PoC-ClientA@PoCClientA.networkA.net </uri>
        <unknown-param name="+sip.instance">urn:uuid:00000000-0000-
1000-8000-000A95A0E128</unknown-param>
        <unknown-param name="+g.poc.talkburst"/>
        <unknown-param name="+g.poc.groupad"/>
        <unknown-param name="+g.poc.dispatcher"/>
        <unknown-param name="+g.poc.discretemedia"/>
        <unknown-param name="+g.poc.fdcfo"/>
      </contact>
      <contact id="77" state="active" event="registered">
        <uri> sip:UE-PoC-BoxA@ PoCClientA.networkA.net</uri>
        <unknown-param name="+sip.instance">urn:uuid:00000000-
0000-1000-8000-000A95A0E128</unknown-param>
        <unknown-param name="+g-poc.talkburst"/>
        <unknown-param name="sip.automata"/>
        <unknown-param name="sip.actor"> principal</unknown-param>
        <unknown-param name="sip.description">poc recording
device"</unknown-param>
      </contact>
    </registration>
  </reginfo>
```

10. SIP 200 "OK" response (from PoC Server A to SIP/IP Core A)

The PoC Server A acknowledges the SIP NOTIFY request with a SIP 200 "OK" response to the SIP/IP Core A.

11. SIP PUBLISH request (from PoC Client A to SIP/IP Core A)

The PoC Client A publishes the current PoC Service Settings of PoC Client A by sending a SIP PUBLISH request for the event package "poc-settings" to SIP/IP Core A. This is the normal scenario as the PoC Server has no PoC Service Settings until published by the PoC Client, however in the case that more than one PoC Client is registered for the same PoC User the PoC Client may (possibly through interaction with the PoC User) determine not to override the current PoC Service Settings.

Request-URI sip:PoC-ClientA@networkA.net

SIP HEADERS

P-Preferred-Identity: "PoC User A" <sip:PoC-UserA@networkA.net>

Accept-Contact: *,+g.poc.talkburst; require;explicit

User-Agent: PoC-client/OMA2.0 Acme-Talk5000/v1.01

Resource-Priority wps.2

Expires: 360000

Event: poc-settings

Content-Type: application/poc-settings+xml

XML MIME BODY

```
<?xml version="1.0" encoding="UTF-8"?>

  <poc-settings xmlns="urn:oma:params:xml:ns:poc:poc-settings"
    xmlns:xsi="http://www.w3.org/2001/XMLSchema-instance"
    xsi:schemaLocation="urn:oma:params:xml:ns:poc:poc-settings"
    xmlns:PoC2Set="urn:oma:xml:poc:poc2.0-settings">
<entity id="do39s8zksn2d98x">
  <isb-settings>
    <incoming-session-barring active="false"/>
  </isb-settings>
  <am-settings>
    <answer-mode>automatic</answer-mode>
  </am-settings>
  <ipab-settings>
```

```
<incoming-personal-alert-barring active="false"/>
</ipab-settings>
<sss-settings>
<simultaneous-sessions-support active="true"/>
</sss-settings>
<PoC2Set:ipii-settings>
<PoC2Set:invited-party-identity-information active="true"/>
</PoC2Set:ipii-settings>
<PoC2Set:ims-settings>
<PoC2Set:included-media-support active="true"/>
</PoC2Set:ims-settings>
<PoC2Set:rms-settings>
<PoC2Set:referenced-media-support active="true"/>
</PoC2Set:rms-settings>
<PoC2Set:tcs-settings>
<PoC2Set:text-content-support active="true"/>
</PoC2Set:tcs-settings>
<PoC2Set:pocbox-settings>
<PoC2Set:pocbox-use>conditional</PoC2Set:pocbox-use>
</PoC2Set:pocbox-settings>
<PoC2Set:privacy-settings>
<PoC2Set:privacy>none</PoC2Set:privacy>
</PoC2Set:privacy-settings>
</entity>
</poc-settings>
```

12. SIP PUBLISH request (from SIP/IP Core A to PoC Server A)

The SIP/IP Core A forwards the SIP PUBLISH request to the PoC Server A.

Request-URI sip:PoC-ClientA@networkA.net

SIP HEADERS

P-Asserted-Identity: "PoC User A" <sip:PoC-UserA@networkA.net>
Accept-Contact: *,+g.poc.talkburst; require;explicit
User-Agent: PoC-client/OMA2.0 Acme-Talk5000/v1.01
Resource-Priority: wps.2
Expires: 360000
Event: poc-settings
Content-Type: application/poc-settings+xml

XML MIME BODY

```
<?xml version="1.0" encoding="UTF-8"?>

  <poc-settings xmlns="urn:oma:params:xml:ns:poc:poc-settings"
    xmlns:xsi="http://www.w3.org/2001/XMLSchema-instance"
    xsi:schemaLocation="urn:oma:params:xml:ns:poc:poc-settings"
    xmlns:PoC2Set="urn:oma:xml:poc:poc2.0-settings">
<entity id="do39s8zksn2d98x">
  <isb-settings>
    <incoming-session-barring active="false"/>
  </isb-settings>
  <am-settings>
    <answer-mode>automatic</answer-mode>
  </am-settings>
  <ipab-settings>
    <incoming-personal-alert-barring active="false"/>
  </ipab-settings>
  <sss-settings>
    <simultaneous-sessions-support active="true"/>
  </sss-settings>
  <PoC2Set:ipii-settings>
    <PoC2Set:invited-party-identity-information active="true"/>
  </PoC2Set:ipii-settings>
  <PoC2Set:ims-settings>
```

```
<PoC2Set:included-media-support active="true"/>
</PoC2Set:ims-settings>
<PoC2Set:rms-settings>
<PoC2Set:referenced-media-support active="true"/>
</PoC2Set:rms-settings>
<PoC2Set:tcs-settings>
<PoC2Set:text-content-support active="true"/>
</PoC2Set:tcs-settings>
<PoC2Set:pocbox-settings>
<PoC2Set:pocbox-use>conditional</PoC2Set:pocbox-use>
</PoC2Set:pocbox-settings>
<PoC2Set:privacy-settings>
<PoC2Set:privacy>none</PoC2Set:privacy>
</PoC2Set:privacy-settings>
</entity>
</poc-settings>
```

13. SIP 200 "OK" response (from PoC Server A to SIP/IP Core A)

The PoC Client A acknowledges the SIP PUBLISH request with a SIP 200 "OK" response to the SIP/IP Core A.

SIP HEADERS

Server: PoC-serv/OMA2.0

14. SIP 200 "OK" response (from SIP/IP Core A to PoC Client A)

The SIP/IP Core A forwards the SIP 200 "OK" response to the PoC Client A.

SIP HEADERS

Server: PoC-serv/OMA2.0

15. PoC Server A stores the PoC Service Settings for PoC User A

PoC Server A stores the PoC Service Settings for PoC User A from the body of the SIP PUBLISH request from step 6.

F.2 PoC Client initiates a Pre-established Session

PoC Client A initiates a Pre-established Session by sending a SIP INVITE request to a PoC Server performing the Participating PoC Function via SIP/IP Core A.

The Pre-established Session contains PoC Speech and Video bound to the same Media-floor Control Entity and Discrete Media not bound to any Media-floor Control Entity.

The PoC Client A supports the Dispatcher capability and FDCFO.

QoE Profiles feature is used in this flow and PoC Client A requests Premium QoE Profile.

This flow is shown as in Figure 4 "PoC Client A initiates a Pre-established Session".

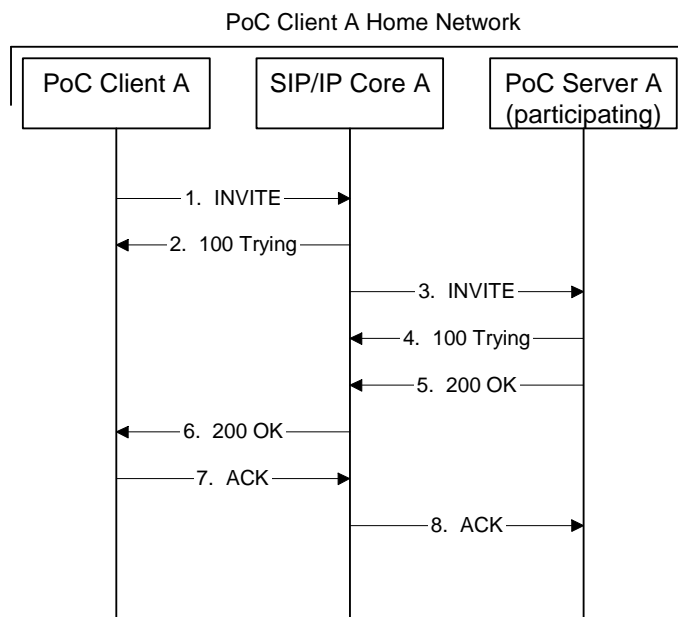

Figure 4: PoC Client A initiates a Pre-established Session

The steps of the flows are as follows:

1. SIP INVITE request (from PoC Client A to SIP/IP Core A)

The PoC Client A sends a SIP INVITE request with the Conference-factory-URI for the PoC service as the Request-URI to the SIP/IP Core A. The SIP INVITE request contains an SDP offer including necessary media parameters (e.g. PoC Client IP address, port number(s), supported codecs) and the Talk Burst Control Protocol.

If the PoC Client is not able or willing to receive media streams immediately then the PoC Client A sets the Media Stream to "inactive" when generating the SDP offer.

Request-URI sip:PoCConferenceFactoryURI.networkA.net

SIP HEADERS

P-Preferred-Identity: "PoC User A" <sip:PoC-UserA@networkA.net>

Accept-Contact: *;+g.poc.talkburst;require;explicit

User-Agent: PoC-client/OMA2.0 Acme-Talk5000/v1.01
Contact: <sip:PoC-ClientA.networkA.net>;+sip.instance="<urn:uuid:00000000-0000-1000-8000-000A95A0E128>";+g.poc.talkburst;+g.poc.dispatcher;+g.poc.fdcfo
Supported: Timer
Session-Expires: 1800;refresher=uac
Allow: INVITE,ACK,CANCEL,BYE,REFER, SUBSCRIBE,NOTIFY, OPTIONS
Accept-Language: en

SDP PARAMETERS

c= IN IP6 5555::aaa:bbb:ccc:ddd
a= poc-qoe:premium
m= audio 3456 RTP/AVP 97
a= rtpmap:97 AMR
a= rtcp:5560
i= speech
b= AS:25.4
a= label:aa
m= application 2000 udp TBCP
a= fmp:TBCP
 queuing=1;tb_priority=2;timestamp=1;multimedia=1;local_grant=1;imp_mb_req=1
a= floordid:0 mstrm:aa bb
m= video 5678 RTP/AVP 99
a= rtpmap:99 MP4V-ES
b= AS:75
a= label:bb
m= message 12345 TCP/MSRP *
a= accept-types:message/cpim application/vnd.oma.poc.final-report+xml
 application/vnd.oma.poc.detailed-progress-report+xml
 application/vnd.oma.poc.optimized-progress-report+xml
a= accept-wrap-types:text/plain
a= path:msrp://[5555::aaa:bbb:ccc:ddd]:12345/kjhd37s2s20w2a;tcp
a= max-size:10000

2. SIP 100 "Trying" response (from SIP/IP Core A to PoC Client A)

The SIP/IP Core A indicates that it has received the SIP INVITE request by sending a 100 "Trying" provisional response.

3. SIP INVITE request (from SIP/IP Core A to PoC Server A)

The SIP/IP Core A forwards the SIP INVITE request to the PoC Server A performing the Participating PoC Function for PoC Client A according to the SIP/IP Core A routing principles.

Request-URI sip:PoCConferenceFactoryURI.networkA.net

SIP HEADERS

P-Asserted-Identity: "PoC User A" <sip:PoC-UserA@networkA.net>

Accept-Contact: *;+g.poc.talkburst;require;explicit

User-Agent: PoC-client/OMA2.0 Acme-Talk5000/v1.01

Contact: <sip:PoC-ClientA.networkA.net>;+sip.instance="<urn:uuid:00000000-0000-1000-8000-000A95A0E128>;+g.poc.talkburst;+g.poc.dispatcher;+g.poc.fdcfo

Supported: Timer

Session-Expires: 1800;refresher=uac

Allow: INVITE,ACK,CANCEL,BYE,REFER, SUBSCRIBE,NOTIFY, OPTIONS

Accept-Language: en

SDP PARAMETERS

c= IN IP6 5555::aaa:bbb:ccc:ddd

a= poc-qoe:premium

m= audio 3456 RTP/AVP 97

a= rtpmap:97 AMR

a= rtcp:5560

i= speech

b= AS:25.4

a= label:aa

m= application 2000 udp TBCP

a= ftmp:TBCP
queuing=1;tb_priority=2;timestamp=1;multimedia=1;local_grant=1;imp_mb_req=1

a= floorid:0 mstrm:aa bb

m= video 5678 RTP/AVP 99

```

a=          rtpmap:99 MP4V-ES
b=          AS:75
a=          label:bb
m=          message 12345 TCP/MSRP *
a=          accept-types:message/cpim application/vnd.oma.poc.final-report+xml
            application/vnd.oma.poc.detailed-progress-report+xml
            application/vnd.oma.poc.optimized-progress-report+xml
a=          accept-wrap-types:text/plain
a=          path:msrp://[5555::aaa:bbb:ccc:ddd]:12345/kjhd37s2s20w2a;tcp
a=          max-size:10000

```

4. SIP 100 "Trying" response (from PoC Server A to SIP/IP Core A)

The PoC Server A indicates that it has received the SIP INVITE request by sending a SIP 100 "Trying" provisional response.

5. SIP 200 "OK" response (from PoC Server A to SIP/IP Core A)

The PoC Server A sends a SIP 200 "OK" as the final response to the SIP INVITE request via the SIP/IP Core A towards the PoC Client A to answer to the SDP offer. The SIP 200 "OK" response contains an SDP answer including the accepted media parameters (e.g. Codecs, PoC Server IP address, port number(s), supported codecs) and the accepted Talk Burst Control Protocol.

SIP HEADERS

```

P-Asserted-Identity: <sip:PoCConferenceFactoryURI.networkA.net>
Server: PoC-serv/OMA2.0
Contact <sip:Pre-establishedSessionIdentityA@PoC-
            ServerA.networkA.net>;+g.poc.talkburst;isfocus;+g.poc.dispatcher
Require: Timer
Session-Expires: 1800;refresher=uac
Allow: INVITE,ACK,CANCEL,BYE,PRACK,REFER, SUBSCRIBE, NOTIFY,
            OPTIONS
Supported: norefersub

```

SDP PARAMETERS

```

c=          IN IP6 57777::eee:fff:aaa:bbb
a=          poc-qoe:premium
m=          audio 57787 RTP/AVP 97
i=          speech

```



```

a=          label:xxx
a=          rtpmap:97 AMR
a=          rtcp:57000
m=          application 57790 udp TBCP
a=          fmp: TBCP
             queuing=1;tb_priority=2;timestamp=1;multimedia=1;local_grant=1;imp_mb_req=1
a=          floorid:0 mstrm:xxx yyy
m=          video 23456 RTP/AVP 99
a=          rtpmap:99 MP4V-ES
a=          label:yyy
m=          message 34567 TCP/MSRP *
a=          accept-types:message/cpim application/vnd.oma.poc.final-report+xml
             application/vnd.oma.poc.detailed-progress-report+xml
             application/vnd.oma.poc.optimized-progress-report+xml
a=          accept-wrap-types:text/plain
a=          path:msrp://[57777::eee:fff:aaa:bbb]:12345/jshA7weztas;tcp

```

6. SIP 200 (OK) response (from SIP/IP Core A to PoC Client A)

The SIP/IP Core A forwards the SIP 200 "OK" to the PoC Client A. The PoC Client A stores the content of the Contact header as the PoC Session Identity.

SIP HEADERS

```

P-Asserted-Identity:    <sip:PoCConferenceFactoryURI.networkA.net>
Server:                PoC-serv/OMA2.0
Contact                  <sip:Pre-establishedSessionIdentityA@PoC-
                           ServerA.networkA.net>;+g.poc.talkburst;isfocus;+g.poc.dispatcher
Require:                Timer
Session-Expires:       1800;refresher=uac
Allow:                  INVITE,ACK,CANCEL,BYE,PRACK,REFER, OPTIONS
Supported:              norefersub

```

SDP PARAMETERS

```

c=          IN IP6 57777::eee:fff:aaa:bbb
a=          poc-qoe:premium

```

```

m=          audio 57787 RTP/AVP 97
a=          rtpmap:97 AMR
a=          rtcp:57000
i=          speech
a=          label:xxx
m=          application 57790 udp TBCP
a=          fmtp:TBCP queuing=1; tb_priority=2;
           timestamp=1;multimedia=1;local_grant=1;imp_mb_req=1
a=          floorid:0 mstrm:xxx yyy
m=          video 23456 RTP/AVP 99
a=          rtpmap:99 MP4V-ES
a=          label:yyy
m=          message 34567 TCP/MSRP *
a=          accept-types:message/cpim application/vnd.oma.poc.final-report+xml
           application/vnd.oma.poc.detailed-progress-report+xml
           application/vnd.oma.poc.optimized-progress-report+xml
a=          accept-wrap-types:text/plain
a=          path:msrp://[57777::eee:fff:aaa:bbb]:12345/jshA7weztas;tcp

```

7. SIP ACK request (from PoC Client A to SIP/IP Core A)

The PoC Client A acknowledges the SIP 200 "OK" response with a SIP ACK request sent to the SIP/IP Core A.

8. SIP ACK request (from SIP/IP Core A to PoC Server A)

The SIP/IP Core A forwards the SIP ACK request to the PoC Server A.

F.3 Pre-established Session

F.3.1 Originating flow – Confirmed Indication

PoC Client A invites PoC Client B to a PoC Session by sending a SIP REFER request to the PoC Server. PoC Client A has created a Pre-established Session by using the mechanisms as shown in Figure 4 "*PoC Client A initiates a Pre-established Session*", and the PoC Client A has learned the URI that identifies this Session. This flow is as shown in Figure 5: "*PoC Client A invites another user to a Pre-established Session by sending a SIP REFER request to PoC Server A confirmed case*".

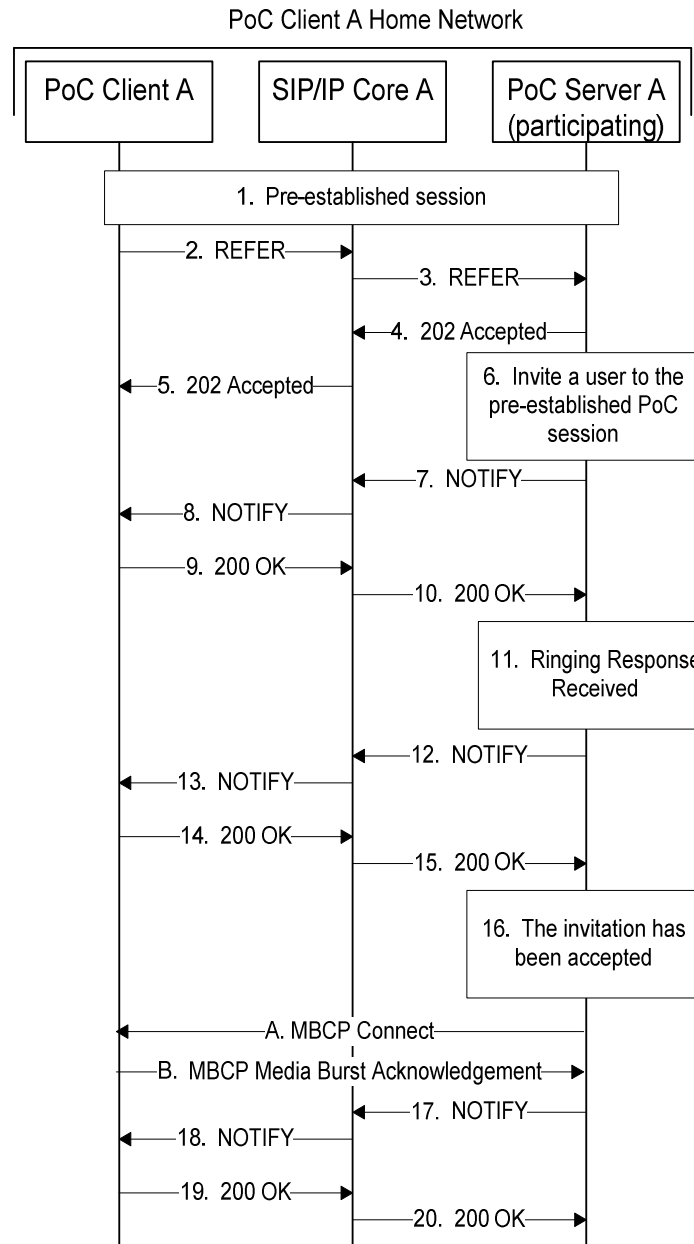

Figure 5: PoC Client A invites another user to a Pre-established Session by sending a SIP REFER request to PoC Server A confirmed case

The steps of the flows are as follows:

1. PoC Client A creates a Pre-established Session

PoC Client A creates a Pre-established Session and learns its URI as shown in Figure 4 "PoC Client A initiates a Pre-established Session".

2. SIP REFER request (from PoC Client A to SIP/IP Core A)

The PoC Client A invites the PoC Client B to the Pre-established Session.

Request-URI sip:Pre-establishedSessionIdentityA@PoC-ServerA.networkA.net

SIP HEADERS

Refer-To: <sip:PoC-UserB@networkB.net?Reject-Contact=sip.automata%3bsip.actor%3dmsg-taker%3brequire%3bexplicit&Reject-Contact=sip.automata%3bsip.actor%3dprincipal%3bsip.description%3d%22poc%20recording%20device%22%3brequire%3bexplicit&Subject=Let's%20talk&Alert-Info=%3chttp://publicweb.networkB.net/users/PoC-UserA%40networkA.net/myFavouriteRingingTone.wav%3e&Call-Info=%3chttp://publicweb.networkB.net/users/PoC-UserA%40networkA.net/myOwnPicture.jpg%3e%3bpurpose%3dicon>

Privacy: Id

Content-Type: text/directory;profile="vcard";charset=UTF-8

```
begin:vcard
fn:John P. Smith
n:Smith;John;Peter;Dr.;MBA
EMAIL:TYPE=internet:POC-UserB@networkA.net
version:3.0
end:vcard
```

NOTE: For a 1-1 PoC Session the SIP REFER request does not contain a body.

3. SIP REFER request (from SIP/IP Core A to PoC Server A)

The SIP/IP Core A forwards the SIP REFER request to the PoC Server A performing the Participating PoC Function of the PoC Client A according to the SIP/IP Core A routing principles.

Request-URI sip:Pre-establishedSessionIdentityA@PoC-ServerA.networkA.net

SIP HEADERS

Refer-To: <sip:PoC-UserB@networkB.net?Reject-Contact=sip.automata%3bsip.actor%3dmsg-taker%3brequire%3bexplicit&Reject-Contact=sip.automata%3bsip.actor%3dprincipal%3bsip.description%3d%22poc%20recording%20device%22%3brequire%3bexplicit&Subject=Let's%20talk&Alert-Info=%3chttp://publicweb.networkB.net/users/PoC-UserA%40networkA.net/myFavouriteRingingTone.wav%3e&Call-Info=%3chttp://publicweb.networkB.net/users/PoC-UserA%40networkA.net/myOwnPicture.jpg%3e%3bpurpose%3dicon>

Privacy: Id

Content-Type: text/directory;profile="vcard";charset=UTF-8

```

begin:vcard
fn:John P. Smith
n:Smith;John;Peter;Dr.;MBA
EMAIL:TYPE=internet:POC-UserB@networkA.net
version:3.0
end:vcard

```

4. SIP 202 "Accepted" response (from PoC Server A to SIP/IP Core A)

The PoC Server A indicates that it has received the SIP REFER request by sending a SIP 202 "Accepted" response. This means that the PoC Server A has accepted the SIP REFER request and has started to process the request. This does not mean, however, that the PoC Client B (the referred-to resource) has been contacted.

5. SIP 202 "Accepted" response (from SIP/IP Core A to PoC Client A)

The SIP/IP Core A forwards the response to the PoC Client A.

6. SIP INVITE request (from PoC Server A towards PoC Client B)

The PoC Server A invites the PoC User, who is indicated in the Refer-To header of the received SIP REFER request.

Request-URI sip:PoC-UserB@networkB.net

SIP HEADERS

P-Asserted-Identity: "PoC User A" <sip:PoC-UserA@networkA.net>

Privacy Id

Accept-Contact: *;+g.poc.talkburst;require;explicit

User-Agent: PoC-serv/OMA2.0

Referred-By: "PoC User A" <sip:PoC-UserA@networkA.net>

Contact: <sip:SessionABCDEF@ PoC-ServerA.networkA.net;session1-1>;+g.poc.talkburst;isfocus

Supported: 100rel,timer,norefersub

Session-Expires: 1800

Allow: INVITE,ACK,CANCEL,BYE,PRACK,UPDATE,REFER,MESSAGE,OPTIONS

Reject-Contact: sip.automata;sip.actor=msg-taker;require;explicit

Reject-Contact: sip.automata;sip.actor=principal;sip.description="poc recording"

device";require;explicit

Content-Type: multipart/mixed

Subject: Let's talk

Alert-Info: <http://publicweb.networkB.net/users/PoC-UserA@networkA.net/myFavouriteRingingTone.wav>

Call-Info: <http://publicweb.networkB.net/users/PoC-UserA@networkA.net/myOwnPicture.jpg>;purpose=icon

SDP PARAMETERS

Content-Type: application/sdp

c= IN IP6 50555::ccc:ddd:aaa:bbb

a= poc-qoe:premium

m= audio 53456 RTP/AVP 97 98

a= rtpmap:97 AMR

a= rtpmap:98 EVRC/8000

a= rtcp:53080

i= speech

a= label:ll

a= a=upcc:0

m= Application 50000 udp TBCP

a= fmp: TBCP queuing=1; tb_priority=2; timestamp=1;multimedia=1;local_grant=1

a= floorid:0 mstrm:ll kk

m= video 7566 RTP/AVP 99

a= rtpmap:99 MP4V-ES

b= AS:75

a= label:kk

a= a=upcc:0

m= message 54321 TCP/MSRP *

a= accept-types:message/cpim application/vnd.oma.poc.final-report+xml
application/vnd.oma.poc.detailed-progress-report+xml
application/vnd.oma.poc.optimized-progress-report+xml

a= accept-wrapped-types:text/plain

a= path:msrp://[50555::ccc:ddd:aaa:bbb]:54321/ksdghfhafdga45sdf2a;tcp

a= max-size:100000000

Content-Type: text/directory;profile="vcard";charset=UTF-8

begin:vcard

fn:John P. Smith

n:Smith;John;Peter;Dr.;MBA

EMAIL:TYPE=internet:POC-UserB@networkA.net

version:3.0

end:vcard

7. SIP NOTIFY request (from PoC Server A to SIP/IP Core A)

The PoC Server A sends a SIP NOTIFY request via the SIP/IP Core A towards the PoC Client A to inform about the progress of the SIP REFER request processing. The body of the SIP NOTIFY request contains a fragment of the response as received by the notifying PoC Server A for the request that was initiated due to the SIP REFER request.

Request-URI sip:PoC-ClientA.networkA.net

SIP HEADERS

Event: refer

Subscription-State: active;expires=60

Content-Type: message/sipfrag

MIME BODY

SIP/2.0 100 TRYING

To: <sip:PoC-UserB@networkB.net>

8. SIP NOTIFY request (from SIP/IP Core A to PoC Client A)

The SIP/IP Core A forwards the SIP NOTIFY request to the PoC Client A.

Request-URI sip:PoC-ClientA.networkA.net

SIP HEADERS

Event: refer

Subscription-State: active;expires=60

Content-Type: message/sipfrag

MIME BODY

SIP/2.0 100 Trying

To: <sip:PoC-UserB@networkB.net>

9. SIP 200 "OK" response (from PoC Client A to SIP/IP Core A)

The PoC Client A acknowledges the SIP NOTIFY request with a SIP 200 "OK" response to the SIP/IP Core A.

10. SIP 200 "OK" response (from SIP/IP Core A to PoC Server A)

The SIP/IP Core A forwards the SIP 200 "OK" response to PoC Server A.

11. PoC Server A Receives Ringing Indication

PoC Server A receives a SIP 180 "Ringing" response.

12. SIP NOTIFY request (from PoC Server A to SIP/IP Core A)

The PoC Server A sends a SIP NOTIFY request that indicates that the PoC Client B is being alerted.

Request-URI sip:PoC-ClientA.networkA.net

SIP HEADERS

Event: refer

Subscription-State: active;expires=60

Content-Type: message/sipfrag

MIME BODY

SIP/2.0 180 Ringing

To: <sip:PoC-UserB@networkB.net>

P-Asserted-Identity: "PoC User B" <sip:PoC-UserB@networkB.net>

Contact: <sip:PoC-ServerB.networkB.net;b2bua>;+g.poc.talkburst;+g.poc.fdcfo

13. SIP NOTIFY request (from SIP/IP Core A to PoC Client A)

The SIP/IP Core A forwards the SIP NOTIFY request to the PoC Client A.

Request-URI sip:PoC-ClientA.networkA.net

SIP HEADERS

Event: refer
Subscription-State: active;expires=60
Content-Type: message/sipfrag

MIME BODY

SIP/2.0 180 Ringing

To: <sip:PoC-UserB@networkB.net>
P-Asserted-Identity: "PoC User B" <sip:PoC-UserB@networkB.net>
Contact: <sip:PoC-ServerB.networkB.net;b2bua>;+g.poc.talkburst;+g.poc.fdcfo

14. SIP 200 "OK" response (from PoC Client A to SIP/IP Core A)

The PoC Client A acknowledges the SIP NOTIFY request with a SIP 200 "OK" response to the SIP/IP Core A.

15. SIP 200 "OK" response (from SIP/IP Core A to PoC Server A)

The SIP/IP Core A forwards the SIP 200 "OK" response to the PoC Server A.

16. Referred PoC User accepts the invitation to the PoC Session

The invitation sent towards the referred PoC User has been accepted and the PoC Client B has joined the PoC Session.

A. MBCP Connect message (PoC Server A to PoC Client A)

In order to inform e.g PoC Session Identity of the established PoC Session the PoC Server A sends the MBCP Connect message to the PoC Client A.

B MBCP Media Burst Acknowledgement (PoC Client A to PoC Server A)

The PoC Client A acknowledges the reception of the MBCP Connect message.

17. SIP NOTIFY request (from PoC Server A to SIP/IP Core A)

The PoC Server A sends a SIP NOTIFY request that indicates that the PoC Client B is available and capable of receiving Media Streams.

Request-URI sip:PoC-ClientA.networkA.net

SIP HEADERS

Event: refer
Subscription-State: terminated
Content-Type: message/sipfrag

MIME BODY

SIP/2.0 200 OK

To: <sip:PoC-UserB@networkB.net>
 P-Asserted-Identity: "PoC User B" <sip:PoC-UserB@networkB.net>
 Contact: <sip:PoC-ServerB.networkB.net;b2bua>;+g.poc.talkburst;+g.poc.fdcfo

18. SIP NOTIFY request (from SIP/IP Core A to PoC Client A)

The SIP/IP Core A forwards the SIP NOTIFY request to the PoC Client A.

Request-URI sip:PoC-ClientA.networkA.net

SIP HEADERS

Event: refer
Subscription-State: terminated
Content-Type: message/sipfrag

MIME BODY

SIP/2.0 200 OK

To: <sip:PoC-UserB@networkB.net>
 P-Asserted-Identity: "PoC User B" <sip:PoC-UserB@networkB.net>
 Contact: <sip:PoC-ServerB.networkB.net;b2bua>;+g.poc.talkburst;+g.poc.fdcfo

19. SIP 200 "OK" response (from PoC Client A to SIP/IP Core A)

The PoC Client A acknowledges the SIP NOTIFY request with a SIP 200 "OK" response to the SIP/IP Core A.

20. SIP 200 "OK" response (from SIP/IP Core A to PoC Server A)

The SIP/IP Core A forwards the SIP 200 "OK" response to the PoC Server A.

F.3.2 Terminating flow

NOTE: Manual answer using a Pre-established Session is not supported in this version of the PoC Enabler. Manual answer using an On-demand Session is described in the subclause F.5.1 "*Terminating flow – Manual Answer*".

F.3.3 Originating flow - Unconfirmed Indication

PoC Client A invites PoC Client B to a PoC Session by sending a SIP REFER request to the PoC Server. PoC Client A has created a Pre-established Session as shown in Figure 4 "PoC Client initiates a Pre-established Session", and the PoC Client A has learned the URI that identifies this Session. This flow is as shown in Figure 6 "PoC Client A invites another PoC user to a Pre-established Session by sending a SIP REFER request to PoC Server A unconfirmed case".

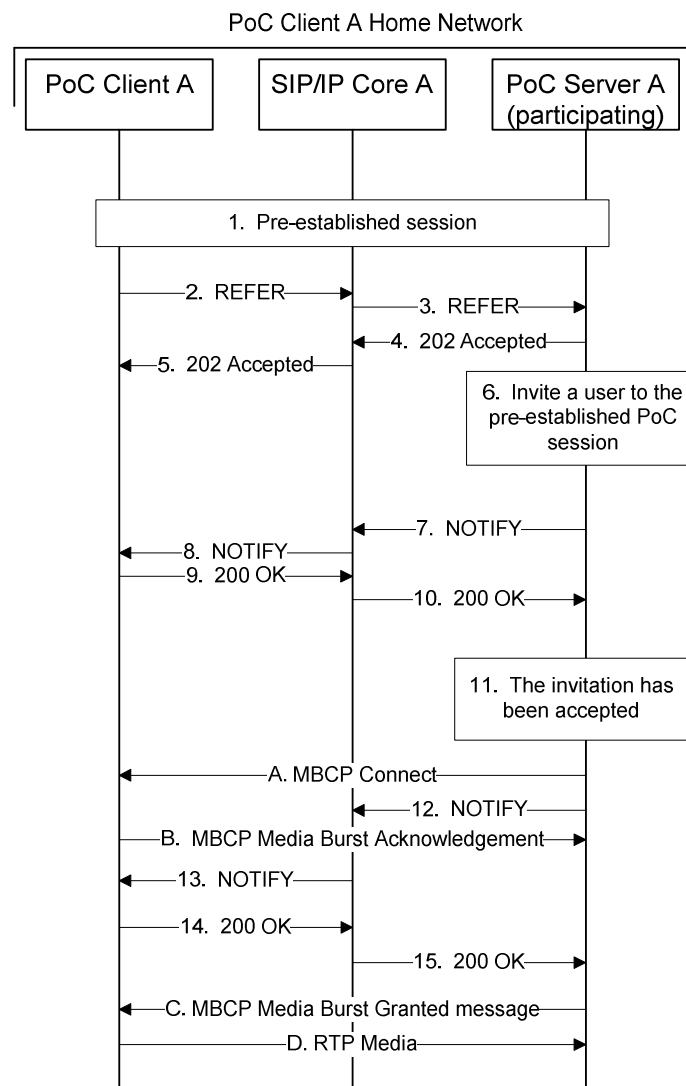

Figure 6: PoC Client A invites another PoC User to a Pre-established Session by sending a SIP REFER request to PoC Server A unconfirmed case

The steps of the flows are as follows:

1. PoC Client A creates a Pre-established Session

PoC Client A creates a Pre-established Session and learns its URI as shown in Figure 4 "PoC Client initiates a Pre-established Session".

2. SIP REFER request (from PoC Client A to SIP/IP Core A)

The PoC Client A invites the PoC Client B to the Pre-established Session.

Request-URI sip:Pre-establishedSessionIdentityA@PoC-ServerA.networkA.net

SIP HEADERS

Refer-To: <sip:PoC-UserB@networkB.net?Reject-Contact=sip.automata%3bsip.actor%3dmsg-taker%3brequire%3bexplicit&Reject-Contact=sip.automata%3bsip.actor%3dprincipal%3bsip.description%3d%22poc%20recording%20device%22%3brequire%3bexplicit&Priv-Answer-Mode=Auto>

Privacy: id

NOTE: For a 1-1 PoC Session the SIP REFER request does not contain a body.

3. SIP REFER request (from SIP/IP Core A to PoC Server A)

The SIP/IP Core A forwards the SIP REFER request to the PoC Server A performing the Participating PoC Function of the PoC Client A according to the SIP/IP Core A routing principles.

Request-URI sip:Pre-establishedSessionIdentityA@PoC-ServerA.networkA.net

SIP HEADERS

Refer-To: <sip:PoC-UserB@networkB.net?Reject-Contact=sip.automata%3bsip.actor%3dmsg-taker%3brequire%3bexplicit&Reject-Contact=sip.automata%3bsip.actor%3dprincipal%3bsip.description%3d%22poc%20recording%20device%22%3brequire%3bexplicit&Priv-Answer-Mode=Auto>

Privacy: id

4. SIP 202 "Accepted" response (from PoC Server A to SIP/IP Core A)

The PoC Server A indicates that it has received the SIP REFER request by sending a SIP 202 "Accepted" response. This means that the PoC Server A has accepted the SIP REFER request and has started to process the request. This does not mean, however, that the PoC Client B (the referred-to resource) has been contacted.

5. SIP 202 "Accepted" response (from SIP/IP Core A to PoC Client A)

The SIP/IP Core A forwards the response to the PoC Client A.

6. SIP INVITE request (from PoC Server A towards PoC Client B)

The PoC Server A invites the PoC User, who is indicated in the Refer-To header of the received SIP REFER request.

Request-URI sip:PoC-UserB@networkB.net

SIP HEADERS

P-Asserted-Identity: "PoC User A" <sip:PoC-UserA@networkA.net>
Accept-Contact: *,+g.poc.talkburst;require;explicit
User-Agent: PoC-serv/OMA2.0
Privacy: id
Referred-By: "PoC User A" <sip:PoC-UserA@networkA.net>
Contact: <sip:PoC-SessionABCDEF@PoC-ServerA.networkA.net;session=1-1>;+g.poc.talkburst;isfocus
Supported: 100rel,timer,norefersub
Session-Expires: 1800
Allow: INVITE,ACK,CANCEL,BYE,PRACK,UPDATE,REFER,MESSAGE,OPTIONS
Priv-Answer-Mode: Auto
Reject-Contact: sip.automata;sip.actor=msg-taker;require;explicit
Reject-Contact: sip.automata;sip.actor=principal;sip.description="poc recording device";require;explicit
Content-Type: application/sdp

SDP PARAMETERS

c= IN IP6 50555::ccc:ddd:aaa:bbb
a= poc-qoe:premium
m= audio 53456 RTP/AVP 97 98
a= rtpmap:97 AMR
a= rtpmap:98 EVRC/8000
a= rtcp:53080
i= speech
a= label:ll
a= a=upcc:0
m= Application 50000 udp TBCP
a= fmp: TBCP queuing=1; tb_priority=2; timestamp=1;multimedia=1;local_grant=1
a= floorid:0 mstrm:ll kk
m= video 17566 RTP/AVP 99
a= rtpmap:99 MP4V-ES
b= AS:75

a= label:kk
a= a=upcc:0
m= message 4321 TCP/MSRP *
a= accept-types:message/cpim application/vnd.oma.poc.final-report+xml
 application/vnd.oma.poc.detailed-progress-report+xml
 application/vnd.oma.poc.optimized-progress-report+xml
a= accept-wrapped-types:text/plain
a= path:msrp://[50555::ccc:ddd:aaa:bbb]:4321/ksdgfjhafdga45sdf2a;tcp
a= max-size:100000000

7. SIP NOTIFY request (from PoC Server A to SIP/IP Core A)

The PoC Server A sends a SIP NOTIFY request via the SIP/IP Core A towards the PoC Client A to inform about the progress of the SIP REFER request processing. The body of the SIP NOTIFY request contains a fragment of the response as received by the notifying PoC Server A for the request that was initiated due to the SIP REFER request.

Request-URI sip:PoC-ClientA.networkA.net

SIP HEADERS

Event: refer
Subscription-State: active;expires=60
Content-Type: message/sipfrag

MIME BODY

SIP/2.0 100 TRYING
To: <sip:PoC-UserB@networkB.net>

8. SIP NOTIFY request (from SIP/IP Core A to PoC Client A)

The SIP/IP Core A forwards the SIP NOTIFY request to the PoC Client A.

Request-URI sip:PoC-ClientA.networkA.net

SIP HEADERS

Event: refer
Subscription-State: active;expires=60

Content-Type: message/sipfrag

MIME BODY

SIP/2.0 100 TRYING

To: <sip:PoC-UserB@networkB.net>

9. SIP 200 "OK" response (from PoC Client A to SIP/IP Core A)

The PoC Client A acknowledges the SIP NOTIFY request with a SIP 200 "OK" response to the SIP/IP Core A.

10. SIP 200 "OK" response (from SIP/IP Core A to PoC Server A)

The SIP/IP Core A forwards the SIP 200 "OK" response to PoC Server A.

11. Invited PoC User accepts the invitation to the PoC Session

The invitation sent towards the referred PoC User has been accepted and the PoC Client B has joined the PoC Session.

A. MBCP Connect message (PoC Server A to PoC Client A)

The PoC A Server sends the MBCP Connect message to the PoC Client A.

12. SIP NOTIFY request (from PoC Server A to SIP/IP Core A)

The PoC Server A sends a SIP NOTIFY request that indicates that the PoC Client B is available and capable of receiving Media Streams.

Request-URI sip:PoC-ClientA.networkA.net

SIP HEADERS

Event: refer

Subscription-State: terminated

Content-Type: message/sipfrag

MIME BODY

SIP/2.0 200 OK

To: <sip:PoC-UserB@networkB.net>

P-Asserted-Identity "PoC User B" <sip:PoC-UserB@networkB.net>

Contact: <sip:PoC-ServerB.networkB.net;b2bua>;+g.poc.talkburst;+g.poc.fdcfo

P-Answer-State: Unconfirmed

B. MBCP Media Burst Acknowledgement (PoC Client A to PoC Server A)

The PoC Client A acknowledges the reception of the MBCP Connect message.

13. SIP NOTIFY request (from SIP/IP Core A to PoC Client A)

The SIP/IP Core A forwards the SIP NOTIFY request to the PoC Client A.

Request-URI sip:PoC-ClientA.networkA.net

SIP HEADERS

Event: refer

Subscription-State: terminated

Content-Type: message/sipfrag

MIME BODY

SIP/2.0 200 OK

To: <sip:PoC-UserB@networkB.net>

P-Asserted-Identity "PoC User B" <sip:PoC-UserB@networkB.net>

Contact: <sip:PoC-ServerB.networkB.net;b2bua>;+g.poc.talkburst;+g.poc.fdcfo

P-Answer-State: Unconfirmed

14. SIP 200 "OK" response (from PoC Client A to SIP/IP Core A)

The PoC Client A acknowledges the SIP NOTIFY request with a SIP 200 "OK" response to the SIP/IP Core A.

15. SIP 200 "OK" response (from SIP/IP Core A to PoC Server A)

The SIP/IP Core A forwards the SIP 200 "OK" response to the PoC Server A.

C. MBCP Media Burst Granted message (from PoC Server A to PoC Client A)

The PoC Server X sends a MBCP Media Burst Granted message to the PoC Server A.

D. RTP Media from PoC Client A to PoC Server A

The PoC Client A sends the RTP Media to the PoC Server A.

F.3.4 Terminating flow – Unconfirmed Indication

PoC Server X invites the PoC Client B to a PoC Session by sending a SIP INVITE request to the terminating SIP/IP Core. The PoC Client B has created a Pre-established Session as shown in Figure 4 "*PoC Client A initiates a Pre-established Session*".

QoE Profiles feature is used in this flow. Premium QoE Profile is assigned to the PoC Session and PoC Client B also created the Pre-established Session using Premium QoE Profile. PoC Client B participates in the PoC Session with Premium Local QoE Profile.

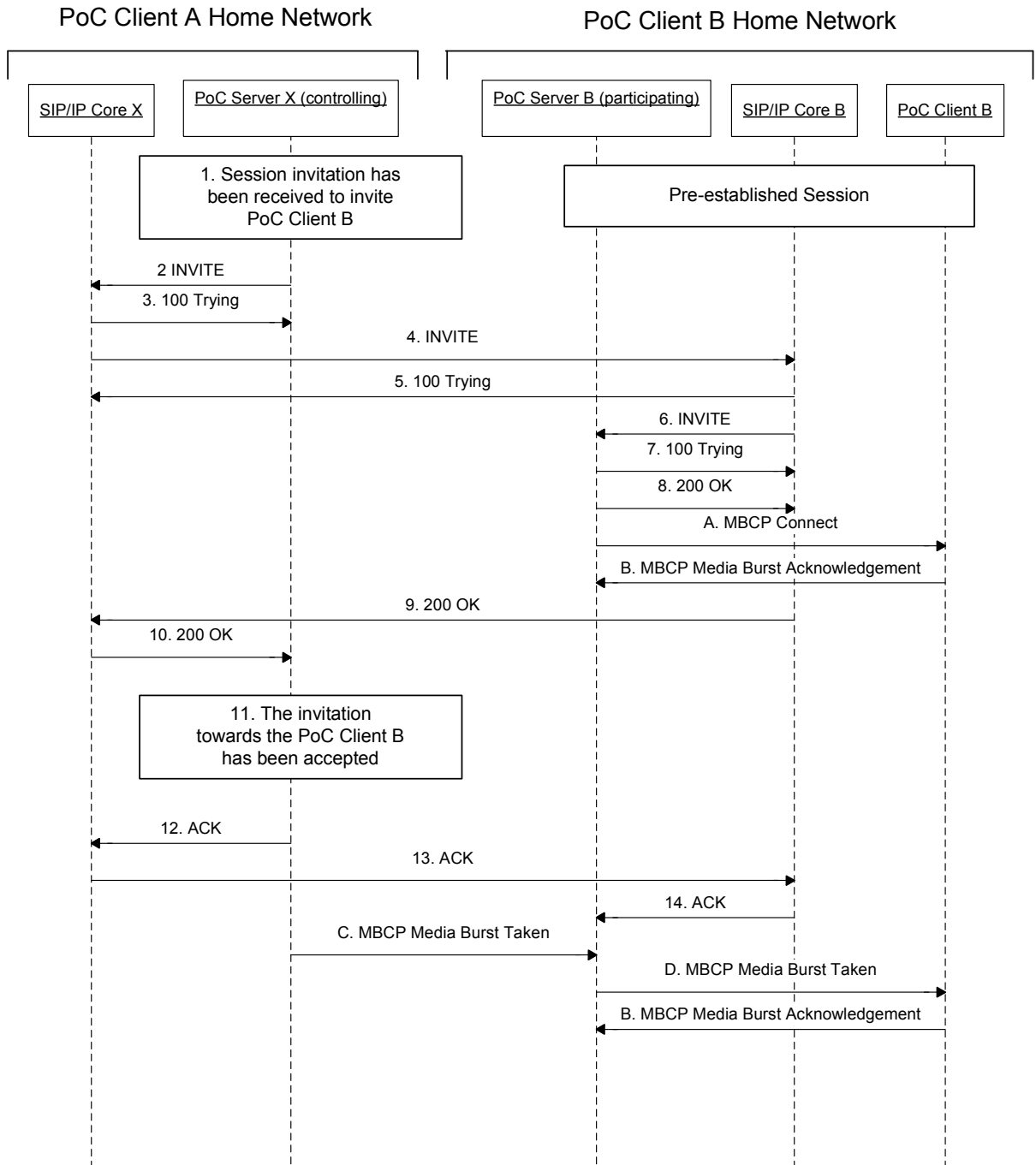

Figure 7: PoC Session invitation with automatic answer – Pre-established Session case.

This flow shows a PoC Server X inviting a PoC User to a PoC Session. The flow is as shown in Figure 7 "PoC Session invitation with automatic answer – Pre-established Session case". The invitation may be as a result of another PoC User sending a SIP REFER request to the PoC Server X as shown in Figure 6 "PoC Client A invites another user to a Pre-established Session by sending a SIP REFER request to PoC Server A unconfirmed case". Note that the PoC Server A as shown in Figure 6 "PoC Client A invites another user to a Pre-established Session by sending a SIP REFER request to PoC Server A unconfirmed case " has changed its role and acts as the PoC Server X in this flow.

The steps of the flows are as follows:

1. Session Invitation has been received to invite PoC Client B
2. SIP INVITE request (PoC Server X to SIP/IP Core X)

The PoC Server X invites the PoC Client B to a PoC Session. This may happen as a result of another PoC User referring the PoC Client B to the PoC Server X. The PoC Server X sends a SIP INVITE request via the SIP/IP Core X to the PoC Client B home network. The SIP INVITE request contains an SDP offer with the media information (e.g IP address and port number(s)) of the PoC Server X) and the Media Burst Control Protocol. In this example PoC Server X supports and offers both the AMR and EVRC codecs.

Request-URI sip:PoC-UserB@networkB.net

SIP HEADERS

P-Asserted-Identity: "PoC User A" <sip:PoC-UserA@networkA.net>

Accept-Contact: *,+g.poc.talkburst; require;explicit

User-Agent: PoC-serv/OMA2.0

Privacy: id

Referred-By: "PoC User A" <sip:PoC-UserA@networkA.net>

Contact: <sip: PoC-SessionABCDEF@PoC-ServerX.networkX.net; session=1-1>;+g.poc.talkburst;isfocus

Supported: 100rel,norefersub,timer

Session-Expires: 1800

Allow: INVITE,ACK,CANCEL,BYE,PRACK,UPDATE,REFER,MESSAGE,OPTIONS

Priv-Answer-Mode: Auto

Reject-Contact: sip.automata;sip.actor=msg-taker;require;explicit

Reject-Contact: sip.automata;sip.actor=principal;sip.description="poc recording device";require;explicit

Content-Type: application/sdp

SDP PARAMETERS

c= IN IP6 50555::ccc:ddd:aaa:bbb

a= poc-qoe:premium

```

m=          audio 53456 RTP/AVP 97 98
a=          rtpmap:97 AMR
a=          rtpmap:98 EVRC/8000
a=          rtcp:53080
i=          speech
a=          label:ll
a=          a=upcc:0
m=          Application 50000 udp TBCP
a=          fmtp:TBCP queuing=1; tb_priority=2; timestamp=1;multimedia=1;local_grant=1
a=          floorid:0 mstrm:ll kk
m=          video 17566 RTP/AVP 99
a=          rtpmap:99 MP4V-ES
b=          AS:75
a=          label:kk
a=          a=upcc:0
m=          message 4321 TCP/MSRP *
a=          accept-types:message/cpim application/vnd.oma.poc.final-report+xml
            application/vnd.oma.poc.detailed-progress-report+xml
            application/vnd.oma.poc.optimized-progress-report+xml
a=          accept-wrapped-types:text/plain
a=          path:msrp://[50555::ccc:ddd:aaa:bbb]:4321/ksdgfjhafdga45sdf2a;tcp
a=          max-size:100000000

```

3. SIP 100 "Trying" response (SIP/IP Core X to PoC Server X)

The SIP/IP Core X responds to the SIP INVITE request with a SIP 100 "Trying" provisional response.

4. SIP INVITE request (SIP/IP Core X to SIP/IP Core B)

The SIP/IP Core X resolves the SIP/IP Core B address of the PoC Client B and forwards the SIP INVITE request to the SIP/IP Core B. The SIP INVITE request contains the same PoC specific elements as the SIP INVITE request sent by PoC Server X to SIP/IP Core X.

5. SIP 100 "Trying" response (SIP/IP Core B to SIP/IP Core X)

The SIP/IP Core B responds to the SIP INVITE request with a SIP 100 "Trying" provisional response.

6. SIP INVITE request (SIP/IP Core B to PoC Server B)

The SIP/IP Core B forwards the SIP INVITE request to the PoC Server B. The SIP INVITE request contains the same PoC specific elements as the SIP INVITE request sent by PoC Server X to SIP/IP Core X.

7. SIP 100 "Trying" response (PoC Server B to SIP/IP Core B)

The PoC Server B responds to the SIP INVITE request with a SIP 100 "Trying" provisional response.

8. SIP 200 "OK" response (PoC Server B to SIP/IP Core B)

The PoC Server B receives the SIP INVITE request, identifies that auto answer is defined for the PoC Client B and that the PoC Client B has already a Pre-established Session established. Therefore the PoC Server B sends a SIP 200 "OK" final response to the SIP INVITE request to the SIP/IP Core B. The SIP 200 "OK" response is sent along the signalling path. The SIP 200 "OK" response contains the SDP answer including the accepted media information (e.g. Codecs, IP address and port number(s) of the PoC Server B) and accepted Media Burst Control Protocol. In this example PoC Server B knows that PoC Client B only supports the EVRC codec and so only returns EVRC in the SDP answer and PoC Server B uses the same port for RTCP and the Media Burst Control Protocol.

SIP HEADERS

P-Asserted-Identity: "PoC User B" <sip:PoC-UserB.networkB.net>
Require: timer
Server: PoC-serv/OMA2.0
Contact: <sip:PoC-ServerB@networkB.net;b2bua >;+g.poc.talkburst;+g.poc.fdcfo
Session-Expires: 1800;refresher=uas
P-Answer-State: Unconfirmed
Allow: INVITE,ACK,CANCEL,BYE,PRACK,UPDATE,MESSAGE,OPTIONS
Accept-Language: en
Content-Type: application/sdp

SDP PARAMETERS

c= IN IP6 99055::fff:aaa:eee:bbb
a= poc-qoe:premium
m= audio 59006 RTP/AVP 98
a= rtpmap:98 EVRC/8000
a= rtcp:50000
i= speech
a= label:uu
a= a=upcc:0
m= application 50000 udp TBCP
a= fntp:TBCP queuing=1; tb_priority=2; timestamp=1;multimedia=1;local_grant=1
a= floorid:0 mstrm:uu vv
m= video 17566 RTP/AVP 99

```

a=          rtpmap:99 MP4V-ES
b=          AS:75
a=          label:vv
a=          a=upcc:0
m=          message 43821 TCP/MSRP *
a=          accept-types:message/cpim application/vnd.oma.poc.final-report+xml
            application/vnd.oma.poc.detailed-progress-report+xml
            application/vnd.oma.poc.optimized-progress-report+xml
a=          accept-wrapped-types:text/plain
a=          path:msrp://[99055::fff:aaa:eee:bbb]:43821/xk83a45;tcp
a=          max-size:10000

```

A. MBCP Connect message (PoC Server B to PoC Client B)

In order to inform about the invitation to a PoC Session the PoC Server B sends the MBCP Connect to the PoC Client B. The message includes the PoC Session Identity.

B. MBCP Media Burst Acknowledgement (PoC Client B to PoC Server)

The PoC Client B acknowledges the reception of the MBCP Connect message.

9. SIP 200 "OK" response (SIP/IP Core B to SIP/IP Core X)

The SIP/IP Core B forwards the SIP 200 "OK" final response to the SIP/IP Core X. The SIP 200 "OK" response contains the same PoC specific elements as the SIP 200 "OK" response sent by PoC Server B to SIP/IP Core B.

10. SIP 200 "OK" response (SIP/IP Core X to PoC Server X)

The SIP/IP Core X forwards the SIP 200 "OK" response to the PoC Server X. The SIP 200 "OK" response contains the same PoC specific elements as the SIP 200 "OK" response sent by PoC Server B to SIP/IP Core B.

11. The invitation towards the PoC Client B has been accepted

The PoC Server X sends a notification towards the PoC Client A that the Invited PoC User is available and capable of receiving the Media Streams.

12. SIP ACK request (PoC Server X to SIP/IP Core X)

The PoC Server X acknowledges the SIP 200 "OK" response with a SIP ACK request sent to the SIP/IP Core X.

13. SIP ACK request (SIP/IP Core X to SIP/IP Core B)

The SIP/IP Core X forwards the SIP ACK request to the SIP/IP Core B.

14. SIP ACK request (SIP/IP Core B to PoC Server B)

The SIP/IP Core B forwards the SIP ACK request to the PoC Server B.

C. MBCP Media Burst Taken (PoC Server X to PoC Server B)

The PoC Server X sends the MBCP Media Burst Taken to the PoC Server B. Unless privacy is required the MBCP Media Burst Taken message includes the Sender Identity.

D. MBCP Media Burst Taken (PoC Server B to PoC Client B)

The PoC Server B sends the MBCP Media Burst Taken to the PoC Client B. Unless privacy is required the MBCP Media Burst Taken message includes the Sender Identity The PoC Server B includes a request to acknowledge the message.

E. MBCP Media Burst Acknowledgement message (PoC Client B to PoC Server B)

The PoC Client B acknowledges the reception of the MBCP Media Burst Taken message.

F.4 Ad-hoc and 1-1 PoC Session establishment On-demand Session

F.4.1 Originating flow – Unconfirmed Indication

The signaling sequences in this subclause show the establishment of the Ad-hoc PoC Session using on-demand signaling in the originating side. As a prerequisite for the on-demand signaling, PoC Client needs to be registered.

This flow shows the signaling sequence for the unconfirmed case. In this case a SIP 183 "Session Progress" response is received from the terminating side before a SIP 200 "OK" response is sent, PoC Server performing the Controlling PoC Function sends a SIP 200 "OK" response to the PoC Client. In this flow the media buffering is supported and the MBCP Media Burst Granted is sent after the SIP 183 "Session Progress" is received. If buffering is not supported the MBCP Media Burst Granted is sent after the SIP 200 "OK" is received.

QoE Profiles feature is used in this flow. PoC Client A requests Premium QoE Profile for the PoC Session and for his Local QoE Profile.

The flow is as shown in Figure 8 "*Ad-hoc PoC Session establishment on the originating side using on-demand signaling, unconfirmed case*".

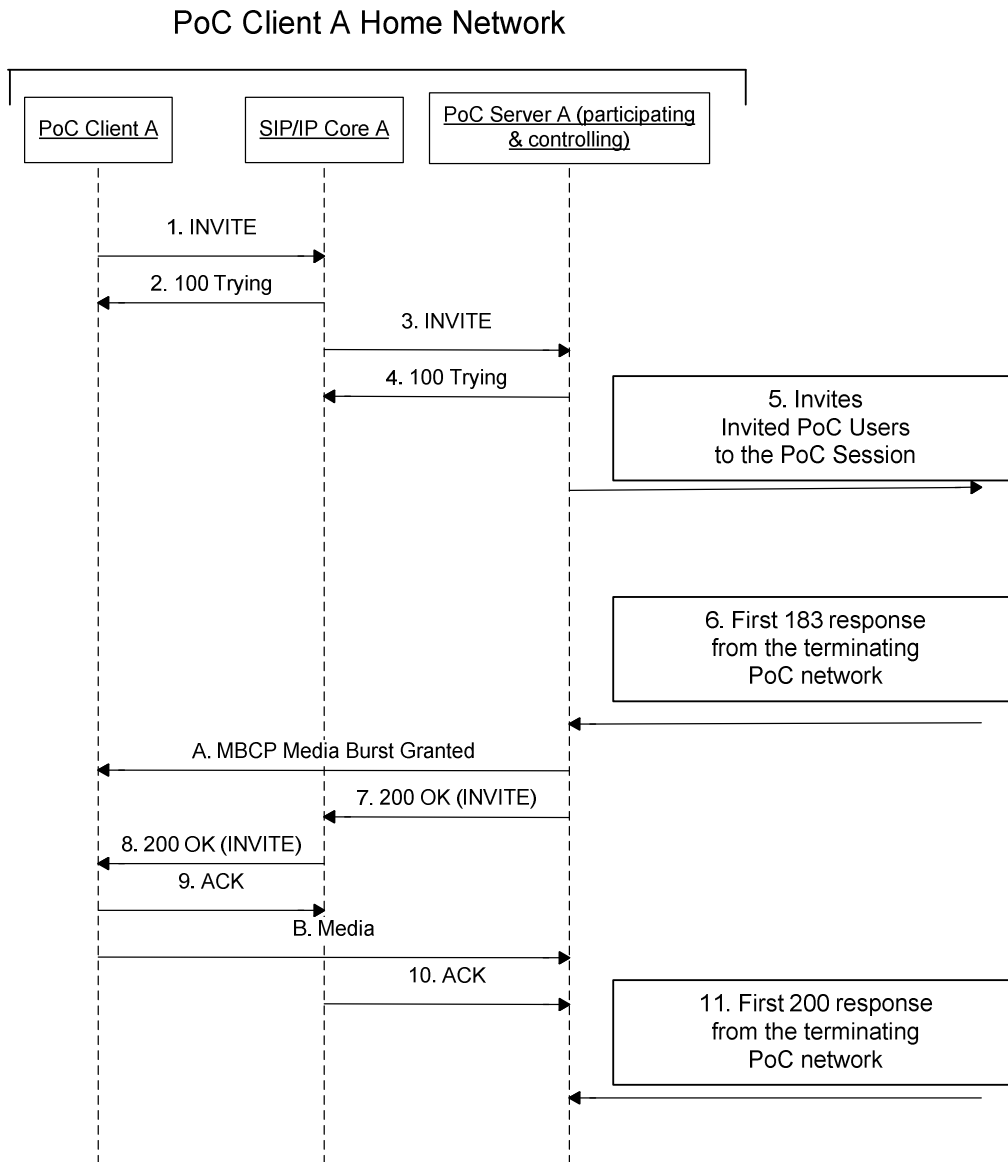

Figure 8: Ad-hoc PoC Session establishment on the originating side using on-demand signaling, unconfirmed case

The steps of the flow are as follows:

1. SIP INVITE request (from PoC Client A to SIP/IP Core A)

The PoC Client A sends a SIP INVITE request to the SIP/IP Core A.

Request-URI sip:PoCConferenceFactoryURI.networkA.net

SIP HEADERS

P-Preferred-Identity: "PoC User A" <sip:PoC-UserA@networkA.net>
Accept-Contact: *,+g.poc.talkburst; require;explicit
User-Agent: PoC-client/OMA2.0 Acme-Talk5000/v1.01
Privacy: id
Contact: <sip:PoC-ClientA.networkA.net>;+sip.instance="<urn:uuid:00000000-0000-1000-8000-000A95A0E128>";+g.poc.talkburst;+g.poc.fdcfo;+g.poc.discretemedia
Supported: timer
Session-Expires: 1800
Allow: INVITE,ACK,CANCEL,BYE,REFER,OPTIONS,MESSAGE
Content-Type: multipart/mixed
Require: recipient-list-invite
Priv-Answer-Mode: Auto
Accept-Language: en
Subject: Let's talk
Alert-Info: <http://publicweb.networkB.net/users/PoC-UserA@networkA.net/myFavouriteRingtone.wav>
Call-Info: <http://publicweb.networkB.net/users/PoC-UserA@networkA.net/myOwnPicture.jpg>;purpose=icon
Reject-Contact: sip.automata;sip.actor=msg-taker;require;explicit
Reject-Contact: sip.automata;sip.actor=principal;sip.description="poc recording device";require;explicit

SDP PARAMETERS

Content-Type: application/sdp

c= IN IP6 5555::aaa:bbb:ccc:ddd
a= poc-qoe:premium
m= audio 3456 RTP/AVP 97
a= rtpmap:97 AMR
a= rtcp:5560
i= speech
b= AS:25.4

a= label:aa
 m= application 2000 udp TBCP
 a= fmp: TBCP queuing=1; tb_priority=2;
 timestamp=1;multimedia=1;local_grant=1;imp_mb_req=1
 a= floorid:0 mstrm:aa bb
 m= video 5678 RTP/AVP 99
 a= rtpmap:99 MP4V-ES
 b= AS:75
 a= label:bb
 m= message 12345 TCP/MSRP *
 a= accept-types:message/cpim application/vnd.oma.poc.final-report+xml
 application/vnd.oma.poc.detailed-progress-report+xml
 application/vnd.oma.poc.optimized-progress-report+xml
 a= accept-wrapped-types:text/plain
 a= path:msrp://[5555::aaa:bbb:ccc:ddd]:12345/kjhd37s2s20w2a;tcp
 a= max-size:10000

XML MIME BODY

Content-Type: application/resource-lists+xml

Content-Disposition: recipient-list

```
<?xml version="1.0" encoding="UTF-8"?>
```

```

<resource-lists xmlns="urn:ietf:params:xml:ns:resource-lists"
  xmlns:xsi="http://www.w3.org/2001/XMLSchema-instance"
  xmlns:cc="urn:ietf:params:xml:ns:copycontrol"

```

```
>
```

```
<list>
```

```

  <entry uri="sip:PoC-UserB@networkB.com" cc:copyControl="to"
  cc:anonymize="true"/>

```

```

  <entry uri="sip:PoC-UserC@networkC.com;uriusage=user"
  cc:copyControl="to" cc:anonymize="true"/>

```

```

    <entry uri="sip:PoC-UserD@networkD.com" cc:copyControl="to"
cc:anonymize="false"/>
  </list>
</resource-lists>

```

Included Media Content

Content-Type: text/directory;profile="vcard";charset=UTF-8

```

begin:vcard
fn:John P. Smith
n:Smith;John;Peter;Dr.;MBA
EMAIL:TYPE=internet:POC-UserB@networkA.net
version:3.0
end:vcard

```

2. SIP 100 "Trying" response (from SIP/IP Core A to PoC Client A)

The SIP/IP Core A returns a SIP 100 "Trying" response.

3. SIP INVITE request (from SIP/IP Core A to PoC Server A)

The SIP/IP Core A forwards the SIP INVITE request to the PoC Server A.

Request-URI sip:PoCConferenceFactoryURI.networkA.net

SIP HEADERS

P-Asserted-Identity: "PoC User A" <sip:PoC-UserA@networkA.net>

Accept-Contact: *,+g.poc.talkburst; require;explicit

User-Agent: PoC-client/OMA2.0 Acme-Talk5000/v1.01

Privacy: id

Contact: <sip:PoC-ClientA.networkA.net>;+sip.instance="<urn:uuid:00000000-0000-1000-8000-000A95A0E128>";+g.poc.talkburst;+g.poc.fdcfo;+g.poc.discretedia

Supported: timer

Session-Expires: 1800

Allow: INVITE,ACK,CANCEL,BYE,REFER,OPTIONS,MESSAGE

Content-Type: multipart/mixed

Require: recipient-list-invite
Priv-Answer-Mode: Auto
Accept-Language: en
Subject: Let's talk
Alert-Info: <http://publicweb.networkB.net/users/PoC-UserA@networkA.net/myFavouriteRingingTone.wav>
Call-Info: <http://publicweb.networkB.net/users/PoC-UserA@networkA.net/myOwnPicture.jpg>;purpose=icon
Reject-Contact: sip.automata;sip.actor=msg-taker;require;explicit
Reject-Contact: sip.automata;sip.actor=principal;sip.description="poc recording device";require;explicit

SDP PARAMETERS

Content-Type: application/sdp

c= IN IP6 5555::aaa:bbb:ccc:ddd
a= poc-qoe:premium
m= audio 3456 RTP/AVP 97
a= rtpmap:97 AMR
a= rtcp:5560
i= speech
b= AS:25.4
a= label:aa
m= application 2000 udp TBCP
a= fntp:TBCP queuing=1; tb_priority=2; timestamp=1;multimedia=1;local_grant=1;imp_mb_req=1
a= floorid:0 mstrm:aa bb
m= video 5678 RTP/AVP 99
a= rtpmap:99 MP4V-ES
b= AS:75
a= label:bb
m= message 12345 TCP/MSRP *
a= accept-types:message/cpim application/vnd.oma.poc.final-report+xml

application/vnd.oma.poc.detailed-progress-report+xml
 application/vnd.oma.poc.optimized-progress-report+xml
a= accept-wrapped-types:text/plain
a= path:msrp://[5555::aaa:bbb:ccc:ddd]:12345/kjhd37s2s20w2a;tcp
a= max-size:10000

XML MIME BODY

Content-Type: application/resource-lists+xml

Content-Disposition: recipient-list

```

<?xml version="1.0" encoding="UTF-8"?>

<resource-lists xmlns="urn:ietf:params:xml:ns:resource-lists"
  xmlns:xsi="http://www.w3.org/2001/XMLSchema-instance"
  xmlns:cc="urn:ietf:params:xml:ns:copycontrol"
>
  <list>
    <entry uri="sip:PoC-UserB@networkB.com" cc:copyControl="to"
      cc:anonymize="true"/>
    <entry uri="sip:PoC-UserC@networkC.com;uriusage=user"
      cc:copyControl="to" cc:anonymize="true"/>
    <entry uri="sip:PoC-UserD@networkD.com" cc:copyControl="to"
      cc:anonymize="false"/>
  </list>
</resource-lists>

```

Included Media Content

Content-Type: text/directory;profile="vcard";charset=UTF-8

```

begin:vcard
fn:John P. Smith
n:Smith;John;Peter;Dr.;MBA

```

```
EMAIL:TYPE=internet:POC-UserB@networkA.net
version:3.0
end:vcard
```

4. SIP 100 "Trying" response (from PoC Server A to SIP/IP Core A)

The PoC Server A sends a SIP 100 "Trying" response to the SIP/IP Core A.

5. PoC Server A sends SIP INVITE requests towards the Invited PoC Clients

The PoC Server A sends SIP INVITE requests to the Invited PoC Clients as shown in Figure 11 "*PoC Session invitation with automatic answer*".

Request-URI sip:PoC-UserB@networkB.net

SIP HEADERS

P-Asserted-Identity: "PoC User A" <sip:PoC-UserA@networkA.net>

Accept-Contact: *,+g.poc.talkburst; require;explicit

User-Agent: PoC-serv/OMA2.0

Referred-By: "PoC User A" <sip:PoC-UserA@networkA.net>

Privacy: id

Contact: <sip:PoC-SessionABCDEF@PoC-ServerA.networkA.net;session=adhoc>;+g.poc.talkburst;isfocus;+g.poc.discretemedia

Supported: 100rel,timer,norefersub

Session-Expires: 1800

Allow: INVITE,ACK,CANCEL,BYE,PRACK,UPDATE,REFER,MESSAGE,OPTIONS

Priv-Answer-Mode: Auto

Subject: Let's talk

Alert-Info: <http://publicweb.networkB.net/users/PoC-UserA@networkA.net/myFavouriteRingtone.wav>

Call-Info: <http://publicweb.networkB.net/users/PoC-UserA@networkA.net/myOwnPicture.jpg>;purpose=icon

Reject-Contact: sip.automata;sip.actor=msg-taker;require;explicit

Reject-Contact: sip.automata;sip.actor=principal;sip.description="poc recording device";require;explicit

SDP PARAMETERS

Content-Type: application/sdp

c= IN IP6 50555::ccc:ddd:aaa:bbb
a= poc-qoe:premium
m= audio 53456 RTP/AVP 97 98
a= rtpmap:97 AMR
a= rtpmap:98 EVRC/8000
a= rtcp:53080
i= speech
a= label:ll
a= a=upcc:0
m= Application 50000 udp TBCP
a= fmp: TBCP queuing=1; tb_priority=2; timestamp=1;multimedia=1;local_grant=1
a= floorid:0 mstrm:ll kk
m= video 7566 RTP/AVP 99
a= rtpmap:99 MP4V-ES
a= label:kk
a= a=upcc:0
m= message 54321 TCP/MSRP *
a= accept-types:message/cpim application/vnd.oma.poc.final-report+xml
application/vnd.oma.poc.detailed-progress-report+xml
application/vnd.oma.poc.optimized-progress-report+xml
a= accept-wrapped-types:text/plain
a= path:msrp://[50555::ccc:ddd:aaa:bbb]:54321/ksdghafhdga45sdf2a;tcp
a= max-size:100000000

**Included Media
Content**

Content-Type: text/directory;profile="vcard";charset=UTF-8

begin:vcard
fn:John P. Smith
n:Smith;John;Peter;Dr.;MBA

```
EMAIL:TYPE=internet:POC-UserB@networkA.net
version:3.0
end:vcard
```

**Invited parties
identity information**

Content-Disposition: recipient-list-history;handling="optional"
Content-Type: application/resource-lists+xml

```
<?xml version="1.0" encoding="UTF-8"?>
<resource-lists
  xmlns="urn:ietf:params:xml:ns:resource-lists"
  xmlns:cc="urn:ietf:params:xml:ns:copycontrol"
>
  <list>
    <entry uri="sip:PoC-UserB@networkB.com" cc:copyControl="to"
cc:anonymize="true"/>
    <entry uri="sip:PoC-UserC@networkC.com;uriusage=user"
cc:copyControl="to" cc:anonymize="true"/>
    <entry uri="sip:PoC-UserD@networkD.com" cc:copyControl="to"
cc:anonymize="false"/>
  </list>
</resource-lists>
```

6. PoC Server A receives SIP 183 "Session Progress" response

The PoC Server A receives the first SIP 183 "Session Progress" response as shown in Figure 11 "*PoC Session invitation with automatic answer*".

SIP HEADERS

P-Asserted-Identity: "PoC User B" <sip:PoC-UserB@networkB.net>
Server: PoC-serv/OMA2.0
Contact: <sip:PoC-ServerB@networkBPoC-SessionABCDEF@PoC-ServerB.networkB.net>;+g.poc.talkburst
P-Answer-State: Unconfirmed
Allow: INVITE,ACK,CANCEL,BYE,PRACK,UPDATE,MESSAGE,OPTIONS

Require: 100rel

A. MBCP Media Burst Granted (PoC Server A to PoC Client A)

The PoC Server A sends MBCP Media Burst Granted message to PoC Client A. This step may occur before SIP ACK request or SIP 200 "OK," because the SIP 200 "OK" response travels through the SIP IP/Core, and the MBCP packet is sent directly from the PoC Server to the PoC Client.

7. SIP 200 "OK" response (from PoC Server A to SIP/IP Core A)

The PoC Server A sends a SIP 200 "OK" to SIP/IP Core A. (Optionally PoC Server A inserts Media Burst granted indication into the SIP 200 "OK" response).

SIP HEADERS

P-Asserted-Identity: <sip:PoCConferenceFactoryURI.networkA.net>
Server: PoC-serv/OMA2.0
Contact: <sip:PoC-SessionABCDEF@PoC-ServerA.networkA.net;session=adhoc>;+g.poc.talkburst;isfocus
Require: timer
Session-Expires: 1800;refresher=uac
P-Answer-State: Unconfirmed
Allow: INVITE,ACK,CANCEL,BYE,PRACK,UPDATE,REFER,MESSAGE,OPTIONS
Supported: norefersub
Content-Type: application/sdp

SDP PARAMETERS

c= IN IP6 57777::eee:fff:aaa:bbb
a= poc-qoe:premium
m= audio 57787 RTP/AVP 97
i= speech
a= label:xxx
a= rtpmap:97 AMR
a= rtcp:57000
m= application 57790 udp TBCP
a= fmp: TBCP queuing=1; tb_priority=2; timestamp=1;multimedia=1;local_grant=1;imp_mb_req=1
a= floorid:0 mstrm:xxx yyy

```

m=          video 23456 RTP/AVP 99
a=          rtpmap:99 MP4V-ES
a=          label:yyy
m=          message 34567 TCP/MSRP *
a=          accept-types:message/cpim application/vnd.oma.poc.final-report+xml
            application/vnd.oma.poc.detailed-progress-report+xml
            application/vnd.oma.poc.optimized-progress-report+xml
a=          accept-wrapped-types:text/plain
a=          path:msrp://[57777::eee:fff:aaa:bbb]:12345/jshA7weztas;tcp

```

8. SIP 200 "OK" response (from SIP/IP Core A to PoC Client A)

The SIP/IP Core A forwards the 200 "OK" response to PoC Client A

SIP HEADERS

```

P-Asserted-Identity:    <sip:PoCConferenceFactoryURI.networkA.net >
Server:                PoC-serv/OMA2.0
Contact:               <sip:PoC-SessionABCDEF@PoC-
                        ServerA.networkA.net;session=adhoc>;+g.poc.talkburst;isfocus
Require:               timer
Session-Expires:      1800;refresher=uac
P-Answer-State:       Unconfirmed
Allow:                 INVITE,ACK,CANCEL,BYE,PRACK,UPDATE,REFER,MESSAGE,OPTIONS
Supported:            norefersub
Content-Type:         application/sdp

```

SDP PARAMETERS

```

c=          IN IP6 57777::eee:fff:aaa:bbb
a=          poc-qoe:premium
m=          audio 57787 RTP/AVP 97
i=          speech
a=          label:xxx
a=          rtpmap:97 AMR
a=          rtcp:57000
m=          application 57790 udp TBCP

```

```

a=          fmtp:TBCP queuing=1; tb_priority=2;
           timestamp=1;multimedia=1;local_grant=1;imp_mb_req=1

a=          floorid:0 mstrm:xxx yyy

m=          video 23456 RTP/AVP 99

a=          rtpmap:99 MP4V-ES

a=          label:yyy

m=          message 34567 TCP/MSRP *

a=          accept-types:message/cpim application/vnd.oma.poc.final-report+xml
           application/vnd.oma.poc.detailed-progress-report+xml
           application/vnd.oma.poc.optimized-progress-report+xml

a=          accept-wrapped-types:text/plain

a=          path:msrp://[57777::eee:fff:aaa:bbb]:12345/jshA7weztas;tcp

```

9. SIP ACK request (from PoC Client A to SIP/IP Core A)

The PoC Client A sends a SIP ACK request to SIP/IP Core A

10. SIP ACK request (from SIP/IP Core A to PoC Server A)

The SIP/IP Core A forwards the SIP ACK request to PoC Server A

B. PoC Client sends RTP Media to PoC Server A

The PoC Client A sends RTP Media packets to PoC Server A

F.4.2 Originating flow – Confirmed Indication with manual answer

The signaling sequences in this subclause show the establishment of the 1-1 PoC Session using on-demand signaling in the originating side. As a prerequisite for the on-demand signaling, PoC Client needs to be registered.

This flow shows the signaling sequence for the Confirmed indication case when the terminating side answers manually and SIP 200 "OK" is not sent before the SIP 200 "OK" from the terminating side is received.

QoE Profiles feature is used in this flow. PoC Client A requests Professional QoE Profile for the PoC Session and for his Local QoE Profile.

The flow is as shown in Figure 9 *"Ad-hoc PoC Session establishment on the originating side using on-demand signaling, confirmed case manual answer"*.

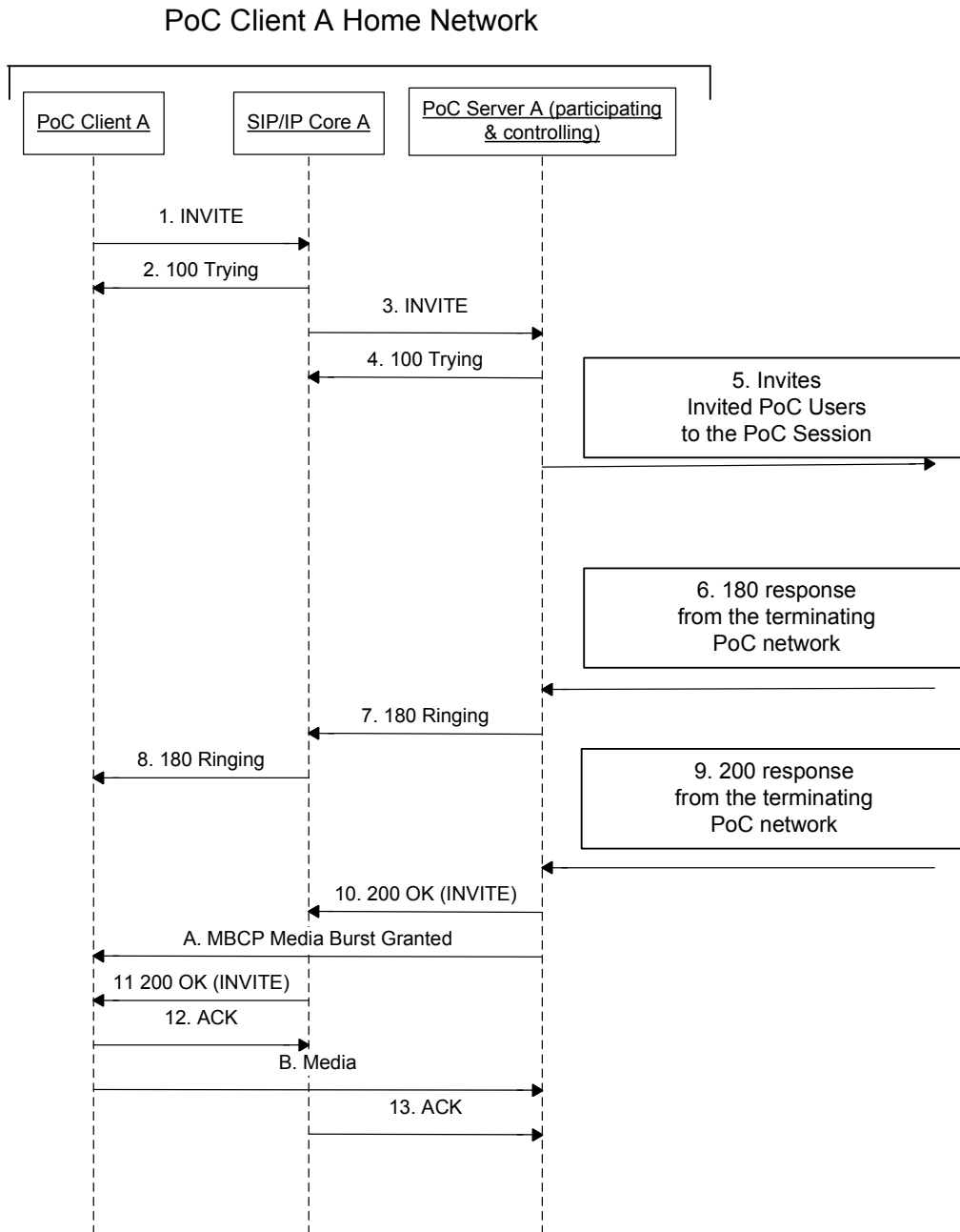

Figure 9: Ad-hoc PoC Session establishment on the originating side using on-demand signaling, confirmed case manual answer

The steps of the flow are as follows:

1. SIP INVITE request (from PoC Client A to SIP/IP Core A)

The PoC Client A sends a SIP INVITE request to SIP/IP Core A.

Request-URI sip:PoCConferenceFactoryURI.networkA.net

SIP HEADERS

P-Preferred-Identity: "PoC User A" <sip:PoC-UserA@networkA.net>

Accept-Contact: *;+g.poc.talkburst; require;explicit

User-Agent: PoC-client/OMA2.0 Acme-Talk5000/v1.01

Privacy: id

Contact: <sip:PoC-ClientA.networkA.net>;+sip.instance="<urn:uuid:00000000-0000-1000-8000-000A95A0E128>";+g.poc.talkburst;+g.poc.fdcfo;+g.poc.discretemedia

Supported: Timer

Session-Expires: 1800

Allow: INVITE,ACK,CANCEL,BYE,REFER,OPTIONS,MESSAGE

Require: recipient-list-invite

Content-Type: multipart/mixed

Accept-Language: en

Subject: Let's talk

Alert-Info: <http://publicweb.networkB.net/users/PoC-UserA@networkA.net/myFavouriteRingtone.wav>

Call-Info: <http://publicweb.networkB.net/users/PoC-UserA@networkA.net/myOwnPicture.jpg>;purpose=icon

Reject-Contact: sip.automata;sip.actor=msg-taker;require;explicit

Reject-Contact: sip.automata;sip.actor=principal;sip.description="poc recording device";require;explicit

SDP PARAMETERS

Content-Type: application/sdp

c= IN IP6 5555::aaa:bbb:ccc:ddd

m= audio 3456 RTP/AVP 97

a= poc-qoe: professional

a= rtpmap:97 AMR

a= rtcp:5560

i= speech
 b= AS:25.4
 a= label:aa
 m= application 2000 udp TBCP
 a= fmtp:TBCP queuing=1; tb_priority=2;
 timestamp=1;multimedia=1;local_grant=1;imp_mb_req=1
 a= floorid:0 mstrm:aa bb
 m= video 5678 RTP/AVP 99
 a= rtpmap:99 MP4V-ES
 b= AS:75
 a= label:bb
 m= message 12345 TCP/MSRP *
 a= accept-types:message/cpim application/vnd.oma.poc.final-report+xml
 application/vnd.oma.poc.detailed-progress-report+xml
 application/vnd.oma.poc.optimized-progress-report+xml
 a= accept-wrapped-types:text/plain
 a= path:msrp://[5555::aaa:bbb:ccc:ddd]:12345/kjhd37s2s20w2a;tcp
 a= max-size:10000

XML MIME BODY

Content-Type: application/resource-lists+xml

Content-Disposition: recipient-list

```
<?xml version="1.0" encoding="UTF-8"?>
```

```

<resource-lists xmlns="urn:ietf:params:xml:ns:resource-lists"
  xmlns:xsi="http://www.w3.org/2001/XMLSchema-instance"
  xmlns:cc="urn:ietf:params:xml:ns:copycontrol"
>

```

```
<list>
```

```

        <entry uri="sip:PoC-UserB@networkB.com" cc:copyControl="to"
cc:anonymize="true"/>

    </list>

</resource-lists>

```

Included Media Content

Content-Type: text/directory;profile="vcard";charset=UTF-8

```

begin:vcard
fn:John P. Smith
n:Smith;John;Peter;Dr.;MBA
EMAIL:TYPE=internet:POC-UserB@networkA.net
version:3.0
end:vcard

```

2. SIP 100 "Trying" response (from SIP/IP Core A to PoC Client A)

The SIP/IP Core A sends a SIP 100 "Trying" response to PoC Client A.

3. SIP INVITE request (from SIP/IP Core A to PoC Server A)

The SIP/IP Core A forwards the SIP INVITE request to the PoC Server A.

Request-URI sip:PoCConferenceFactoryURI.networkA.net

SIP HEADERS

P-Asserted-Identity: "PoC User A" <sip:PoC-UserA@networkA.net>

Accept-Contact: *,+g.poc.talkburst; require;explicit

User-Agent: PoC-client/OMA2.0 Acme-Talk5000/v1.01

Privacy: id

Contact: <sip:PoC-ClientA.networkA.net>;+sip.instance="<urn:uuid:00000000-0000-1000-8000-000A95A0E128>";+g.poc.talkburst;+g.poc.fdcfo;+g.poc.discretedia

Supported: timer

Session-Expires: 1800

Allow: INVITE,ACK,CANCEL,BYE,REFER,OPTIONS,MESSAGE

Require: recipient-list-invite

Content-Type: multipart/mixed
Accept-Language: en
Subject: Let's talk
Alert-Info: <http://publicweb.networkB.net/users/PoC-UserA@networkA.net/myFavouriteRingingTone.wav>
Call-Info: <http://publicweb.networkB.net/users/PoC-UserA@networkA.net/myOwnPicture.jpg>;purpose=icon
Reject-Contact: sip.automata;sip.actor=msg-taker;require;explicit
Reject-Contact: sip.automata;sip.actor=principal;sip.description="poc recording device";require;explicit

SDP PARAMETERS

Content-Type: application/sdp

c= IN IP6 5555::aaa:bbb:ccc:ddd
a= poc-qoe:professional
m= audio 3456 RTP/AVP 97
a= rtpmap:97 AMR
a= rtcp:5560
i= speech
b= AS:25.4
a= label:aa
m= application 2000 udp TBCP
a= fmp:TBCP queuing=1; tb_priority=2; timestamp=1;multimedia=1;local_grant=1;imp_mb_req=1
a= floorid:0 mstrm:aa bb
m= video 5678 RTP/AVP 99
a= rtpmap:99 MP4V-ES
b= AS:75
a= label:bb
m= message 12345 TCP/MSRP *
a= accept-types:message/cpim application/vnd.oma.poc.final-report+xml application/vnd.oma.poc.detailed-progress-report+xml

application/vnd.oma.poc.optimized-progress-report+xml
a= accept-wrapped-types:text/plain
a= path:msrp://[5555::aaa:bbb:ccc:ddd]:12345/kjhd37s2s20w2a;tcp
a= max-size:10000

XML MIME BODY

Content-Type: application/resource-lists+xml

Content-Disposition: recipient-list

```

<?xml version="1.0" encoding="UTF-8"?>

<resource-lists xmlns="urn:ietf:params:xml:ns:resource-lists"
  xmlns:xsi="http://www.w3.org/2001/XMLSchema-instance"
  xmlns:cc="urn:ietf:params:xml:ns:copycontrol"
>
  <list>
    <entry uri="sip:PoC-UserB@networkB.com" cc:copyControl="to"
cc:anonymize="true"/>
  </list>
</resource-lists>

```

Included Media Content

Content-Type: text/directory;profile="vcard";charset=UTF-8

```

begin:vcard
fn:John P. Smith
n:Smith;John;Peter;Dr.;MBA
EMAIL:TYPE=internet:POC-UserB@networkA.net
version:3.0
end:vcard

```

4. SIP 100 "Trying" response (from PoC Server A to SIP/IP Core A)

The PoC Server A sends a SIP 100 "Trying" response to the SIP/IP Core A.

5. PoC Server A sends SIP INVITE requests towards the Invited PoC Clients

The PoC Server A sends SIP INVITE requests to the Invited PoC Client.

Request-URI sip:PoC-UserB@networkB.net

SIP HEADERS

P-Asserted-Identity: "PoC User A" <sip:PoC-UserA@networkA.net>

Accept-Contact: *,+g.poc.talkburst; require;explicit

User-Agent: PoC-serv/OMA2.0

Referred-By: "PoC User A" <sip:PoC-UserA@networkA.net>

Privacy: id

Contact: <sip:PoC-SessionABCDEF@PoC-ServerA.networkA.net;session=1-1>;+g.poc.talkburst;isfocus;+g.poc.discretemedia

Supported: 100rel,timer,norefersub

Session-Expires: 1800

Allow: INVITE,ACK,CANCEL,BYE,PRACK,UPDATE,REFER,MESSAGE,OPTIONS

Subject: Let's talk

Alert-Info: <http://publicweb.networkB.net/users/PoC-UserA@networkA.net/myFavouriteRingingTone.wav>

Call-Info: <http://publicweb.networkB.net/users/PoC-UserA@networkA.net/myOwnPicture.jpg>;purpose=icon

Reject-Contact: sip.automata;sip.actor=msg-taker;require;explicit

Reject-Contact: sip.automata;sip.actor=principal;sip.description="poc recording device";require;explicit

SDP PARAMETERS

Content-Type: application/sdp

c= IN IP6 50555::ccc:ddd:aaa:bbb

a= poc-qoe:professional

m= audio 53456 RTP/AVP 97 98

a= rtpmap:97 AMR

a= rtpmap:98 EVRC/8000
a= rtcp:53080
i= speech
a= label:ll
a= a=upcc:0
m= Application 50000 udp TBCP
a= fmp: TBCP queuing=1; tb_priority=2; timestamp=1;multimedia=1;local_grant=1
a= floorid:0 mstrm:ll kk
m= video 7566 RTP/AVP 99
a= rtpmap:99 MP4V-ES
a= label:kk
a= a=upcc:0
m= message 54321 TCP/MSRP *
a= accept-types:message/cpim application/vnd.oma.poc.final-report+xml
 application/vnd.oma.poc.detailed-progress-report+xml
 application/vnd.oma.poc.optimized-progress-report+xml
a= accept-wrapped-types:text/plain
a= path:msrp://[50555::ccc:ddd:aaa:bbb]:54321/ksdgfjhafdga45sdf2a;tcp
a= max-size:100000000

Included Media Content

Content-Type: text/directory;profile="vcard";charset=UTF-8

begin:vcard
 fn:John P. Smith
 n:Smith;John;Peter;Dr.;MBA
 EMAIL:TYPE=internet:POC-UserB@networkA.net
 version:3.0
 end:vcard

Invited parties identity information

Content-Disposition: recipient-list-history;handling="optional"

Content-Type: application/resource-lists+xml

```
<?xml version="1.0" encoding="UTF-8"?>
<resource-lists
  xmlns="urn:ietf:params:xml:ns:resource-lists"
  xmlns:cc="urn:ietf:params:xml:ns:copycontrol"
>
  <list>
    <entry uri="sip:PoC-UserB@networkB.com" cc:copyControl="to"
cc:anonymize="true"/>
  </list>
</resource-lists>
```

6. PoC Server A receives SIP 180 "Ringling" response

The PoC Server A receives the SIP 180 "Ringling" response.

SIP HEADERS

P-Asserted-Identity: "PoC User B" <sip:PoC-UserB@networkB.net>
Privacy: id
Server: PoC-serv/OMA2.0
Contact: <sip:PoC-SessionABCDEF@PoC-ServerB.networkB.net>;+g.poc.talkburst;+g.poc.fdcfo
Allow: INVITE,ACK,CANCEL,BYE,PRACK,REFER,UPDATE,MESSAGE,OPTIONS

7. SIP 180 "Ringling" response (from PoC Server A to SIP/IP Core A)

The PoC Server A sends the SIP 180 "Ringling" response to the SIP/IP Core A.

SIP HEADERS

P-Asserted-Identity: <sip:PoCConferenceFactoryURI.networkA.net>
Server: PoC-serv/OMA2.0
Contact: <sip:PoC-SessionABCDEF@PoC-ServerA.networkA.net;session=1-1>;+g.poc.talkburst;isfocus
Allow: INVITE,ACK,CANCEL,BYE,PRACK,UPDATE,REFER,MESSAGE,OPTIONS

8. SIP 180 "Ringing" response (from SIP/IP Core A to PoC Client A)

The SIP/IP Core A forwards the SIP 180 "Ringing" response to PoC Client A.

SIP HEADERS

P-Asserted-Identity: <sip:PoCConferenceFactoryURI.networkA.net>
Server: PoC-serv/OMA2.0
Contact: <sip:PoC-SessionABCDEF@PoC-ServerA.networkA.net;session=1-1>;+g.poc.talkburst;isfocus
Allow: INVITE,ACK,CANCEL,BYE,PRACK,UPDATE,REFER,MESSAGE,OPTIONS

9. PoC Server A receives SIP 200 "OK" response

The first SIP 200 "OK" response is received from the terminating PoC Network.

SIP HEADERS

P-Asserted-Identity: "PoC User B" <sip:PoC-UserB@networkB.net>
Privacy: id
Require: timer
Server: PoC-serv/OMA2.0
Session-Expires: 1800;refresher=uas
Contact: <sip:PoC-SessionABCDEF@PoC-ServerB.networkB.net;b2bua>;+g.poc.talkburst;+g.poc.fdcfo
Accept-Language: en
Content-Type: application/sdp

SDP PARAMETERS

c= IN IP6 99055::fff:aaa:eee:bbb
a= poc-qoe:premium
m= audio 59006 RTP/AVP 97
a= rtpmap:97 AMR
a= Rtcp:50000
i= speech
b= AS:25.4
a= label:uu
a= a=upcc:0

```

m=          application 50000 udp TBCP
a=          fmtp:TBCP queuing=1; tb_priority=2;timestamp=1;multimedia=1;local_grant=1
a=          floorid:0 mstrm:uu vv
m=          video 17566 RTP/AVP 99
a=          rtpmap:99 MP4V-ES
b=          AS:75
a=          label:vv
a=          a=upcc:0
m=          message 43821 TCP/MSRP *
a=          accept-types:message/cpim application/vnd.oma.poc.final-report+xml
            application/vnd.oma.poc.detailed-progress-report+xml
            application/vnd.oma.poc.optimized-progress-report+xml
a=          accept-wrapped-types:text/plain
a=          path:msrp://[99055::fff:aaa:eee:bbb]:43821/xk83a45;tcp
a=          max-size:10000

```

10. SIP 200 "OK" response (from PoC Server A to SIP/IP Core A)

The PoC Server A sends a SIP 200 "OK" response to SIP/IP Core A.

SIP HEADERS

```

P-Asserted-Identity: <sip:PoCConferenceFactoryURI.networkA.net>
Require: timer
Server: PoC-serv/OMA2.0
Session-Expires: 1800;refresher=uac
Contact: <sip:PoC-SessionABCDEF@PoC-ServerA.networkA.net;session=1-1>;+g.poc.talkburst;isfocus
Allow: INVITE,ACK,CANCEL,BYE,PRACK,UPDATE,REFER,MESSAGE,OPTIONS
Supported: norefersub

```

SDP PARAMETERS

```

c=          IN IP6 57777::eee:fff:aaa:bbb
a=          poc-qoe:professional
m=          audio 57787 RTP/AVP 97

```

```

i=          speech
a=          label:xxx
a=          rtpmap:97 AMR
a=          Rtcp:57000
m=          application 57790 udp TBCP
a=          fmtp:TBCP queuing=1; tb_priority=2;
           timestamp=1;multimedia=1;local_grant=1;imp_mb_req=1
a=          floorid:0 mstrm:xxx yyy
m=          video 23456 RTP/AVP 99
a=          rtpmap:99 MP4V-ES
a=          label:yyy
m=          message 34567 TCP/MSRP *
a=          accept-types:message/cpim application/vnd.oma.poc.final-report+xml
           application/vnd.oma.poc.detailed-progress-report+xml
           application/vnd.oma.poc.optimized-progress-report+xml
a=          accept-wrapped-types:text/plain
a=          path:msrp://[57777::eee:fff:aaa:bbb]:12345/jshA7weztas;tcp

```

A. MBCP Media Burst Granted (PoC Server A to PoC Client A)

The PoC Server A sends MBCP Media Burst Granted message to PoC Client A.

11. SIP 200 "OK" response (from SIP/IP Core A to PoC Client A)

The SIP/IP Core A forwards the SIP 200 "OK" response to PoC Client A.

SIP HEADERS

```

P-Asserted-Identity:    <sip:PoCConferenceFactoryURI.networkA.net>
Require:                timer
Server:                 PoC-serv/OMA2.0
Session-Expires:       1800;refresher=uac
Contact:               <sip:PoC-SessionABCDEF@PoC-ServerA.networkA.net;session=1-
                           1>;+g.poc.talkburst;isfocus
Allow:                  INVITE,ACK,CANCEL,BYE,PRACK,UPDATE,
                           REFER,MESSAGE,OPTIONS
Supported:             norefersub

```

SDP PARAMETERS

```

c=                IN IP6 57777::eee:fff:aaa:bbb
a=                poc-qoe:professional
m=                audio 57787 RTP/AVP 97
i=                speech
a=                label:xxx
a=                rtpmap:97 AMR
a=                Rtcp:57000
m=                application 57790 udp TBCP
a=                fmp: TBCP queuing=1; tb_priority=2;
                  timestamp=1;multimedia=1;local_grant=1;imp_mb_req=1
a=                floorid:0 mstrm:xxx yyy
m=                video 23456 RTP/AVP 99
a=                rtpmap:99 MP4V-ES
a=                label:yyy
m=                message 34567 TCP/MSRP *
a=                accept-types:message/cpim application/vnd.oma.poc.final-report+xml
                  application/vnd.oma.poc.detailed-progress-report+xml
                  application/vnd.oma.poc.optimized-progress-report+xml
a=                accept-wrapped-types:text/plain
a=                path:msrp://[57777::eee:fff:aaa:bbb]:12345/jshA7weztas;tcp

```

12. SIP ACK request (from PoC Client A to SIP/IP Core A)

The PoC Client A sends a SIP ACK request to SIP/IP Core A.

B. PoC Client sends RTP Media to PoC Server A

The PoC Client A sends RTP Media packets to PoC Server A.

13. SIP ACK request (from SIP/IP Core A to PoC Server A)

The SIP/IP Core A forwards the SIP ACK request to PoC Server A.

F.5 Ad-hoc and 1-1 PoC Session establishment On-demand Session

F.5.1 Terminating flow – Manual Answer

PoC Server X invites the PoC Client B to a PoC Session by sending a SIP INVITE request to the terminating SIP/IP Core.

The signaling sequences in this subclause show the establishment of the Ad-hoc or 1-1 PoC Session using on-demand signaling in the terminating side. As a prerequisite for the on-demand signaling, the PoC Client needs to be registered.

This scenario applies for the On-demand Session case.

QoE Profiles feature is used in this flow, QoE Profile assigned to the PoC Session is Professional QoE Profile and PoC Client B is subscribed and selects Premium as Local QoE Profile.

This flow shows the signaling sequence for the manual answer case. The flow is as shown in Figure 10 "*PoC Session invitation with manual answer*".

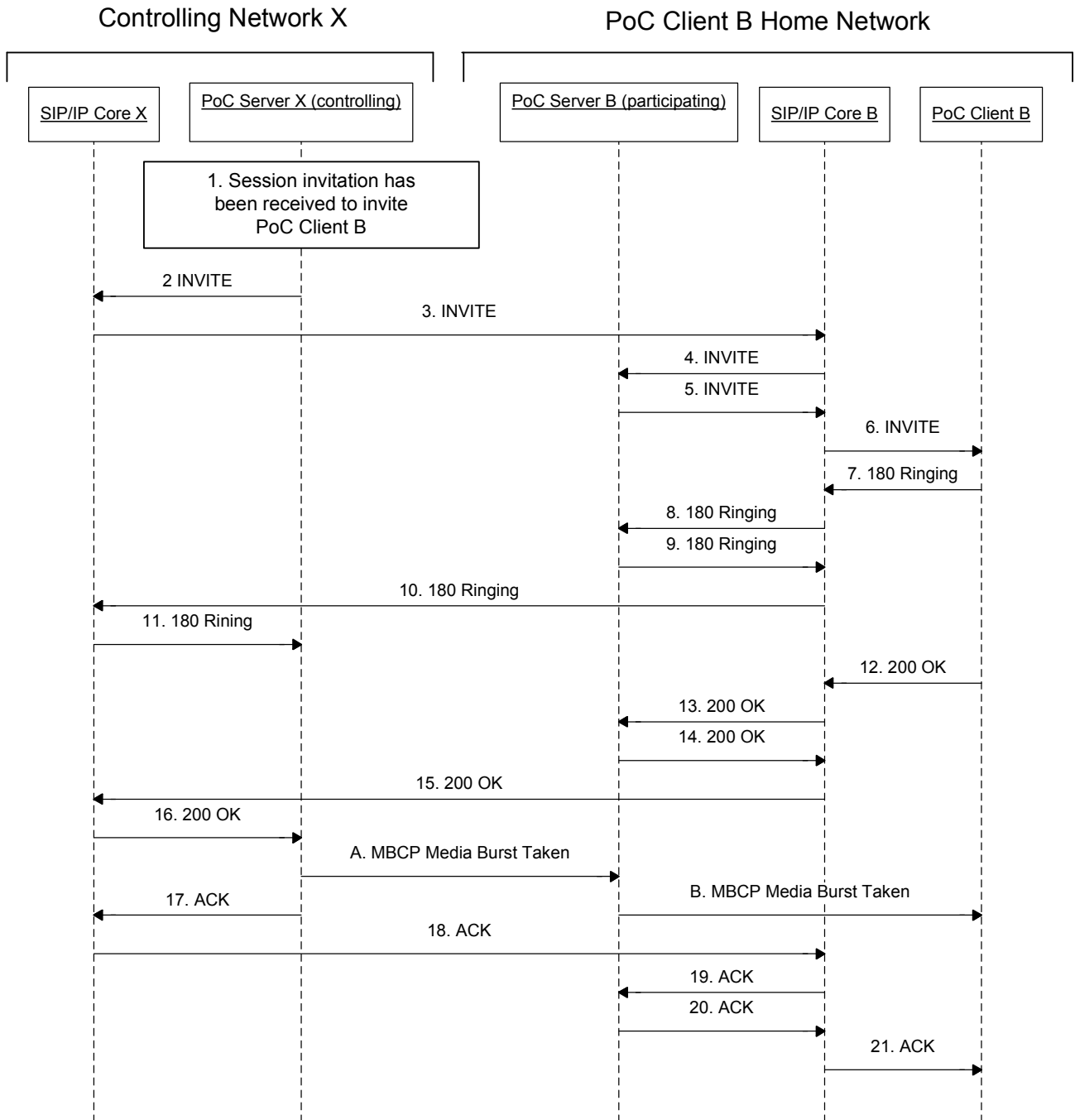

Figure 10: PoC Session invitation with manual answer

The steps of the flow are as follows:

1. Session invitation has been received to invite PoC Client
2. SIP INVITE request (from the PoC Server X to SIP/IP Core X)

PoC Server X sends the SIP INVITE request to SIP/IP Core X.

Request-URI sip:PoC-UserB@networkB.net

SIP HEADERS

P-Asserted-Identity: "PoC User A" <sip:PoC-UserA@networkA.net>

Accept-Contact: *,+g.poc.talkburst; require;explicit

User-Agent: PoC-serv/OMA2.0

Referred-By: "PoC User A" <sip:PoC-UserA@networkA.net>

Privacy: id

Contact: <sip:PoC-SessionABCDEF@PoC-ServerX.networkX.net;session=1-1>;+g.poc.talkburst; isfocus;+g.poc.discretemedia

Supported: 100rel,norefersub,timer

Session-Expires: 1800

Allow: INVITE,ACK,CANCEL,BYE,PRACK,UPDATE,REFER,MESSAGE,OPTIONS

Subject: Let's talk

Alert-Info: <http://publicweb.networkB.net/users/PoC-UserA@networkA.net/myFavouriteRingtone.wav>

Call-Info: <http://publicweb.networkB.net/users/PoC-UserA@networkA.net/myOwnPicture.jpg>;purpose=icon

Reject-Contact: sip.automata;sip.actor=msg-taker;require;explicit

Reject-Contact: sip.automata;sip.actor=principal;sip.description="poc recording device";require;explicit

SDP PARAMETERS

Content-Type: application/sdp

c= IN IP6 50555::ccc:ddd:aaa:bbb

a= poc-qoe:professional

m= audio 53456 RTP/AVP 97 98

a= rtpmap:97 AMR

a= rtpmap:98 EVRC/8000

a= rtcp:53080

i= speech

a= label:ll
a= a=upcc:0
m= Application 50000 udp TBCP
a= fmp: TBCP queuing=1; tb_priority=2; timestamp=1;multimedia=1;local_grant=1
a= floorid:0 mstrm:ll kk
m= video 7566 RTP/AVP 99
a= rtpmap:99 MP4V-ES
a= label:kk
a= a=upcc:0
m= message 54321 TCP/MSRP *
a= accept-types:message/cpim application/vnd.oma.poc.final-report+xml
application/vnd.oma.poc.detailed-progress-report+xml
application/vnd.oma.poc.optimized-progress-report+xml
a= accept-wrapped-types:text/plain
a= path:msrp://[50555::ccc:ddd:aaa:bbb]:54321/ksdghafhdga45sdf2a;tcp
a= max-size:100000000

Included Media Content

Content-Type: text/directory;profile="vcard";charset=UTF-8

begin:vcard
fn:John P. Smith
n:Smith;John;Peter;Dr.;MBA
EMAIL:TYPE=internet:POC-UserB@networkA.net
version:3.0
end:vcard

Invited parties identity information

Content-Disposition: recipient-list-history;handling="optional"
Content-Type: application/resource-lists+xml

<?xml version="1.0" encoding="UTF-8"?>

```

<resource-lists
  xmlns="urn:ietf:params:xml:ns:resource-lists"
  xmlns:cc="urn:ietf:params:xml:ns:copycontrol"
>
  <list>
    <entry uri="sip:PoC-UserB@networkB.com" cc:copyControl="to"
cc:anonymize="true"/>
  </list>
</resource-lists>

```

3. SIP INVITE request (from SIP/IP Core X to SIP/IP Core B)

SIP/IP Core X forwards the SIP INVITE request to SIP/IP Core B.

Request-URI sip:PoC-UserB@networkB.net

SIP HEADERS

P-Asserted-Identity: "PoC User A" <sip:PoC-UserA@networkA.net>

Accept-Contact: *,+g.poc.talkburst; require;explicit

User-Agent: PoC-serv/OMA2.0

Referred-By: "PoC User A" <sip:PoC-UserA@networkA.net>

Privacy: id

Contact: <sip:PoC-SessionABCDEF@PoC-ServerX.networkX.net;session=1-1>;+g.poc.talkburst;isfocus;+g.poc.discretemedia

Supported: 100rel,norefersub,timer

Session-Expires: 1800

Allow: INVITE,ACK,CANCEL,BYE,PRACK,UPDATE,REFER,MESSAGE,OPTIONS

Subject: Let's talk

Alert-Info: <http://publicweb.networkB.net/users/PoC-UserA@networkA.net/myFavouriteRingingTone.wav>

Call-Info: <http://publicweb.networkB.net/users/PoC-UserA@networkA.net/myOwnPicture.jpg>;purpose=icon

Reject-Contact: sip.automata;sip.actor=msg-taker;require;explicit

Reject-Contact: sip.automata;sip.actor=principal;sip.description="poc recording device";require;explicit

SDP PARAMETERS

Content-Type: application/sdp

c= IN IP6 50555::ccc:ddd:aaa:bbb
a= poc-qoe:professional
m= audio 53456 RTP/AVP 97 98
a= rtpmap:97 AMR
a= rtpmap:98 EVRC/8000
a= rtcp:53080
i= speech
a= label:ll
a= a=upcc:0
m= Application 50000 udp TBCP
a= fmp: TBCP queuing=1; tb_priority=2; timestamp=1;multimedia=1;local_grant=1
a= floorid:0 mstrm:ll kk
m= video 7566 RTP/AVP 99
a= rtpmap:99 MP4V-ES
a= label:kk
a= a=upcc:0
m= message 54321 TCP/MSRP *
a= accept-types:message/cpim application/vnd.oma.poc.final-report+xml
application/vnd.oma.poc.detailed-progress-report+xml
application/vnd.oma.poc.optimized-progress-report+xml
a= accept-wrapped-types:text/plain
a= path:msrp://[50555::ccc:ddd:aaa:bbb]:54321/ksdghafhdga45sdf2a;tcp
a= max-size:100000000

Included Media Content

Content-Type: text/directory;profile="vcard";charset=UTF-8

begin:vcard

fn:John P. Smith

n:Smith;John;Peter;Dr.;MBA
 EMAIL:TYPE=internet:POC-UserB@networkA.net
 version:3.0
 end:vcard

Invited parties identity information

Content-Disposition: recipient-list-history;handling="optional"
Content-Type: application/resource-lists+xml

```
<?xml version="1.0" encoding="UTF-8"?>
<resource-lists
  xmlns="urn:ietf:params:xml:ns:resource-lists"
  xmlns:cc="urn:ietf:params:xml:ns:copycontrol"
>
  <list>
    <entry uri="sip:PoC-UserB@networkB.com" cc:copyControl="to"
cc:anonymize="true"/>
  </list>
</resource-lists>
```

4. SIP INVITE request (from SIP/IP Core B to PoC Server B)

SIP/IP Core B forwards the SIP INVITE request to PoC Server B.

Request-URI sip:PoC-UserB@networkB.net

SIP HEADERS

P-Asserted-Identity: "PoC User A" <sip:PoC-UserA@networkA.net>
Accept-Contact: *,+g.poc.talkburst; require;explicit
User-Agent: PoC-serv/OMA2.0
Referred-By: "PoC User A" <sip:PoC-UserA@networkA.net>
Privacy: id
Contact: <sip:PoC-SessionABCDEF@PoC-ServerX.networkX.net;session=1-1>;+g.poc.talkburst;isfocus;+g.poc.discretemedia

Supported: 100rel,norefersub,timer
Session-Expires: 1800
Allow: INVITE,ACK,CANCEL,BYE,PRACK,UPDATE,REFER,MESSAGE,OPTIONS
Subject: Let's talk
Alert-Info: <http://publicweb.networkB.net/users/PoC-UserA@networkA.net/myFavouriteRingingTone.wav>
Call-Info: <http://publicweb.networkB.net/users/PoC-UserA@networkA.net/myOwnPicture.jpg>;purpose=icon
Reject-Contact: sip.automata;sip.actor=msg-taker;require;explicit
Reject-Contact: sip.automata;sip.actor=principal;sip.description="poc recording device";require;explicit

SDP PARAMETERS

Content-Type: application/sdp

c= IN IP6 50555::ccc:ddd:aaa:bbb
m= audio 53456 RTP/AVP 97 98
a= poc-qoe:professional
a= rtpmap:97 AMR
a= rtpmap:98 EVRC/8000
a= rtcp:53080
i= speech
a= label:ll
a= a=upcc:0
m= Application 50000 udp TBCP
a= fmp: TBCP queuing=1; tb_priority=2; timestamp=1;multimedia=1;local_grant=1
a= floorid:0 mstrm:ll kk
m= video 7566 RTP/AVP 99
a= rtpmap:99 MP4V-ES
a= label:kk
a= a=upcc:0
m= message 54321 TCP/MSRP *
a= accept-types:message/cpim application/vnd.oma.poc.final-report+xml
 application/vnd.oma.poc.detailed-progress-report+xml

application/vnd.oma.poc.optimized-progress-report+xml
 a= accept-wrapped-types:text/plain
 a= path:msrp://[50555::ccc:ddd:aaa:bbb]:54321/ksdgfjhafdga45sdf2a;tcp
 a= max-size:100000000

Included Media Content

Content-Type: text/directory;profile="vcard";charset=UTF-8

```

begin:vcard
fn:John P. Smith
n:Smith;John;Peter;Dr.;MBA
EMAIL:TYPE=internet:POC-UserB@networkA.net
version:3.0
end:vcard

```

Invited parties identity information

Content-Disposition: recipient-list-history;handling="optional"

Content-Type: application/resource-lists+xml

```

<?xml version="1.0" encoding="UTF-8"?>
<resource-lists
  xmlns="urn:ietf:params:xml:ns:resource-lists"
  xmlns:cc="urn:ietf:params:xml:ns:copycontrol"
>
  <list>
    <entry uri="sip:PoC-UserB@networkB.com" cc:copyControl="to"
cc:anonymize="true"/>
  </list>
</resource-lists>

```

5. SIP INVITE request (from PoC Server B to SIP/IP Core B)

PoC Server B sends a SIP INVITE request to SIP/IP Core B.

Request-URI sip:PoC-UserB@networkB.net

SIP HEADERS

P-Asserted-Identity: "PoC User A" <sip:PoC-UserA@networkA.net>
Accept-Contact: *;+g.poc.talkburst; require;explicit
User-Agent: PoC-serv/OMA2.0
Privacy: id
Contact: <sip:PoC-SessionABCDEF@PoC_ServerB.networkB.net;session=1-1>;+g.poc.talkburst;isfocus;+g.poc.discretemedia
Supported: norefersub,timer
Session-Expires: 1800
Answer-Mode: Manual;Require
Allow: INVITE,ACK,CANCEL,BYE,PRACK,UPDATE,REFER,MESSAGE,OPTIONS
Subject: Let's talk
Alert-Info: <http://publicweb.networkB.net/users/PoC-UserA@networkA.net/myFavouriteRingtone.wav>
Call-Info: <http://publicweb.networkB.net/users/PoC-UserA@networkA.net/myOwnPicture.jpg>;purpose=icon
Reject-Contact: sip.automata;sip.actor=msg-taker;require;explicit
Reject-Contact: sip.automata;sip.actor=principal;sip.description="poc recording device";require;explicit

SDP PARAMETERS

c= IN IP6 60333::ddd:ccc:aaa:bbb
a= poc-qoe:professional
m= audio 63776 RTP/AVP 98
a= rtpmap:98 EVRC/8000
a= rtcp:63090
i= speech
a= label:al
m= Application 60000 udp TBCP
a= fmp: TBCP queuing=1; tb_priority=2; timestamp=1;multimedia=1;local_grant=1
a= floorid:0 mstrm:al ak
m= video 47566 RTP/AVP 99

a= rtpmap:99 MP4V-ES
a= label:ak
a= a=upcc:0
m= message 44321 TCP/MSRP *
a= accept-types:message/cpim application/vnd.oma.poc.final-report+xml
 application/vnd.oma.poc.detailed-progress-report+xml
 application/vnd.oma.poc.optimized-progress-report+xml
a= accept-wrapped-types:text/plain
a= path:msrp://[60333::ddd:ccc:aaa:bbb]:44321/gsgsdfg4;tcp
a= max-size:100000000

Included Media Content

Content-Type: text/directory;profile="vcard";charset=UTF-8

 begin:vcard
 fn:John P. Smith
 n:Smith;John;Peter;Dr.;MBA
 EMAIL:TYPE=internet:POC-UserB@networkA.net
 version:3.0
 end:vcard

Invited parties identity information

Content-Disposition: recipient-list-history;handling="optional"
Content-Type: application/resource-lists+xml

```

<?xml version="1.0" encoding="UTF-8"?>
<resource-lists
  xmlns="urn:ietf:params:xml:ns:resource-lists"
  xmlns:cc="urn:ietf:params:xml:ns:copycontrol"
>
  <list>
    <entry uri="sip:anonymous@anonymous.invalid" cc:copyControl="to"
    cc:count="2"/>
  
```

```

</list>

</resource-lists>

```

6. SIP INVITE request (from SIP/IP Core B to PoC Client B)

SIP/IP Core B forwards the SIP INVITE request to PoC Client B.

Request-URI sip:PoC-UserB@networkB.net

SIP HEADERS

Accept-Contact: *,+g.poc.talkburst; require;explicit

User-Agent: PoC-serv/OMA2.0

Contact: <sip:PoC-SessionABCDEF@PoC_ServerB.networkB.net;session=1-1>;
+g.poc.talkburst;isfocus;+g.poc.discretemedia

Supported: norefersub,timer

Session-Expires: 1800

Answer-Mode: Manual;Require

Allow: INVITE,ACK,CANCEL,BYE,PRACK,UPDATE,REFER,MESSAGE,OPTIONS

Subject: Let's talk

Alert-Info: <http://publicweb.networkB.net/users/PoC-
UserA@networkA.net/myFavouriteRingtone.wav>

Call-Info: <http://publicweb.networkB.net/users/PoC-
UserA@networkA.net/myOwnPicture.jpg>;purpose=icon

Reject-Contact: sip.automata;sip.actor=msg-taker;require;explicit

Reject-Contact: sip.automata;sip.actor=principal;sip.description="poc recording
device";require;explicit

SDP PARAMETERS

c= IN IP6 60333::ddd:ccc:aaa:bbb

a= poc-qoe:professional

m= audio 63776 RTP/AVP 98

a= rtpmap:98 EVRC/8000

a= rtcp:63090

i= speech

a= label:al

m= Application 60000 udp TBCP
a= ftmp:TBCP queuing=1; tb_priority=2; timestamp=1;multimedia=1;local_grant=1
a= floorid:0 mstrm:al ak
m= video 47566 RTP/AVP 99
a= rtpmap:99 MP4V-ES
a= label:ak
a= a=upcc:0
m= message 44321 TCP/MSRP *
a= accept-types:message/cpim application/vnd.oma.poc.final-report+xml
application/vnd.oma.poc.detailed-progress-report+xml
application/vnd.oma.poc.optimized-progress-report+xml
a= accept-wrapped-types:text/plain
a= path:msrp://[60333::ddd:ccc:aaa:bbb]:44321/gsgsdfg4;tcp
a= max-size:100000000

Included Media Content

Content-Type: text/directory;profile="vcard";charset=UTF-8

begin:vcard
fn:John P. Smith
n:Smith;John;Peter;Dr.;MBA
EMAIL:TYPE=internet:POC-UserB@networkA.net
version:3.0
end:vcard

Invited parties identity information

Content-Disposition: recipient-list-history;handling="optional"

Content-Type: application/resource-lists+xml

```

<?xml version="1.0" encoding="UTF-8"?>
<resource-lists
  xmlns="urn:ietf:params:xml:ns:resource-lists"

```

```

xmlns:cc="urn:ietf:params:xml:ns:copycontrol"
>
<list>
  <entry uri="sip:anonymous@anonymous.invalid" cc:copyControl="to"
cc:count="2"/>
</list>
</resource-lists>

```

7. SIP 180 "Ringing" response (from PoC Client B to SIP/IP Core B)

PoC Client B sends a SIP 180 "Ringing" response to SIP/IP Core B.

SIP HEADERS

P-Preferred-Identity: "PoC User B" <sip:PoC-UserB@networkB.net>
Privacy: id
Require: timer
Server: PoC-client/OMA2.0 Acme-Talk5000/v1.01
Contact: <sip:PoC-ClientB.networkB.net>;+sip.instance="<urn:uuid:00000000-0000-1000-8000-000A95A0E128>";+g.poc.talkburst;+g.poc.fdcfo
Allow: INVITE,ACK,CANCEL,BYE,REFER,MESSAGE,OPTIONS
Accept-Language: en

8. SIP 180 "Ringing" response (from SIP/IP Core B to PoC Server B)

SIP/IP Core B forwards the SIP 180 "Ringing" response to PoC Server B.

SIP HEADERS

P-Asserted-Identity: "PoC User B" <sip:PoC-UserB@networkB.net>
Privacy: id
Require: timer
Server: PoC-client/OMA2.0 Acme-Talk5000/v1.01
Contact: <sip:PoC-ClientB.@networkB.net>; +sip.instance="<urn:uuid:00000000-0000-1000-8000-000A95A0E128>";+g.poc.talkburst;+g.poc.fdcfo
Allow: INVITE,ACK,CANCEL,BYE,REFER,MESSAGE,OPTIONS
Accept-Language: en

9. SIP 180 "Ringing" response (from PoC Server B to SIP/IP Core B)

PoC Server B sends a SIP 180 "Ringing" response to SIP/IP Core B.

SIP HEADERS

P-Asserted-Identity: "PoC User B" <sip:PoC-UserB@networkB.net>
Privacy: id
Server: PoC-serv/OMA2.0
Contact: <sip:PoC-SessionABCDEF@PoC-ServerB.networkB.net;b2bua>;+g.poc.talkburst;+g.poc.fdcfo
Allow: INVITE,ACK,CANCEL,BYE,REFER,PRACK,UPDATE,MESSAGE,OPTIONS

10. SIP 180 "Ringing" response (from SIP/IP Core B to SIP/IP Core X)

SIP/IP Core B forwards the SIP 180 "Ringing" response to SIP/IP Core X.

SIP HEADERS

P-Asserted-Identity: "PoC User B" <sip:PoC-UserB@networkB.net>
Privacy: id
Server: PoC-serv/OMA2.0
Contact: <sip:PoC-SessionABCDEF@PoC-ServerB.networkB.net>;+g.poc.talkburst;+g.poc.fdcfo
Allow: INVITE,ACK,CANCEL,BYE,REFER,PRACK,UPDATE,MESSAGE,OPTIONS

11. SIP 180 "Ringing" response (from SIP/IP Core X to PoC Server X)

SIP/IP Core X forwards the SIP 180 "Ringing" response to PoC Server X.

SIP HEADERS

P-Asserted-Identity: "PoC User B" <sip:PoC-UserB@networkB.net>
Privacy: id
Server: PoC-serv/OMA2.0
Contact: <sip:PoC-SessionABCDEF@PoC-ServerB.networkB.net>;+g.poc.talkburst;+g.poc.fdcfo
Allow: INVITE,ACK,CANCEL,BYE,REFER,PRACK,UPDATE,MESSAGE,OPTIONS

12. SIP 200 "OK" response (from PoC Client B to SIP/IP Core B)

PoC Client B sends a SIP 200 "OK" response to SIP/IP Core B. PoC User B is not allowed to use Professional QoE Profile because he is subscribed to Premium QoE Profile.

SIP HEADERS

P-Preferred-Identity: "PoC User B" <sip:PoC-UserB@networkB.net>
Privacy: id
Require: timer
Server: PoC-client/OMA2.0 Acme-Talk5000/v1.01
Session-Expires: 1800;refresher=uas
Contact: <sip:PoC-ClientB.networkB.net>;+sip.instance="<urn:uuid:00000000-0000-1000-8000-000A95A0E128>";+g.poc.talkburst;+g.poc.fdcfo;+g.poc.discretemedia
Allow: INVITE,ACK,CANCEL,BYE,REFER,MESSAGE,OPTIONS
Accept-Language: en

SDP PARAMETERS

c= IN IP6 75555::eee:aaa:fff:bbb
a= poc-qoe:premium
m= audio 75575 RTP/AVP 98
a= rtpmap:98 EVRC/8000
a= rtcp:75000
i= speech
a= label:bl
b= AS:25.4
m= application 75590 udp TBCP
a= fmp: TBCP queuing=1; tb_priority=2;timestamp=1;multimedia=1;local_grant=1
a= floorid:0 mstrm:bl bk
m= video 47888 RTP/AVP 99
a= rtpmap:99 MP4V-ES
a= label:bk
a= a=upcc:0
m= message 22335 TCP/MSRP *
a= accept-types:message/cpim application/vnd.oma.poc.final-report+xml
application/vnd.oma.poc.detailed-progress-report+xml
application/vnd.oma.poc.optimized-progress-report+xml

a= accept-wrapped-types:text/plain
a= path:msrp://[75555::eee:aaa:fff:bbb]:22335/45yzxcasd;tcp
a= max-size:20000

13. SIP 200 "OK" response (from SIP/IP Core B to PoC Server B)

SIP/IP Core B forwards the SIP 200 "OK" response to PoC Server B.

SIP HEADERS

P-Asserted-Identity: "PoC User B" <sip:PoC-UserB@networkB.net>
Privacy: id
Require: timer
Server: PoC-client/OMA2.0 Acme-Talk5000/v1.01
Session-Expires: 1800;refresher=uas
Contact: <sip:PoC-ClientB.networkB.net>;+sip.instance="<urn:uuid:00000000-0000-1000-8000-000A95A0E128>";+g.poc.talkburst;+g.poc.fdcfo;+g.poc.discretedia
Allow: INVITE,ACK,CANCEL,BYE,REFER,MESSAGE,OPTIONS
Accept-Language: en

SDP PARAMETERS

c= IN IP6 75555::eee:aaa:fff:bbb
a= poc-qoe:premium
m= audio 75575 RTP/AVP 98
a= rtpmap:98 EVRC/8000
a= rtcp:75000
i= speech
a= label:bl
b= AS:25.4
m= application 75590 udp TBCP
a= fmp: TBCP queuing=1; tb_priority=2;timestamp=1;multimedia=1;local_grant=1
a= floorid:0 mstrm:bl bk
m= video 47888 RTP/AVP 99
a= rtpmap:99 MP4V-ES

a= label:bk
 a= a=upcc:0
 m= message 22335 TCP/MSRP *
 a= accept-types:message/cpim application/vnd.oma.poc.final-report+xml
 application/vnd.oma.poc.detailed-progress-report+xml
 application/vnd.oma.poc.optimized-progress-report+xml
 a= accept-wrapped-types:text/plain
 a= path:msrp://[75555::eee:aaa:fff:bbb]:22335/45yzxcasd;tcp
 a= max-size:20000

14. SIP 200 "OK" response (from PoC Server B to SIP/IP Core B)

PoC Server B sends a SIP 200 "OK" response to SIP/IP Core B.

SIP HEADERS

P-Asserted-Identity: "PoC User B" <sip:PoC-UserB@networkB.net>
Privacy: id
Require: timer
Server: PoC-serv/OMA2.0
Session-Expires: 1800;refresher=uas
Contact: <sip:PoC-SessionABCDEF@PoC-
 ServerB.networkB.net;b2bua>;+g.poc.talkburst;+g.poc.fdcfo;+g.poc.discretedia
Accept-Language: en

SDP PARAMETERS

c= IN IP6 99055::fff:aaa:eee:bbb
 a= poc-qoe:premium
 m= audio 59006 RTP/AVP 98
 a= rtpmap:98 EVRC/8000
 a= rtcp:50000
 i= speech
 b= AS:25.4
 a= label:uu
 a= a=upcc:0
 m= application 50000 udp TBCP

```

a=          fmtp:TBCP queuing=1; tb_priority=2;timestamp=1;multimedia=1;local_grant=1
a=          floorid:0 mstrm:uu vv
m=          video 17566 RTP/AVP 99
a=          rtpmap:99 MP4V-ES
b=          AS:75
a=          label:vv
a=          a=upcc:0
m=          message 43821 TCP/MSRP *
a=          accept-types:message/cpim application/vnd.oma.poc.final-report+xml
            application/vnd.oma.poc.detailed-progress-report+xml
            application/vnd.oma.poc.optimized-progress-report+xml
a=          accept-wrapped-types:text/plain
a=          path:msrp://[99055::fff:aaa:eee:bbb]:43821/xk83a45;tcp
a=          max-size:10000

```

15. SIP 200 "OK" response (from SIP/IP Core B to SIP/IP Core X)

SIP/IP Core B forwards the SIP 200 "OK" response to SIP/IP Core X.

SIP HEADERS

```

P-Asserted-Identity:    "PoC User B" <sip:PoC-UserB@networkB.net>
Privacy:                id
Require:                timer
Server:                PoC-serv/OMA2.0
Session-Expires:      1800;refresher=uas
Contact:               <sip:PoC-SessionABCDEF@PoC-
                        ServerB.networkB.net;b2bua>;+g.poc.talkburst;+g.poc.fdcfo;+g.poc.discretemedia
Accept-Language:      en

```

SDP PARAMETERS

```

c=          IN IP6 99055::fff:aaa:eee:bbb
a=          poc-qoe:premium
m=          audio 59006 RTP/AVP 98
a=          rtpmap:98 EVRC/8000
a=          rtcp:50000

```

i= speech
 b= AS:25.4
 a= label:uu
 a= a=upcc:0
 m= application 50000 udp TBCP
 a= fmtp:TBCP queuing=1; tb_priority=2;timestamp=1;multimedia=1;local_grant=1
 a= floorid:0 mstrm:uu vv
 m= video 17566 RTP/AVP 99
 a= rtpmap:99 MP4V-ES
 b= AS:75
 a= label:vv
 a= a=upcc:0
 m= message 43821 TCP/MSRP *
 a= accept-types:message/cpim application/vnd.oma.poc.final-report+xml
 application/vnd.oma.poc.detailed-progress-report+xml
 application/vnd.oma.poc.optimized-progress-report+xml
 a= accept-wrapped-types:text/plain
 a= path:msrp://[99055::fff:aaa:eee:bbb]:43821/xk83a45;tcp
 a= max-size:10000

16. SIP 200 "OK" response (from SIP/IP Core X to PoC Server X)

SIP/IP Core X forwards the SIP 200 "OK" response to PoC Server X.

SIP HEADERS

P-Asserted-Identity: "PoC User B" <sip:PoC-UserB@networkB.net>
Privacy: id
Require: timer
Server: PoC-serv/OMA2.0
Session-Expires: 1800;refresher=uas
Contact: <sip:PoC-SessionABCDEF@PoC-ServerB.networkB.net;b2bua>;+g.poc.talkburst;+g.poc.fdcfo;+g.poc.discretemedia
Accept-Language: en

SDP PARAMETERS

```

c=          IN IP6 99055::fff:aaa:eee:bbb
a=          poc-qoe:premium
m=          audio 59006 RTP/AVP 98
a=          rtpmap:98 EVRC/8000
a=          rtcp:50000
i=          speech
b=          AS:25.4
a=          label:uu
a=          a=upcc:0
m=          application 50000 udp TBCP
a=          fmtp:TBCP queuing=1;tb_priority=2;timestamp=1;multimedia=1;local_grant=1
a=          floorid:0 mstrm:uu vv
m=          video 17566 RTP/AVP 99
a=          rtpmap:99 MP4V-ES
b=          AS:75
a=          label:vv
a=          a=upcc:0
m=          message 43821 TCP/MSRP *
a=          accept-types:message/cpim application/vnd.oma.poc.final-report+xml
            application/vnd.oma.poc.detailed-progress-report+xml
            application/vnd.oma.poc.optimized-progress-report+xml
a=          accept-wrapped-types:text/plain
a=          path:msrp://[99055::fff:aaa:eee:bbb]:43821/xk83a45;tcp
a=          max-size:10000

```

A. MBCP Media Burst Taken message (from PoC Server X to PoC Server B).

The MBCP Media Burst Taken message is sent to inform the PoC Client B that another PoC Client has been granted to send a Media Burst. The message contains the identity of the PoC User that has been granted to send a Media Burst.

B. MBCP Media Burst Taken message (from PoC Server B to PoC Client B).

The MBCP Media Burst Taken message is sent to inform the PoC Client B that another PoC Client has been granted to send a Media Burst. The message contains the identity of the PoC User that has been granted to send a Media Burst.

17. SIP ACK request (from PoC Server X to SIP/IP Core X)

PoC Server X sends a SIP ACK request to SIP/IP Core X.

18. SIP ACK request (from SIP/IP Core X to SIP/IP Core B)

SIP/IP Core X forwards the SIP ACK request to SIP/IP Core B.

19. SIP ACK request (from SIP/IP Core B to PoC Server B)

SIP/IP Core B forwards the SIP ACK request to PoC Server B.

20. SIP ACK request (from PoC Server B to SIP/IP Core B)

PoC Server B sends a SIP ACK request to SIP/IP Core B.

21. SIP ACK request (from SIP/IP Core B to PoC Client B)

SIP/IP Core B forwards the SIP ACK request to PoC Client B.

F.5.2 Terminating flow – Automatic Answer

This flow shows the automatic answer case for the On-demand Session case.

QoE Profiles feature is used in this flow, QoE Profile assigned to the PoC Session is Professional QoE Profile and PoC Client B is subscribed and selects Premium as Local QoE Profile.

The flows in Figure 11 "*PoC Session invitation with automatic answer*" shows the message flow for the scenario.

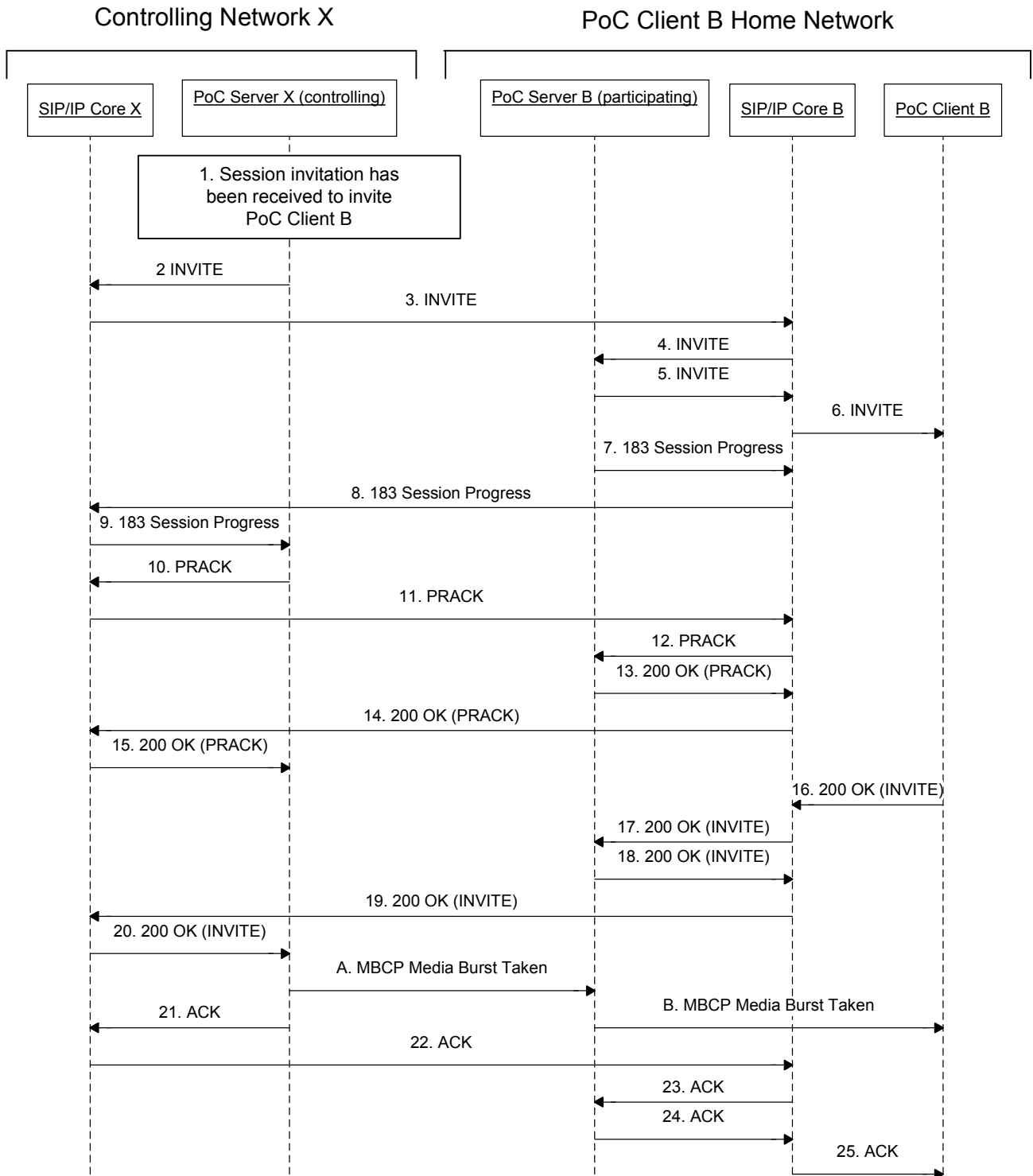

Figure 11: PoC Session invitation with automatic answer

The steps of the flow are as follows:

1. Session invitation has been received to invite PoC Client

2. SIP INVITE request (from PoC Server X to SIP/IP Core X)

PoC Server X sends the SIP INVITE request to SIP/IP Core X.

Request-URI sip:PoC-UserB@networkB.net

SIP HEADERS

P-Asserted-Identity: "PoC User A" <sip:PoC-UserA@networkA.net>

Accept-Contact: *,+g.poc.talkburst; require;explicit

User-Agent: PoC-serv/OMA2.0

Referred-By: "PoC User A" <sip:PoC-UserA@networkA.net>

Privacy: id

Contact: <sip:PoC-SessionABCDEF@PoC-ServerX.networkX.net;session=adhoc>;+g.poc.talkburst;isfocus;+g.poc.discretemedia

Supported: 100rel,norefersub,timer

Session-Expires: 1800

Allow: INVITE,ACK,CANCEL,BYE,PRACK,UPDATE,REFER,MESSAGE,OPTIONS

Subject: Let's talk

Alert-Info: <http://publicweb.networkB.net/users/PoC-UserA@networkA.net/myFavouriteRingtone.wav>

Call-Info: <http://publicweb.networkB.net/users/PoC-UserA@networkA.net/myOwnPicture.jpg>;purpose=icon

Reject-Contact: sip.automata;sip.actor=msg-taker;require:explicit

Reject-Contact: sip.automata;sip.actor=principal;sip.description="poc recording device";require:explicit

SDP PARAMETERS

Content-Type: application/sdp

c= IN IP6 50555::ccc:ddd:aaa:bbb

a= poc-qoe:professional

m= audio 53456 RTP/AVP 97 98

a= rtpmap:97 AMR

a= rtpmap:98 EVRC/8000

a= rtcp:53080

i= speech
a= label:ll
a= a=upcc:0
m= Application 50000 udp TBCP
a= fmp: TBCP queuing=1; tb_priority=2; timestamp=1;multimedia=1;local_grant=1
a= floorid:0 mstrm:ll kk
m= video 7566 RTP/AVP 99
a= rtpmap:99 MP4V-ES
a= label:kk
a= a=upcc:0
m= message 54321 TCP/MSRP *
a= accept-types:message/cpim application/vnd.oma.poc.final-report+xml
application/vnd.oma.poc.detailed-progress-report+xml
application/vnd.oma.poc.optimized-progress-report+xml
a= accept-wrapped-types:text/plain
a= path:msrp://[50555::ccc:ddd:aaa:bbb];54321/ksdghafhdga45sdf2a;tcp
a= max-size:100000000

Included Media Content

Content-Type: text/directory;profile="vcard";charset=UTF-8

begin:vcard
fn:John P. Smith
n:Smith;John;Peter;Dr.;MBA
EMAIL:TYPE=internet:POC-UserB@networkA.net
version:3.0
end:vcard

Invited parties identity information

Content-Disposition: recipient-list-history;handling="optional"
Content-Type: application/resource-lists+xml

```

<?xml version="1.0" encoding="UTF-8"?>
<resource-lists
  xmlns="urn:ietf:params:xml:ns:resource-lists"
  xmlns:cc="urn:ietf:params:xml:ns:copycontrol"
>
  <list>
    <entry uri="sip:PoC-UserB@networkB.com" cc:copyControl="to"
cc:anonymize="true"/>
    <entry uri="sip:PoC-UserC@networkC.com;uriusage=user"
cc:copyControl="to" cc:anonymize="true"/>
    <entry uri="sip:PoC-UserD@networkD.com" cc:copyControl="to"
cc:anonymize="false"/>
  </list>
</resource-lists>

```

3. SIP INVITE request (from SIP/IP Core X to SIP/IP Core B)

SIP/IP Core X forwards the SIP INVITE request to SIP/IP Core B.

Request-URI	sip:PoC-UserB@networkB.net
SIP HEADERS	
P-Asserted-Identity:	"PoC User A" <sip:PoC-UserA@networkA.net>
Accept-Contact:	*,+g.poc.talkburst; require;explicit
User-Agent:	PoC-serv/OMA2.0
Referred-By:	"PoC User A" <sip:PoC-UserA@networkA.net>
Privacy:	id
Contact:	<sip:PoC-SessionABCDEF@PoC-ServerX.networkX.net;session=adhoc>; +g.poc.talkburst;isfocus;+g.poc.discretemedia
Supported:	100rel,norefersub,timer
Session-Expires:	1800
Allow:	INVITE,ACK,CANCEL,BYE,PRACK,UPDATE,REFER,MESSAGE,OPTIONS
Subject:	Let's talk
Alert-Info:	<http://publicweb.networkB.net/users/PoC- UserA@networkA.net/myFavouriteRingtone.wav>
Call-Info:	<http://publicweb.networkB.net/users/PoC-

UserA@networkA.net/myOwnPicture.jpg>;purpose=icon

Reject-Contact: sip.automata;sip.actor=msg-taker;require;explicit

Reject-Contact: sip.automata;sip.actor=principal;sip.description="poc recording device";require;explicit

SDP PARAMETERS

Content-Type: application/sdp

c= IN IP6 50555::ccc:ddd:aaa:bbb

a= poc-qoe:professional

m= audio 53456 RTP/AVP 97 98

a= rtpmap:97 AMR

a= rtpmap:98 EVRC/8000

a= rtcp:53080

i= speech

a= label:ll

a= a=upcc:0

m= Application 50000 udp TBCP

a= fmp: TBCP queuing=1; tb_priority=2; timestamp=1;multimedia=1;local_grant=1

a= floorid:0 mstrm:ll kk

m= video 7566 RTP/AVP 99

a= rtpmap:99 MP4V-ES

a= label:kk

a= a=upcc:0

m= message 54321 TCP/MSRP *

a= accept-types:message/cpim application/vnd.oma.poc.final-report+xml
application/vnd.oma.poc.detailed-progress-report+xml
application/vnd.oma.poc.optimized-progress-report+xml

a= accept-wrapped-types:text/plain

a= path:msrp://[50555::ccc:ddd:aaa:bbb]:54321/ksdgfjhafdga45sdf2a;tcp

a= max-size:100000000

Included Media Content

Content-Type: text/directory;profile="vcard";charset=UTF-8

```
begin:vcard
fn:John P. Smith
n:Smith;John;Peter;Dr.;MBA
EMAIL:TYPE=internet:POC-UserB@networkA.net
version:3.0
end:vcard
```

Invited parties identity information

Content-Disposition: recipient-list-history;handling="optional"

Content-Type: application/resource-lists+xml

```
<?xml version="1.0" encoding="UTF-8"?>
<resource-lists
  xmlns="urn:ietf:params:xml:ns:resource-lists"
  xmlns:cc="urn:ietf:params:xml:ns:copycontrol"
>
  <list>
    <entry uri="sip:PoC-UserB@networkB.com" cc:copyControl="to"
cc:anonymize="true"/>
    <entry uri="sip:PoC-UserC@networkC.com;uriusage=user"
cc:copyControl="to" cc:anonymize="true"/>
    <entry uri="sip:PoC-UserD@networkD.com" cc:copyControl="to"
cc:anonymize="false"/>
  </list>
</resource-lists>
```

4. SIP INVITE request (from SIP/IP Core B to PoC Server B)

SIP/IP Core B forwards the SIP INVITE request to PoC Server B.

Request-URI sip:PoC-UserB@networkB.net

SIP HEADERS

P-Asserted-Identity: "PoC User A" <sip:PoC-UserA@networkA.net>
Accept-Contact: *,+g.poc.talkburst; require;explicit
User-Agent: PoC-serv/OMA2.0
Referred-By: "PoC User A" <sip:PoC-UserA@networkA.net>
Privacy: id
Contact: <sip:PoC-SessionABCDEF@PoC-ServerX.networkX.net;session=adhoc>;
 +g.poc.talkburst;isfocus;+g.poc.discretemedia
Supported: 100rel,norefersub,timer
Session-Expires: 1800
Allow: INVITE,ACK,CANCEL,BYE,PRACK,UPDATE,REFER,MESSAGE,OPTIONS
Subject: Let's talk
Alert-Info: <http://publicweb.networkB.net/users/PoC-
 UserA@networkA.net/myFavouriteRingtone.wav>
Call-Info: <http://publicweb.networkB.net/users/PoC-
 UserA@networkA.net/myOwnPicture.jpg>;purpose=icon
Reject-Contact: sip.automata;sip.actor=msg-taker;require;explicit
Reject-Contact: sip.automata;sip.actor=principal;sip.description="poc recording
 device";require;explicit

SDP PARAMETERS

Content-Type: application/sdp

c= IN IP6 50555::ccc:ddd:aaa:bbb
a= poc-qoe:professional
m= audio 53456 RTP/AVP 97 98
a= rtpmap:97 AMR
a= rtpmap:98 EVRC/8000
a= rtcp:53080
i= speech
a= label:ll
a= a=upcc:0
m= Application 50000 udp TBCP
a= fntp:TBCP queuing=1; tb_priority=2; timestamp=1;multimedia=1;local_grant=1
a= floorid:0 mstrm:ll kk

m= video 7566 RTP/AVP 99
a= rtpmap:99 MP4V-ES
a= label:kk
a= a=upcc:0
m= message 54321 TCP/MSRP *
a= accept-types:message/cpim application/vnd.oma.poc.final-report+xml
 application/vnd.oma.poc.detailed-progress-report+xml
 application/vnd.oma.poc.optimized-progress-report+xml
a= accept-wrapped-types:text/plain
a= path:msrp://[50555::ccc:ddd:aaa:bbb];54321/ksdghafhdga45sdf2a;tcp
a= max-size:100000000

Included Media Content

Content-Type: text/directory;profile="vcard";charset=UTF-8

 begin:vcard
 fn:John P. Smith
 n:Smith;John;Peter;Dr.;MBA
 EMAIL:TYPE=internet:POC-UserB@networkA.net
 version:3.0
 end:vcard

Invited parties identity information

Content-Disposition: recipient-list-history;handling="optional"

Content-Type: application/resource-lists+xml

```

<?xml version="1.0" encoding="UTF-8"?>
<resource-lists
  xmlns="urn:ietf:params:xml:ns:resource-lists"
  xmlns:cc="urn:ietf:params:xml:ns:copycontrol"
>
  <list>
    <entry uri="sip:PoC-UserB@networkB.com" cc:copyControl="to"
  
```

```

cc:anonymize="true"/>
    <entry uri="sip:PoC-UserC@networkC.com;uriusage=user"
cc:copyControl="to" cc:anonymize="true"/>
    <entry uri="sip:PoC-UserD@networkD.com" cc:copyControl="to"
cc:anonymize="false"/>
</list>
</resource-lists>

```

5. SIP INVITE request (from PoC Server B to SIP/IP Core B)

PoC Server B sends a SIP INVITE request to SIP/IP Core B.

Request-URI	sip:PoC-UserB@networkB.net
SIP HEADERS	
P-Asserted-Identity:	"PoC User A" <sip:PoC-UserA@networkA.net>
Accept-Contact:	*;+g.poc.talkburst; require;explicit
User-Agent:	PoC-serv/OMA2.0
Privacy:	id
Contact:	<sip:PoC-SessionABCDEF@PoC_ServerB.networkB.net;session=adhoc>; +g.poc.talkburst;isfocus;+g.poc.discretemedia
Supported:	norefersub,timer
Session-Expires:	1800
Answer-Mode:	Auto
Allow:	INVITE,ACK,CANCEL,BYE,PRACK,UPDATE,REFER.MESSAGE,OPTIONS
Subject:	Let's talk
Alert-Info:	<http://publicweb.networkB.net/users/PoC- UserA@networkA.net/myFavouriteRingingTone.wav>
Call-Info:	<http://publicweb.networkB.net/users/PoC- UserA@networkA.net/myOwnPicture.jpg>;purpose=icon
Reject-Contact:	sip.automata;sip.actor=msg-taker;require;explicit
Reject-Contact:	sip.automata;sip.actor=principal;sip.description="poc recording device";require;explicit
SDP PARAMETERS	
c=	IN IP6 60333::ddd: ccc:aaa:bbb

a= poc-qoe:professional
m= audio 63776 RTP/AVP 98
a= rtpmap:98 EVRC/8000
a= rtcp:63090
i= speech
a= label:al
m= Application 60000 udp TBCP
a= fmp: TBCP queuing=1; tb_priority=2; timestamp=1;multimedia=1;local_grant=1
a= floorid:0 mstrm:al ak
m= video 47566 RTP/AVP 99
a= rtpmap:99 MP4V-ES
a= label:ak
a= a=upcc:0
m= message 44321 TCP/MSRP *
a= accept-types:message/cpim application/vnd.oma.poc.final-report+xml
application/vnd.oma.poc.detailed-progress-report+xml
application/vnd.oma.poc.optimized-progress-report+xml
a= accept-wrapped-types:text/plain
a= path:msrp://[60333::ddd:ccc:aaa:bbb]:44321/gsgsdfg4;tcp
a= max-size:100000000

Included Media Content

Content-Type: text/directory;profile="vcard";charset=UTF-8

```

begin:vcard
fn:John P. Smith
n:Smith;John;Peter;Dr.;MBA
EMAIL:TYPE=internet:POC-UserB@networkA.net
version:3.0
end:vcard

```

Invited parties identity information

Content-Disposition: recipient-list-history;handling="optional"

Content-Type: application/resource-lists+xml

```
<?xml version="1.0" encoding="UTF-8"?>
<resource-lists
  xmlns="urn:ietf:params:xml:ns:resource-lists"
  xmlns:cc="urn:ietf:params:xml:ns:copycontrol"
>
  <list>
    <entry uri="sip:PoC-UserD@networkD.com" cc:copyControl="to"
cc:anonymize="false"/>
    <entry uri="sip:anonymous@anonymous.invalid" cc:copyControl="to"
cc:count="2"/>
  </list>
</resource-lists>
```

6. SIP INVITE request (from SIP/IP Core B to PoC Client B)

SIP/IP Core B forwards the SIP INVITE request to PoC Client B.

Request-URI sip:PoC-UserB@networkB.net

SIP HEADERS

Accept-Contact: *,+g.poc.talkburst; require;explicit

User-Agent: PoC-serv/OMA2.0

Privacy: id

Contact: <sip:PoC-SessionABCDEF@PoC_ServerB.networkB.net;session=adhoc;>
<+g.poc.talkburst;isfocus;+g.poc.discretedia>

Supported: norefersub,timer

Session-Expires: 1800

Answer-Mode: Auto

Allow: INVITE,ACK,CANCEL,BYE,PRACK,UPDATE,REFER,MESSAGE,OPTIONS

Subject: Let's talk

Alert-Info: <http://publicweb.networkB.net/users/PoC-
UserA@networkA.net/myFavouriteRingtone.wav>

Call-Info: <http://publicweb.networkB.net/users/PoC-

UserA@networkA.net/myOwnPicture.jpg>;purpose=icon

Reject-Contact: sip.automata;sip.actor=msg-taker;require;explicit

Reject-Contact: sip.automata;sip.actor=principal;sip.description="poc recording device";require;explicit

SDP PARAMETERS

c= IN IP6 60333::ddd:ccc:aaa:bbb

a= poc-qoe:professional

m= audio 63776 RTP/AVP 98

a= rtpmap:98 EVRC/8000

a= rtcp:63090

i= speech

a= label:al

m= Application 60000 udp TBCP

a= fmp: TBCP queuing=1; tb_priority=2; timestamp=1;multimedia=1;local_grant=1

a= floorid:0 mstrm:al ak

m= video 47566 RTP/AVP 99

a= rtpmap:99 MP4V-ES

a= label:ak

a= a=upcc:0

m= message 44321 TCP/MSRP *

a= accept-types:message/cpim application/vnd.oma.poc.final-report+xml
application/vnd.oma.poc.detailed-progress-report+xml
application/vnd.oma.poc.optimized-progress-report+xml

a= accept-wrapped-types:text/plain

a= path:msrp://[60333::ddd:ccc:aaa:bbb]:44321/gsgsdfg4;tcp

a= max-size:100000000

Included Media Content

Content-Type: text/directory;profile="vcard";charset=UTF-8

begin:vcard

fn:John P. Smith

```

n:Smith;John;Peter;Dr.;MBA
EMAIL:TYPE=internet:POC-UserB@networkA.net
version:3.0
end:vcard

```

Invited parties identity information

Content-Disposition: recipient-list-history;handling="optional"
Content-Type: application/resource-lists+xml

```

<?xml version="1.0" encoding="UTF-8"?>
<resource-lists
  xmlns="urn:ietf:params:xml:ns:resource-lists"
  xmlns:cc="urn:ietf:params:xml:ns:copycontrol"
>
  <list>
    <entry uri="sip:PoC-UserD@networkD.com" cc:copyControl="to"
cc:anonymize="false"/>
    <entry uri="sip:anonymous@anonymous.invalid" cc:copyControl="to"
cc:count="2"/>
  </list>
</resource-lists>

```

7. SIP 183 "Session Progress" response (from PoC Server B to SIP/IP Core B)

PoC Server B sends a SIP 183 "Session Progress" response to SIP/IP Core B.

SIP HEADERS

P-Asserted-Identity: "PoC User B" <sip:PoC-UserB@networkB.net>
Privacy: id
Require: 100rel
Server: PoC-Serv/OMA2.0
Contact: <sip:PoC-SessionABCDEF@PoC-ServerB.networkB.net>;+g.poc.talkburst
P-Answer-State: Unconfirmed
Allow: INVITE,ACK,CANCEL,BYE,PRACK,UPDATE,

REFER,MESSAGE,OPTIONS

8. SIP 183 "Session Progress" response (from SIP/IP Core B to SIP/IP Core X)

SIP/IP Core B forwards the SIP 180 "Session Progress" response to SIP/IP Core X.

SIP HEADERS

P-Asserted-Identity: "PoC User B" <sip:PoC-tUserB@networkB.net>
Privacy: id
Require: 100rel
Server: PoC-Serv/OMA2.0
Contact: <sip:PoC-SessionABCDEF@PoC-ServerB.networkB.net>; +g.poc.talkburst
P-Answer-State: Unconfirmed
Allow: INVITE,ACK,CANCEL,BYE,PRACK,UPDATE, REFER,MESSAGE, OPTIONS

9. SIP 183 "Session Progress" response (from SIP/IP Core X to PoC Server X)

SIP/IP Core X forwards the SIP 183 "Session Progress" response to PoC Server X.

SIP HEADERS

P-Asserted-Identity: "PoC User B" <sip:PoC-UserB@networkB.net>
Privacy: id
Require: 100rel
Server: PoC-Serv/OMA2.0
Contact: <sip:PoC-SessionABCDEF@PoC-ServerB.networkB.net>; +g.poc.talkburst
P-Answer-State: Unconfirmed
Allow: INVITE,ACK,CANCEL,BYE,PRACK,UPDATE,REFER,MESSAGE, OPTIONS

10. SIP PRACK request (from PoC Server X to SIP/IP Core X)

If PoC Server B requested SIP 183 "Session progress" response to be sent reliably, PoC Server X sends a SIP PRACK request to the SIP/IP Core X.

Request-URI sip:PoC-SessionABCDEF@PoC-ServerB.networkB.net

11. SIP PRACK request (from SIP/IP Core X to SIP/IP Core B)

SIP/IP Core X forwards the SIP PRACK request to SIP/IP Core B.

Request-URI sip:PoC-SessionABCDEF@PoC-ServerB.networkB.net

12. SIP PRACK request (from SIP/IP Core B to PoC Server B)

SIP/IP Core B forwards SIP PRACK request to PoC Server B.

Request-URI sip:PoC-SessionABCDEF@PoC-ServerB.networkB.net

13. SIP 200 "OK" response to the SIP PRACK request (from PoC Server B to SIP/IP Core B)

PoC Server B sends a SIP 200 "OK" response to SIP/IP Core B.

14. SIP 200 "OK" response to the SIP PRACK request (from SIP/IP Core B to SIP/IP Core X)

SIP/IP Core B forwards the SIP 200 "OK" response to SIP/IP core X.

15. SIP 200 "OK" response to the SIP PRACK request (from SIP/IP Core X to PoC Server X)

SIP/IP Core X forwards the SIP 200 "OK" response to PoC Server X.

16. SIP 200 "OK" response to the SIP INVITE request (from PoC Client B to SIP/IP Core B)

PoC Client B sends a SIP 200 "OK" response to SIP/IP Core B. PoC User B is not allowed to use Professional QoE Profile because he is subscribed to Premium QoE Profile.

SIP HEADERS

P-Preferred-Identity: "PoC User B"<sip:PoC-ClientB.networkB.net>
Privacy: id
Server: PoC-client/OMA2.0 Acme-Talk5000/v1.01
Contact: <sip:PoC-ClientB.networkB.net >;+sip.instance="<urn:uuid:00000000-0000-1000-8000-000A95A0E128>";+g.poc.talkburstst;+g.poc.fdcfo;+g.poc.discretedia
Require: timer
Session-Expires: 1800;refresher=uas
Allow: INVITE,ACK,CANCEL,BYE,REFER,MESSAGE,OPTIONS

SDP PARAMETERS

c= IN IP6 75555::eee:aaa:fff:bbb
a= poc-qoe:premium
m= audio 75575 RTP/AVP 98
a= rtpmap:98 EVRC/8000

```

a=                rtcp:75000
i=                speech
a=                label:bl
b=                AS:25.4
m=                application 75590 udp TBCP
a=                fmtp:TBCP queuing=1; tb_priority=2;timestamp=1;multimedia=1;local_grant=1
a=                floorid:0 mstrm:bl bk
m=                video 47888 RTP/AVP 99
a=                rtpmap:99 MP4V-ES
a=                label:bk
a=                a=upcc:0
m=                message 22335 TCP/MSRP *
a=                accept-types:message/cpim application/vnd.oma.poc.final-report+xml
                  application/vnd.oma.poc.detailed-progress-report+xml
                  application/vnd.oma.poc.optimized-progress-report+xml
a=                accept-wrapped-types:text/plain
a=                path:msrp://[75555::eee:aaa:fff:bbb]:22335/45yzxcasd;tcp
a=                max-size:20000

```

17. SIP 200 "OK" response to the SIP INVITE request (from SIP/IP Core B to PoC Server B)

SIP/IP Core B forwards the SIP 200 "OK" response to PoC Server B.

SIP HEADERS

```

P-Asserted-Identity:    <sip:PoC-UserB@networkB.net>
Privacy:                id
Server:                 PoC-client/OMA2.0 Acme-Talk5000/v1.01
Contact:                <sip:PoC-ClientB.networkB.net >;+sip.instance="<urn:uuid:00000000-0000-
                            1000-8000-
                            000A95A0E128>";+g.poc.talkburst;+g.poc.fdcfo;+g.poc.discretedia
Require:                timer
Session-Expires:       1800;refresher=uas
Allow:                  INVITE,ACK,CANCEL,BYE,REFER,MESSAGE,OPTIONS
Accept-Language:       en

```

SDP PARAMETERS

c= IN IP6 75555::eee:aaa:fff:bbb
a= poc-qoe:premium
m= audio 75575 RTP/AVP 98
a= rtpmap:98 EVRC/8000
a= rtcp:75000
i= speech
a= label:bl
b= AS:25.4
m= application 75590 udp TBCP
a= fmp: TBCP queuing=1; tb_priority=2;timestamp=1;multimedia=1;local_grant=1
a= floorid:0 mstrm:bl bk
m= video 47888 RTP/AVP 99
a= rtpmap:99 MP4V-ES
a= label:bk
a= a=upcc:0
m= message 22335 TCP/MSRP *
a= accept-types:message/cpim application/vnd.oma.poc.final-report+xml
application/vnd.oma.poc.detailed-progress-report+xml
application/vnd.oma.poc.optimized-progress-report+xml
a= accept-wrapped-types:text/plain
a= path:msrp://[75555::eee:aaa:fff:bbb]:22335/45yzxcasd;tcp
a= max-size:20000

18. SIP 200 "OK" response to the SIP INVITE request (from PoC Server B to SIP/IP Core B)

PoC Server B sends a SIP 200 "OK" response to SIP/IP Core B.

SIP HEADERS

P-Asserted-Identity: "PoC User B" <sip:PoC-UserB@networkB.net>
Privacy: id
Require: timer
Session-Expires: 1800;refresher=uas
Server: PoC-Serv/OMA2.0

Contact: <sip:PoC-SessionABCDEF@PoC-ServerB.networkB.net;b2bua>;+g.poc.talkburst;+g.poc.fdcfo;+g.poc.discretemedia

Accept-Language: en

SDP PARAMETERS

c= IN IP6 99055::fff:aaa:eee:bbb
a= poc-qoe:premium
m= audio 59006 RTP/AVP 98
a= rtpmap:98 EVRC/8000
a= rtcp:50000
i= speech
b= AS:25.4
a= label:uu
a= a=upcc:0
m= application 50000 udp TBCP
a= fmp: TBCP queuing=1; tb_priority=2;timestamp=1;multimedia=1;local_grant=1
a= floorid:0 mstrm:uu vv
m= video 17566 RTP/AVP 99
a= rtpmap:99 MP4V-ES
b= AS:75
a= label:vv
a= a=upcc:0
m= message 43821 TCP/MSRP *
a= accept-types:message/cpim application/vnd.oma.poc.final-report+xml
application/vnd.oma.poc.detailed-progress-report+xml
application/vnd.oma.poc.optimized-progress-report+xml
a= accept-wrapped-types:text/plain
a= path:msrp://[99055::fff:aaa:eee:bbb]:43821/xk83a45;tcp
a= max-size:10000

19. SIP 200 "OK" response to the SIP INVITE request (from SIP/IP Core B to SIP/IP Core X)

SIP/IP Core B forwards the SIP 200 "OK" response to SIP/IP Core X.

SIP HEADERS

P-Asserted-Identity: "PoC User B" <sip:PoC-UserB@networkB.net>
Privacy: id
Require: timer
Session-Expires: 1800;refresher=uas
Server: PoC-Serv/OMA2.0
Contact: <sip:PoC-SessionABCDEF@PoC-ServerB.networkB.net;b2bua>;+g.poc.talkburst;+g.poc.fdcfo;+g.poc.discretemedia
Accept-Language: en

SDP PARAMETERS

c= IN IP6 99055::fff:aaa:eee:bbb
 a= poc-qoe:premium
 m= audio 59006 RTP/AVP 98
 a= rtpmap:98 EVRC/8000
 a= rtcp:50000
 i= speech
 b= AS:25.4
 a= label:uu
 a= a=upcc:0
 m= application 50000 udp TBCP
 a= fmtp:TBCP queuing=1; tb_priority=2;timestamp=1;multimedia=1;local_grant=1
 a= floorid:0 mstrm:uu vv
 m= video 17566 RTP/AVP 99
 a= rtpmap:99 MP4V-ES
 b= AS:75
 a= label:vv
 a= a=upcc:0
 m= message 43821 TCP/MSRP *
 a= accept-types:message/cpim application/vnd.oma.poc.final-report+xml
 application/vnd.oma.poc.detailed-progress-report+xml
 application/vnd.oma.poc.optimized-progress-report+xml
 a= accept-wrapped-types:text/plain
 a= path:msrp://[99055::fff:aaa:eee:bbb]:43821/xk83a45;tcp

a= max-size:10000

20. SIP 200 "OK" response to the SIP INVITE request (from SIP/IP Core X to PoC Server X)

SIP/IP Core X forwards the SIP 200 "OK" response to PoC Server X.

SIP HEADERS

P-Asserted-Identity: "PoC User B" <sip:PoC-UserB@networkB.net>
Privacy: id
Require: timer
Session-Expires: 1800;refresher=uas
Server: PoC-Serv/OMA2.0
Contact: <sip:PoC-SessionABCDEF@PoC-ServerB.networkB.net;b2bua>;+g.poc.talkburst;+g.poc.fdcfo;+g.poc.discretemedia

SDP PARAMETERS

c= IN IP6 99055::fff:aaa:eee:bbb
a= poc-qoe:premium
m= audio 59006 RTP/AVP 98
a= rtpmap:98 EVRC/8000
a= rtcp:50000
i= speech
b= AS:25.4
a= label:uu
a= a=upcc:0
m= application 50000 udp TBCP
a= fmp: TBCP queuing=1; tb_priority=2;timestamp=1;multimedia=1;local_grant=1
a= floorid:0 mstrm:uu vv
m= video 17566 RTP/AVP 99
a= rtpmap:99 MP4V-ES
b= AS:75
a= label:vv
a= a=upcc:0
m= message 43821 TCP/MSRP *

```

a=          accept-types:message/cpim application/vnd.oma.poc.final-report+xml
           application/vnd.oma.poc.detailed-progress-report+xml
           application/vnd.oma.poc.optimized-progress-report+xml

a=          accept-wrapped-types:text/plain

a=          path:msrp://[99055::fff:aaa:eee:bbb]:43821/xk83a45;tcp

a=          max-size:10000

```

A. MBCP Media Burst Taken message (from the PoC Server X to the PoC Server B).

The MBCP Media Burst Taken message is sent to inform the PoC Client B that another PoC Client has been granted to send a Media Burst. The message contains the identity of PoC User at the granted PoC Client.

B. MBCP Media Burst Taken message (from the PoC Server B to the PoC Client B).

The MBCP Media Burst Taken message is sent to inform the PoC Client B that another PoC Client has been granted to send a Media Burst. The message contains the identity of PoC User at the granted PoC Client.

21. SIP ACK request (from PoC Server X to SIP/IP Core X)

PoC Server X sends a SIP ACK request to SIP/IP Core X.

22. SIP ACK request (from SIP/IP Core X to SIP/IP Core B)

SIP/IP Core X forwards the SIP ACK request to SIP/IP Core B.

23. SIP ACK request (from SIP/IP Core B to PoC Server B)

SIP/IP Core B forwards the SIP ACK request to PoC Server B.

24. SIP ACK request (from PoC Server B to SIP/IP Core B)

PoC Server B sends a SIP ACK request to SIP/IP Core B.

25. SIP ACK request (from SIP/IP Core B to PoC Client B)

SIP/IP Core B forwards the SIP ACK request to PoC Client B.

F.6 Rejoin a Pre-arranged PoC Group Session

F.6.1 Using on-demand signaling

The signaling flow is valid for rejoining a Pre-arranged PoC Group Session.

Prerequisites for the signaling flow are that the PoC Client has previously been a Participant in the Pre-arranged PoC Group Session and that the Pre-arranged PoC Group Session is still ongoing.

The PoC Media Traffic Optimisation is used between the PoC Server A and PoC Server X.

The QoE Profile assigned to the Pre-arranged PoC Group Session is the 'Premium' QoE Profile. The PoC Client A requests 'Premium' as the Local QoE Profile.

Figure 12 "Rejoin a Pre-arranged PoC Group Session" shows the message flow for the scenario.

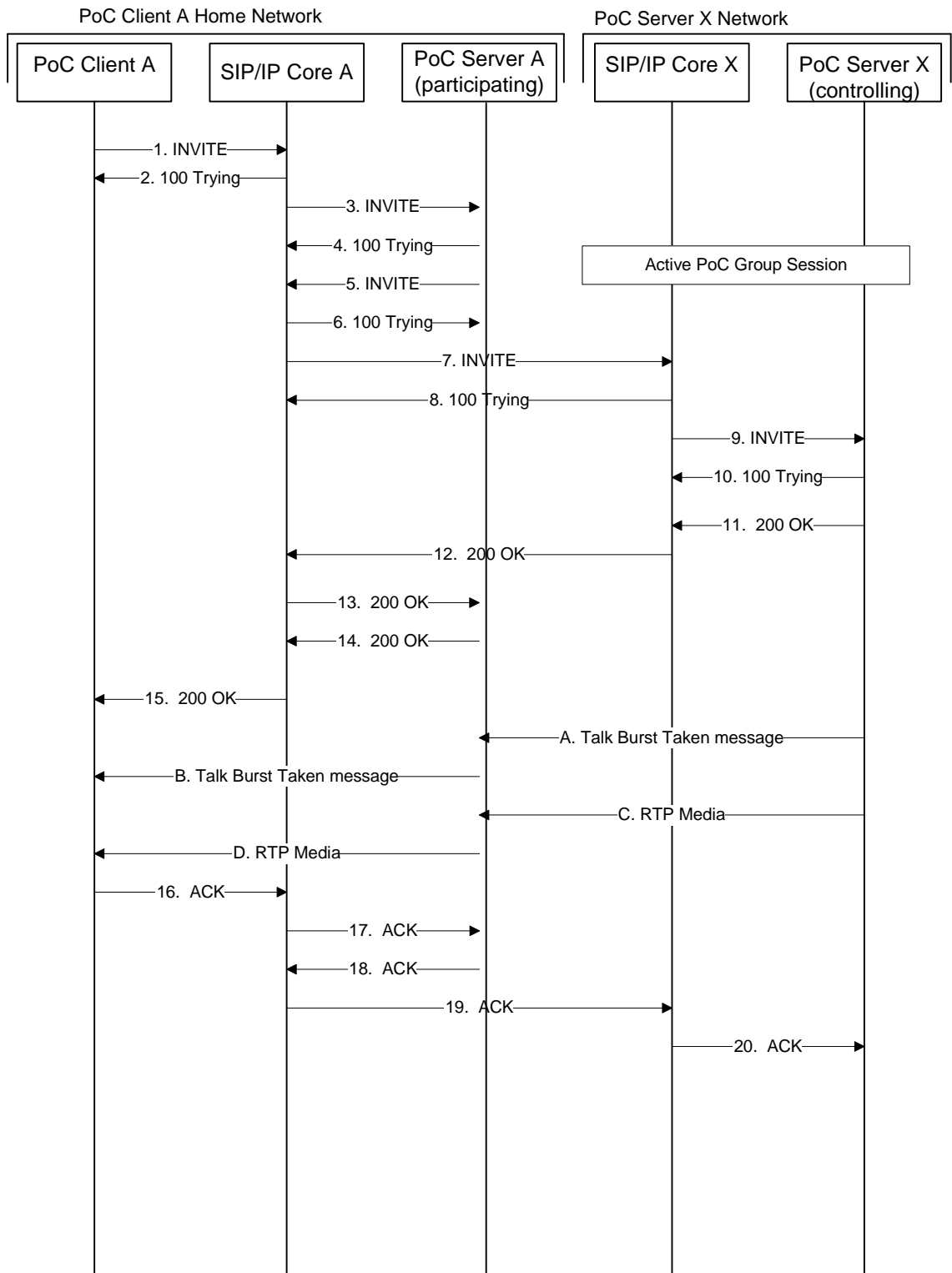

Figure 12: Rejoin a Pre-arranged PoC Group Session

The steps of the flows are as follows:

1. SIP INVITE request (from PoC Client A to SIP/IP Core A)

The PoC Client receives a request from a PoC User to rejoin a Pre-arranged PoC Group Session and sends a SIP INVITE request to the SIP/IP Core A. The SIP INVITE request includes the PoC Session Identity in the Request-URI.

Request-URI sip:PoC-SessionABCDEF@PoC-ServerA.networkA.net;session=prearranged

SIP HEADERS

P-Preferred-Identity: "PoC User A" <sip:PoC-UserA@networkA.net>
Accept-Contact: *,+g.poc.talkburst; require;explicit
User-Agent: PoC-client/OMA2.0 Acme-Talk5000/v1.01
Privacy: id
Contact: <sip:PoC-ClientA@networkA.net>;+sip.instance="<urn:uuid:00000000-0000-1000-8000-000A95A0E128>";+g.poc.talkburst; +g.poc.fdcfo; +g.poc.discretemedia
Supported: timer
Session-Expires: 1800;refresher=uac
Allow: INVITE,ACK,CANCEL,BYE,REFER,MESSAGE,SUBSCRIBE, NOTIFY,PUBLISH,OPTIONS
Accept-Language en

SDP PARAMETERS

c= IN IP6 5555::aaa:bbb:ccc:ddd
a= poc-qoe:premium
m= audio 3456 RTP/AVP 97
a= Rtpmap:97 AMR
a= rtcp:5560
i speech
b AS:25.4
a label:aa
m= application 2000 udp TBCP
a= fmp: TBCP queuing=1; tb_priority=2; timestamp=1; multimedia=1; mbc_scheme="random"; tb_txbw=64; poc_sess_priority=1;local_grant=1; imp_mb_req=0
a= floorid:0 mstrm:aa bb
m= video 3456 RTP/AVP 99

a= rtpmap:99 MP4V-ES
b= AS:75
a= label:bb
m= message 12345 TCP/MSRP *
a= accept-types:message/cpim application/vnd.oma.poc.final-report+xml
 application/vnd.oma.poc.detailed-progress-report+xml
 application/vnd.oma.poc.optimized-progress-report+xml
a= accept-wrapped-types:text/plain
a= path:msrp://[5555::aaa:bbb:ccc:ddd]:12345/kjhd37s2s20w2a;tcp
a= max-size:10000

2. SIP 100 "Trying" response (from SIP/IP Core A to PoC Client A)

The SIP/IP Core A sends a SIP 100 "Trying" response to the PoC Client A.

3. SIP INVITE request (from SIP/IP Core A to PoC Server A)

The SIP/IP Core A sends the SIP INVITE request to the PoC Server A.

Request-URI sip:PoC-SessionABCDEF@PoC-ServerA.networkA.net;session=prearranged

SIP HEADERS

P-Asserted-Identity: "PoC User A" <sip:PoC-UserA@networkA.net>
Accept-Contact: *,+g.poc.talkburst; require;explicit
User-Agent: PoC-client/OMA2.0 Acme-Talk5000/v1.01
Privacy: id
Contact: <sip:PoC-ClientA@networkA.net>;+sip.instance="<urn:uuid:00000000-0000-1000-8000-000A95A0E128>";+g.poc.talkburst; +g.poc.fdcfo; +g.poc.discretemedia
Supported: timer
Session-Expires: 1800;refresher=uac
Allow: INVITE,ACK,CANCEL,BYE,REFER,MESSAGE,SUBSCRIBE, NOTIFY,PUBLISH,OPTIONS
Accept-Language en

SDP PARAMETERS

```

c=                IN IP6 5555::aaa:bbb:ccc:ddd
a=                poc-qoe:premium
m=                audio 3456 RTP/AVP 97
a=                Rtpmap:97 AMR
a=                rtcp:5560
i=                speech
b=                AS:25.4
a=                label:aa
m=                application 2000 udp TBCP
a=                fmp: TBCP queuing=1; tb_priority=1; timestamp=1; multimedia=1;
                 mbc_scheme="random"; tb_txbw=64; poc_sess_priority=1; local_grant=1;
                 imp_mb_req=0;
a=                floorid:0 mstrm:aa bb
m=                video 3456 RTP/AVP 99
a=                rtpmap:99 MP4V-ES
b=                AS:75
a=                label:bb
m=                message 12345 TCP/MSRP *
a=                accept-types:message/cpim application/vnd.oma.poc.final-report+xml
                 application/vnd.oma.poc.detailed-progress-report+xml
                 application/vnd.oma.poc.optimized-progress-report+xml
a=                accept-wrapped-types:text/plain
a=                path:msrp://[5555::aaa:bbb:ccc:ddd]:12345/kjhd37s2s20w2a;tcp
a=                max-size:10000

```

4. SIP 100 "Trying" response (from PoC Server A to SIP/IP Core A)

The PoC Server A sends a SIP 100 "Trying" response to the SIP/IP Core A.

5. SIP INVITE request (from PoC Server A to SIP/IP Core A)

Using the PoC Session Identity the PoC Server A determines that the Pre-arranged PoC Group Session is owned by another PoC Server and sends the SIP INVITE request to the SIP/IP Core A. The SIP INVITE request includes the PoC Session Identity in the Request-URI.

```
Request-URI       sip: PoC-SessionABCDEF@PoC-ServerX.networkX.net;session=prearranged
```

SIP HEADERS

P-Asserted-Identity: "PoC User A" <sip:PoC-UserA@networkA.net>
Accept-Contact: *,+g.poc.talkburst; require;explicit
User-Agent: PoC-serv/OMA2.0
Privacy: id
Contact: <sip:PoC-SessionABCDEF@PoC-ServerA.networkA.net>;+g.poc.talkburst;
 +g.poc.fdcfo; +g.poc.discretemedia; b2bua
Supported: timer
Session-Expires: 1800;refresher=uac
Allow: INVITE,ACK,CANCEL,BYE,REFER,MESSAGE,SUBSCRIBE,
 NOTIFY,PUBLISH,OPTIONS
Accept-Language en

SDP PARAMETERS

c= IN IP6 50555::ccc:ddd:aaa:bbb
a= poc-qoe:premium
m= audio 53456 RTP/AVP 97 98
a= Rtpmap:97 AMR
a= Rtpmap:98 EVRC/8000
a= rtcp:53080
i= speech
b= AS:25.4
a= label:aa
a= upcc:0
a= sendonly
m= Application 50000 udp TBCP
a= fmp: TBCP queuing=1; tb_priority=1; timestamp=1; multimedia=1;
 mbc_scheme="random"; tb_txbw=64; poc_sess_priority=1; local_grant=1;
 imp_mb_req=0
a= floorid:0 mstrm:aa bb
m= video 53456 RTP/AVP 99
a= rtpmap:99 MP4V-ES
b= AS:75
a= label:bb
a= upcc:0

a= sendonly
m= message 54321 TCP/MSRP *
a= accept-types:message/cpim application/vnd.oma.poc.final-report+xml
 application/vnd.oma.poc.detailed-progress-report+xml
 application/vnd.oma.poc.optimized-progress-report+xml
a= accept-wrapped-types:text/plain
a= path:msrp://[50555::ccc:ddd:aaa:bbb]:54321/kjhd37p4z789w1;tcp
a= max-size:10000

6. SIP 100 "Trying" response (from SIP/IP Core A to PoC Server A)

The SIP/IP Core A sends a SIP 100 "Trying" response to the PoC Server A.

7. SIP INVITE request (from SIP/IP Core A to SIP/IP Core X)

Based on the PoC Session Identity in the Request-URI the SIP/IP Core A sends the SIP INVITE request to the SIP/IP Core X.

Request-URI sip: PoC-SessionABCDEF@PoC-ServerX.networkX.net;session=prearranged

SIP HEADERS

P-Asserted-Identity: "PoC User A" <sip:PoC-UserA@networkA.net>
Accept-Contact: *,+g.poc.talkburst; require;explicit
User-Agent: PoC-serv/OMA2.0
Privacy: id
Contact: <sip: PoC-SessionABCDEF@PoC-ServerA.networkA.net>;+g.poc.talkburst;
 +g.poc.discretemedia; +g.poc.fdcfo; b2bua
Supported: timer
Session-Expires: 1800;refresher=uac
Allow: INVITE,ACK,CANCEL,BYE,REFER,MESSAGE,SUBSCRIBE,
 NOTIFY,PUBLISH,OPTIONS
Accept-Language en

SDP PARAMETERS

c= IN IP6 50555::ccc:ddd:aaa:bbb
a= poc-qoe:premium
m= audio 53456 RTP/AVP 97 98
a= Rtpmap:97 AMR

```

a=          Rtpmap:98 EVRC/8000
a=          rtcp:53080
i=          speech
b=          AS:25.4
a=          label:aa
a=          upcc:0
a=          sendonly
m=          Application 50000 udp TBCP
a=          fmtp:TBCP queuing=1; tb_priority=1; timestamp=1; multimedia=1;
           mbc_scheme="random"; tb_txbw=64; poc_sess_priority=1; local_grant=1;
           imp_mb_req=0
a=          floorid:0 mstrm:aa bb
m=          video 53456 RTP/AVP 99
a=          rtpmap:99 MP4V-ES
b=          AS:75
a=          label:bb
a=          upcc:0
a=          sendonly
m=          message 54321 TCP/MSRP *
a=          accept-types:message/cpim application/vnd.oma.poc.final-report+xml
           application/vnd.oma.poc.detailed-progress-report+xml
           application/vnd.oma.poc.optimized-progress-report+xml
a=          accept-wrapped-types:text/plain
a=          path:msrp://[50555::ccc:ddd:aaa:bbb]:54321/kjhd37p4z789w1;tcp
a=          max-size:10000

```

8. SIP 100 "Trying" response (from SIP/IP Core X to SIP/IP Core A)

The SIP/IP Core X sends a SIP 100 "Trying" response to the SIP/IP Core A.

9. SIP INVITE request (from SIP/IP Core X to PoC Server X)

The SIP/IP Core X sends the SIP INVITE request to the PoC Server X.

Request-URI sip:PoC-SessionABCDEF@PoC-ServerX.networkX.net;session=prearranged

SIP HEADERS

P-Asserted-Identity: "PoC User A" <sip:PoC-UserA@networkA.net>
Accept-Contact: *,+g.poc.talkburst; require;explicit
User-Agent: PoC-serv/OMA2.0
Privacy: id
Contact: <sip: PoC-SessionABCDEF@PoC-
 ServerA.networkA.net>;+g.poc.talkburst+g.poc.discretemedia; +g.poc.fdcfo;
 b2bua
Supported: timer
Session-Expires: 1800;refresher=uac
Allow: INVITE,ACK,CANCEL,BYE,REFER,MESSAGE,SUBSCRIBE,
 NOTIFY,PUBLISH,OPTIONS
Accept-Language en

SDP PARAMETERS

c= IN IP6 50555::ccc:ddd:aaa:bbb
a= poc-qoe:premium
m= audio 53456 RTP/AVP 97 98
a= Rtpmap:97 AMR
a= Rtpmap:98 EVRC/8000
a= rtcp:53080
i= speech
b= AS:25.4
a= label:aa
a= upcc:0
a= sendonly
m= Application 50000 udp TBCP
a= fntp:TBCP queuing=1; tb_priority=1; timestamp=1; multimedia=1;
 mbc_scheme="random"; tb_txbw=64; poc_sess_priority=1; local_grant=1;
 imp_mb_req=0
a= floorid:0 mstrm:aa bb
m= video 53456 RTP/AVP 99
a= rtpmap:99 MP4V-ES
b= AS:75
a= label:bb

```

a=          upcc:0
a=          sendonly
m=          message 54321 TCP/MSRP *
a=          accept-types:message/cpim application/vnd.oma.poc.final-report+xml
            application/vnd.oma.poc.detailed-progress-report+xml
            application/vnd.oma.poc.optimized-progress-report+xml
a=          accept-wrapped-types:text/plain
a=          path:msrp://[50555::ccc:ddd:aaa:bbb]:54321/kjhd37p4z789w1;tcp
a=          max-size:10000

```

10. SIP 100 "Trying" response (from PoC Server X to SIP/IP Core X)

The PoC Server X sends the SIP 100 "Trying" response to the SIP/IP Core X.

11. SIP 200 "OK" response (from PoC Server X to SIP/IP Core X)

The PoC Server X authorizes the PoC Client A to rejoin to the Pre-arranged PoC Group Session and sends the SIP 200 "OK" response to the SIP/IP Core X.

SIP HEADERS

```

P-Asserted-Identity: "OMA Golf Buddies" <sip:OMA-Golf-buddies
                    @networkX.net;session=prearranged>
Contact:             <sip:PoC-SessionABCDEF%PoC-SessionABCDEF@PoC-
                    ServerX.net% @networkX.net;session=prearranged>;+g.poc.talkburst;isfocus
Server:              PoC-serv/OMA2.0
Require:             timer
Session-Expires:    1800;refresher=uac
Allow:               INVITE,ACK,CANCEL,BYE,PRACK, UPDATE,
                    REFER,MESSAGE,SUBSCRIBE, NOTIFY,PUBLISH,OPTIONS
Supported:           norefersub

```

SDP PARAMETERS

```

c=          IN IP6 9666::eee: aaa:bbb:fff
a=          poc-qoe:premium
m=          audio 9652 RTP/AVP 98
a=          Rtpmap:98 EVRC/8000
a=          rtcp:9600
a=          upcc:0

```

```

a=          recvonly
i=          speech
a=          label:aa
m=          application 9600 udp TBCP
a=          fmtp:TBCP queuing=1; tb_priority=1; timestamp=1; multimedia=1;
           mbc_scheme="random"; tb_txbw=64; poc_sess_priority=1; local_grant=1;
           imp_mb_req=0
a=          floorid:0 mstrm:aa bb
m=          video 9652 RTP/AVP 93
a=          rtpmap:93 MP4V-ES
a=          label:bb
a=          upcc:0
a=          recvonly
m=          message 18912 TCP/MSRP *
a=          accept-types:message/cpim application/vnd.oma.poc.final-report+xml
           application/vnd.oma.poc.detailed-progress-report+xml
           application/vnd.oma.poc.optimized-progress-report+xml
a=          accept-wrapped-types:text/plain
a=          path:msrp://[9666:: eec:aaa:bbb:fff]:18912/zrtopxW45;tcp
a=          max-size:64000

```

12. SIP 200 "OK" response (from SIP/IP Core X to SIP/IP Core A)

The SIP/IP Core X sends the SIP 200 "OK" response to the SIP/IP Core A.

SIP HEADERS

P-Asserted-Identity: "OMA Golf Buddies" <sip:OMA-Golf-buddies@networkX.net;session=prearranged>

Contact <sip: PoC-SessionABCDEF@PoC-ServerX.networkX.net;session=prearranged>;+g.poc.talkburst;isfocus

Server: PoC-serv/OMA2.0

Require: timer

Session-Expires: 1800;refresher=uac

Allow: INVITE,ACK,CANCEL,BYE,PRACK, UPDATE, REFER,MESSAGE,SUBSCRIBE, NOTIFY,PUBLISH,OPTIONS

Supported: norefersub

SDP PARAMETERS

c= IN IP6 9666::eee:aaa:bbb:fff

a= poc-qoe:premium

m= audio 96525 RTP/AVP 98

a= Rtpmap:98 EVRC/8000

a= rtcp:9600

a= upcc:0

i= speech

a= recvonly

a= label:aa

m= application 9600 udp TBCP

a= fmp: TBCP queuing=1; tb_priority=1; timestamp=1; multimedia=1;
mbc_scheme="random"; tb_txbw=64; poc_sess_priority=1; local_grant=1;
imp_mb_req=0

a= floorid:0 mstrm:aa bb

m= video 9652 RTP/AVP 93

a= rtpmap:93 MP4V-ES

b= AS:75

a= label:bb

a= upcc:0

a= recvonly

m= message 18912 TCP/MSRP *

a= accept-types:message/cpim application/vnd.oma.poc.final-report+xml
application/vnd.oma.poc.detailed-progress-report+xml
application/vnd.oma.poc.optimized-progress-report+xml

a= accept-wrapped-types:text/plain

a= path:msrp://[9666::eee:aaa:bbb:fff]:18912/zrtopxW45;tcp

a= max-size:64000

13. SIP 200 "OK" response (from SIP/IP Core A to PoC Server A)

The SIP/IP Core A sends the SIP 200 "OK" response to the PoC Server A.

SIP HEADERS

P-Asserted-Identity: "OMA Golf Buddies" <sip:OMA-Golf-buddies@networkX.net;session=prearranged>
Contact <sip: PoC-SessionABCDEF@PoC-ServerX.networkX.net;session=prearranged>;+g.poc.talkburst;isfocus
Server: PoC-serv/OMA2.0
Require: timer
Session-Expires: 1800;refresher=uac
Allow: INVITE,ACK,CANCEL,BYE,PRACK, UPDATE, REFER,MESSAGE,SUBSCRIBE, NOTIFY,PUBLISH,OPTIONS
Supported: norefersub

SDP PARAMETERS

c= IN IP6 9666::eee: aaa:bbb:fff
 a= poc-qoe:premium
 m= audio 96525 RTP/AVP 98
 a= Rtpmap:98 EVRC/8000
 a= rtcp:9600
 m= application 9600 udp TBCP
 a= fmp: TBCP queuing=1; tb_priority=1; timestamp=1; multimedia=1; mbc_scheme="random"; tb_txbw=64; poc_sess_priority=1; local_grant=1; imp_mb_req=0
 a= floorid:0 mstrm:aa bb
 m= video 9652 RTP/AVP 93
 a= rtpmap:93 MP4V-ES
 a= label:bb
 a= upcc:0
 a= recvonly
 m= message 18912 TCP/MSRP *
 a= accept-types:message/cpim application/vnd.oma.poc.final-report+xml application/vnd.oma.poc.detailed-progress-report+xml application/vnd.oma.poc.optimized-progress-report+xml
 a= accept-wrapped-types:text/plain
 a= path:msrp://[9666::eee:aaa:bbb:fff]:18912/zrtopxW45;tcp
 a= max-size:64000

14. SIP 200 "OK" response (from PoC Server A to SIP/IP Core A)

The PoC Server A sends the SIP 200 "OK" response to SIP/IP Core A.

SIP HEADERS

P-Asserted-Identity: "OMA Golf Buddies" <sip:OMA-Golf-buddies@networkX.net;session=prearranged>

Contact <sip:PoC-SessionABCDEF@PoC-ServerA.networkA.net;session=prearranged>;+g.poc.talkburst;isFocus

Server: PoC-serv/OMA2.0

Require: timer

Session-Expires: 1800;refresher=uac

Allow: INVITE,ACK,CANCEL,BYE,PRACK, UPDATE, REFER,MESSAGE,SUBSCRIBE, NOTIFY,PUBLISH,OPTIONS

Supported: norefersub

SDP PARAMETERS

c= IN IP6 57777::eee:fff:aaa:bbb

a= poc-qoe:premium

m= audio 57787 RTP/AVP 98

a= Rtpmap:98 EVRC/8000

a= rtcp:57000

i= speech

a= label:aa

m= application 57790 udp TBCP

a= fmp: TBCP queuing=1; tb_priority=1; timestamp=1; multimedia=1; mbc_scheme="random"; tb_txbw=64; poc_sess_priority=1; local_grant=1; imp_mb_req=0;

m= video 57787 RTP/AVP 93

a= rtpmap:93 MP4V-ES

a= label:bb

m= message 23456 TCP/MSRP *

a= accept-types:message/cpim application/vnd.oma.poc.final-report+xml application/vnd.oma.poc.detailed-progress-report+xml application/vnd.oma.poc.optimized-progress-report+xml

a= accept-wrapped-types:text/plain

a= path:msrp://[57777::eee:fff:aaa:bbb]:23456/12wzz1K92w5;tcp
a= max-size:64000

15. SIP 200 "OK" response (from SIP/IP Core A to PoC Client A)

The SIP/IP Core A sends the SIP 200 "OK" response to the PoC Client A.

SIP HEADERS

P-Asserted-Identity: "OMA Golf Buddies" <sip:OMA-Golf-buddies@networkX.net;session=prearranged>
Contact <sip:PoC-SessionABCDEF@PoC-ServerA.networkA.net;session=prearranged>;+g.poc.talkburst; isFocus
Server: PoC-serv/OMA2.0
Require: timer
Session-Expires: 1800;refresher=uac
Allow: INVITE,ACK,CANCEL,BYE,PRACK, UPDATE, REFER,MESSAGE,SUBSCRIBE, NOTIFY,PUBLISH,OPTIONS
Supported: norefersub

SDP PARAMETERS

c= IN IP6 57777::eee:fff:aaa:bbb
a= poc-qoe:premium
m= audio 57787 RTP/AVP 98
a= Rtpmap:98 EVRC/8000
a= rtcp:57000
i= speech
a= label:aa
m= application 57790 udp TBCP
a= fmp: TBCP queuing=1; tb_priority=1; timestamp=1; multimedia=1; mbc_scheme="random"; tb_txbw=64; poc_sess_priority=1; local_grant=1; imp_mb_req=0;
m= video 57787 RTP/AVP 93
a= rtpmap:93 MP4V-ES
a= label:bb
m= message 23456 TCP/MSRP *
a= accept-types:message/cpim application/vnd.oma.poc.final-report+xml

```

application/vnd.oma.poc.detailed-progress-report+xml
application/vnd.oma.poc.optimized-progress-report+xml

a=          accept-wrapped-types:text/plain

a=          path:msrp://[57777::eee:fff:aaa:bbb]:23456/12wzz1K92w5;tcp

a=          max-size:64000

```

A. TBCP Talk Burst Taken message (from PoC Server X to PoC Server A)

The PoC Server X sends a TBCP Talk Burst Taken message to the PoC Server A. TB Taken is sent only in the case that another PoC Client has permission to speak.

B. TBCP Talk Burst Taken message (from PoC Server A to PoC Client A)

The PoC Server A sends the TBCP Talk Burst Taken message to the PoC Client A.

C. RTP Media from PoC Server X to PoC Server A

The PoC Server X sends the RTP Media to the PoC Server A.

D. RTP Media from PoC Server A to PoC Client A

The PoC Server A sends the RTP Media to the PoC Client A.

16. SIP ACK request (PoC Client A to SIP/IP Core A)

The PoC Client A acknowledges the SIP 200 "OK" response with a SIP ACK request sent to the SIP/IP Core A.

17. SIP ACK request (SIP/IP Core A to PoC Server A)

The SIP/IP Core A forwards the SIP ACK request to the PoC Server A.

18. SIP ACK request (PoC Server A to SIP/IP Core A)

The PoC Server A forwards the SIP ACK request to the SIP/IP Core A.

19. SIP ACK request (SIP/IP Core A to SIP/IP Core X)

The SIP/IP Core A forwards the SIP ACK request to the SIP/IP Core X.

20. SIP ACK request (SIP/IP Core X to PoC Server X)

The SIP/IP Core X forwards the SIP ACK request to the PoC Server X.

F.7 Joining a Chat PoC Group Session

F.7.1 Using on-demand signaling

This subclause describes the successful joining to an ongoing Chat PoC Group PoC Session using On-demand signaling.

The PoC Media Traffic Optimisation is used between the PoC Server A and PoC Server X.

The QoE Profile assigned to the Chat PoC Group is the 'Premium' QoE Profile. The PoC Client A requests 'Official Government Use' as the Local QoE Profile.

NOTE: The signaling flow is valid for rejoining a Chat PoC Group Session.

Figure 13: "Joining a Chat PoC Group Session" shows the signaling flow for the scenario.

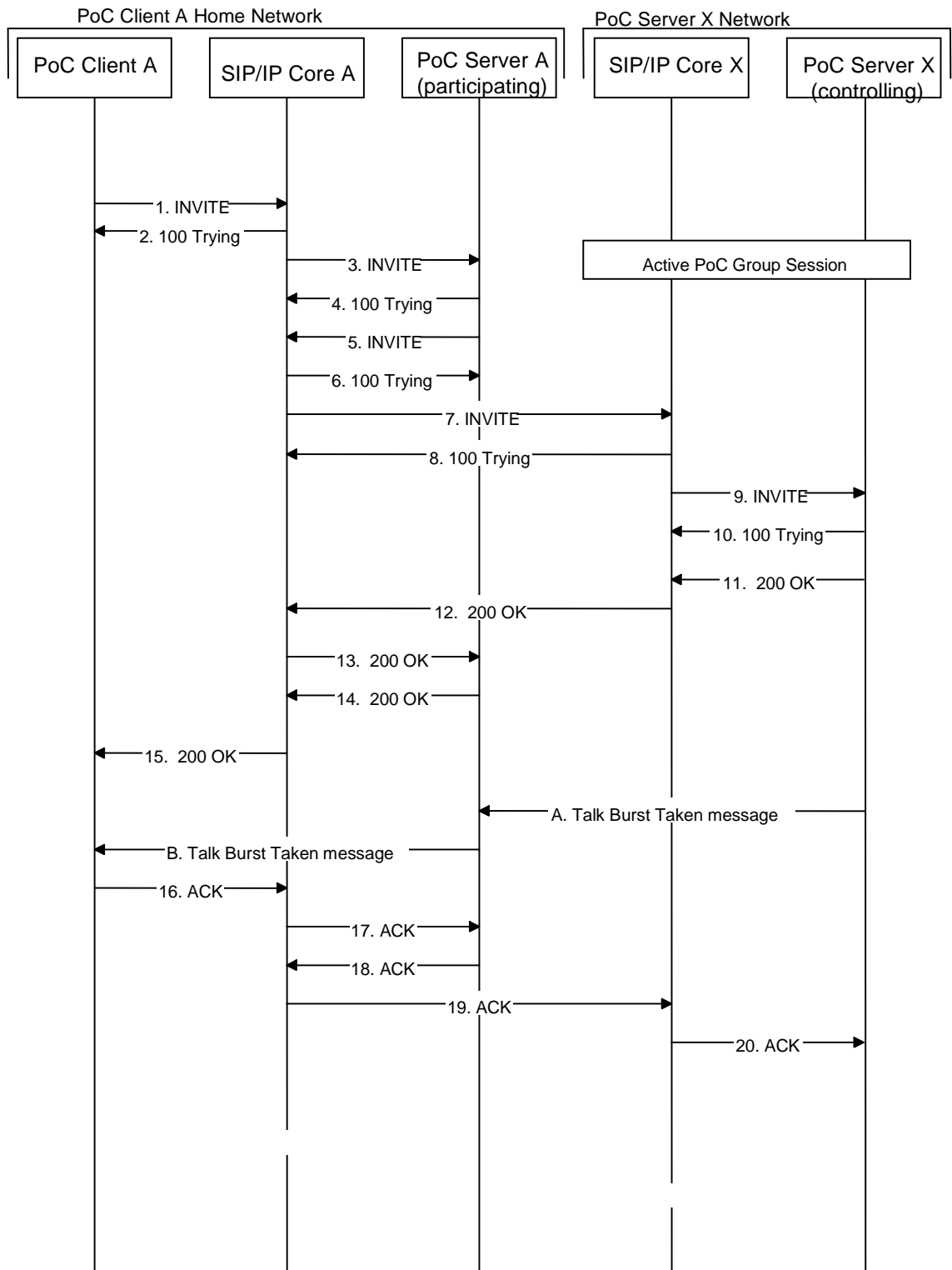

Figure 13: Joining a Chat PoC Group Session.

The steps of the flows are as follows:

1. SIP INVITE request (from PoC Client A to SIP/IP Core A)

The PoC Client receives a request from the PoC User to join a Chat Group PoC Session and sends a SIP INVITE request to the SIP/IP Core A. The SIP INVITE request includes the Chat PoC Group Identity in the Request-URI.

Request-URI sip:OMA-Golf-buddies@networkX.net;session=chat

SIP HEADERS

P-Preferred-Identity: "PoC User A" <sip:PoC-UserA@networkA.net>
Accept-Contact: *;+g.poc.talkburst; require;explicit
User-Agent: PoC-client/OMA2.0 Acme-Talk5000/v1.01
Privacy: id
Contact: <sip:PoC-ClientA.networkA.net>;+sip.instance="<urn:uuid:00000000-0000-1000-8000-000A95A0E128>";+g.poc.talkburst +g.poc.fdcfo; +g.poc.discretedia
Supported: timer
Session-Expires: 1800;refresher=uac
Allow: INVITE,ACK,CANCEL,BYE,REFER,MESSAGE,SUBSCRIBE, NOTIFY,PUBLISH,OPTIONS
Accept-Language en
Resource-Priority wps.2

SDP PARAMETERS

c= IN IP6 5555::aaa:bbb:ccc:ddd
a= poc-qoe:government-use
m= audio 3456 RTP/AVP 97
a= rtpmap:97 AMR
a= rtcp:5560
i= speech
b= AS:25.4
a= label:aa
m= application 2000 udp TBCP
a= fmp:TBCP queuing=1; tb_priority=2; timestamp=1; multimedia=1; mbc_scheme="random"; tb_txbw=64; poc_sess_priority=1;local_grant=1; imp_mb_req=0

```

a=          floorid:0 mstrm:aa bb
m=          video 3456 RTP/AVP 99
a=          rtpmap:99 MP4V-ES
b=          AS:75
a=          label:bb
m=          message 12345 TCP/MSRP *
a=          accept-types:message/cpim application/vnd.oma.poc.final-report+xml
            application/vnd.oma.poc.detailed-progress-report+xml
            application/vnd.oma.poc.optimized-progress-report+xml
a=          accept-wrapped-types:text/plain
a=          path:msrp://[5555::aaa:bbb:ccc:ddd]:12345/kjhd37s2s20w2a;tcp
a=          max-size:10000

```

2. SIP 100 "Trying" response (from SIP/IP Core A to PoC Client A)

The SIP/IP Core A sends a SIP 100 "Trying" response to the PoC Client A.

3. SIP INVITE request (from SIP/IP Core A to PoC Server A)

The SIP/IP Core A sends the SIP INVITE request to the PoC Server A.

Request-URI sip:OMA-Golf-buddies@networkX.net;session=chat

SIP HEADERS

P-Asserted-Identity: "PoC User A" <sip:PoC-UserA@networkA.net>

Accept-Contact: *,+g.poc.talkburst; require;explicit

User-Agent: PoC-client/OMA2.0 Acme-Talk5000/v1.01

Privacy: id

Contact: <sip:PoC-ClientA networkA.net>;+sip.instance="<urn:uuid:00000000-0000-1000-8000-000A95A0E128>";+g.poc.talkburst; +g.poc.fdcfo; +g.poc.discretemedia

Supported: timer

Session-Expires: 1800;refresher=uac

Allow: INVITE,ACK,CANCEL,BYE,REFER,MESSAGE,SUBSCRIBE, NOTIFY,PUBLISH,OPTIONS

Accept-Language en

Resource-Priority wps.2

SDP PARAMETERS

```

c=                IN IP6 5555::aaa:bbb:ccc:ddd
a=                poc-qoe:government-use
m=                audio 3456 RTP/AVP 97
a=                rtpmap:97 AMR
a=                rtcp:5560
i=                speech
b=                AS:25.4
a=                label:aa
m=                application 2000 udp TBCP
a=                fmt:TBCP queuing=1; tb_priority=2; timestamp=1; multimedia=1;
                 mbc_scheme="random"; tb_txbw=64; poc_sess_priority=1;local_grant=1;
                 imp_mb_req=0
a=                floorid:0 mstrm:aa bb
m=                video 3456 RTP/AVP 99
a=                rtpmap:99 MP4V-ES
b=                AS:75
a=                label:bb
m=                message 12345 TCP/MSRP *
a=                accept-types:message/cpim application/vnd.oma.poc.final-report+xml
                 application/vnd.oma.poc.detailed-progress-report+xml
                 application/vnd.oma.poc.optimized-progress-report+xml
a=                accept-wrapped-types:text/plain
a=                path:msrp://[5555::aaa:bbb:ccc:ddd]:12345/kjhd37s2s20w2a;tcp
a=                max-size:10000

```

4. SIP 100 "Trying" response (from PoC Server A to SIP/IP Core A)

The PoC Server A sends a SIP 100 "Trying" response to the SIP/IP Core A.

5. SIP INVITE request (from PoC Server A to SIP/IP Core A)

Using the PoC Group Identity the PoC Server A determines that the Chat PoC Group is owned by another PoC Server and sends the SIP INVITE request to the SIP/IP Core A. The SIP INVITE request includes the Chat PoC Group Identity in the Request-URI.

Request-URI sip:OMA-Golf-buddies@networkX.net;session=chat

SIP HEADERS

P-Asserted-Identity: "PoC User A" <sip:PoC-UserA@networkA.net>
Accept-Contact: *,+g.poc.talkburst; require;explicit
User-Agent: PoC-serv/OMA2.0
Privacy: id
Contact: <sip:PoC-SessionABCDEF@PoC-ServerA.networkA.net>;+g.poc.talkburst;
+g.poc.discretemedia;+g.poc.fdcfo; b2bua
Supported: timer
Session-Expires: 1800;refresher=uac
Allow: INVITE,ACK,CANCEL,BYE,REFER,MESSAGE,SUBSCRIBE,
NOTIFY,PUBLISH,OPTIONS
Accept-Language en
Resource-Priority wps.2

SDP PARAMETERS

c= IN IP6 50555::ccc:ddd:aaa:bbb
a= poc-qoe:government-use
m= audio 53456 RTP/AVP 97 98
a= rtpmap:97 AMR
a= rtpmap:98 EVRC/8000
a= rtcp:53080
i= speech
b= AS:25.4
a= label:aa
a= upcc:0
a= sendonly
m= Application 50000 udp TBCP
a= fmp: TBCP queuing=1; tb_priority=2; timestamp=1; multimedia=1;
mbc_scheme="random"; tb_txbw=64; poc_sess_priority=1;local_grant=1;
imp_mb_req=0
a= floorid:0 mstrm:aa bb
m= video 53456 RTP/AVP 99
a= rtpmap:99 MP4V-ES

b= AS:75
a= label:bb
a= upcc:0
a= sendonly
m= message 54321 TCP/MSRP *
a= accept-types:message/cpim application/vnd.oma.poc.final-report+xml
 application/vnd.oma.poc.detailed-progress-report+xml
 application/vnd.oma.poc.optimized-progress-report+xml
a= accept-wrapped-types:text/plain
a= path:msrp://[50555::ccc:ddd:aaa:bbb]:54321/kjhd37p4z789w1;tcp
a= max-size:10000

6. SIP 100 "Trying" response (from SIP/IP Core A to PoC Server A)

The SIP/IP Core A sends a SIP 100 "Trying" response to the PoC Server A.

7. SIP INVITE request (from SIP/IP Core A to SIP/IP Core X)

Based on the Chat PoC Group Identity in the Request-URI the SIP/IP Core A sends the SIP INVITE request to the SIP/IP Core X.

Request-URI sip:OMA-Golf-buddies@networkX.net;session=chat

SIP HEADERS

P-Asserted-Identity: "PoC User A" <sip:PoC-UserA@networkA.net>
Accept-Contact: *,+g.poc.talkburst; require;explicit
User-Agent: PoC-serv/OMA2.0
Privacy: id
Contact: <sip:PoC-SessionABCDEF@PoC-ServerA.networkA.net>;+g.poc.talkburst;
 +g.poc.fdcfo;+g.poc.discretedia; b2bua
Supported: timer
Session-Expires: 1800;refresher=uac
Allow: INVITE,ACK,CANCEL,BYE,REFER,MESSAGE,SUBSCRIBE,
 NOTIFY,PUBLISH,OPTIONS
Accept-Language en
Resource-Priority wps.2

SDP PARAMETERS

```

c=          IN IP6 50555::ccc:ddd:aaa:bbb
a=          poc-qoe:government-use
m=          audio 53456 RTP/AVP 97 98
a=          rtpmap:97 AMR
a=          rtpmap:98 EVRC/8000
a=          rtcp:53080
i=          speech
b=          AS:25.4
a=          label:aa
a=          upcc:0
a=          sendonly
m=          Application 50000 udp TBCP
a=          fmp: TBCP queuing=1; tb_priority=2; timestamp=1;multimedia=1;
            mbc_scheme="random"; tb_txbw=64; poc_sess_priority=1;local_grant=1;
            imp_mb_req=0
a=          floorid:0 mstrm:aa bb
m=          video 53456 RTP/AVP 99
a=          rtpmap:99 MP4V-ES
b=          AS:75
a=          label:bb
a=          upcc:0
a=          sendonly
m=          message 54321 TCP/MSRP *
a=          accept-types:message/cpim application/vnd.oma.poc.final-report+xml
            application/vnd.oma.poc.detailed-progress-report+xml
            application/vnd.oma.poc.optimized-progress-report+xml
a=          accept-wrapped-types:text/plain
a=          path:msrp://[50555::ccc:ddd:aaa:bbb]:54321/kjhd37p4z789w1;tcp
a=          max-size:10000

```

8. SIP 100 "Trying" response (from SIP/IP Core X to SIP/IP Core A)

The SIP/IP Core X sends a SIP 100 "Trying" response to the SIP/IP Core A.

9. SIP INVITE request (from SIP/IP Core X to PoC Server X)

The SIP/IP Core X sends the SIP INVITE request to the PoC Server X.

Request-URI sip:OMA-Golf-buddies@networkX.net;session=chat

SIP HEADERS

P-Asserted-Identity: "PoC User A" <sip:PoC-UserA@networkA.net>
Accept-Contact: *,+g.poc.talkburst; require;explicit
User-Agent: PoC-serv/OMA2.0
Privacy: id
Contact: <sip:PoC-SessionABCDEF@PoC-ServerA.networkA.net>;+g.poc.talkburst;
+g.poc.fdcfo;+g.poc.discretemedia; b2bua
Supported: timer
Session-Expires: 1800;refresher=uac
Allow: INVITE,ACK,CANCEL,BYE,REFER,MESSAGE,SUBSCRIBE,
NOTIFY,PUBLISH,OPTIONS
Accept-Language en
Resource-Priority wps.2

SDP PARAMETERS

c= IN IP6 50555::ccc:ddd:aaa:bbb
a= poc-qoe:government-use
m= audio 53456 RTP/AVP 97 98
a= rtpmap:97 AMR
a= rtpmap:98 EVRC/8000
a= rtcp:53080
i= speech
b= AS:25.4
a= label:aa
a= sendonly
a= upcc:0
m= Application 50000 udp TBCP
a= fmp: TBCP queuing=1; tb_priority=2; timestamp=1; multimedia=1;
mbc_scheme="random"; tb_txbw=64; poc_sess_priority=1;local_grant=1;
imp_mb_req=0

```

a=          floorid:0 mstrm:aa bb
m=          video 53456 RTP/AVP 99
a=          rtpmap:99 MP4V-ES
b=          AS:75
a=          label:bb
a=          upcc:0
a=          sendonly
m=          message 54321 TCP/MSRP *
a=          accept-types:message/cpim application/vnd.oma.poc.final-report+xml
            application/vnd.oma.poc.detailed-progress-report+xml
            application/vnd.oma.poc.optimized-progress-report+xml
a=          accept-wrapped-types:text/plain
a=          path:msrp://[50555::ccc:ddd:aaa:bbb]:54321/kjhd37p4z789w1;tcp
a=          max-size:10000

```

10. SIP 100 "Trying" response (from PoC Server X to SIP/IP Core X)

The PoC Server X sends the SIP 100 "Trying" response to the SIP/IP Core X.

11. SIP 200 "OK" response (from PoC Server X to SIP/IP Core X)

The PoC Server X authorizes the PoC Client A to rejoin to the Chat PoC Group Session and sends the SIP 200 "OK" response to the SIP/IP Core X.

SIP HEADERS

```

P-Asserted-Identity: <sip:OMA-Golf-buddies@networkX.net;session=chat>
Contact               <sip:PoC-SessionABCDEF@PoC-
                        ServerX.networkX.net;session=chat>;+g.poc.talkburst;isfocus
Server:              PoC-serv/OMA2.0
Require:             timer
Session-Expires:    1800;refresher=uac
Allow:               INVITE,ACK,CANCEL,BYE,PRACK, UPDATE,
                        REFER,MESSAGE,SUBSCRIBE, NOTIFY,PUBLISH,OPTIONS
Supported:          norefersub

```

SDP PARAMETERS

```

c=          IN IP6 9666::eee: aaa:bbb:fff
a=          poc-qoe:premium

```

```

m=          audio 9652 RTP/AVP 98
a=          rtpmap:98 EVRC/8000
a=          rtcp:9600
a=          upcc:0
a=          recvonly
i=          speech
a=          label:aa
m=          application 9600 udp TBCP
a=          fntp:TBCP queuing=1; tb_priority=2; timestamp=1; multimedia=1;
           mbc_scheme="random"; tb_txbw=64; poc_sess_priority=1;local_grant=1;
           imp_mb_req=0
a=          floorid:0 mstrm:aa bb
m=          video 9652 RTP/AVP 93
a=          rtpmap:93 MP4V-ES
a=          label:bb
a=          upcc:0
a=          recvonly
m=          message 18912 TCP/MSRP *
a=          accept-types:message/cpim application/vnd.oma.poc.final-report+xml
           application/vnd.oma.poc.detailed-progress-report+xml
           application/vnd.oma.poc.optimized-progress-report+xml
a=          accept-wrapped-types:text/plain
a=          path:msrp://[9666:: eee:aaa:bbb:fff]:18912/zrtopxW45;tcp
a=          max-size:64000

```

12. SIP 200 "OK" response (from SIP/IP Core X to SIP/IP Core A)

The SIP/IP Core X sends the SIP 200 "OK" response to the SIP/IP Core A.

SIP HEADERS

```

P-Asserted-Identity: <sip:OMA-Golf-buddies@networkX.net;session=chat>
Contact              <sip:PoC-SessionABCDEF@PoC-
                       ServerX.networkX.net;session=chat>;+g.poc.talkburst;isfocus
Server:             PoC-serv/OMA2.0
Require:            timer
Session-Expires:   1800;refresher=uac

```

Allow: INVITE,ACK,CANCEL,BYE,PRACK, UPDATE,
REFER,MESSAGE,SUBSCRIBE, NOTIFY,PUBLISH,OPTIONS

Supported: norefersub

SDP PARAMETERS

c= IN IP6 9666::eee: aaa:bbb:fff

a= poc-qoe:premium

m= audio 9652 RTP/AVP 98

a= rtpmap:98 EVRC/8000

a= rtcp:9600

a= upcc:0

i= speech

a= recvonly

a= label:aa

m= application 9600 udp TBCP

a= fmp: TBCP queuing=1; tb_priority=2; timestamp=1; multimedia=1;
mbc_scheme="random"; tb_txbw=64; poc_sess_priority=1; local_grant=1;
imp_mb_req=0

a= floorid:0 mstrm:aa bb

m= video 9652 RTP/AVP 93

a= rtpmap:93 MP4V-ES

b= AS:75

a= label:bb

a= upcc:0

a= recvonly

m= message 18912 TCP/MSRP *

a= accept-types:message/cpim application/vnd.oma.poc.final-report+xml
application/vnd.oma.poc.detailed-progress-report+xml
application/vnd.oma.poc.optimized-progress-report+xml

a= accept-wrapped-types:text/plain

a= path:msrp://[9666:: eee:aaa:bbb:fff]:18912/zrtopxW45;tcp

a= max-size:64000

13. SIP 200 "OK" response (from SIP/IP Core A to PoC Server A)

The SIP/IP Core A sends the SIP 200 "OK" response to the PoC Server A.

SIP HEADERS

P-Asserted-Identity: <sip:OMA-Golf-buddies@networkX.net;session=chat>
Contact <sip:PoC-SessionABCDEF@PoC-ServerX.networkX.net;session=chat>;+g.poc.talkburst;isfocus
Server: PoC-serv/OMA2.0
Require: timer
Session-Expires: 1800;refresher=uac
Allow: INVITE,ACK,CANCEL,BYE,PRACK, UPDATE, REFER,MESSAGE,SUBSCRIBE, NOTIFY,PUBLISH,OPTIONS
Supported: norefersub

SDP PARAMETERS

c= IN IP6 9666::eee: aaa:bbb:fff
a= poc-qoe:premium
m= audio 96525 RTP/AVP 98
a= rtpmap:98 EVRC/8000
a= rtcp:9600
a= upcc:0
i= speech
a= label:aa
a= recvonly
m= application 9600 udp TBCP
a= fmp: TBCP queuing=1; tb_priority=2; timestamp=1; multimedia=1; mbc_scheme="random"; tb_txbw=64; poc_sess_priority=1; local_grant=1; imp_mb_req=0
a= floorid:0 mstrm:aa bb
m= video 9652 RTP/AVP 93
a= rtpmap:93 MP4V-ES
a= label:bb
a= upcc:0
a= recvonly
m= message 18912 TCP/MSRP *

a= accept-types:message/cpim application/vnd.oma.poc.final-report+xml
 application/vnd.oma.poc.detailed-progress-report+xml
 application/vnd.oma.poc.optimized-progress-report+xml

a= accept-wrapped-types:text/plain

a= path:msrp://[9666::eee:aaa:bbb:fff]:18912/zrtopxW45;tcp

a= max-size:64000

14. SIP 200 "OK" response (from PoC Server A to SIP/IP Core A)

The PoC Server A sends the SIP 200 "OK" response to SIP/IP Core A.

SIP HEADERS

P-Asserted-Identity: <sip:OMA-Golf-buddies@networkX.net;session=chat>

Contact <sip:PoC-SessionABCDEF@ PoC-ServerA.networkA.net
 ;session=chat>;+g.poc.talkburst;isFocus

Server: PoC-serv/OMA2.0

Require: timer

Session-Expires: 1800;refresher=uac

Allow: INVITE,ACK,CANCEL,BYE,PRACK, UPDATE,
 REFER,MESSAGE,SUBSCRIBE, NOTIFY,PUBLISH,OPTIONS

Supported: norefersub

SDP PARAMETERS

c= IN IP6 57777::eee:fff:aaa:bbb

a= poc-qoe:premium

m= audio 57787 RTP/AVP 98

a= rtpmap:98 EVRC/8000

a= rtcp:57000

a= upcc:0

i= speech

a= label:aa

m= application 57790 udp TBCP

a= fmp: TBCP queuing=1; tb_priority=2; timestamp=1; multimedia=1;
 mbc_scheme="random"; tb_txbw=64; poc_sess_priority=1;local_grant=1;
 imp_mb_req=0

a= floorid:0 mstrm:aa bb

```

m=          video 57787 RTP/AVP 93
a=          rtpmap:93 MP4V-ES
a=          label:bb
m=          message 23456 TCP/MSRP *
a=          accept-types:message/cpim application/vnd.oma.poc.final-report+xml
            application/vnd.oma.poc.detailed-progress-report+xml
            application/vnd.oma.poc.optimized-progress-report+xml
a=          accept-wrapped-types:text/plain
a=          path:msrp://[ 57777::eee:fff:aaa:bbb]:23456/l2wzz1K92w5;tcp
a=          max-size:64000

```

15. SIP 200 "OK" response (from SIP/IP Core A to PoC Client A)

The SIP/IP Core A sends the SIP 200 "OK" response to the PoC Client A.

SIP HEADERS

```

P-Asserted-Identity: <sip:OMA-Golf-buddies@networkX.net;session=chat>
Contact               <sip:PoC-SessionABCDEF@PoC-ServerA.networkA.net
                        ;session=chat>;+g.poc.talkburst;isFocus
Server:              PoC-serv/OMA2.0
Require:             timer
Session-Expires:    1800;refresher=uac
Allow:               INVITE,ACK,CANCEL,BYE,PRACK, UPDATE,
                        REFER,MESSAGE,SUBSCRIBE, NOTIFY,PUBLISH,OPTIONS
Supported:          norefersub

```

SDP PARAMETERS

```

c=          IN IP6 57777::eee:fff:aaa:bbb
a=          poc-qoe:premium
m=          audio 57787 RTP/AVP 98
a=          rtpmap:98 EVRC/8000
a=          rtcp:57000
a=          upcc:0
i=          speech
a=          label:aa

```

```

m=          application 57790 udp TBCP
a=          fmp: TBCP queuing=1; tb_priority=2; timestamp=1; multimedia=1;
           mbc_scheme="random"; tb_txbw=64; poc_sess_priority=1; local_grant=1;
           imp_mb_req=0
a=          floorid:0 mstrm:aa bb
m=          video 57787 RTP/AVP 93
a=          rtpmap:93 MP4V-ES
a=          label:bb
m=          message 23456 TCP/MSRP *
a=          accept-types:message/cpim application/vnd.oma.poc.final-report+xml
           application/vnd.oma.poc.detailed-progress-report+xml
           application/vnd.oma.poc.optimized-progress-report+xml
a=          accept-wrapped-types:text/plain
a=          path:msrp://[ 57777::eee:fff:aaa:bbb]:23456/12wzz1K92w5;tcp
a=          max-size:64000

```

A. TBCP Talk Burst Taken message (from PoC Server X to PoC Server A)

The PoC Server X sends a TBCP Talk Burst Taken message to the PoC Server A.

B. TBCP Talk Burst Taken message (from PoC Server A to PoC Client A)

The PoC Server A sends the TBCP Talk Burst Taken message to the PoC Client A.

16. SIP ACK request (PoC Client A to SIP/IP Core A)

The PoC Client A acknowledges the SIP 200 "OK" response with a SIP ACK request sent to the SIP/IP Core A.

17. SIP ACK request (SIP/IP Core A to PoC Server A)

The SIP/IP Core A forwards the SIP ACK request to the PoC Server A.

18. SIP ACK request (PoC Server A to SIP/IP Core A)

PoC Server A forwards the SIP ACK request to SIP/IP Core A.

19. SIP ACK request (SIP/IP Core A to SIP/IP Core X)

The SIP/IP Core A forwards the SIP ACK request to the SIP/IP Core X.

20. SIP ACK request (SIP/IP Core X to PoC Server X)

The SIP/IP Core X forwards the SIP ACK request to the PoC Server X.

F.8 Canceling a PoC Session initialization

This subclause describes the message flow when a PoC Client A initiates a PoC Session and before the PoC Session is established the PoC Client cancels the PoC Session establishment.

F.8.1 Originating flow

This subclause shows the procedures for cancelling the PoC Session establishment on the originating side for the On-demand case when the PoC Server performing the Participating PoC Function acts as a B2BUA.

Figure 14 "Cancelling a PoC Session establishment, originating flow" shows the message flow for the scenario.

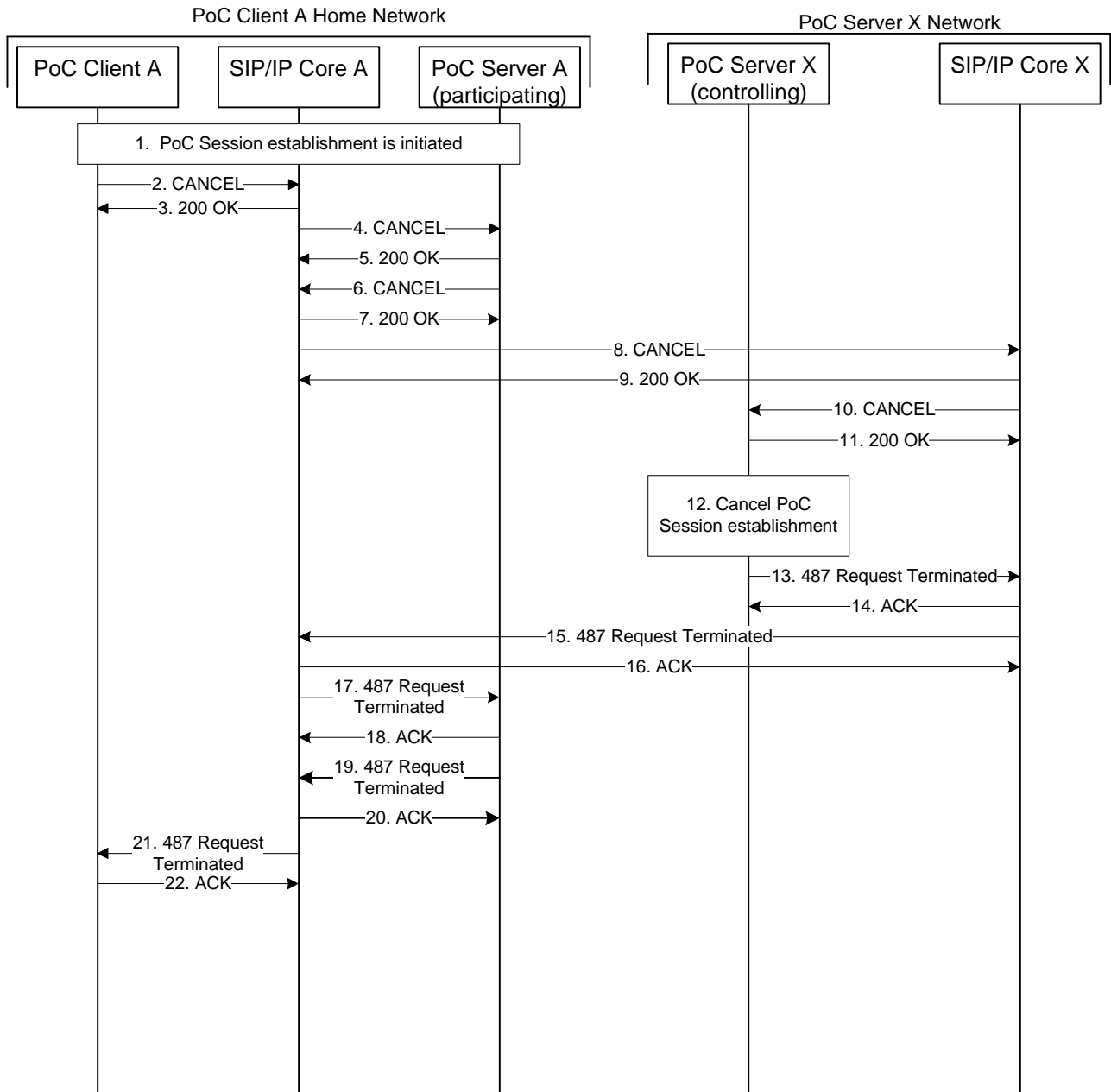

Figure 14: Cancelling a PoC Session establishment, originating flow

The steps of the flows are as follows:

1. PoC Session establishment is initiated.

The PoC Client A initiates the establishment of a PoC Session, e.g. a Pre-arranged PoC Group Session On-demand case.

2. SIP CANCEL request (from the PoC Client A to SIP/IP Core A).

The PoC Client A cancels the establishment of the PoC Session, e.g. because of a PoC User interaction and sends a SIP CANCEL request to the SIP/IP Core A.

Request-URI Sip:My-Golf-buddies@networkX.net

3. SIP 200 "OK" response (from SIP/IP Core A to the PoC Client A)

The SIP/IP Core A sends the SIP 200 "OK" response to the PoC Client A.

4. SIP CANCEL request (from SIP/IP Core A to the PoC Server A)

The SIP/IP Core A sends the SIP CANCEL request to the PoC Server A.

Request-URI Sip:My-Golf-buddies@networkX.net

5. SIP 200 "OK" response (from the PoC Server A to SIP/IP Core A)

The PoC Server A sends the SIP 200 "OK" response to the SIP/IP Core A.

6. SIP CANCEL request (from the PoC Server A to SIP/IP Core A)

The PoC Server A sends the SIP CANCEL request to SIP/IP Core A.

Request-URI Sip:My-Golf-buddies@networkX.net

7. SIP 200 "OK" response (from SIP/IP Core A to the PoC Server A)

The SIP/IP Core A sends the SIP 200 "OK" response to the PoC Server A.

8. SIP CANCEL request (from SIP/IP Core A to SIP/IP Core X)

The SIP/IP Core A sends the SIP CANCEL request to the SIP/IP Core X.

Request-URI Sip:My-Golf-buddies@networkX.net

9. SIP 200 "OK" response (from SIP/IP Core X to SIP/IP Core A)

The SIP/IP Core X sends the SIP 200 "OK" response to SIP/IP Core A.

10. SIP CANCEL request (from SIP/IP Core X to the PoC Server X)

The SIP/IP Core X sends the SIP CANCEL request to the PoC Server X.

Request-URI Sip:My-Golf-buddies@networkX.net

11. SIP 200 "OK" response (from the PoC Server X to SIP/IP Core X)

The PoC Server X sends the SIP 200 "OK" response to SIP/IP Core X.

12. Cancel PoC Session initialization

The PoC Server X cancels the invitation to the PoC Session for each Invited PoC Users as shown in Figure 15 "*Canceling a PoC Session establishment, terminating flow*".

13. SIP 487 "Request Terminated" response (from the PoC Server X to SIP/IP Core X)

The PoC Server X sends the SIP 487 "Request Terminated" response to the SIP/IP Core X to indicate that the SIP session establishment is terminated.

14. SIP ACK request (from the SIP/IP Core X to the PoC Server X)

The SIP/IP Core X sends the SIP ACK request to the PoC Server X.

15. SIP 487 "Request Terminated" response (from the SIP/IP Core X to the SIP/IP Core A)

The SIP/IP Core X sends the SIP 487 "Request Terminated" response to the SIP/IP Core A.

16. SIP ACK request (from the SIP/IP Core A to the SIP/IP Core X)

The SIP/IP Core A sends the SIP ACK request to the SIP/IP Core X.

17. SIP 487 "Request Terminated" response (from the SIP/IP Core A to the PoC Server A)

The SIP/IP Core A sends the SIP 487 "Request Terminated" response to the PoC Server A.

18. SIP ACK request (from the PoC Server A to the SIP/IP Core A)

The PoC Server A sends the SIP ACK request to the SIP/IP Core A.

19. SIP 487 "Request Terminated" response (from the PoC Server A to the SIP/IP Core A)

The PoC Server A sends the SIP 487 "Request Terminated" response to the SIP/IP Core A.

20. SIP ACK request (from the SIP/IP Core A to the PoC Server A)

The SIP/IP Core A sends the SIP ACK request to the PoC Server A.

21. SIP 487 "Request Terminated" response (from the SIP/IP Core A to the PoC Client A)

The SIP/IP Core A sends the SIP 487 "Request Terminated" response to the PoC Client A.

22. SIP ACK request (from the PoC Client A to the SIP/IP Core A)

The PoC Client A sends the SIP ACK request to the SIP/IP Core A.

F.8.2 Terminating flow

This subclause shows the procedure for cancelling an invitation to a PoC Session for the On-demand Session case and when the PoC Server performing the Participating PoC Function acts as a B2BUA.

In the case more than one PoC User was invited the procedure is repeated for each Invited PoC User.

Figure 15 "*Canceling a PoC Session establishment, terminating flow*" shows the signalling flow for the scenario.

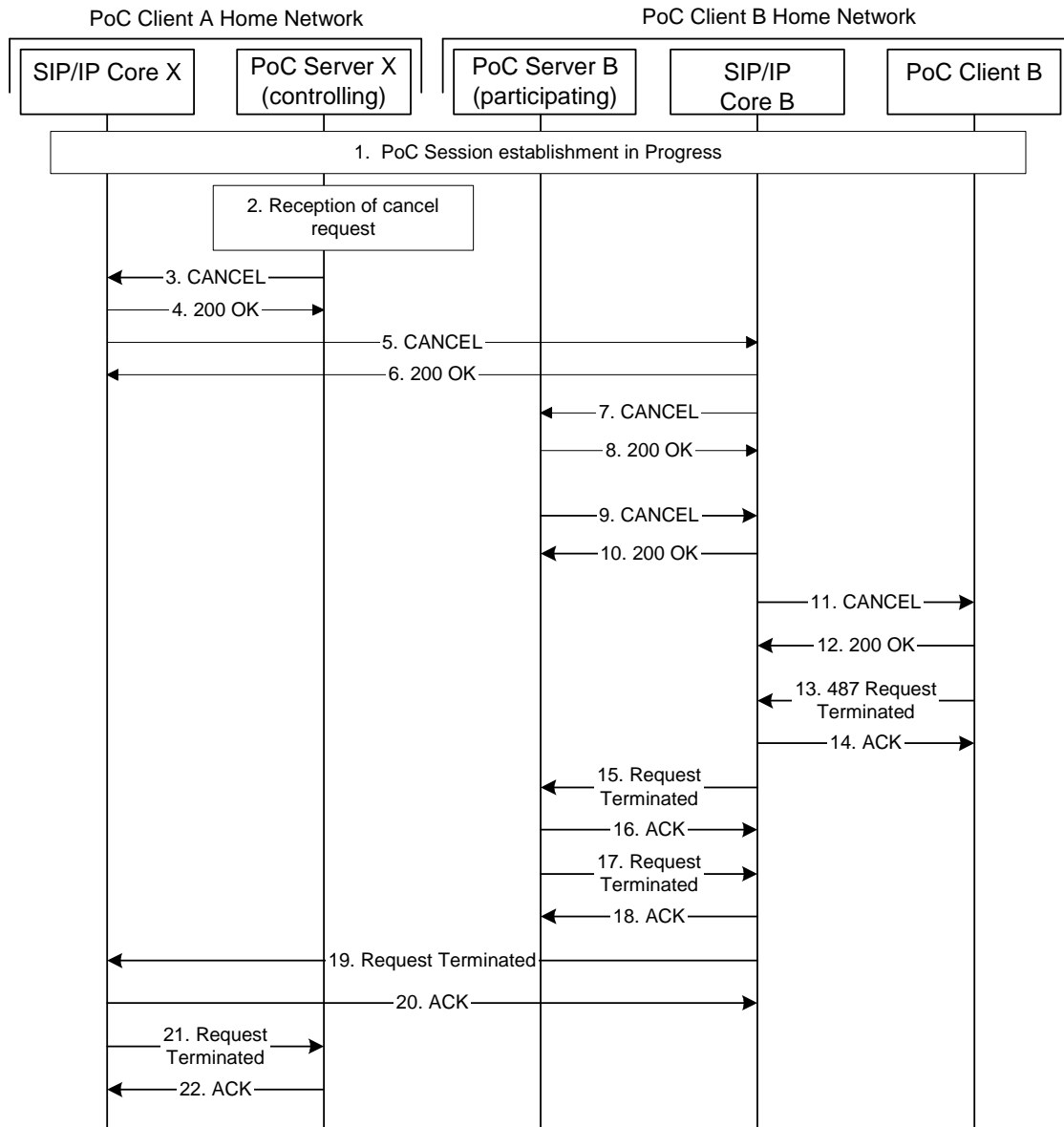

Figure 15: Cancelling a PoC Session establishment, terminating flow

The steps of the flows are as follows:

1. PoC Session establishment in Progress.

2. Reception of a cancel request

The PoC Server X (controlling) receives a request to cancel all invitations to the PoC Session. Figure 14 "Cancelling a PoC Session establishment, originating flow" shows the signalling flow for the originating procedure.

3. SIP CANCEL request (from the PoC Server X to SIP/IP Core X)

4. SIP 200 "OK" response (from SIP/IP Core X to the PoC Server X)
5. SIP CANCEL request (from SIP/IP Core X to SIP/IP Core B)
6. SIP 200 "OK" response (from SIP/IP Core B to SIP/IP Core X)
7. SIP CANCEL request (from SIP/IP Core B to the PoC Server B)
8. SIP 200 "OK" response (from the PoC Server B to SIP/IP Core B)
9. SIP CANCEL request (from the PoC Server B to SIP/IP Core B)
10. SIP 200 "OK" response (from SIP/IP Core B to the PoC Server B)
11. SIP CANCEL request (from SIP/IP Core B to the PoC Client B)
12. SIP 200 "OK" response (from PoC Client B to SIP/IP Core B)
13. SIP 487 "Request Terminated" response (from the PoC Client B to SIP/IP Core B)
14. SIP ACK request (from SIP/IP Core B to the PoC Client B)
15. SIP 487 "Request Terminated" response (from SIP/IP Core B to the PoC Server B)
16. SIP ACK request (from the PoC Server B to SIP/IP Core B)
17. SIP 487 "Request Terminated" response (from PoC Server B to SIP/IP Core B)
18. SIP ACK request (from the SIP/IP Core B to the PoC Server B)
19. SIP 487 "Request Terminated" response (from SIP/IP Core B to SIP/IP Core X)

20. SIP ACK request (from SIP/IP Core X to SIP/IP Core X)

21. SIP 487 "Request Terminated" response (from SIP/IP Core X to the PoC Server X)

22. SIP ACK request (from the PoC Server X to SIP/IP Core X)

F.9 Leaving/Disconnecting from a PoC Session

This subclause describes the scenario when a PoC Client leaves a PoC Session.

F.9.1 Originating flow – On-demand Session case

This subclause shows the procedures for leaving PoC Session establishment on the originating side for the On-demand case when the PoC Server performing the Participating PoC Function acts as a B2BUA.

Figure 16 "Leaving a PoC Session, originating flow – On-demand Session case" shows the message flow for the scenario.

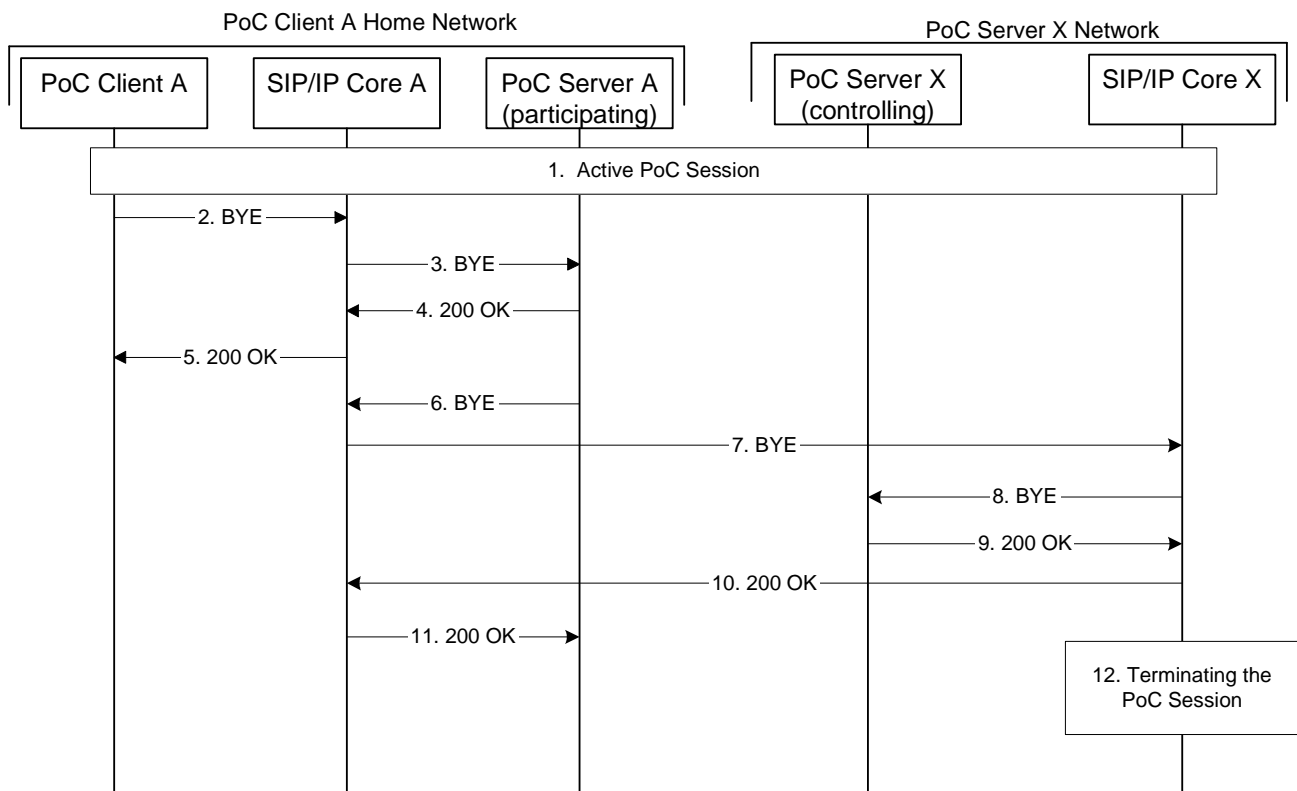

Figure 16: Leaving a PoC Session establishment, originating flow – On-demand Session case

The steps of the flows are as follows:

1. On-going PoC Session

An on-going PoC Session exists and two or more PoC Participants is connected.

2. SIP BYE request (from the PoC Client A to the SIP/IP Core A)

The PoC Client initiates release of the SIP session by sending the SIP BYE request to the SIP/IP Core A.

Request-URI sip:TokenA%PoC-Session-Identity1@PoC-ServerX.networkX.net%PoC-ServerA.networkA.net

SIP HEADERS

Privacy: id

3. SIP BYE request (from the SIP/IP Core A to the PoC Server A)

The SIP/IP Core A sends the SIP BYE request to the PoC Server A.

Request-URI sip:TokenA%PoC-Session-Identity1@PoC-ServerX.networkX.net%PoC-ServerA.networkA.net

SIP HEADERS

Privacy: id

4. SIP 200 "OK" response (from the PoC Server A to the SIP/IP Core A)

The PoC Server A sends the SIP 200 "OK" response to the SIP/IP Core A.

5. SIP 200 "OK" response (from the SIP/IP Core A to the PoC Client A)

The SIP/IP Core A sends the SIP 200 "OK" response to the PoC Client A.

6. SIP BYE request (from the PoC Server A to the SIP/IP Core A)

The PoC Server A sends the SIP BYE request to the SIP/IP Core A.

Request-URI sip: PoC-Session-Identity1@PoC-ServerX.networkX.net

SIP HEADERS

Privacy: id

7. SIP BYE request (from the SIP/IP Core A to the SIP/IP Core X)

The PoC Server A sends the SIP BYE request to SIP/IP Core A.

Request-URI sip: PoC-Session-Identity1@PoC-ServerX.networkX.net

SIP HEADERS

Privacy: id

8. SIP BYE request (from the SIP/IP Core X to the PoC Server X)

The SIP/IP Core X sends the SIP BYE request to the PoC Server X.

Request-URI sip: PoC-Session-Identity1@PoC-ServerX.networkX.net

SIP HEADERS

Privacy: id

9. SIP 200 "OK" response (from the PoC Server X to the SIP/IP Core X)

The PoC Server X sends the SIP 200 "OK" response to the SIP/IP Core X.

10. SIP 200 "OK" response (from the SIP/IP Core X to the SIP/IP Core A)

The SIP/IP Core X sends the SIP 200 "OK" response to the SIP/IP Core A.

11. SIP 200 "OK" response (from the SIP/IP Core A to the PoC Server A)

The SIP/IP Core A sends the SIP 200 "OK" response to the PoC Server A.

12. Terminating the PoC Session

Depending on the PoC Session release policy the PoC Server X disconnects all PoC Participants from the PoC Session as shown in Figure 18 "*Disconnecting a PoC Participant from a PoC Session, terminating flow – On-demand Session case*" or Figure 19 "*Disconnecting a PoC Participant from a PoC Session, terminating flow – Pre-established Session case*".

F.9.2 Originating flow – Pre-established Session case

This subclause shows the procedures for leaving PoC Session establishment on the originating side for the Pre-established case.

Figure 17 "*Leaving a PoC Session, originating flow – Pre-established Session case*" shows the message flow for the scenario.

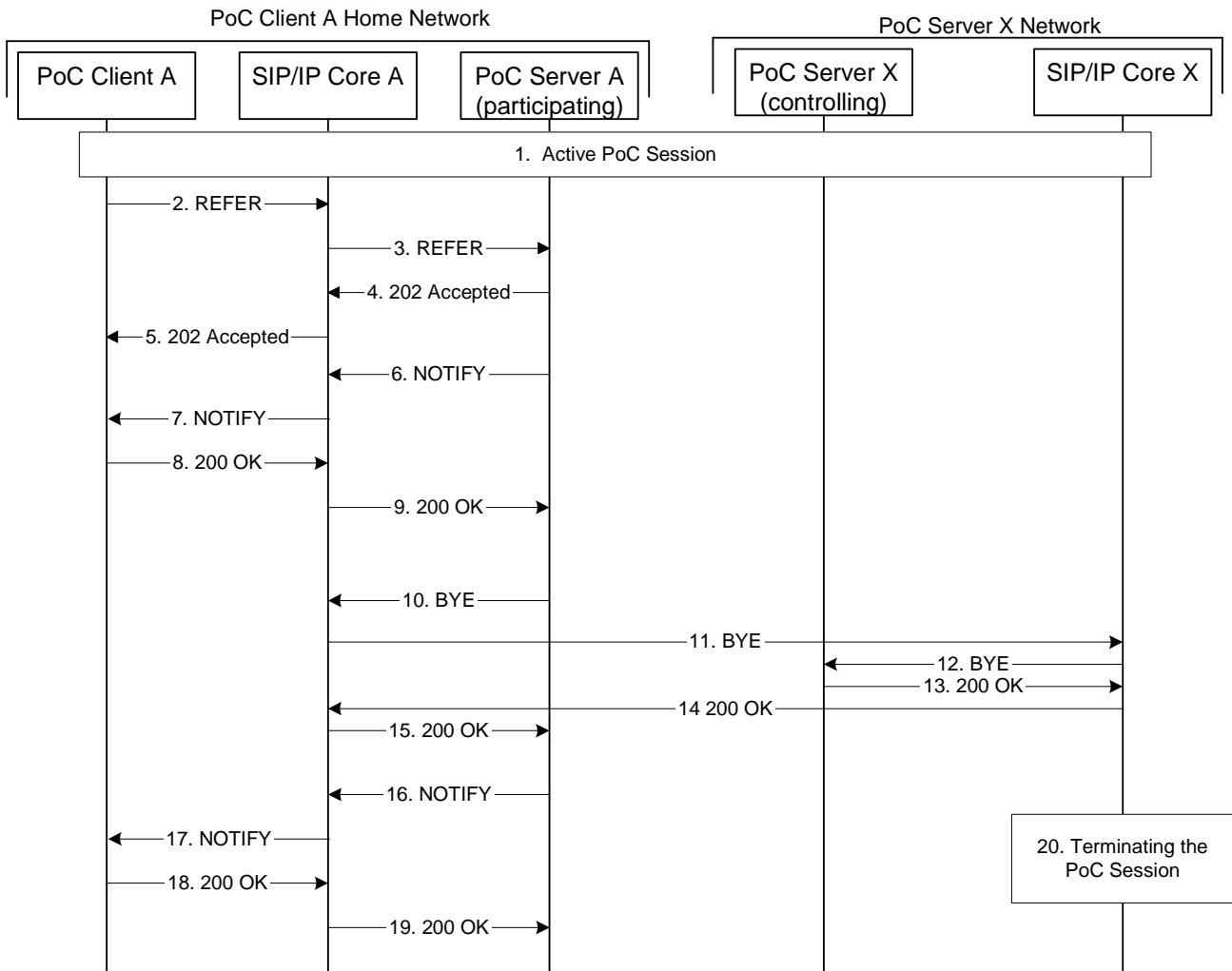

Figure 17: Leaving a PoC Session establishment, originating flow – Pre-established Session case

The steps of the flows are as follows:

1. On-going PoC Session

An on-going PoC Session exists and two or more PoC Participants is connected.

2. SIP REFER request (from the PoC Client A to SIP/IP Core A)

The PoC Client A sends a REFER request to the SIP/IP Core A.

Request-URI sip:Pre-establishedSessionIdentityA@PoC-ServerA.networkA.net

SIP HEADERS

Refer-To: sip:PoC-Session-Identity1@PoC-ServerX.networkX.net;method=BYE

Privacy: id

Contact sip:PoC-ClientA@

3. SIP REFER request (from SIP/IP Core A to the PoC Server A)

The SIP/IP Core A sends the REFER request to the PoC Server A.

Request-URI sip:Pre-establishedSessionIdentityA@PoC-ServerA.networkA.net

SIP HEADERS

Refer-To: sip:PoC-Session-Identity1@PoC-ServerX.networkX.net;method=BYE

Privacy: id

Contact sip:PoC-ClientA@

4. SIP 202 "Accepted" response (from the PoC Server A to SIP/IP Core A)

The PoC Server A sends a SIP 202 "Accepted" response to the SIP/IP Core A.

5. SIP 202 "Accepted" response (from SIP/IP Core A to the PoC Client A)

The SIP/IP Core A sends the SIP 202 "Accepted" response to the PoC Client A.

6. SIP NOTIFY request (from the PoC Server A to SIP/IP Core A)

The PoC Server sends a SIP NOTIFY request towards the PoC Client A and at the same time a SIP BYE request (see step 10) towards the PoC Server performing the Controlling PoC Function.

Request-URI sip:PoCClientA@networkA.net

SIP HEADERS

Subscription-State active

Content-Type message/sipfrag;version=2.0

MIME BODY

SIP/2.0 100 Trying

7. SIP NOTIFY request (from SIP/IP Core A to the PoC Client A)

The SIP/IP Core A sends the NOTIFY request to the PoC Client A.

Request-URI sip:PoCClientA@networkA.net

SIP HEADERS

Subscription-State active
Content-Type message/sipfrag;version=2.0

MIME BODY

SIP/2.0 100 Trying

8. SIP 200 "OK" response (from the PoC Client A to SIP/IP Core A)

The PoC Client A sends the SIP 200 "OK" response to the SIP/IP Core A.

9. SIP 200 "OK" response (from SIP/IP Core A to the PoC Server A)

The SIP/IP Core A sends the SIP 200 "OK" response to the PoC Server A.

10. SIP BYE request (from the PoC Server A to SIP/IP Core A)

The PoC Server A sends a SIP BYE request to the SIP/IP Core A.

Request-URI sip:PoC-Session-Identity1@PoC-ServerX.networkX.net

11. SIP BYE request (from SIP/IP Core A to SIP/IP Core X)

The SIP/IP Core A sends the SIP BYE request to the SIP/IP Core X.

Request-URI sip:PoC-Session-Identity1@PoC-ServerX.networkX.net

12. SIP BYE request (from SIP/IP Core X to the PoC Server X)

The SIP/IP Core X sends the SIP BYE request to the PoC Server X.

Request-URI sip:PoC-Session-Identity1@PoC-ServerX.networkX.net

13. SIP 200 "OK" response (from the PoC Server X to SIP/IP Core X)

The PoC Server X sends the SIP 200 "OK" response to SIP/IP Core X.

14. SIP 200 "OK" response (from SIP/IP Core X to SIP/IP Core A)

The SIP/IP Core X sends the SIP 200 "OK" response to the SIP/IP Core A.

15. SIP 200 "OK" response (from SIP/IP Core A to the PoC Server A)

The SIP/IP Core A sends the SIP 200 "OK" response to the PoC Server A.

16. SIP NOTIFY request (from the PoC Server A to the SIP/IP Core A)

The PoC Server A sends a SIP NOTIFY request towards the PoC Client A.

Request-URI sip:PoCClientA@networkA.net

SIP HEADERS

Content-Type: message/sipfrag;version=2.0

Subscription-State: terminated;reason=noresource

MIME BODY

SIP/2.0 200 OK

17. SIP NOTIFY request (from the SIP/IP Core A to the PoC Client A)

The SIP/IP Core A sends the NOTIFY request to the PoC Client A.

Request-URI sip:PoCClientA@networkA.net

SIP HEADERS

Content-Type: message/sipfrag;version=2.0

Subscription-State: terminated;reason=noresource

MIME BODY

SIP/2.0 200 OK

18. SIP 200 "OK" response (from the PoC Client A to the SIP/IP Core A)

The PoC Client A sends the SIP 200 "OK" response to the SIP/IP Core A.

19. SIP 200 "OK" response (from the SIP/IP Core A to the PoC Server A)

The SIP/IP Core A sends the SIP 200 "OK" response to the PoC Server A.

20. Terminating the PoC Session

Depending on the PoC Session release policy the PoC Server X disconnects all PoC Participants from the PoC Session as shown in Figure 18 "*Disconnecting a PoC Participant from a PoC Session, terminating flow – On-demand Session case*" or Figure 19 "*Disconnecting a PoC Participant from a PoC Session, terminating flow – Pre-established Session case*".

F.9.3 Terminating flow – On-demand Session Case

This subclause shows the procedure for disconnecting a PoC Participant in an on-going PoC Session for the On-demand Session case and when the PoC Server performing the Participating PoC Function acts as a B2BUA.

NOTE: In the case more than one PoC Participant is connected the procedure is repeated for each PoC Participant.

Figure 18 "*Disconnecting a PoC Participant from a PoC Session, terminating flow – On-demand Session case*" shows the signalling flow for the scenario.

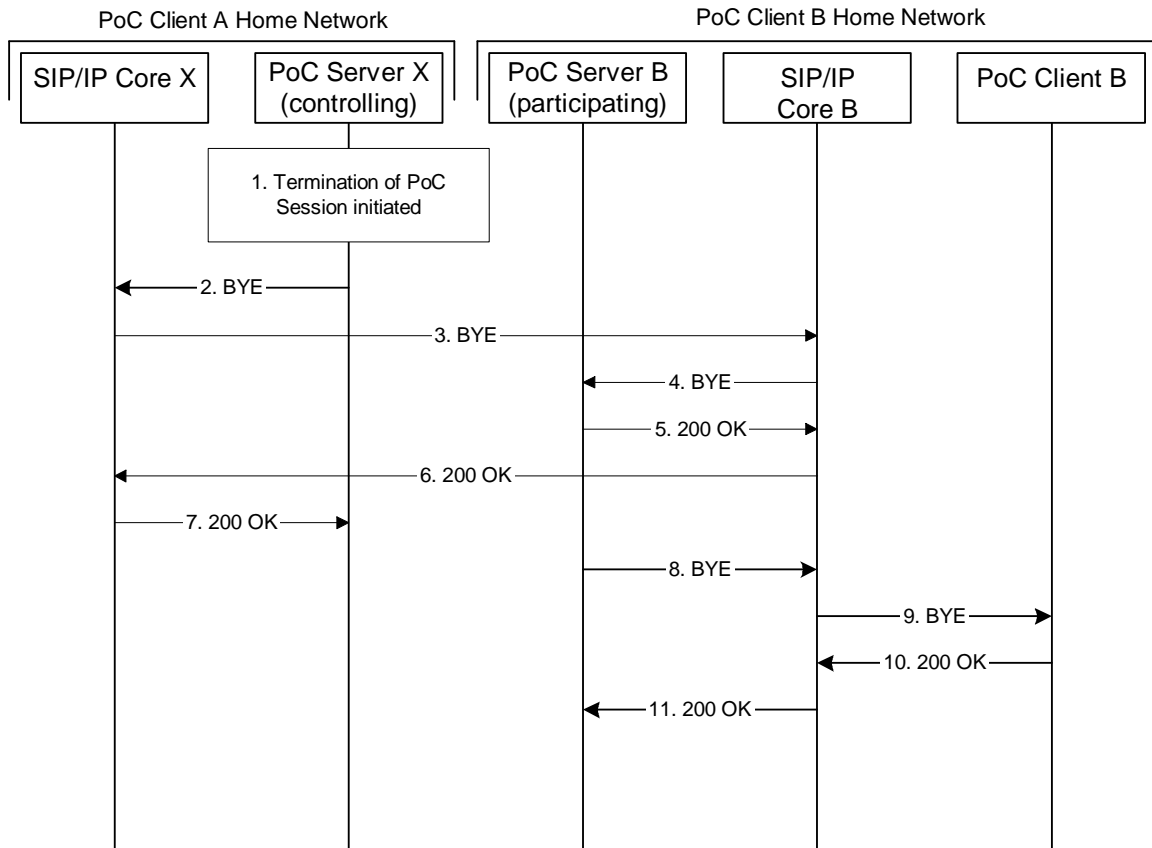

Figure 18: Disconnecting a PoC Participant from a PoC Session, terminating flow – On-demand Session case

The steps of the flows are as follows:

1. Release of PoC Session initiated

The PoC Server X (controlling) initiates the release of the PoC Session, e.g. when a PoC Participant leaves the PoC Session. Figure 16 "Leaving a PoC Session establishment, originating flow" Figure 17 "Leaving a PoC Session establishment, originating flow – Pre-established Session case" shows the signalling flow for the originating procedure.

2. SIP BYE request (from the PoC Server X to the SIP/IP Core X)

The PoC Server X sends the SIP BYE request to SIP/IP Core X.

Request-URI sip:xyz@PoC-ServerB.networkB.net

3. SIP BYE request (from the SIP/IP Core X to the SIP/IP Core B)

The SIP/IP Core X sends the SIP BYE request to SIP/IP Core B.

Request-URI sip:xyz@PoC-ServerB.networkB.net

4. SIP BYE request (from the SIP/IP Core B to the PoC Server B)

The SIP/IP Core B sends SIP BYE request to the PoC Server B.

Request-URI sip:xyz@PoC-ServerB.networkB.net

5. SIP 200 "OK" response (from the PoC Server B to the SIP/IP Core B)

The PoC Server B sends the 200 "OK" response to SIP/IP Core B.

6. SIP 200 "OK" response (from the SIP/IP Core B to the SIP/IP Core X)

The SIP/IP Core B sends the 200 "OK" response to SIP/IP Core X.

7. SIP 200 "OK" response (from the SIP/IP Core X to the PoC Server X)

The SIP/IP Core X sends the 200 "OK" response to the PoC Server X.

8. SIP BYE request (from the PoC Server B to the SIP/IP Core B)

The PoC Server B sends the SIP BYE request to SIP/IP Core B.

Request-URI sip:PoCClientB@networkB.net

9. SIP BYE request (from the SIP/IP Core B to the PoC Client B)

The SIP/IP Core B sends the SIP BYE request to the PoC Client B.

Request-URI sip:PoCClientB@networkB.net

10. SIP 200 "OK" response (from the PoC Client B to the SIP/IP Core B)

The PoC Client B sends the 200 "OK" response to SIP/IP Core B.

11. SIP 200 "OK" response (from the SIP/IP Core B to the PoC Server B)

The SIP/IP Core B sends the 200 "OK" response the PoC Server B.

F.9.4 Terminating flow – Pre-established Session Case

This subclause shows the procedure for disconnecting a PoC Participant in an on-going PoC Session for the Pre-established Session case.

NOTE: In the case more than one PoC Participant is connected the procedure is repeated for each PoC Participant.

Figure 19 "Disconnecting a PoC Participant from a PoC Session, terminating flow – Pre-established Session case" shows the signalling flow for the scenario.

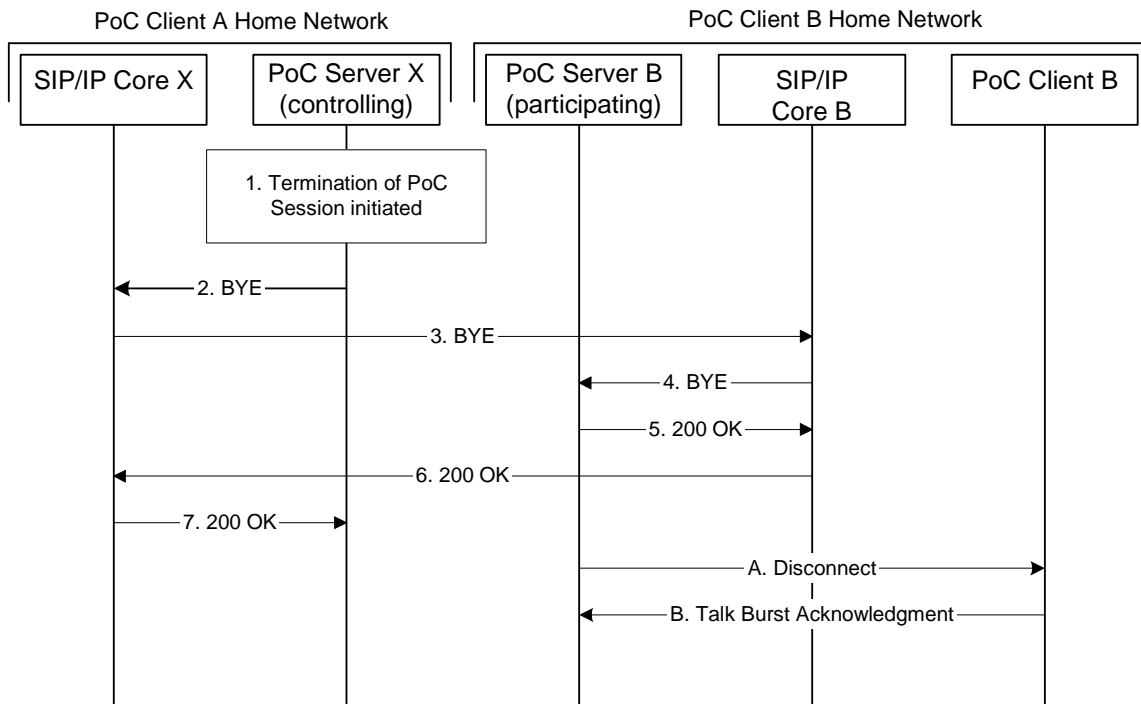

Figure 19: Disconnecting a PoC Participant from a PoC Session, terminating flow – Pre-established Session case

The steps of the flows are as follows:

1. release of PoC Session initiated

The PoC Server X (controlling) initiates the release of the PoC Session, e.g. when a PoC Participants leaves the PoC Session. Figure 16 "Leaving a PoC Session establishment, originating flow – On-demand Session case" or Figure 17 "Leaving a PoC Session establishment, originating flow – Pre-established Session case" shows the signalling flow for the originating procedure.

2. SIP BYE request (from the PoC Server X to the SIP/IP Core X)

The PoC Server X sends the SIP BYE request to the SIP/IP Core X.

Request-URI sip:PoC-UserB-1@PoCServerB.networkB.net

3. SIP BYE request (from the SIP/IP Core X to the SIP/IP Core B)

The SIP/IP Core X sends the SIP BYE request to the SIP/IP Core B.

Request-URI sip:PoC-UserB-1@PoCServerB.networkB.net

4. SIP BYE request (from the SIP/IP Core B to the PoC Server B)

The SIP/IP Core B sends the SIP BYE request to the PoC Server B.

Request-URI sip:PoC-UserB-1@PoCServerB.networkB.net

5. SIP 200 "OK" response (from the PoC Server B to the SIP/IP Core B)

The PoC Server B sends the SIP 200 "OK" response to the SIP/IP Core B.

6. SIP 200 "OK" response (from the SIP/IP Core B to the SIP/IP Core X)

The SIP/IP Core B sends the SIP 200 "OK" response to the SIP/IP Core X.

7. SIP 200 "OK" response (from the SIP/IP Core X to the PoC Server X)

The SIP/IP Core X sends the SIP 200 "OK" response to the PoC Server X.

A. TBCP Disconnect message (from the PoC Server B to the PoC Client B)

The PoC Server B sends the TBCP Disconnect message to the PoC Client B.

B. TBCP Talk Burst Acknowledgment message (from the PoC Client B to the PoC Server B)

The PoC Client B sends the TBCP Talk Burst Acknowledgment message to the PoC Server B.

Reason Code Accepted

F.10 Simultaneous PoC Sessions locking and priority setting

PoC Client A changes the locking and/or session priority parameters by sending a SIP UPDATE request or SIP re-INVITE request to the PoC Server.

The flow chart is valid for On-demand Session as well as for Pre-established Session case as specified in subclause 6.1.12 "*Simultaneous Session control procedures*".

Figure 20 "*PoC Client A modifies the Simultaneous PoC Session parameters*" shows how the PoC Client A is using the SIP re-INVITE request change the setting of the locking and/or the priority setting.

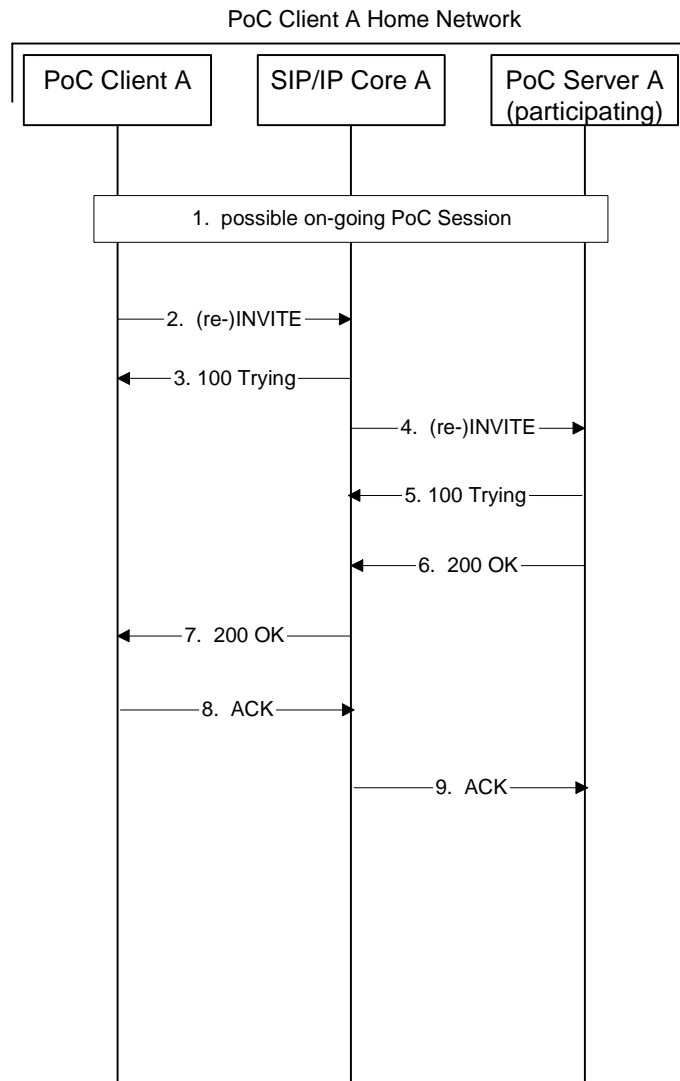

Figure 20: PoC Client A modifies the Simultaneous PoC Session parameters

The steps of the flows are as follows:

1. PoC Client A possible has a on-going PoC Session

PoC Client A possible has an on-going PoC Session established either on On-demand or Pre-established case.

2. SIP re-INVITE request (from PoC Client A to SIP/IP Core)

The SIP Client sends the SIP re-INVITE request to the SIP/IP Core A.

3. SIP re-INVITE request (from SIP/IP A Core to PoC Server A)

The SIP/IP Core forwards the SIP re-INVITE request to the PoC Server A (participating) according to the SIP/IP Core A routing principles.

4. SIP 200 "OK" response (from PoC Server A to SIP/IP Core A)

The PoC Server A analyses the Simultaneous PoC Sessions parameters and returns the agreed parameters as specified in subclause 7.3.1.12 "*Simultaneous PoC Session control procedures*".

5. SIP 200 "OK" response (from SIP/IP Core A to PoC Client A)

The SIP/IP Core A forwards the response to the PoC Client A. PoC Client A takes the parameter in the use as specified in subclause 6.1.12 "*Simultaneous Session control procedures*".

6. SIP ACK request (from PoC Client A to SIP/IP Core A)

7. SIP ACK request (from SIP/IP Core A to PoC Server A)

F.11 Placing media on or off hold

The signaling flow is valid for placing media on or off hold as specified in the subclauses 6.1.4.2 "*PoC Client placing media on hold*" and 6.1.4.3 "*PoC Client placing media off hold*" and 7.2.1.7 "*PoC Session modification*".

Prerequisite for the signaling flow is that the PoC Client has already an on-going PoC Session.

This flow is valid for On-demand as well as for Pre-established Session case.

Figure 21 "*Placing media on or off hold*" shows the signalling flow for the scenario.

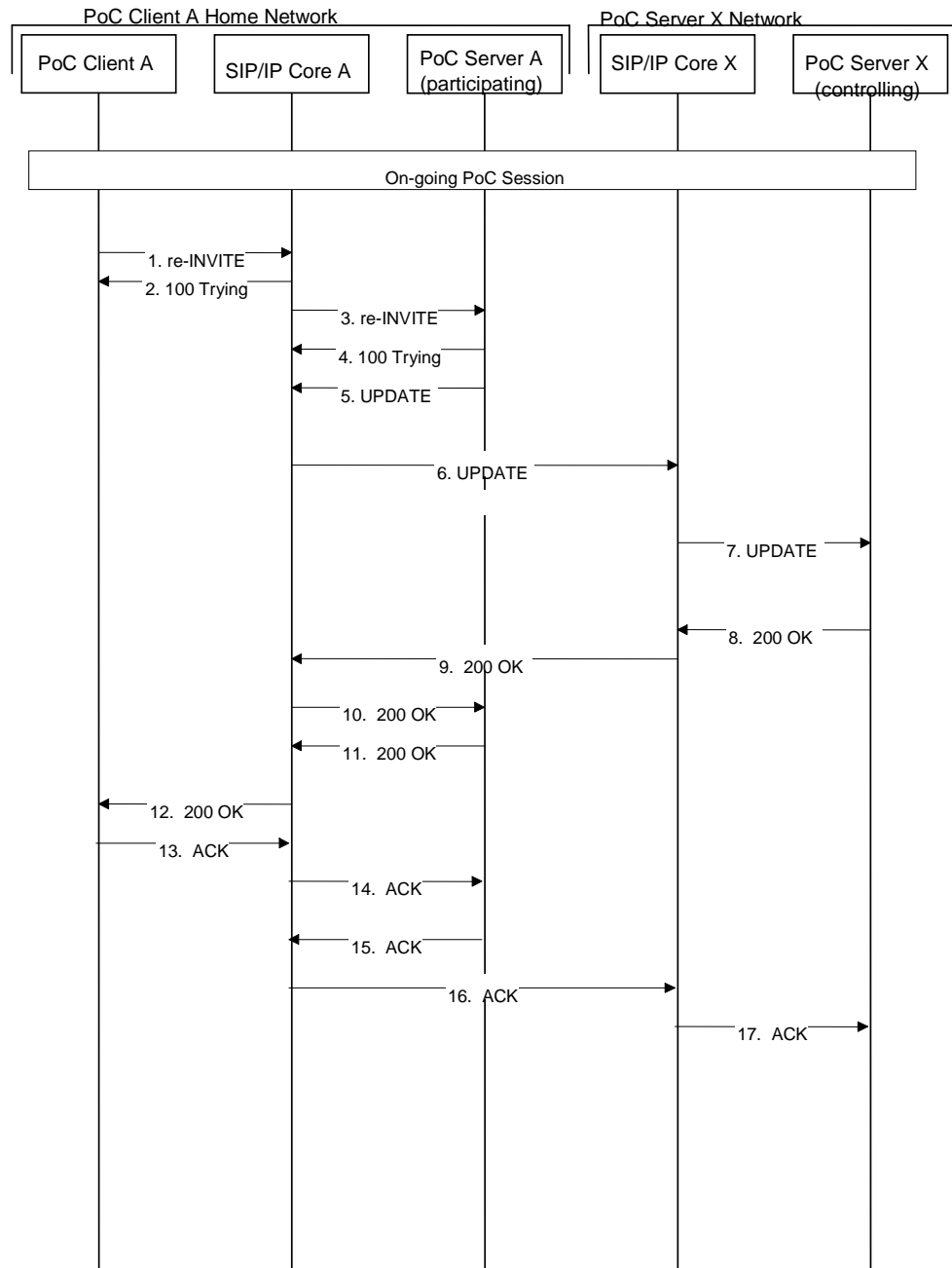

Figure 21: Placing media on or off hold

The steps of the flows are as follows:

1. SIP re-INVITE request (from PoC Client A to SIP/IP Core A)

The PoC Client receives a request from a PoC User to place media on or off hold. The PoC Client sends a SIP re-INVITE request to the SIP/IP Core A.

2. SIP 100 "Trying" response (SIP/IP Core A to PoC Client A)

The SIP/IP Core A responds to the SIP re-INVITE request with a SIP 100 "Trying" provisional response.

3. SIP re-INVITE request (from SIP/IP Core A to PoC Server A)

The SIP/IP Core A sends the SIP re-INVITE request to the PoC Server A.

4. SIP 100 "Trying" response (from PoC Server A to SIP/IP Core A)

The SIP/IP Core A responds to the SIP re-INVITE request with a SIP 100 "Trying" provisional response.

5. SIP UPDATE request (from PoC Server A to SIP/IP Core A)

Using the PoC Session Identity the PoC Server A determines that the Group PoC Session is owned by another PoC Server and sends the SIP UPDATE request to the SIP/IP Core A.

6. SIP UPDATE request (from SIP/IP Core A to SIP/IP Core X)

Based on the PoC Session Identity in the Request-URI the SIP/IP Core A sends the SIP UPDATE request to the SIP/IP Core X.

7. SIP UPDATE request (from SIP/IP Core X to PoC Server X)

The SIP/IP Core X sends the SIP UPDATE request to the PoC Server X.

8. SIP 200 "OK" response (from PoC Server X to SIP/IP Core X)

The PoC Server X authorizes the PoC Client A to place media on or off hold and sends the SIP 200 "OK" response to the SIP/IP Core.

9. SIP 200 "OK" response (from SIP/IP Core X to SIP/IP Core A)

The SIP/IP Core X sends the SIP 200 "OK" response to the SIP/IP Core A.

10. SIP 200 "OK" response (from SIP/IP Core A to PoC Server A)

The SIP/IP Core A sends the SIP 200 "OK" response to the SIP/IP Core A.

11. SIP 200 "OK" response (from PoC Server A to SIP/IP Core A)

The PoC Server A sends the SIP 200 "OK" response to SIP/IP Core A.

12. SIP 200 "OK" response (from SIP/IP Core A to PoC Client A)

The SIP/IP Core A sends the SIP 200 "OK" response to the PoC Client A.

13. SIP ACK request (from PoC Client A to SIP/IP Core A)

The PoC Client A acknowledges the SIP 200 "OK" response with a SIP ACK request sent to the SIP/IP Core A.

14. SIP ACK request (from SIP/IP Core A to PoC Server A)

The SIP/IP Core A forwards the SIP ACK request sent to the PoC Server A.

15. SIP ACK request (from PoC Server A to SIP/IP Core A)

The PoC Server A forwards the SIP ACK request sent to the SIP/IP Core A.

16. SIP ACK request (from SIP/IP Core A to SIP/IP Core X)

The SIP/IP Core A forwards the SIP ACK request sent to the SIP/IP Core X.

17. SIP ACK request (from SIP/IP Core X to PoC Server X)

The SIP/IP Core X forwards the SIP ACK request sent to the PoC Server X.

F.12 Session modifications

PoC Server X modifies the Media Parameters of the PoC Session by sending a SIP re-INVITE or a SIP UPDATE request towards the terminating PoC Client B as specified in subclause 7.2.1.7 "PoC Session modification" and 6.2.2 "PoC Client receiving a PoC Session modification request".

Figure 22 "PoC Session modifications" shows the message flow for the scenario.

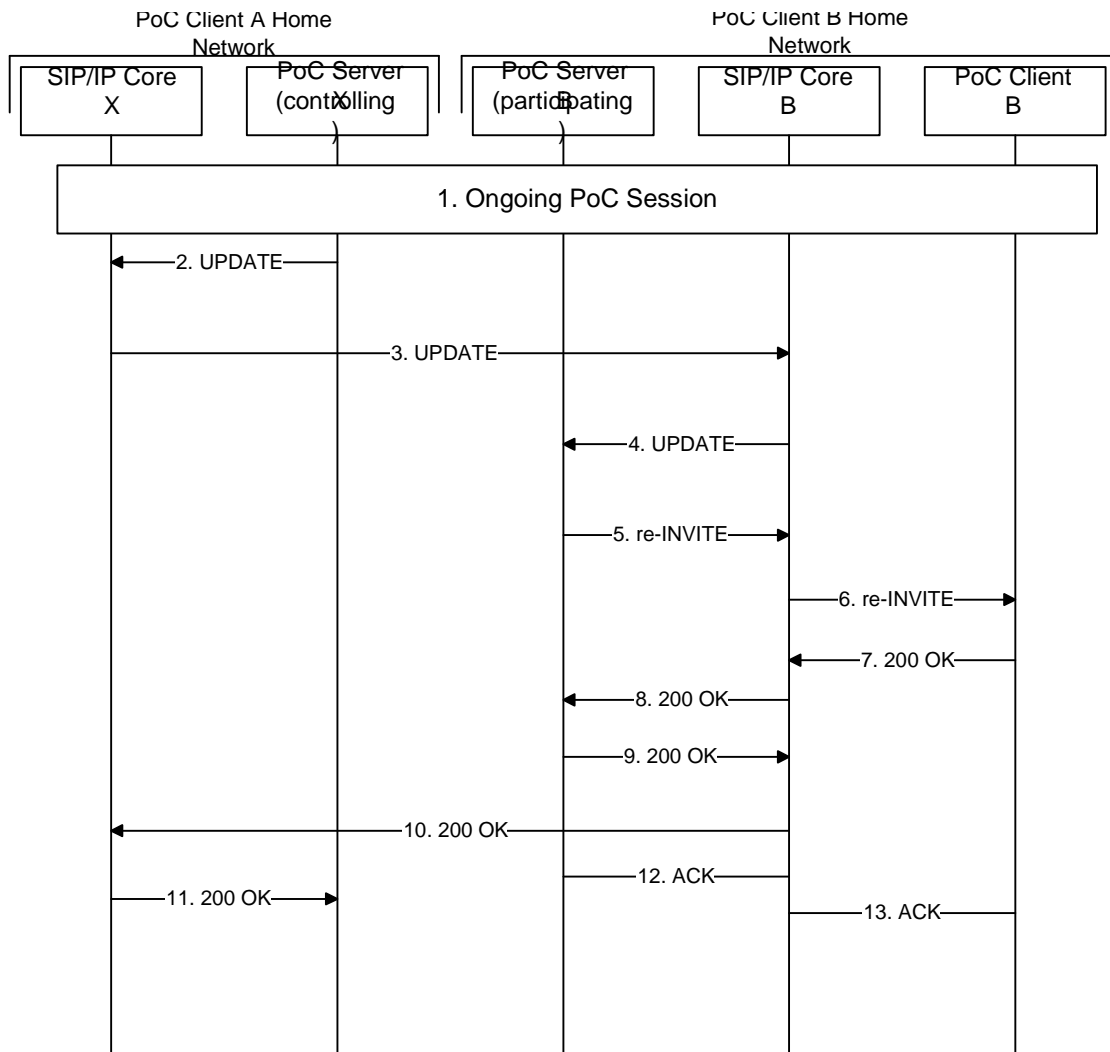

Figure 22: PoC Session modifications

The steps of the flow are as follows:

1. PoC Session is ongoing and PoC Server X decides to modify the Session
2. SIP UPDATE request (from PoC Server X to SIP/IP Core X)

PoC Server X is decided to modify the PoC Session by changing the Media Parameters. The PoC Server has learned during the establishment of the PoC Session that the PoC Server B supports the "UPDATE" method and sends a SIP UPDATE request towards PoC Client B.
3. SIP UPDATE request (from SIP/IP Core X to SIP/IP Core B)

The SIP/IP Core X forwards the SIP UPDATE request to the SIP/IP Core B.

4. SIP UPDATE request (from SIP/IP Core B to PoC Server B)

The SIP/IP Core B forwards the SIP UPDATE request to the PoC Server B.

5. SIP re-INVITE request (from PoC Server B to SIP/IP Core B)

The PoC Server B sends a SIP re-INVITE request to the SIP/IP Core B.

6. SIP re-INVITE request (from SIP/IP Core B to PoC Client B)

The SIP/IP Core B forwards the SIP re-INVITE request to the PoC Client B.

7. SIP 200 "OK" response (from PoC Client B to SIP/IP Core B)

The PoC Client B acknowledge the SIP re-INVITE request with a SIP 200 "OK" response to the SIP/IP Core B.

8. SIP 200 "OK" response (from SIP/IP Core B to PoC Server B)

The SIP/IP Core B forwards the SIP 200 "OK" response to PoC Server B.

9. SIP 200 "OK" response (from PoC Server B to SIP/IP Core B)

The PoC Server B responds to the SIP UPDATE request with a SIP 200 "OK" response to SIP/IP Core B.

10. SIP 200 "OK" response (from SIP/IP Core B to SIP/IP Core X)

The SIP/IP Core B forwards the SIP 200 "OK" response to SIP/IP Core X.

11. SIP 200 "OK" response (from SIP/IP Core X to PoC Server X)

The SIP/IP Core X forwards the SIP 200 "OK" response to PoC Server X.

12. SIP ACK request (from PoC Server B to SIP/IP Core B)

The PoC Server B acknowledges the SIP 200 "OK" response with a SIP ACK request sent to the SIP/IP Core B.

13. SIP ACK request (from SIP/IP Core B to PoC Client B)

The SIP/IP Core B forwards the SIP ACK request to PoC Client B.

F.13 Instant Personal Alert

This subclause shows an example of how one PoC User can send an Instant Personal Alert to another PoC User. The example includes authorization and Access Control.

F.13.1 Originating flow

This subclause describes the message flow between the sender of the Instant Personal Alert, i.e. the PoC Client A and the PoC Server A in the PoC Client A Home Network.

In this example the PoC Server A acts as proxy according to [RFC3261] and is not allowed to change the value of the headers User-Agent and Server, as specified in [RFC3428].

The flow is as shown in Figure 23 "*PoC Client A sends an Instant Personal Alert to PoC Client B*".

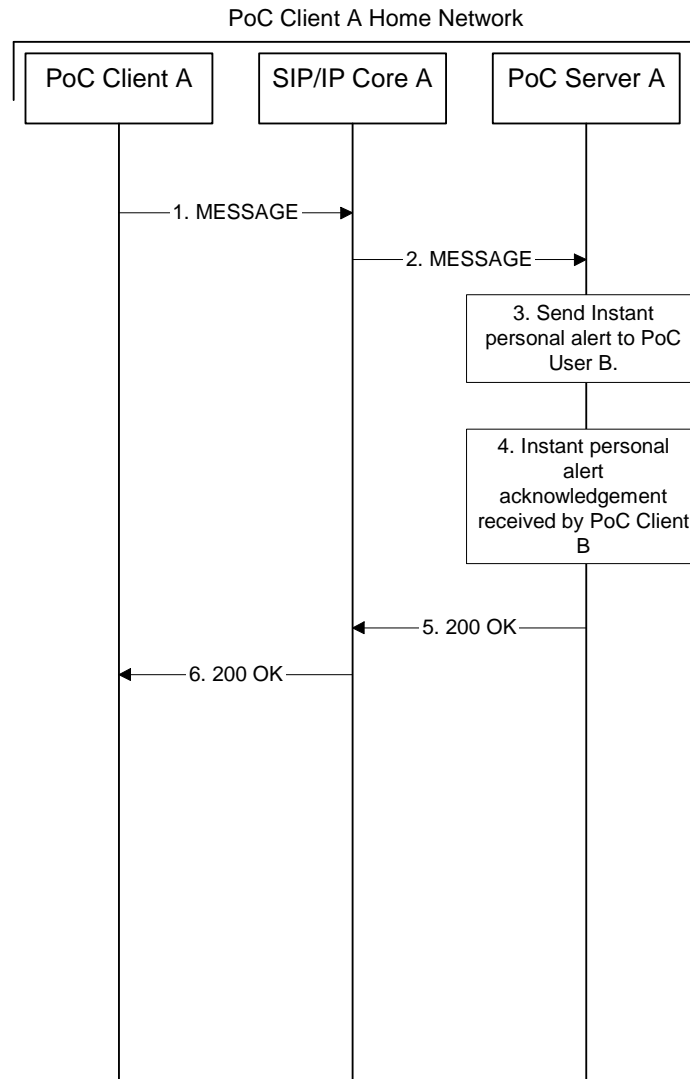

NOTE: Authorization of the Instant Personal Alert in the PoC Server A is optional and included in the Figure for completeness.

Figure 23: PoC Client A sends an Instant Personal Alert to PoC Client B

The steps of the flows are as follows:

1. SIP MESSAGE request (from PoC Client A to SIP/IP Core A)

The PoC Client A sends a SIP MESSAGE request to SIP/IP Core. The Request-URI includes the PoC Address of the PoC User B at a PoC Client B. The Accept-Contact header includes the PoC feature tag '+g.poc.talkburst'.

Request-URI sip:PoC-UserB@networkB.net

SIP HEADERS

P-Preferred-Identity: "PoC User A" <sip:PoC-UserA@networkA.net>

Accept-Contact: *;+g.poc.talkburst; require;explicit
User-Agent: PoC-client/OMA2.0 Acme-Talk5000/v1.01

2. SIP MESSAGE request (from SIP/IP Core A to PoC Server A)

The SIP/IP Core A sends the SIP MESSAGE request to the PoC Server A based on the PoC feature tag '+g.poc.talkburst' in the Accept-Contact header.

Request-URI sip:PoC-UserB@networkB.net

SIP HEADERS

P-Asserted-Identity: "PoC User A" <sip:PoC-UserA@networkA.net>
Accept-Contact: *;+g.poc.talkburst; require;explicit
User-Agent: PoC-client/OMA2.0 Acme-Talk5000/v1.01

3. The Sending of Instant Personal Alert (from PoC Server A to PoC Client B Network)

The PoC Server A authorizes the PoC User A at the PoC Client A to send an Instant Personal Alert and initiates the sending of the Instant Personal Alert to the PoC Client B as described in subclause F.13.2 "Terminating flow".

4. The Receipt of Instant Personal Alert acknowledgement (from PoC Client B Network to PoC Server A)

The PoC Server A receives an acknowledgment from the PoC Client B Network that the PoC Client B has received the Instant Personal Alert.

5. SIP 200 "OK" response (from PoC Server A to SIP/IP Core A)

A SIP 200 "OK" response is sent by the PoC Server A to SIP/IP Core A. The PoC Server A forwards the value of the Server header received from PoC Client B network.

SIP HEADERS

P-Asserted-Identity: <sip:PoC-ClientB@networkB.net>
Server: PoC-client/OMA2.0 Acme-Talk5000/v1.01

6. SIP 200 "OK" response (from SIP/IP Core A to PoC Client A)

SIP/IP Core A forwards the SIP 200 "OK" response to PoC Client A.

SIP HEADERS

P-Asserted-Identity: <sip:PoC-ClientB@networkB.net>
Server: PoC-client/OMA2.0 Acme-Talk5000/v1.01

F.13.2 Terminating flow

This subclause describes the message flow between the receiver of the Instant Personal Alert, i.e. the PoC Client B and the PoC Server B in the PoC Client B Home Network.

In this example the PoC Server B acts as proxy according to [RFC3261] and is not allowed to change the value of the headers User-Agent and Server, as specified in [RFC3428].

The flow is as shown in Figure 24 "PoC Client B receives an Instant Personal Alert from PoC Client A".

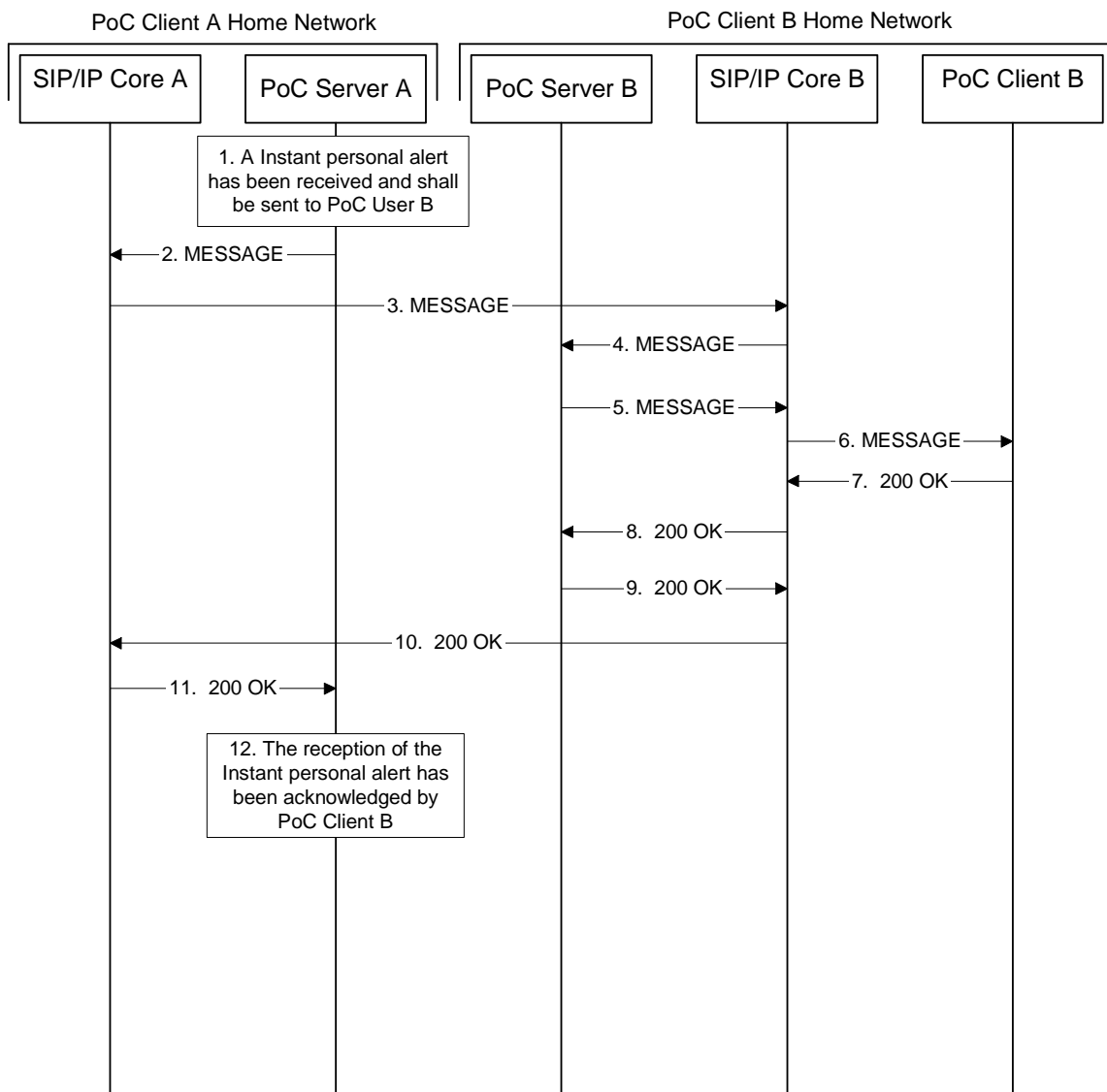

NOTE: Access Control of the Instant personal alert in the PoC Server B is optional and included in the figure for completeness.

Figure 24: PoC Client B receives an Instant Personal Alert from PoC Client A

The steps of the flows are as follows:

1. The receiving and sending of Instant Personal Alert

The PoC Server A receives an authorized request from a PoC User A to send an Instant Personal Alert to the PoC User B.

2. SIP MESSAGE request (from PoC Server A to SIP/IP Core A)

The PoC Server A sends a SIP MESSAGE request to the SIP/IP Core A. The Request-URI includes the PoC Address of the PoC User B and an Accept-Contact header with the PoC feature tag '+g.poc.talkburst'.

Request-URI sip:PoC-UserB@networkB.net

SIP HEADERS

P-Asserted-Identity: "PoC User A" <sip:PoC-UserA@networkA.net>

Accept-Contact: *,+g.poc.talkburst; require;explicit

User-Agent: PoC-client/OMA2.0 Acme-Talk5000/v1.01

3. SIP MESSAGE request (from SIP/IP Core A to SIP/IP Core B)

The SIP/IP Core A sends the SIP MESSAGE request to the SIP/IP Core B based on the PoC Address of the PoC User B.

Request-URI sip:PoC-UserB@networkB.net

SIP HEADERS

P-Asserted-Identity: "PoC User A" <sip:PoC-UserA@networkA.net>

Accept-Contact: *,+g.poc.talkburst; require;explicit

User-Agent: PoC-client/OMA2.0 Acme-Talk5000/v1.01

4. SIP MESSAGE request (from SIP/IP Core B to PoC Server B)

The SIP/IP Core B sends the SIP MESSAGE request to the PoC Server B based on the PoC feature tag '+g.poc.talkburst' in the Accept Contact.

Request-URI sip:PoC-UserB@networkB.net

SIP HEADERS

P-Asserted-Identity: "PoC User A" <sip:PoC-UserA@networkA.net>

Accept-Contact: *,+g.poc.talkburst; require;explicit

User-Agent: PoC-client/OMA2.0 Acme-Talk5000/v1.01

5. SIP MESSAGE request (from PoC Server B to SIP/IP Core B)

The PoC Server B performs Access Control and determines that the PoC User A at the PoC Client A is authorized to send an Instant Personal Alert to the PoC User B. The PoC Server B sends the SIP MESSAGE request to the SIP/IP Core.

Request-URI sip:PoC-UserB@networkB.net

SIP HEADERS

P-Asserted-Identity: "PoC User A" <sip:PoC-UserA@networkA.net>

Accept-Contact: *,+g.poc.talkburst; require;explicit

User-Agent: PoC-client/OMA2.0 Acme-Talk5000/v1.01

6. SIP MESSAGE request (from SIP/IP Core B to PoC Client B)

The SIP IP/Core B sends the SIP MESSAGE to the PoC Client B based on information stored during registration.

Request-URI sip:PoC-UserB@networkB.net

SIP HEADERS

P-Asserted-Identity: "PoC User A" <sip:PoC-UserA@networkA.net>

Accept-Contact: *,+g.poc.talkburst; require;explicit

User-Agent: PoC-client/OMA2.0 Acme-Talk5000/v1.01

7. SIP 200 "OK" response (from PoC Client B to SIP/IP Core B)

The PoC Client B sends a SIP 200 "OK" response to the SIP/IP Core B in order to acknowledge that the Instant Personal Alert was received.

SIP HEADERS

P-Asserted-Identity: <sip:PoC-ClientB@networkA.net>

Server: PoC-client/OMA2.0 Acme-Talk5000/v1.01

8. SIP 200 "OK" response (from SIP/IP Core B to PoC Server B)

The SIP/IP Core B forwards the SIP 200 "OK" response to the PoC Server B.

SIP HEADERS

P-Asserted-Identity: <sip:PoC-ClientB@networkB.net>

Server: PoC-client/OMA2.0 Acme-Talk5000/v1.01

9. SIP 200 "OK" response (from PoC Server B to SIP/IP Core B)

The PoC Server B forwards the SIP 200 "OK" response to the SIP/IP Core B.

SIP HEADERS

P-Asserted-Identity: <sip:PoC-ClientB@networkB.net>
Server: PoC-client/OMA2.0 Acme-Talk5000/v1.01

10. SIP 200 "OK" response (from SIP/IP Core B to SIP/IP Core A)

The SIP/IP Core B forwards the SIP 200 "OK" response to the SIP/IP Core A.

SIP HEADERS

P-Asserted-Identity: <sip:PoC-ClientB@networkB.net>
Server: PoC-client/OMA2.0 Acme-Talk5000/v1.01

11. "OK" response (from SIP/IP Core A to PoC Server A)

The SIP/IP Core A forwards the SIP 200 "OK" response to the PoC Server A.

SIP HEADERS

P-Asserted-Identity: <sip:PoC-ClientB@networkB.net>
Server: PoC-client/OMA2.0 Acme-Talk5000/v1.01

12. The sending of the acknowledgement (from PoC Server A to PoC Client A)

The PoC Server A sends the acknowledgment to the PoC Client A as shown in Figure 23 "*PoC Client A sends an Instant Personal Alert to PoC Client B*".

F.14 Event Subscriptions

The following subclauses show how a PoC Client or a PoC Server performing the Participating PoC Function can subscribe to Participant Information during a PoC Session.

F.14.1 PoC Client subscribing to Participant Information

This subclause shows an example on how one PoC Client subscribes to Participant Information during an ongoing PoC Session. The flow is as shown in Figure 25 "*A PoC Client subscribes to Participant Information*".

PoC User D requested anonymity at the PoC Session establishment.

QoE Profiles feature is used in this flow so the Local QoE Profile used by each Participant is sent in the Participant Information.

PoC Clients B and D support FDCFO, while PoC Client C does not support FDCFO.

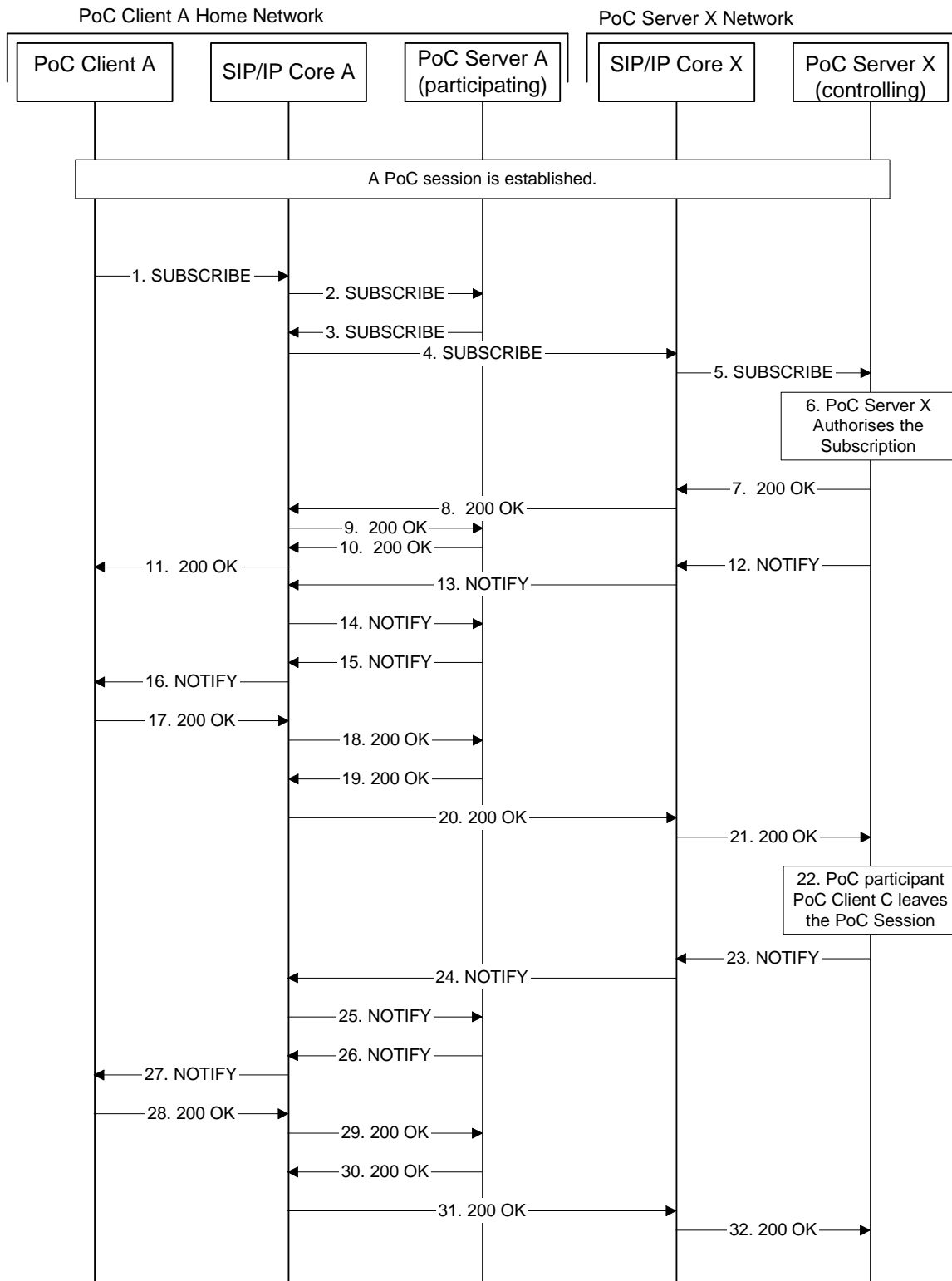

Figure 25: A PoC Client subscribes to Participant Information

The steps of the flows are as follows:

1. SIP SUBSCRIBE request (from PoC Client A to SIP/IP Core A)

A PoC Client A sends the SIP SUBSCRIBE request to the SIP/IP Core. The Request URI can include a PoC Group Identity of a PoC Group or a PoC Session Identity. In the following example a PoC Group Identity is used.

Request-URI sip:OMA-Golf-buddies@networkX.net

SIP HEADERS

P-Preferred-Identity: "PoC User A" <sip:PoC-UserA@networkA.net>

User-Agent: PoC-client/OMA2.0 Acme-Talk5000/v1.01

Accept-Contact: *,+g.poc.talkburst; require;explicit

Contact: <sip:PoC-ClientA@networkA.net>

Event: conference

Expires 3600

2. SIP SUBSCRIBE request (from SIP/IP Core A to PoC Server A)

The SIP/IP Core A sends the SIP SUBSCRIBE request to the PoC Server A performing the Participating PoC Function based on the PoC feature tag '+g.poc.talkburst' in the Accept-Contact header.

Request-URI sip:OMA-Golf-buddies@networkX.net

SIP HEADERS

P-Asserted-Identity: "PoC User A" <sip:PoC-UserA@networkA.net>

User-Agent: PoC-client/OMA2.0 Acme-Talk5000/v1.01

Accept-Contact: *,+g.poc.talkburst; require;explicit

Contact: <sip:PoC-ClientA@networkA.net>

Event: conference

Expires 3600

3. SIP SUBSCRIBE request (from PoC Server A to SIP/IP Core A)

The PoC Server A performing the Participating PoC Function does not recognize the PoC Group Identity as its own and sends the SIP SUBSCRIBE request to the SIP/IP Core A.

Request-URI sip:OMA-Golf-buddies@networkX.net

SIP HEADERS

P-Asserted-Identity: "PoC User A" <sip:PoC-UserA@networkA.net>
User-Agent: PoC-serv/OMA2.0
Accept-Contact: *,+g.poc.talkburst; require;explicit
Contact: <sip:PoC-ServerA@networkA.net>
Event: conference
Expires: 3600

4. SIP SUBSCRIBE request (from SIP/IP Core A to SIP/IP Core X)

The SIP/IP Core A sends the SIP SUBSCRIBE request to the SIP/IP Core X based on the Request-URI.

Request-URI sip:OMA-Golf-buddies@networkX.net

SIP HEADERS

P-Asserted-Identity: "PoC User A" <sip:PoC-UserA@networkA.net>
User-Agent: PoC-serv/OMA2.0
Accept-Contact: *,+g.poc.talkburst; require;explicit
Contact: <sip:PoC-ServerA@networkA.net>
Event: conference
Expires: 3600

5. SIP SUBSCRIBE request (from SIP/IP Core X to PoC Server X)

The SIP/IP Core X sends the SIP SUBSCRIBE request to the PoC Server X performing the Controlling PoC Function based on the PoC Group Identity in the Request-URI and the PoC feature tag '+g.poc.talkburst' in the Accept-Contact header.

Request-URI sip:OMA-Golf-buddies@networkX.net

SIP HEADERS

P-Asserted-Identity: "PoC User A" <sip:PoC-UserA@networkA.net>
User-Agent: PoC-serv/OMA2.0
Accept-Contact: *,+g.poc.talkburst; require;explicit
Contact: <sip:PoC-ServerA@networkA.net>

Event: conference
Expires 3600

6. The authorization (PoC Server X)

The PoC Server X authorizes the PoC User at the PoC Client A to receive Participant Information. The authorization can, for example, be based on membership in the PoC Group, number of PoC Users already subscribing to the Participant Information or if the PoC User is a Participant in the ongoing PoC Session.

7. SIP 200 "OK" response (from PoC Server X to SIP/IP Core X)

The authorization is successful and the PoC Server X (performing the Controlling PoC Function) sends the SIP 200 "OK" response to the SIP SUBSCRIBE request to SIP/IP Core X.

SIP HEADERS

P-Asserted-Identity: <sip:PoC-ServerX@networkX.net>
Server: PoC-serv/OMA2.0
Supported: norefersub

8. SIP 200 "OK" response (from SIP/IP Core X to SIP/IP Core A)

The SIP/IP Core X forwards the SIP 200 "OK" response to the SIP/IP Core A.

SIP HEADERS

P-Asserted-Identity: <sip:PoC-ServerX@networkX.net>
Server: PoC-serv/OMA2.0
Supported: norefersub

9. SIP 200 "OK" response (from SIP/IP Core A to PoC Server A)

The SIP/IP Core A forwards the SIP 200 "OK" response to the PoC Server A.

SIP HEADERS

P-Asserted-Identity: <sip:PoC-ServerX@networkX.net>
Server: PoC-serv/OMA2.0
Supported: norefersub

10. SIP 200 "OK" response (from PoC Server A to SIP/IP Core A)

The PoC Server A forwards the SIP 200 "OK" response to the SIP/IP Core A.

SIP HEADERS

P-Asserted-Identity: <sip:PoC-ServerX@networkX.net>
Server: PoC-serv/OMA2.0
Supported: norefersub

11. SIP 200 "OK" response (from SIP/IP Core A to PoC Client A)

The SIP/IP Core A forwards the SIP 200 "OK" response to the PoC Client A.

SIP HEADERS

P-Asserted-Identity: <sip:PoC-ServerX@networkX.net>
Server: PoC-serv/OMA2.0
Supported: norefersub

12 SIP NOTIFY request (from PoC Server X to SIP/IP Core X)

The PoC Server X performing the Controlling PoC Function collects information about all Participants in the PoC Session and sends a complete list of all Participants (referred to as a "full" output in [RFC4575]) in a SIP NOTIFY request to the SIP/IP Core X.

Request-URI sip:PoC-ServerA@networkA.net

SIP HEADERS

Contact <sip:PoC-ServerX@networkX.net >
Event: conference
Content-Type: application/conference-info+xml
Subscription-State: active;expires=3600

XML MIME BODY

```
<?xml version="1.0" encoding="UTF-8"?>
```

```
<conference-info xmlns="urn:ietf:params:xml:ns:conference-info"
  xmlns:xsi="http://www.w3.org/2001/XMLSchema-instance"
  xmlns:piind="urn:oma:xml:poc:participant-info-ind"
  xsi:schemaLocation="urn:ietf:params:xml:ns:conference-info"
  entity="sip:OMA-Golf-buddies@networkX.net" state="full" version="1">
```

```
<users>
  <user entity="sip:PoC-UserB@networkB.net" state="full">
    <display-text>PoC User B</display-text>
    <endpoint entity="sip:PoC-ClientB@networkB.net" piind:LocalQoE="Basic"
piind:FDCFOSupported="true">
      <status>connected</status>
      <media id="1">
        <type>audio</type>
        <status>sendrecv</status>
      </media>
    </endpoint>
  </user>

  <user entity="sip:PoC-UserC@networkC.net" state="full">
    <display-text>PoC User C</display-text>
    <endpoint entity="sip:PoC-ClientC@networkC.net"
piind:LocalQoE="Premium">
      <status>connected</status>
      <media id="1">
        <type>audio</type>
        <status>sendrecv</status>
      </media>
    </endpoint>
  </user>

  <user entity="sip:anonymous-1@anonymous.invalid" state="full">
    <display-text>anonymous-1</display-text>
    <endpoint entity="sip:anonymous-1@anonymous.invalid"
piind:LocalQoE="Premium" piind:FDCFOSupported="true">
      <status>connected</status>
      <media id="1">
        <type>audio</type>
```

```

        <status>sendrecv</status>
    </media>
</endpoint>
</user>
</users>
</conference-info>

```

13. SIP NOTIFY request (from SIP/IP Core X to SIP/IP Core A)

The SIP/IP Core X forwards the SIP NOTIFY request to SIP/IP Core A.

Request-URI sip:PoC-ServerA@networkA.net

SIP HEADERS

Contact <sip:PoC-ServerX@networkX.net >

Event: conference

Content-Type: application/conference-info+xml

Subscription-State: active;expires=3600

XML MIME BODY

```

<?xml version="1.0" encoding="UTF-8"?>

<conference-info xmlns="urn:ietf:params:xml:ns:conference-info"
  xmlns:xsi="http://www.w3.org/2001/XMLSchema-instance"
  xmlns:piind="urn:oma:xml:poc:participant-info-ind"
  xsi:schemaLocation="urn:ietf:params:xml:ns:conference-info"
  entity="sip:OMA-Golf-buddies@networkX.net" state="full" version="1">

  <users>

    <user entity="sip:PoC-UserB@networkB.net" state="full">
      <display-text>PoC User B</display-text>
      <endpoint entity="sip:PoC-ClientB@networkB.net" piind:LocalQoE="Basic"
        piind:FDCFOSupported="true">
        <status>connected</status>

```

```
<media id="1">
  <type>audio</type>
  <status>sendrecv</status>
</media>
</endpoint>
</user>

<user entity="sip:PoC-UserC@networkC.net" state="full">
  <display-text>PoC User C</display-text>
  <endpoint entity="sip:PoC-ClientC@networkC.net"
  piind:LocalQoE="Premium">
    <status>connected</status>
    <media id="1">
      <type>audio</type>
      <status>sendrecv</status>
    </media>
  </endpoint>
</user>

<user entity="sip:anonymous-1@anonymous.invalid" state="full">
  <display-text>anonymous-1</display-text>
  <endpoint entity="sip:anonymous-1@anonymous.invalid"
  piind:LocalQoE="Premium" piind:FDCFOSupported="true">
    <status>connected</status>
    <media id="1">
      <type>audio</type>
      <status>sendrecv</status>
    </media>
  </endpoint>
</user>
</users>
</conference-info>
```

14. SIP NOTIFY request (from SIP/IP Core A to PoC Server A)

The SIP/IP Core A forwards the SIP NOTIFY request to the PoC Server A.

Request-URI sip:PoC-ServerA@networkA.net

SIP HEADERS

Contact <sip:PoC-ServerX@networkX.net >

Event: conference

Content-Type: application/conference-info+xml

Subscription-State: active;expires=3600

XML MIME BODY

```
<?xml version="1.0" encoding="UTF-8"?>
```

```
<conference-info xmlns="urn:ietf:params:xml:ns:conference-info"
  xmlns:xsi="http://www.w3.org/2001/XMLSchema-instance"
  xmlns:piind="urn:oma:xml:poc:participant-info-ind"
  xsi:schemaLocation="urn:ietf:params:xml:ns:conference-info"
  entity="sip:OMA-Golf-buddies@networkX.net" state="full" version="1">
```

```
<users>
```

```
<user entity="sip:PoC-UserB@networkB.net" state="full">
```

```
<display-text>PoC User B</display-text>
```

```
<endpoint entity="sip:PoC-ClientB@networkB.net" piind:LocalQoE="Basic"
piind:FDCFOSupported="true">
```

```
<status>connected</status>
```

```
<media id="1"> <type>audio</type>
```

```
<status>sendrecv</status>
```

```
</media>
```

```
</endpoint>
```

```
</user>
```

```
<user entity="sip:PoC-UserC@networkC.net" state="full">
```

```

    <display-text>PoC User C</display-text>

    <endpoint entity="sip:PoC-ClientC@networkC.net"
    piind:LocalQoE="Premium">
        <status>connected</status>
        <media id="1">
            <type>audio</type>
            <status>sendrecv</status>
        </media>
    </endpoint>
</user>

<user entity="sip:anonymous-1@anonymous.invalid" state="full">
    <display-text>anonymous-1</display-text>
    <endpoint entity="sip:anonymous-1@anonymous.invalid"
    piind:LocalQoE="Premium" piind:FDCFOSupported="true">
        <status>connected</status>
        <media id="1">
            <type>audio</type>
            <status>sendrecv</status>
        </media>
    </endpoint>
</user>
</users>

</conference-info>

```

15. SIP NOTIFY request (from PoC Server A to SIP/IP Core A)

The PoC Server A forwards the SIP NOTIFY request to the SIP/IP Core A.

Request-URI sip:PoC-ClientA@networkA.net

SIP HEADERS

Contact <sip:PoC-ServerA@networkA.net >

Event: conference

Content-Type: application/conference-info+xml

Subscription-State: active;expires=3600

XML MIME BODY

```
<?xml version="1.0" encoding="UTF-8"?>

<conference-info xmlns="urn:ietf:params:xml:ns:conference-info"
  xmlns:xsi="http://www.w3.org/2001/XMLSchema-instance"
  xmlns:piind="urn:oma:xml:poc:participant-info-ind"
  xsi:schemaLocation="urn:ietf:params:xml:ns:conference-info"
  entity="sip:OMA-Golf-buddies@networkX.net" state="full" version="1">

  <users>
    <user entity="sip:PoC-UserB@networkB.net" state="full">
      <display-text>PoC User B</display-text>
      <endpoint entity="sip:PoC-ClientB@networkB.net" piind:LocalQoE="Basic"
        piind:FDCFOSupported="true">
        <status>connected</status>
        <media id="1">
          <type>audio</type>
          <status>sendrecv</status>
        </media>
      </endpoint>
    </user>

    <user entity="sip:PoC-UserC@networkC.net" state="full">
      <display-text>PoC User C</display-text>
      <endpoint entity="sip:PoC-ClientC@networkC.net"
        piind:LocalQoE="Premium">
        <status>connected</status>
        <media id="1">
          <type>audio</type>
          <status>sendrecv</status>
```

```

        </media>
    </endpoint>
</user>

<user entity="sip:anonymous-1@anonymous.invalid" state="full">
    <display-text>anonymous-1</display-text>
    <endpoint entity="sip:anonymous-1@anonymous.invalid"
    piind:LocalQoE="Premium" piind:FDCFOSupported="true">
        <status>connected</status>
        <media id="1">
            <type>audio</type>
            <status>sendrecv</status>
        </media>
    </endpoint>
</user>

</users>
</conference-info>

```

16. SIP NOTIFY request (from SIP/IP Core A to PoC Client A)

The SIP/IP Core A forwards the SIP NOTIFY request to the PoC Client A.

Request-URI sip:PoC-ClientA@networkA.net

SIP HEADERS

Contact <sip:PoC-ServerA@networkA.net >

Event: conference

Content-Type: application/conference-info+xml

Subscription-State: active;expires=3600

XML MIME BODY

```
<?xml version="1.0" encoding="UTF-8"?>
```



```
<conference-info xmlns="urn:ietf:params:xml:ns:conference-info"
  xmlns:xsi="http://www.w3.org/2001/XMLSchema-instance"
  xmlns:piind="urn:oma:xml:poc:participant-info-ind"
  xsi:schemaLocation="urn:ietf:params:xml:ns:conference-info"
  entity="sip:OMA-Golf-buddies@networkX.net" state="full" version="1">

<users>
  <user entity="sip:PoC-UserB@networkB.net" state="full">
    <display-text>PoC User B</display-text>
    <endpoint entity="sip:PoC-ClientB@networkB.net" piind:LocalQoE="Basic"
      piind:FDCFOSupported="true">
      <status>connected</status>
      <media id="1">
        <type>audio</type>
        <status>sendrecv</status>
      </media>
    </endpoint>
  </user>
  <user entity="sip:PoC-UserC@networkC.net" state="full">
    <display-text>PoC User C</display-text>
    <endpoint entity="sip:PoC-ClientC@networkC.net"
      piind:LocalQoE="Premium">
      <status>connected</status>
      <media id="1">
        <type>audio</type>
        <status>sendrecv</status>
      </media>
    </endpoint>
  </user>

  <user entity="sip:anonymous-1@anonymous.invalid" state="full">
    <display-text>anonymous-1</display-text>
    <endpoint entity="sip:anonymous-1@anonymous.invalid"
```

```

piind:LocalQoE="Premium" piind:FDCFOSupported="true">
  <status>connected</status>
  <media id="1">
    <type>audio</type>
    <status>sendrecv</status>
  </media>
</endpoint>
</user>

</users>
</conference-info>

```

17. SIP 200 "OK" response (from PoC Client A to SIP/IP Core A)

The PoC Client A sends the SIP 200 "OK" response to the SIP NOTIFY request to the SIP/IP Core A.

18. SIP 200 "OK" response (from SIP/IP Core A to PoC Server A)

The SIP/IP Core A forwards the SIP 200 "OK" response to the PoC Server A.

19. SIP 200 "OK" response (from PoC Server A to SIP/IP Core A)

The PoC Server A forwards the SIP 200 "OK" response to the SIP/IP Core A.

20. SIP 200 "OK" response (from SIP/IP Core A to SIP/IP Core X)

The SIP/IP Core A forwards the SIP 200 "OK" response to the SIP/IP Core X.

21. SIP 200 "OK" response (from SIP/IP Core X to PoC Server X)

The SIP/IP Core X forwards the SIP 200 "OK" response to the PoC Server X.

The following steps only happen if the subscription is active.

22. The Participant PoC Client C leaves the PoC Session.**23. SIP NOTIFY request (from PoC Server X to SIP/IP Core X)**

The PoC Server X performing the Controlling PoC Function sends a SIP NOTIFY request to the SIP/IP Core X. This time only information about the Participant leaving the PoC Session is sent (referred to by the [RFC4575] as a "partial" output).

Request-URI sip:PoC-ServerA@networkA.net

SIP HEADERS

Contact <sip:PoC-ServerX@networkX.net >

Event: conference
Content-Type: application/conference-info+xml
Subscription-State: active;expires=3600

XML MIME BODY

```
<?xml version="1.0" encoding="UTF-8"?>

  <conference-info xmlns="urn:ietf:params:xml:ns:conference-info"
    xmlns:xsi="http://www.w3.org/2001/XMLSchema-instance"
    xmlns:piind="urn:oma:xml:poc:participant-info-ind"
    xsi:schemaLocation="urn:ietf:params:xml:ns:conference-info"
    entity="sip:OMA-Golf-buddies@networkX.net" state="partial"
    version="1">
    <users>
      <user entity="sip:PoC-UserC@networkC.net" state="full">
        <display-text>PoC User C</display-text>
        <endpoint entity="sip:PoC-ClientC@networkC.net"
          piind:LocalQoE="Premium">
          <status>disconnected</status>
        </endpoint>
      </user>
    </users>
  </conference-info>
```

24. SIP NOTIFY request (from SIP/IP Core X to SIP/IP Core A)

The SIP/IP Core X forwards the SIP NOTIFY request to the SIP/IP Core A.

Request-URI sip:PoC-ServerA@networkA.net

SIP HEADERS

Contact <sip:PoC-ServerX@networkX.net >
Event: conference
Content-Type: application/conference-info+xml

Subscription-State: active;expires=3600

XML MIME BODY

```
<?xml version="1.0" encoding="UTF-8"?>

  <conference-info xmlns="urn:ietf:params:xml:ns:conference-info"
    xmlns:xsi="http://www.w3.org/2001/XMLSchema-instance"
    xmlns:piind="urn:oma:xml:poc:participant-info-ind"
    xsi:schemaLocation="urn:ietf:params:xml:ns:conference-info"
    entity="sip:OMA-Golf-buddies@networkX.net" state="partial"
    version="1">
    <users>
      <user entity="sip:PoC-UserC@networkC.net" state="full">
        <display-text>PoC User C</display-text>
        <endpoint entity="sip:PoC-ClientC@networkC.net"
          piind:LocalQoE="Premium">
          <status>disconnected</status>
        </endpoint>
      </user>
    </users>
  </conference-info>
```

25. SIP NOTIFY request (from SIP/IP Core A to PoC Server A)

The SIP/IP Core A forwards the SIP NOTIFY request to the PoC Server A.

Request-URI sip:PoC-ServerA@networkA.net

SIP HEADERS

Contact <sip:PoC-ServerX@networkX.net >

Event: conference

Content-Type: application/conference-info+xml

Subscription-State: active;expires=3600

XML MIME BODY

```

<?xml version="1.0" encoding="UTF-8"?>

  <conference-info xmlns="urn:ietf:params:xml:ns:conference-info"
    xmlns:xsi="http://www.w3.org/2001/XMLSchema-instance"
    xmlns:piind="urn:oma:xml:poc:participant-info-ind"
    xsi:schemaLocation="urn:ietf:params:xml:ns:conference-info"
    entity="sip:OMA-Golf-buddies@networkX.net" state="partial"
    version="1">
    <users>
      <user entity="sip:PoC-UserC@networkC.net" state="full">
        <display-text>PoC User C</display-text>
        <endpoint entity="sip:PoC-ClientC@networkC.net"
          piind:LocalQoE="Premium">
          <status>disconnected</status>
        </endpoint>
      </user>
    </users>
  </conference-info>

```

26. SIP NOTIFY request (from PoC Server A to SIP/IP Core A)

The PoC Server A forwards the SIP NOTIFY request to the SIP/IP Core A.

Request-URI sip:PoC-ClientA@networkA.net

SIP HEADERS

Contact <sip:PoC-ServerA@networkA.net >

Event: conference

Content-Type: application/conference-info+xml

Subscription-State: active;expires=3600

XML MIME BODY

```

<?xml version="1.0" encoding="UTF-8"?>

```

```

<conference-info xmlns="urn:ietf:params:xml:ns:conference-info"
  xmlns:xsi="http://www.w3.org/2001/XMLSchema-instance"
  xmlns:piind="urn:oma:xml:poc:participant-info-ind"
  xsi:schemaLocation="urn:ietf:params:xml:ns:conference-info"
  entity="sip:OMA-Golf-buddies@networkX.net" state="partial"
  version="1">
<users>
<user entity="sip:PoC-UserC@networkC.net" state="full">
  <display-text>PoC User C</display-text>
  <endpoint entity="sip:PoC-ClientC@networkC.net"
  piind:LocalQoE="Premium">
<status>disconnected</status>
  </endpoint>
</user>
</users>
</conference-info>

```

27. SIP NOTIFY request (from SIP/IP Core A to PoC Client A)

The SIP/IP Core A forwards the SIP NOTIFY request to the PoC Client A.

Request-URI sip:PoC-ClientA@networkA.net

SIP HEADERS

Contact <sip:PoC-ServerA@networkA.net >

Event: conference

Content-Type: application/conference-info+xml

Subscription-State: active;expires=3600

XML MIME BODY

```

<?xml version="1.0" encoding="UTF-8"?>

<conference-info xmlns="urn:ietf:params:xml:ns:conference-info"

```

```

xmlns:xsi="http://www.w3.org/2001/XMLSchema-instance"
xmlns:piind="urn:oma:xml:poc:participant-info-ind"
xsi:schemaLocation="urn:ietf:params:xml:ns:conference-info"
entity="sip:OMA-Golf-buddies@networkX.net" state="partial"
version="1">
<users>
<user entity="sip:PoC-UserC@networkC.net" state="full">
<display-text>PoC User C</display-text>
<endpoint entity="sip:PoC-ClientC@networkC.net"
piind:LocalQoE="Premium">
<status>disconnected</status>
</endpoint>
</user>
</users>
</conference-info>

```

28. SIP 200 "OK" response (from PoC Client A to SIP/IP Core A)

The PoC Client A sends the SIP 200 "OK" response to the SIP NOTIFY request to the SIP/IP Core A.

29. SIP 200 "OK" response (from SIP/IP Core A to PoC Server A)

The SIP/IP Core A forwards the SIP 200 "OK" response to the PoC Server A.

30. SIP 200 "OK" response (from PoC Server A to SIP/IP Core A)

The PoC Server A forwards the SIP 200 "OK" response to the SIP/IP Core A.

31. SIP 200 "OK" response (from SIP/IP Core A to SIP/IP Core X)

The SIP/IP Core A forwards the SIP 200 "OK" response to the SIP/IP Core X.

32. SIP 200 "OK" response (from SIP/IP Core X to PoC Server X)

The SIP/IP Core X forwards the SIP 200 "OK" response to the PoC Server X.

F.14.2 Participating PoC Function subscribing to Participant Information

This subclause shows an example on how one PoC Server performing the Participating PoC Function subscribes to Participant Information during an ongoing PoC Session.

PoC User D requested anonymity at the PoC Session establishment.

The example is valid for all types of PoC Sessions but only valid if the PoC Server performing the Participating PoC Function is acting as a B2BUA.

QoE Profiles feature is used in this flow so the Local QoE Profile used by each Participant is sent in the Participant Information.

PoC Clients B and D support FDCFO, while PoC Client C does not support FDCFO.

Figure 25 "A PoC Server performing the Participating PoC Function subscribes to Participant Information" shows the flow for the scenario.

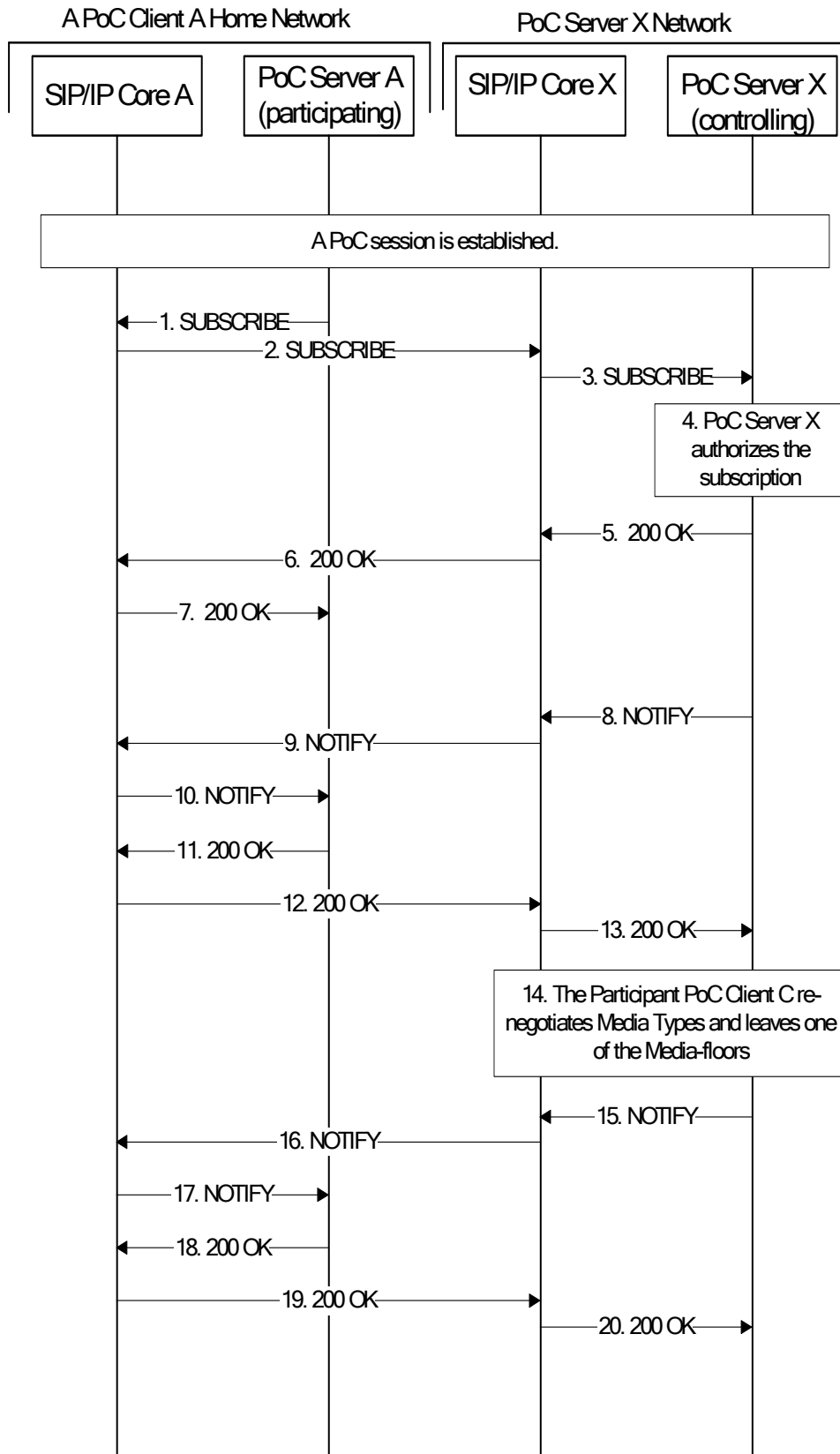

Figure 26: A PoC Server performing the Participating PoC Function subscribes to Participant Information.

The steps of the flows are as follows:

1. SIP SUBSCRIBE request (from PoC Server A to SIP/IP Core A)

The PoC Server A performing the Participating PoC Function need information about Participants in the PoC Session and sends a SIP SUBSCRIBE request to the SIP/IP Core A.

Request-URI <sip:PoC-SessionABCDEF@PoC-ServerX.networkX.net;session=prearranged>

SIP HEADERS

P-Asserted-Identity: <sip:PoC-ServerA@networkA.net>

User-Agent: PoC-serv/OMA2.0

Accept-Contact: *,+g.poc.talkburst; require;explicit

Contact: <sip:PoC-ServerA@networkA.net>

Event: conference

Target-Dialog Target-Dialog: fa77as7dad8-sd98ajzz@host.example.com
;local-tag=kkaz-
;remote-tag=6544

Expires: 3600

2. SIP SUBSCRIBE request (from SIP/IP Core A to SIP/IP Core X)

The SIP/IP Core A sends the SIP SUBSCRIBE request to the SIP/IP Core X based on the Request-URI.

Request-URI <sip:PoC-SessionABCDEF@PoC-ServerX.networkX.net;session=prearranged>

SIP HEADERS

P-Asserted-Identity: <sip:PoC-ServerA@networkA.net>

User-Agent: PoC-serv/OMA2.0

Accept-Contact: *,+g.poc.talkburst; require;explicit

Contact: <sip:PoC-ServerA@networkA.net>

Event: conference

Target-Dialog Target-Dialog: fa77as7dad8-sd98ajzz@host.example.com
;local-tag=kkaz-
;remote-tag=6544

Expires: 3600

3. SIP SUBSCRIBE request (from SIP/IP Core X to PoC Server X)

The SIP/IP Core X sends the SIP SUBSCRIBE request to the PoC Server X performing the Controlling PoC Function based on the PoC Group Identity in the Request-URI and the PoC feature tag '+g.poc.talkburst' in the Accept-Contact header.

Request-URI <sip:PoC-SessionABCDEF@PoC-ServerX.networkX.net;session=prearranged>

SIP HEADERS

P-Asserted-Identity: <sip:PoC-ServerA@networkA.net>

User-Agent: PoC-serv/OMA2.0

Accept-Contact: *,+g.poc.talkburst; require;explicit

Contact: <sip:PoC-ServerA@networkA.net>

Event: conference

Target-Dialog Target-Dialog: fa77as7dad8-sd98ajzz@host.example.com
;local-tag=kkaz-
;remote-tag=6544

Expires: 3600

4. The authorization (PoC Server X)

The PoC Server X authorizes the Participating PoC Function at the PoC Client A to receive Participant Information. The authorization is based on the content of the Target-Dialog.

5. SIP 200 "OK" response (from PoC Server X to SIP/IP Core X)

The authorization is successful and the PoC Server X (performing the Controlling PoC Function) sends the SIP 200 "OK" response to the SIP SUBSCRIBE request to SIP/IP Core X.

SIP HEADERS

P-Asserted-Identity: <sip:PoC-ServerX@networkX.net>

Server: PoC-serv/OMA2.0

6. SIP 200 "OK" response (from SIP/IP Core X to SIP/IP Core A)

The SIP/IP Core X forwards the SIP 200 "OK" response to the SIP/IP Core A.

SIP HEADERS

P-Asserted-Identity: <sip:PoC-ServerX@networkX.net>

Server: PoC-serv/OMA2.0

7. SIP 200 "OK" response (from SIP/IP Core A to PoC Server A)

The SIP/IP Core A forwards the SIP 200 "OK" response to the PoC Server A.

SIP HEADERS

P-Asserted-Identity: <sip:PoC-ServerX@networkX.net>
Server: PoC-serv/OMA2.0

8. SIP NOTIFY request (from PoC Server X to SIP/IP Core X)

The PoC Server X performing the Controlling PoC Function collects information about all Participants in the PoC Session and sends a complete list of all Participants (referred to as a "full" output in the conference state event package) in a SIP NOTIFY request to the SIP/IP Core X.

In the coding example below the PoC-UserD participates anonymous in the PoC Session. However, the PoC Server X performing the Controlling PoC Function includes the identity of PoC-UserD anyway since the PoC Server A is a trusted network element.

Request-URI sip:PoC-ServerA@networkA.net

SIP HEADERS

Contact <sip:PoC-ServerX@networkX.net >
Event: conference
Content-Type: application/conference-info+xml
Subscription-State: active;expires=3600

XML MIME BODY

```
<?xml version="1.0" encoding="UTF-8"?>

  <conference-info xmlns="urn:ietf:params:xml:ns:conference-info"
    xmlns:xsi="http://www.w3.org/2001/XMLSchema-instance"
    xmlns:piind="urn:oma:xml:poc:participant-info-ind"
    xsi:schemaLocation="urn:ietf:params:xml:ns:conference-info"
    entity="sip:OMA-Golf-buddies@networkX.net" state="full" version="1">

    <users>
      <user entity="sip:PoC-UserB@networkB.net" state="full">
        <display-text>PoC User B</display-text>
```

```
<endpoint entity="sip:PoC-ClientB@networkB.net" piind:LocalQoE="Basic"
piind:FDCFOSupported="true">
```

```
<status>connected</status>
```

```
<media id="1">
```

```
<type>audio</type>
```

```
<status>sendrecv</status>
```

```
</media>
```

```
<media id="2">
```

```
<type>video</type>
```

```
<status>sendrecv</status>
```

```
</media>
```

```
</endpoint>
```

```
</user>
```

```
<user entity="sip:PoC-UserC@networkC.net" state="full">
```

```
<display-text>PoC User C</display-text>
```

```
<endpoint entity="sip:PoC-ClientC@networkC.net"
piind:LocalQoE="Premium">
```

```
<status>connected</status>
```

```
<media id="1">
```

```
<type>audio</type>
```

```
<status>sendrecv</status>
```

```
</media>
```

```
</endpoint>
```

```
</user>
```

```
<user entity="sip:PoC-UserD@networkD.net" state="full" anonymous-
id="Batman@anonymous.invalid">
```

```
<display-text>anonymous-1</display-text>
```

```
<endpoint entity="sip:anonymous-1@anonymous.invalid"
piind:LocalQoE="Premium" piind:FDCFOSupported="true">
```

```
<status>connected</status>
```

```

<media id="1">

  <type>audio</type>

  <status>sendrecv</status>

</media>

<media id="2">

  <type>video</type>

  <status>sendrecv</status>

</media>

</endpoint>

</user>

</users>

</conference-info>

```

9. SIP NOTIFY request (from SIP/IP Core X to SIP/IP Core A)

The SIP/IP Core X forwards the SIP NOTIFY request to SIP/IP Core A.

Request-URI sip:PoC-ServerA@networkA.net

SIP HEADERS

Contact <sip:PoC-ServerX@networkX.net >

Event: conference

Content-Type: application/conference-info+xml

Subscription-State: active;expires=3600

XML MIME BODY

```

<?xml version="1.0" encoding="UTF-8"?>

  <conference-info xmlns="urn:ietf:params:xml:ns:conference-info"
    xmlns:xsi="http://www.w3.org/2001/XMLSchema-instance"

```

```
xmlns:piind="urn:oma:xml:poc:participant-info-ind"
xsi:schemaLocation="urn:ietf:params:xml:ns:conference-info"
entity="sip:OMA-Golf-buddies@networkX.net" state="full" version="1">

<users>
<user entity="sip:PoC-UserB@networkB.net" state="full">
<display-text>PoC User B</display-text>
<endpoint entity="sip:PoC-ClientB@networkB.net" piind:LocalQoE="Basic"
piind:FDCFOSupported="true">
<status>connected</status>
<media id="1">

    <type>audio</type>
    <status>sendrecv</status>
</media>

<media id="2">
    <type>video</type>
    <status>sendrecv</status>
</media>
</endpoint>
</user>

<user entity="sip:PoC-UserC@networkC.net" state="full">
<display-text>PoC User C</display-text>
<endpoint entity="sip:PoC-ClientC@networkC.net"
piind:LocalQoE="Premium">
<status>connected</status>
<media id="1">
    <type>audio</type>
    <status>sendrecv</status>
</media>
</endpoint>
```

```

</user>

<user entity="sip:PoC-UserD@networkD.net" state="full" anonymous-
id="Batman@anonymous.invalid">
<display-text>anonymous-1</display-text>
<endpoint entity="sip:anonymous-1@anonymous.invalid"
piind:LocalQoE="Premium" piind:FDCFOSupported="true">
<status>connected</status>

<media id="1">
  <type>audio</type>
  <status>sendrecv</status>
</media>

<media id="2">
  <type>video</type>
  <status>sendrecv</status>
</media>
</endpoint>
</user>
</users>
</conference-info>

```

10. SIP NOTIFY request (from SIP/IP Core A to PoC Server A)

The SIP/IP Core A forwards the SIP NOTIFY request to the PoC Server A.

Request-URI sip:PoC-ServerA@networkA.net

SIP HEADERS

Contact <sip:PoC-ServerX@networkX.net >

Event: conference

Content-Type: application/conference-info+xml

Subscription-State: active;expires=3600

XML MIME BODY

```
<?xml version="1.0" encoding="UTF-8"?>

  <conference-info xmlns="urn:ietf:params:xml:ns:conference-info"
    xmlns:xsi="http://www.w3.org/2001/XMLSchema-instance"
    xmlns:piind="urn:oma:xml:poc:participant-info-ind"
    xsi:schemaLocation="urn:ietf:params:xml:ns:conference-info"
    entity="sip:OMA-Golf-buddies@networkX.net" state="full" version="1">

    <users>

      <user entity="sip:PoC-UserB@networkB.net" state="full">
        <display-text>PoC User B</display-text>
        <endpoint entity="sip:PoC-ClientB@networkB.net" piind:LocalQoE="Basic"
          piind:FDCFOSupported="true">
          <status>connected</status>
          <media id="1">
            <type>audio</type>
            <status>sendrecv</status>
          </media>

          <media id="2">
            <type>video</type>
            <status>sendrecv</status>
          </media>
        </endpoint>
      </user>

      <user entity="sip:PoC-UserC@networkC.net" state="full">
        <display-text>PoC User C</display-text>
        <endpoint entity="sip:PoC-ClientC@networkC.net"
          piind:LocalQoE="Premium">
          <status>connected</status>
```

```
<media id="1">
  <type>audio</type>
  <status>sendrecv</status>
</media>
</endpoint>
</user>

<user entity="sip:PoC-UserD@networkD.net" state="full" anonymous-
id="Batman@anonymous.invalid">
  <display-text>anonymous-1</display-text>
  <endpoint entity="sip:anonymous-1@anonymous.invalid"
piind:LocalQoE="Premium" piind:FDCFOSupported="true">
  <status>connected</status>

  <media id="1">
    <type>audio</type>
    <status>sendrecv</status>
  </media>

  <media id="2">
    <type>video</type>
    <status>sendrecv</status>
  </media>
</endpoint>
</user>
</users>
</conference-info>
```

11. SIP 200 "OK" response (from PoC Server A to SIP/IP Core A)

The PoC Server A forwards the SIP 200 "OK" response to the SIP/IP Core A.

12. SIP 200 "OK" response (from SIP/IP Core A to SIP/IP Core X)

The SIP/IP Core A forwards the SIP 200 "OK" response to the SIP/IP Core X.

13. SIP 200 "OK" response (from SIP/IP Core X to PoC Server X)

The SIP/IP Core X forwards the SIP 200 "OK" response to the PoC Server X.

The following steps only happen if the subscription is active.

14. The Participant PoC Client C re-negotiates Media Types and leaves one of the Media-floors.

15. SIP NOTIFY request (from PoC Server X to SIP/IP Core X)

The PoC Server X performing the Controlling PoC Function sends a SIP NOTIFY request to the SIP/IP Core X. This time only information about the Participant leaving the Media-floor is sent (referred to by the conference state event package as a "partial" output).

Request-URI sip:PoC-ServerA@networkA.net

SIP HEADERS

Contact <sip:PoC-ServerX@networkX.net >

Event: conference

Content-Type: application/conference-info+xml

Subscription-State: active;expires=3600

XML MIME BODY

```
<?xml version="1.0" encoding="UTF-8"?>
```

```

<conference-info xmlns="urn:ietf:params:xml:ns:conference-info"
  xmlns:xsi="http://www.w3.org/2001/XMLSchema-instance"
  xmlns:piind="urn:oma:xml:poc:participant-info-ind"
  xsi:schemaLocation="urn:ietf:params:xml:ns:conference-info"
  entity="sip:OMA-Golf-buddies@networkX.net" state="partial"
  version="1">

```

```
<users state="partial">
```

```
<user entity="sip:PoC-UserC@networkC.net" state="full">
```

```
<display-text>PoC User C</display-text>
```

```
<endpoint entity="sip:PoC-ClientC@networkC.net"
  piind:LocalQoE="Premium">
```

```
<status>connected</status>
```

```
<media id="1">
```

```

    <type>audio</type>
    <status>sendrecv</status>
  </media>
  <media id="2">
    <type>video</type>
    <status>inactive</status>
  </media>
</endpoint>

</user>
</users>
</conference-info>

```

16. SIP NOTIFY request (from SIP/IP Core X to SIP/IP Core A)

The SIP/IP Core X forwards the SIP NOTIFY request to the SIP/IP Core A.

Request-URI sip:PoC-ServerA@networkA.net

SIP HEADERS

Contact <sip:PoC-ServerX@networkX.net >

Event: conference

Content-Type: application/conference-info+xml

Subscription-State: active;expires=3600

XML MIME BODY

```

<?xml version="1.0" encoding="UTF-8"?>

  <conference-info xmlns="urn:ietf:params:xml:ns:conference-info"
    xmlns:xsi="http://www.w3.org/2001/XMLSchema-instance"
    xmlns:piind="urn:oma:xml:poc:participant-info-ind"
    xsi:schemaLocation="urn:ietf:params:xml:ns:conference-info"
    entity="sip:OMA-Golf-buddies@networkX.net" state="partial"
    version="1">

```

```

<users>
  <user entity="sip:PoC-UserC@networkC.net" state="full">
    <display-text>PoC User C</display-text>
    <endpoint entity="sip:PoC-ClientC@networkC.net"
      piind:LocalQoE="Premium">
      <status>connected</status>

    <media id="1">

      <type>audio</type>

      <status>sendrecv</status>
    </media>
    <media id="2">
      <type>video</type>
      <status>inactive</status>
    </media>
  </endpoint>
</user>
</users>
</conference-info>

```

17. SIP NOTIFY request (from SIP/IP Core A to PoC Server A)

The SIP/IP Core A forwards the SIP NOTIFY request to the PoC Server A.

Request-URI sip:PoC-ServerA@networkA.net

SIP HEADERS

Contact <sip:PoC-ServerX@networkX.net >

Event: conference

Content-Type: application/conference-info+xml

Subscription-State: active;expires=3600

XML MIME BODY

```

<?xml version="1.0" encoding="UTF-8"?>

  <conference-info xmlns="urn:ietf:params:xml:ns:conference-info"
    xmlns:xsi="http://www.w3.org/2001/XMLSchema-instance"
    xmlns:piind="urn:oma:xml:poc:participant-info-ind"
    xsi:schemaLocation="urn:ietf:params:xml:ns:conference-info"
    entity="sip:OMA-Golf-buddies@networkX.net" state="partial"
    version="1">
    <users>
      <user entity="sip:PoC-UserC@networkC.net" state="full">
        <display-text>PoC User C</display-text>
        <endpoint entity="sip:PoC-ClientC@networkC.net"
          piind:LocalQoE="Premium">
          <status>connected</status>

          <media id="1">
            <type>audio</type>

            <status>sendrecv</status>
          </media>
          <media id="2">
            <type>video</type>
            <status>inactive</status>
          </media>
        </endpoint>
      </user>
    </users>
  </conference-info>

```

18. SIP 200 "OK" response (from PoC Server A to SIP/IP Core A)

The PoC Server A forwards the SIP 200 "OK" response to the SIP/IP Core A.

19. SIP 200 "OK" response (from SIP/IP Core A to SIP/IP Core X)

The SIP/IP Core A forwards the SIP 200 "OK" response to the SIP/IP Core X.

20. SIP 200 "OK" response (from SIP/IP Core X to PoC Server X)

The SIP/IP Core X forwards the SIP 200 "OK" response to the PoC Server X.

F.15 Group Advertisement

This subclause shows an example of how one PoC User can send a Group Advertisement to PoC Group. The example includes authorization and Access Control. The example also includes sending of text content, a reference to media content and media content included in MIME body.

F.15.1 Originating flow

This subclause describes the message flow between the sender of the Group Advertisement, i.e. the PoC Client A and the PoC Server A in the PoC Client A Home Network.

In this example the PoC Server A acts as proxy according to [RFC3261] and is not allowed to change the value of the headers User-Agent and Server, as specified in [RFC3428].

The flow is as shown in Figure 27 "*PoC Client A sends Group Advertisement to a PoC Group*".

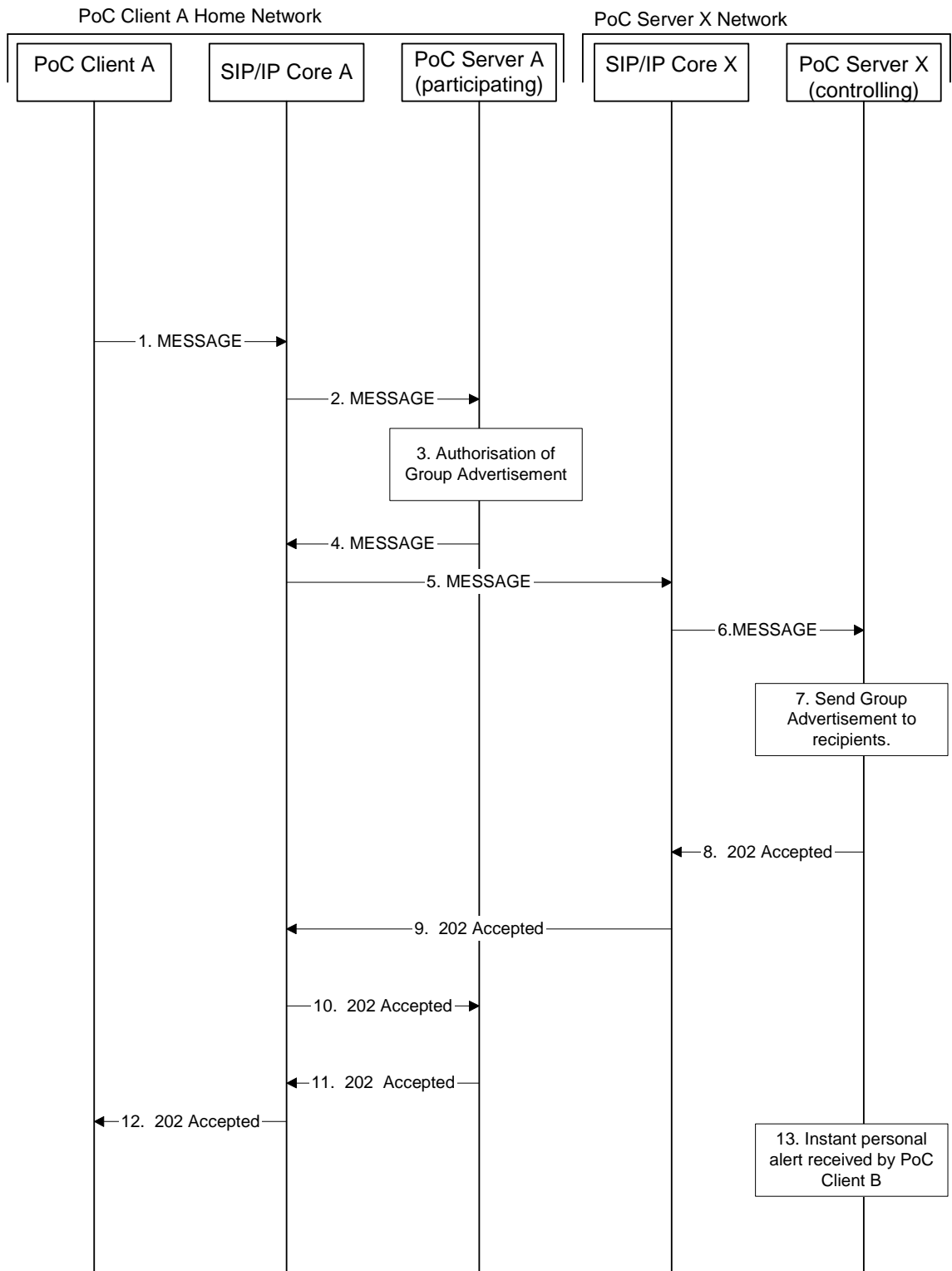

Figure 27: PoC Client A sends a Group Advertisement to a PoC Group

The steps of the flows are as follows:

1. SIP MESSAGE request (from PoC Client A to SIP/IP Core A)

The PoC Client A sends a SIP MESSAGE request to SIP/IP Core A. The Request-URI includes the PoC Group Address. The Accept-Contact header includes the PoC feature tag '+g.poc.groupad'.

Request-URI sip:OMA-Golf-buddies@networkX.net

SIP HEADERS

P-Preferred-Identity: "PoC User A" <sip:PoC-UserA@networkA.net>

Accept-Contact: *;+g.poc.groupad; require;explicit

User-Agent: PoC-client/OMA2.0 Acme-Talk5000/v1.01

Content-Type: multipart/mixed

Subject: A message from Your travel guide!

Call-Info: <http://publicweb.networkB.net/users/PoC-UserA@networkA.net/myOwnPicture.jpg>;purpose=icon

XML MIME BODY

Content-Type: application/vnd.poc.group-advertisement+xml

```
<?xml version="1.0" encoding="UTF-8"?>
```

```
<group-advertisement
```

```
  xmlns="urn:oma:xml:poc:group-advertisement"
```

```
  xmlns:xsi="http://www.w3.org/2001/XMLSchema-instance"
```

```
  xsi:schemaLocation="urn:oma:xml:poc:group-advertisement">
```

```
  <note>I set this group up for us golfers</note>
```

```
  <group type="dialed-in">
```

```
    <display-name>Golf Buddies</display-name>
```

```
    <uri>sip:OMA-Golf-buddies@networkX.net </uri>
```

```
    <supported-services>
```

```
      <service enabler="poc">
```

```
        <group-media>
```

```
          <poc-speech>
```

```
        </group-media>
```

```

        </service>

        </supported-services>

    </group>
</group-advertisement>

```

Included Media Content

Content-Type: text/directory;profile="vcard";charset=UTF-8

```

begin:vcard
fn:Tom Howard
n:Howard;Tom
org:Albatross Tours
EMAIL:TYPE=internet:POC-UserB@networkA.net
version:3.0
end:vcard

```

2. SIP MESSAGE request (from SIP/IP Core A to PoC Server A)

The SIP/IP Core A forwards the SIP MESSAGE request to the PoC Server A based on the PoC feature tag '+g.poc.groupad' in the Accept-Contact header.

Request-URI sip:OMA-Golf-buddies@networkX.net

SIP HEADERS

P-Asserted-Identity: "PoC User A" <sip:PoC-UserA@networkA.net>

Accept-Contact: *,+g.poc.groupad; require;explicit

User-Agent: PoC-client/OMA2.0 Acme-Talk5000/v1.01

Content-Type: multipart/mixed

Subject: A message from Your travel guide!

Call-Info: <http://publicweb.networkB.net/users/PoC-UserA@networkA.net/myOwnPicture.jpg>;purpose=icon

XML MIME BODY

Content-Type: application/vnd.poc.group-advertisement+xml

```
<?xml version="1.0" encoding="UTF-8"?>

<group-advertisement
  xmlns="urn:oma:xml:poc:group-advertisement"
  xmlns:xsi="http://www.w3.org/2001/XMLSchema-instance"
  xsi:schemaLocation="urn:oma:xml:poc:group-advertisement">

  <note>I set this group up for us golfers</note>
  <group type="dialed-in">
    <display-name>Golf Buddies</display-name>
    <uri>sip:OMA-Golf-buddies@networkX.net </uri>
    <supported-services>
      <service enabler="poc">
        <group-media>
          <poc-speech>
            </group-media>
          </service>
        </supported-services>
      </group>
    </group-advertisement>
```

Included Media Content

Content-Type: text/directory;profile="vcard";charset=UTF-8

```
begin:vcard
fn:Tom Howard
n:Howard;Tom
org:Albatross Tours
EMAIL:TYPE=internet:POC-UserB@networkA.net
version:3.0
end:vcard
```

3. The authorization (PoC Server A)

The PoC Server A authorizes the PoC User A at the PoC Client A to send a Group Advertisement.

4. MESSAGE request (from PoC Server A to SIP/IP Core A)

The PoC Server A forwards the SIP MESSAGE request to SIP/IP Core A.

Request-URI sip:OMA-Golf-buddies@networkX.net

SIP HEADERS

P-Asserted-Identity: "PoC User A" <sip:PoC-UserA@networkA.net>

Accept-Contact: *,+g.poc.groupad; require;explicit

User-Agent: PoC-client/OMA2.0 Acme-Talk5000/v1.01

Content-Type: multipart/mixed

Subject: A message from Your travel guide!

Call-Info: <http://publicweb.networkB.net/users/PoC-UserA@networkA.net/myOwnPicture.jpg>;purpose=icon

XML MIME BODY

Content-Type: application/vnd.poc.group-advertisement+xml

```
<?xml version="1.0" encoding="UTF-8"?>
```

```
<group-advertisement
```

```
  xmlns="urn:oma:xml:poc:group-advertisement"
```

```
  xmlns:xsi="http://www.w3.org/2001/XMLSchema-instance"
```

```
  xsi:schemaLocation="urn:oma:xml:poc:group-advertisement">
```

```
  <note>I set this group up for us golfers</note>
```

```
  <group type="dialed-in">
```

```
    <display-name>Golf Buddies</display-name>
```

```
    <uri>sip:OMA-Golf-buddies@networkX.net </uri>
```

```
    <supported-services>
```

```
      <service enabler="poc">
```

```
        <group-media>
```

```

        <poc-speech>
    </group-media>
</service>
</supported-services>
</group>
</group-advertisement>

```

Included Media Content

Content-Type: text/directory;profile="vcard";charset=UTF-8

```

begin:vcard
fn:Tom Howard
n:Howard;Tom
org:Albatross Tours
EMAIL:TYPE=internet:POC-UserB@networkA.net
version:3.0
end:vcard

```

5. SIP MESSAGE request (from SIP/IP Core A to SIP/IP Core X)

The SIP/IP Core A forwards the SIP MESSAGE request to the SIP/IP Core X.

Request-URI sip:OMA-Golf-buddies@networkX.net

SIP HEADERS

P-Asserted-Identity: "PoC User A" <sip:PoC-UserA@networkA.net>

Accept-Contact: *,+g.poc.groupad; require;explicit

User-Agent: PoC-client/OMA2.0 Acme-Talk5000/v1.01

Content-Type: multipart/mixed

Subject: A message from Your travel guide!

Call-Info: <http://publicweb.networkB.net/users/PoC-UserA@networkA.net/myOwnPicture.jpg>;purpose=icon

XML MIME BODY

Content-Type: application/vnd.poc.group-advertisement+xml

```
<?xml version="1.0" encoding="UTF-8"?>

<group-advertisement
  xmlns="urn:oma:xml:poc:group-advertisement"
  xmlns:xsi="http://www.w3.org/2001/XMLSchema-instance"
  xsi:schemaLocation="urn:oma:xml:poc:group-advertisement">

  <note>I set this group up for us golfers</note>
  <group type="dialed-in">
    <display-name>Golf Buddies</display-name>
    <uri>sip:OMA-Golf-buddies@networkX.net </uri>
    <supported-services>
      <service enabler="poc">
        <group-media>
          <poc-speech>
            </group-media>
          </service>
        </supported-services>
      </group>
    </group-advertisement>
```

Included Media Content

Content-Type: text/directory;profile="vcard";charset=UTF-8

```
begin:vcard
fn:Tom Howard
n:Howard;Tom
org:Albatross Tours
EMAIL:TYPE=internet:POC-UserB@networkA.net
version:3.0
end:vcard
```

6. SIP MESSAGE request (from SIP/IP Core X to PoC Server X)

The SIP/IP Core X forwards the SIP MESSAGE request to the PoC Server X.

Request-URI sip:OMA-Golf-buddies@networkX.net

SIP HEADERS

P-Asserted-Identity: "PoC User A" <sip:PoC-UserA@networkA.net>

Accept-Contact: *,+g.poc.groupad; require;explicit

User-Agent: PoC-client/OMA2.0 Acme-Talk5000/v1.01

Content-Type: multipart/mixed

Subject: A message from Your travel guide!

Call-Info: <http://publicweb.networkB.net/users/PoC-UserA@networkA.net/myOwnPicture.jpg>;purpose=icon

XML MIME BODY

Content-Type: application/vnd.poc.group-advertisement+xml

```
<?xml version="1.0" encoding="UTF-8"?>
```

```
<group-advertisement
```

```
  xmlns="urn:oma:xml:poc:group-advertisement"
```

```
  xmlns:xsi="http://www.w3.org/2001/XMLSchema-instance"
```

```
  xsi:schemaLocation="urn:oma:xml:poc:group-advertisement">
```

```
  <note>I set this group up for us golfers</note>
```

```
  <group type="dialed-in">
```

```
    <display-name>Golf Buddies</display-name>
```

```
    <uri>sip:OMA-Golf-buddies@networkX.net </uri>
```

```
    <supported-services>
```

```
      <service enabler="poc">
```

```
        <group-media>
```

```
          <poc-speech>
```

```
        </group-media>
```

```

        </service>
    </supported-services>
</group>
</group-advertisement>

```

Included Media Content

Content-Type: text/directory;profile="vcard";charset=UTF-8

```

begin:vcard
fn:Tom Howard
n:Howard;Tom
org:Albatross Tours
EMAIL:TYPE=internet:POC-UserB@networkA.net
version:3.0
end:vcard

```

7. The sending of the Group Advertisement (PoC Server X)

The PoC Server X initiates the sending of the Group Advertisement to the recipients including PoC Client B as described in subclause F.15.2 "*Terminating flow*".

8. SIP 202 "Accepted" response (from PoC Server X to SIP/IP Core X)

A SIP 202 "Accepted" response is sent by PoC Server X to SIP/IP Core X.

SIP HEADERS

P-Asserted-Identity: <sip:PoC-ServerX@networkX.net>
Server: PoC-serv/OMA2.0

9. SIP 202 "Accepted" response (from SIP/IP Core X to SIP/IP Core A)

SIP/IP Core X forwards the SIP 202 "Accepted" response to SIP/IP Core A.

SIP HEADERS

P-Asserted-Identity: <sip:PoC-ServerX@networkX.net>
Server: PoC-serv/OMA2.0

10. SIP 202 "Accepted" response (from SIP/IP Core A to PoC Server A)

SIP/IP Core A forwards the SIP 202 "Accepted" response to PoC Server A.

SIP HEADERS

P-Asserted-Identity: <sip:PoC-ServerX@networkX.net>

Server: PoC-serv/OMA2.0

11. SIP 202 "Accepted" response (from PoC Server A to SIP/IP Core A)

PoC Server A forwards the SIP 202 "Accepted" response to SIP/IP Core A.

SIP HEADERS

P-Asserted-Identity: <sip:PoC-ServerX@networkX.net>

Server: PoC-serv/OMA2.0

12. SIP 202 "Accepted" response (from SIP/IP Core A to PoC Client A)

SIP/IP Core A forwards the SIP 202 "Accepted" response to PoC Client A.

SIP HEADERS

P-Asserted-Identity: <sip:PoC-ServerX@networkX.net>

Server: PoC-serv/OMA2.0

13. The receipt of an acknowledgment (from PoC Client B Network to PoC Server X)

The PoC Server X receives an acknowledgment from the PoC Client B Network that the PoC Client B has received the Group Advertisement.

F.15.2 Terminating flow

This subclause describes the message flow between the receiver of the Group Advertisement, i.e. the PoC Client B and the PoC Server B in the PoC Client B Home Network.

In this example the PoC Server B acts as proxy according to [RFC3261] and is not allowed to change the value of the headers User-Agent and Server, as specified in [RFC3428].

The flow is as shown in Figure 28 "*PoC Client B receives a Group Advertisement from PoC Client A*".

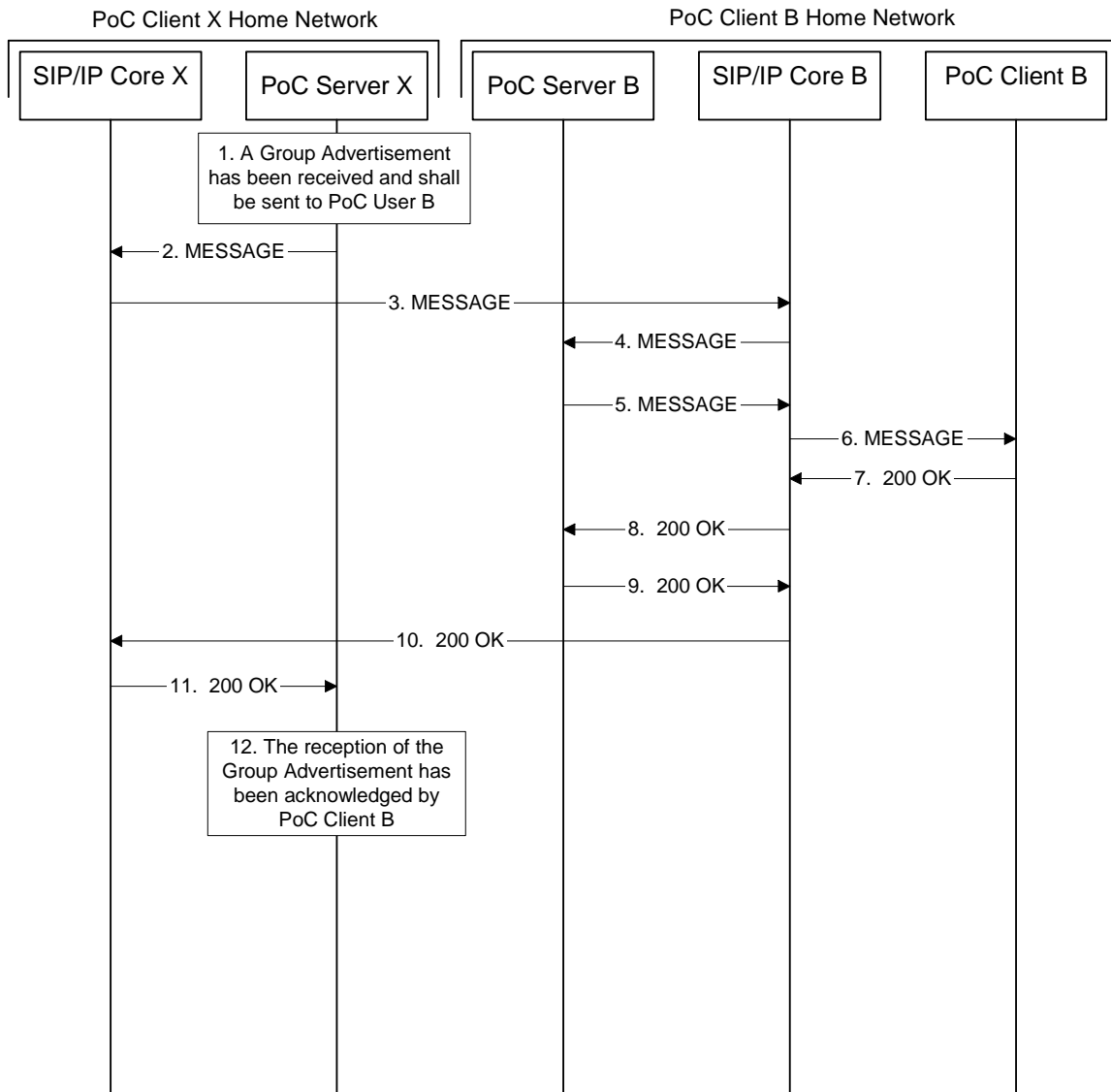

Figure 28: PoC Client B receives a Group Advertisement from PoC Client A

The steps of the flows are as follows:

1. The receipt of a Group Advertisement (PoC Server X)

The PoC Server X receives an authorized request from a PoC User A to send a Group Advertisement to a PoC Group that includes PoC User B.

2. SIP MESSAGE request (from PoC Server X to SIP/IP Core X)

The PoC Server X sends a SIP MESSAGE request to the SIP/IP Core X. The Request-URI includes the PoC Address of the PoC User B and an Accept-Contact header with the PoC feature tag '+g.poc.groupad'.

Request-URI sip:PoC-UserB@networkB.net

SIP HEADERS

P-Asserted-Identity: "PoC User A" <sip:PoC-UserA@networkA.net>
Accept-Contact: *,+g.poc.groupad; require;explicit
User-Agent: PoC-serv/OMA2.0
Content-Type: multipart/mixed
Subject: A message from Your travel guide!
Call-Info: <http://publicweb.networkB.net/users/PoC-UserA@networkA.net/myOwnPicture.jpg>;purpose=icon

XML MIME BODY

Content-Type: application/vnd.poc.group-advertisement+xml
<?xml version="1.0" encoding="UTF-8"?>

<group-advertisement
 xmlns="urn:oma:xml:poc:group-advertisement"
 xmlns:xsi="http://www.w3.org/2001/XMLSchema-instance"
 xsi:schemaLocation="urn:oma:xml:poc:group-advertisement">

 <note>I set this group up for us golfers</note>
 <group type="dialed-in">
 <display-name>Golf Buddies</display-name>
 <uri>sip:OMA-Golf-buddies@networkX.net </uri>
 <supported-services>
 <service enabler="poc">
 <group-media>
 <poc-speech>
 </poc-speech>
 </group-media>
 </service>
 </supported-services>
 </group>
</group-advertisement>

Included Media Content

Content-Type: text/directory;profile="vcard";charset=UTF-8

```

begin:vcard
fn:Tom Howard
n:Howard;Tom
org:Albatross Tours
EMAIL:TYPE=internet:POC-UserB@networkA.net
version:3.0
end:vcard

```

3. SIP MESSAGE request (from SIP/IP Core X to SIP/IP Core B)

The SIP/IP Core X sends the SIP MESSAGE request to the SIP/IP Core B based on the PoC Address of the PoC User B.

Request-URI sip:PoC-UserB@networkB.net

SIP HEADERS

P-Asserted-Identity: "PoC User A" <sip:PoC-UserA@networkA.net>
Accept-Contact: *;+g.poc.groupad; require;explicit
User-Agent: PoC-serv/OMA2.0
Content-Type: multipart/mixed
Subject: A message from Your travel guide!
Call-Info: <http://publicweb.networkB.net/users/PoC-UserA@networkA.net/myOwnPicture.jpg>;purpose=icon

XML MIME BODY

Content-Type: application/vnd.poc.group-advertisement+xml

```

<?xml version="1.0" encoding="UTF-8"?>

<group-advertisement
  xmlns="urn:oma:xml:poc:group-advertisement"
  xmlns:xsi="http://www.w3.org/2001/XMLSchema-instance"
  xsi:schemaLocation="urn:oma:xml:poc:group-advertisement">

```

```

<note>I set this group up for us golfers</note>
<group type="dialed-in">
  <display-name>Golf Buddies</display-name>
  <uri>sip:OMA-Golf-buddies@networkX.net </uri>
  <supported-services>
    <service enabler="poc">
      <group-media>
        <poc-speech>
          </group-media>
        </service>
      </supported-services>
    </group>
  </group-advertisement>

```

Included Media Content

Content-Type: text/directory;profile="vcard";charset=UTF-8

```

begin:vcard
fn:Tom Howard
n:Howard;Tom
org:Albatross Tours
EMAIL:TYPE=internet:POC-UserB@networkA.net
version:3.0
end:vcard

```

4. SIP MESSAGE request (from SIP/IP Core B to PoC Server B)

The SIP/IP Core B sends the SIP MESSAGE request to the PoC Server B based on the PoC feature tag '+g.poc.groupad' in the Accept Contact.

Request-URI sip:PoC-UserB@networkB.net

SIP HEADERS

P-Asserted-Identity: "PoC User A" <sip:PoC-UserA@networkA.net>
Accept-Contact: *,+g.poc.groupad; require;explicit
User-Agent: PoC-serv/OMA2.0
Content-Type: multipart/mixed
Subject: A message from Your travel guide!
Call-Info: <http://publicweb.networkB.net/users/PoC-UserA@networkA.net/myOwnPicture.jpg>;purpose=icon

XML MIME BODY

Content-Type: application/vnd.poc.group-advertisement+xml
 <?xml version="1.0" encoding="UTF-8"?>

```

<group-advertisement
  xmlns="urn:oma:xml:poc:group-advertisement"
  xmlns:xsi="http://www.w3.org/2001/XMLSchema-instance"
  xsi:schemaLocation="urn:oma:xml:poc:group-advertisement">

  <note>I set this group up for us golfers</note>
  <group type="dialed-in">
    <display-name>Golf Buddies</display-name>
    <uri>sip:OMA-Golf-buddies@networkX.net </uri>
    <supported-services>
      <service enabler="poc">
        <group-media>
          <poc-speech>
        </group-media>
      </service>
    </supported-services>
  </group>
</group-advertisement>
  
```

Included Media Content

Content-Type: text/directory;profile="vcard";charset=UTF-8

```

begin:vcard
fn:Tom Howard
n:Howard;Tom
org:Albatross Tours
EMAIL:TYPE=internet:POC-UserB@networkA.net
version:3.0
end:vcard

```

5. SIP MESSAGE request (from PoC Server B to SIP/IP Core B)

The PoC Server B performs Access Control and determines that the PoC User A at the PoC Client A is authorized to send a Group Advertisement to the PoC User B. The PoC Server B sends the SIP MESSAGE request to the SIP/IP Core.

Request-URI sip:PoC-UserB@networkB.net

SIP HEADERS

P-Asserted-Identity: "PoC User A" <sip:PoC-UserA@networkA.net>
Accept-Contact: *,+g.poc.groupad; require;explicit
User-Agent: PoC-serv/OMA2.0
Content-Type: multipart/mixed
Subject: A message from Your travel guide!
Call-Info: <http://publicweb.networkB.net/users/PoC-UserA@networkA.net/myOwnPicture.jpg>;purpose=icon

XML MIME BODY

Content-Type: application/vnd.poc.group-advertisement+xml

```

<?xml version="1.0" encoding="UTF-8"?>

<group-advertisement
  xmlns="urn:oma:xml:poc:group-advertisement"
  xmlns:xsi="http://www.w3.org/2001/XMLSchema-instance"
  xsi:schemaLocation="urn:oma:xml:poc:group-advertisement">

```

```

<note>I set this group up for us golfers</note>
<group type="dialed-in">
  <display-name>Golf Buddies</display-name>
  <uri>sip:OMA-Golf-buddies@networkX.net </uri>
  <supported-services>
    <service enabler="poc">
      <group-media>
        <poc-speech>
          </group-media>
        </service>
      </supported-services>
    </group>
  </group-advertisement>

```

Included Media Content

Content-Type: text/directory;profile="vcard";charset=UTF-8

```

begin:vcard
fn:Tom Howard
n:Howard;Tom
org:Albatross Tours
EMAIL:TYPE=internet:POC-UserB@networkA.net
version:3.0
end:vcard

```

6. SIP MESSAGE request (from SIP/IP Core B to PoC Client B)

The SIP IP/Core B sends the SIP MESSAGE to the PoC Client B based on information stored during registration.

Request-URI sip:PoC-UserB@networkB.net

SIP HEADERS

P-Asserted-Identity: "PoC User A" <sip:PoC-UserA@networkA.net>
Accept-Contact: *,+g.poc.groupad; require;explicit
User-Agent: PoC-serv/OMA2.0
Content-Type: multipart/mixed
Subject: A message from Your travel guide!
Call-Info: <http://publicweb.networkB.net/users/PoC-UserA@networkA.net/myOwnPicture.jpg>;purpose=icon

XML MIME BODY

Content-Type: application/vnd.poc.group-advertisement+xml
 <?xml version="1.0" encoding="UTF-8"?>

```

<group-advertisement
  xmlns="urn:oma:xml:poc:group-advertisement"
  xmlns:xsi="http://www.w3.org/2001/XMLSchema-instance"
  xsi:schemaLocation="urn:oma:xml:poc:group-advertisement">

  <note>I set this group up for us golfers</note>
  <group type="dialed-in">
    <display-name>Golf Buddies</display-name>
    <uri>sip:OMA-Golf-buddies@networkX.net </uri>
    <supported-services>
      <service enabler="poc">
        <group-media>
          <poc-speech>
        </group-media>
      </service>
    </supported-services>
  </group>
</group-advertisement>
  
```

Included Media Content

Content-Type: text/directory;profile="vcard";charset=UTF-8

```
begin:vcard
fn:Tom Howard
n:Howard;Tom
org:Albatross Tours
EMAIL:TYPE=internet:POC-UserB@networkA.net
version:3.0
end:vcard
```

7. SIP 200 "OK" response (from PoC Client B to SIP/IP Core B)

The PoC Client B sends a SIP 200 "OK" response to the SIP/IP Core B in order to acknowledge that the Group Advertisement was received. The SIP 200 "OK" response is sent along the signalling path to the PoC Server A.

SIP HEADERS

Server: PoC-client/OMA2.0 Acme-Talk5000/v1.01

8. SIP 200 "OK" response (from SIP/IP Core B to PoC Server B)

The SIP/IP Core B forwards the SIP 200 "OK" response to PoC Server B.

SIP HEADERS

P-Asserted-Identity: "PoC User B" <sip:PoC-ClientB@networkB.net>

Server: PoC-client/OMA2.0 Acme-Talk5000/v1.01

9. SIP 200 "OK" response (from PoC Server B to SIP/IP Core B)

The PoC Server B forwards the SIP 200 "OK" response to SIP/IP Core B.

SIP HEADERS

P-Asserted-Identity: "PoC User B" <sip:PoC-ClientB@networkB.net>

Server: PoC-client/OMA2.0 Acme-Talk5000/v1.010

10. SIP 200 "OK" response (from SIP/IP Core B to SIP/IP Core X)

The SIP/IP Core B forwards the SIP 200 "OK" response SIP/IP Core X.

SIP HEADERS

P-Asserted-Identity: "PoC User B" <sip:PoC-ClientB@networkB.net>
Server: PoC-client/OMA2.0 Acme-Talk5000/v1.01

11. SIP 200 "OK" response (from SIP/IP Core to PoC Server X)

The SIP/IP Core X forwards the SIP 200 "OK" response to PoC Server X.

SIP HEADERS

P-Asserted-Identity: "PoC User B" <sip:PoC-ClientB@networkB.net>
Server: PoC-client/OMA2.0 Acme-Talk5000/v1.01

12. The sending of the acknowledgement (PoC Server X to PoC Client A)

The PoC Server X sends the acknowledgment to the PoC Client A as shown in Figure 27 "*PoC Client A sends a Group Advertisement to a PoC Group*".

F.16 Dispatch PoC Session establishment

F.16.1 Originating flow – Invite the whole group – unconfirmed case

The signalling sequences in this subclause show the establishment of the Dispatch PoC Session using on-demand signalling in the originating side. As a prerequisite for the on-demand signalling, PoC Client needs to be registered.

This flow shows the signalling sequence for the case of inviting the whole Dispatch PoC Group. If a subset of the Dispatch PoC Group is invited, the Dispatch Type uri-parameter is set to "dispatch=sub-group" and a Content-Type header with the value "multipart/mixed" and a MIME resource-lists body with the PoC Address(es) of the Invited PoC User(s) are also included.

QoE Profiles feature is used in this flow, PoC Client A requests Professional QoE Profile and the QoE Profile defined for the Dispatch PoC Group is also Professional QoE Profile.

This flow shows the signalling sequence for the unconfirmed case. In this case a SIP 183 "Session Progress" response is received from the terminating side before a SIP 200 "OK" response is sent, PoC Server performing the Controlling PoC Function, sends a SIP 200 "OK" response to the PoC Client. In this flow the media buffering is supported and the TBCP Talk Burst Granted is sent after the SIP 183 "Session Progress" is received. If buffering is not supported the TBCP Talk Burst Granted is sent after the SIP 200 "OK" is received. The flow is as shown in Figure 29 "*Dispatch PoC Session establishment with the whole Dispatch PoC Group on the originating side using on-demand signalling, unconfirmed case*".

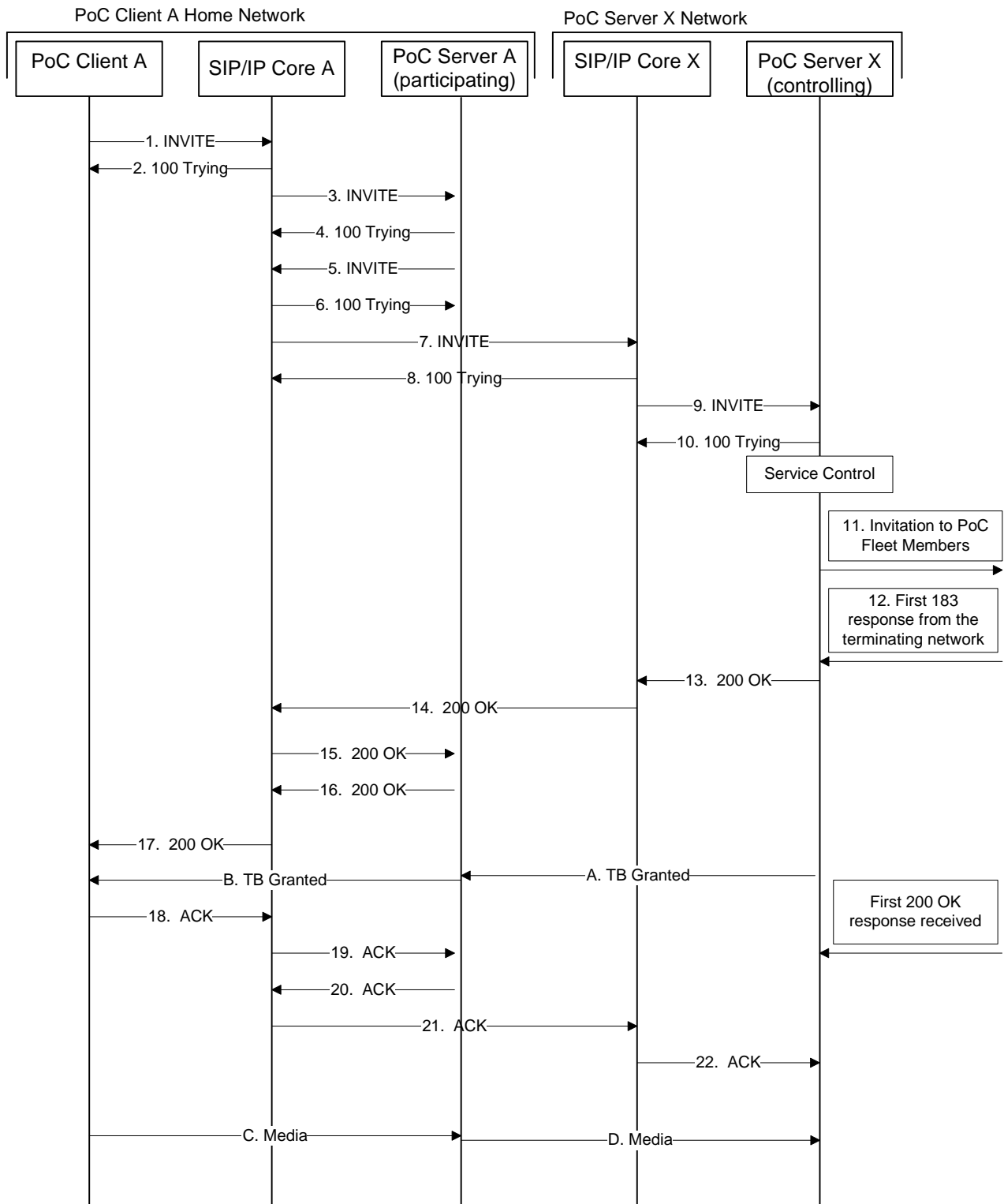

Figure 29: Dispatch PoC Session establishment with the whole Dispatch PoC Group on the originating side using on-demand signalling, unconfirmed case

The steps of the flows are as follows:

1. SIP INVITE request (from PoC Client A to SIP/IP Core A)

The PoC Client receives a request from the PoC User to establish a Dispatch PoC Session as PoC Dispatcher and sends a SIP INVITE request to the SIP/IP Core A. The SIP INVITE request includes the Dispatch PoC Group Identity in the Request-URI.

Request-URI <sip:OMA-Highway-Maintenance-Company@networkX.net;session=prearranged>; dispatch=entire-group;

SIP HEADERS

P-Preferred-Identity: "PoC User A" <sip:PoC-UserA@networkA.net>
Accept-Contact: *,+g.poc.talkburst; require;explicit
User-Agent: PoC-client/OMA2.0 Acme-Talk5000/v1.01
Contact: <sip:PoC-ClientA.networkA.net>;+sip.instance="<urn:uuid:00000000-0000-1000-8000-000A95A0E128>";+g.poc.talkburst; +g.poc.dispatcher;
Supported: timer
Session-Expires: 1800;refresher=uac
Allow: INVITE,ACK,CANCEL,BYE,REFER,MESSAGE,SUBSCRIBE,NOTIFY,PUBLISH,OPTIONS
Priv-Answer-Mode: Auto

SDP PARAMETERS

c= IN IP6 5555::aaa:bbb:ccc:ddd
a= poc-qoe:professional
m= audio 3456 RTP/AVP 97
a= rtpmap:97 AMR
a= rtcp:5560
a= label:1
m= video 4567 RTP/AVP 34
a= rtpmap:34 H263/90000
a= rtcp:5570
a= label:2
m= application 2000 udp TBCP
a= fmp: TBCP multimedia=1;queuing=1; tb_priority=2; timestamp=1
a= floorid:0 mstrm:1 2

2. SIP 100 "Trying" response (from SIP/IP Core A to PoC Client A)

The SIP/IP Core A sends a SIP 100 "Trying" response to the PoC Client A.

3. SIP INVITE request (from SIP/IP Core A to PoC Server A)

The SIP/IP Core A sends the SIP INVITE request to the PoC Server A.

Request-URI <sip:OMA-Highway-Maintenance-Company@networkX.net;session=prearranged>; dispatch=entire-group;

SIP HEADERS

P-Asserted-Identity: "PoC User A" <sip:PoC-UserA@networkA.net>
Accept-Contact: *,+g.poc.talkburst; require;explicit
User-Agent: PoC-client/OMA2.0 Acme-Talk5000/v1.01
Contact: <sip:PoC-ClientA.networkA.net>;+sip.instance="<urn:uuid:00000000-0000-1000-8000-000A95A0E128>";+g.poc.talkburst; +g.poc.dispatcher;
Supported: timer
Session-Expires: 1800;refresher=uac
Allow: INVITE,ACK,CANCEL,BYE,REFER,MESSAGE,SUBSCRIBE,NOTIFY,PUBLISH,OPTIONS
Priv-Answer-Mode: Auto

SDP PARAMETERS

c= IN IP6 5555::aaa:bbb:ccc:ddd
a= poc-qoe:professional
m= audio 3456 RTP/AVP 97
a= rtpmap:97 AMR
a= rtcp:5560
a= label:1
m= video 4567 RTP/AVP 34
a= rtpmap:34 H263/90000
a= rtcp:5570
a= label:2
m= application 2000 udp TBCP
a= fmp: TBCP multimedia=1; queuing=1; tb_priority=2; timestamp=1

a= floorid:0 mstrm:1 2

4. SIP 100 "Trying" response (from PoC Server A to SIP/IP Core A)

The PoC Server A sends a SIP 100 "Trying" response to the SIP/IP Core A.

5. SIP INVITE request (from PoC Server A to SIP/IP Core A)

Using the Dispatch PoC Group Identity the PoC Server A determines that the Dispatch PoC Group is owned by another PoC Server and sends the SIP INVITE request to the SIP/IP Core A. The SIP INVITE request includes the Dispatch PoC Group Identity in the Request-URI.

Request-URI <sip:OMA-Highway-Maintenance-Company@networkX.net;session=prearranged>; dispatch=entire-group;

SIP HEADERS

P-Asserted-Identity: "PoC User A" <sip:PoC-UserA@networkA.net>
Accept-Contact: *,+g.poc.talkburst; require;explicit
User-Agent: PoC-serv/OMA2.0
Contact: <sip:PoC-SessionABCDEF@PoC-ServerA.networkA.net>;+g.poc.talkburst;+g.poc.dispatcher;
Supported: timer
Session-Expires: 1800;refresher=uac
Allow: INVITE,ACK,CANCEL,BYE,REFER,MESSAGE,SUBSCRIBE,NOTIFY,PUBLISH,OPTIONS
Priv-Answer-Mode: Auto

SDP PARAMETERS

c= IN IP6 50555::ccc:ddd:aaa:bbb
a= poc-qoe:professional
m= audio 53456 RTP/AVP 97 98
a= rtpmap:97 AMR
a= rtpmap:98 EVRC/8000
a= rtcp:53080
a= label:1
m= video 54567 RTP/AVP 34
a= rtpmap:34 H263/90000

a= rtcp:53090
a= label:2
m= Application 50000 udp TBCP
a= fmp: TBCP multimedia=1; queuing=1; tb_priority=2; timestamp=1
a= floorid:0 mstrm:1 2

6. SIP 100 "Trying" response (from SIP/IP Core A to PoC Server A)

The SIP/IP Core A sends a SIP 100 "Trying" response to the PoC Server A.

7. SIP INVITE request (from SIP/IP Core A to SIP/IP Core X)

Based on the Dispatch PoC Group Identity in the Request-URI the SIP/IP Core A sends the SIP INVITE request to the SIP/IP Core X.

Request-URI <sip:OMA-Highway-Maintenance-Company@networkX.net;session=prearranged>; dispatch=entire-group;

SIP HEADERS

P-Asserted-Identity: "PoC User A" <sip:PoC-UserA@networkA.net>
Accept-Contact: *,+g.poc.talkburst; require;explicit
User-Agent: PoC-serv/OMA2.0
Contact: <sip:PoC-SessionABCDEF@PoC-ServerA.networkA.net>;+g.poc.talkburst;+g.poc.dispatcher;
Supported: timer
Session-Expires: 1800;refresher=uac
Allow: INVITE,ACK,CANCEL,BYE,REFER,MESSAGE,SUBSCRIBE,NOTIFY,PUBLISH,OPTIONS
Priv-Answer-Mode: Auto

SDP PARAMETERS

c= IN IP6 50555::ccc:ddd:aaa:bbb
a= poc-qoe:professional
m= audio 53456 RTP/AVP 97 98
a= rtpmap:97 AMR
a= rtpmap:98 EVRC/8000
a= rtcp:53080

a= label:1
m= video 54567 RTP/AVP 34
a= rtpmap:34 H263/90000
a= rtcp:53090
a= label:2
m= Application 50000 udp TBCP
a= fmp: TBCP multimedia=1; queuing=1; tb_priority=2; timestamp=1
a= floorid:0 mstrm:1 2

8. SIP 100 "Trying" response (from SIP/IP Core X to SIP/IP Core A)

The SIP/IP Core X sends a SIP 100 "Trying" response to the SIP/IP Core A.

9. SIP INVITE request (from SIP/IP Core X to PoC Server X)

The SIP/IP Core X sends the SIP INVITE request to the PoC Server X.

Request-URI <sip:OMA-Highway-Maintenance-Company@networkX.net;session=prearranged>; dispatch=entire-group;

SIP HEADERS

P-Asserted-Identity: "PoC User A" <sip:PoC-UserA@networkA.net>
Accept-Contact: *,+g.poc.talkburst; require;explicit
User-Agent: PoC-serv/OMA2.0
Contact: <sip:PoC-SessionABCDEF@PoC-ServerA.networkA.net>;+g.poc.talkburst;+g.poc.dispatcher;
Supported: timer
Session-Expires: 1800;refresher=uac
Allow: INVITE,ACK,CANCEL,BYE,REFER,MESSAGE,SUBSCRIBE,NOTIFY,PUBLISH,OPTIONS
Priv-Answer-Mode: Auto

SDP PARAMETERS

c= IN IP6 50555::ccc:ddd:aaa:bbb
a= poc-qoe:professional
m= audio 53456 RTP/AVP 97 98
a= rtpmap:97 AMR

```

a=                rtpmap:98 EVRC/8000
a=                rtcp:53080
a=                label:1
m=                video 54567 RTP/AVP 34
a=                rtpmap:34 H263/90000
a=                rtcp:53090
a=                label:2
m=                Application 50000 udp TBCP
a=                fmp: TBCP multimedia=1; queuing=1; tb_priority=2; timestamp=1
a=                floorid:0 mstrm:1 2

```

10. SIP 100 "Trying" response (from PoC Server X to SIP/IP Core X)

The PoC Server X sends the SIP 100 "Trying" response to the SIP/IP Core X.

11. PoC Server X sends SIP INVITE requests towards the Invited PoC Clients

The PoC Server A sends SIP INVITE requests to the Invited PoC Clients (Fleet Members) as shown in Figure 30 "*Dispatch PoC Session establishment on the terminating side with manual answer override*".

The QoE Profile defined for the Dispatch PoC Group is Professional.

Request-URI sip:PoC-UserB@networkB.net

SIP HEADERS

P-Asserted-Identity: <sip:OMA-Highway-Maintenance-Company@networkX.net;session=prearranged>; dispatch=entire-group;

Accept-Contact: *,+g.poc.talkburst; require;explicit

User-Agent: PoC-serv/OMA2.0

Referred-By: "PoC User A" <sip:PoC-UserA@networkA.net>

Contact: <sip:PoC-SessionABCDEF@PoC-ServerX.networkX.net;session=prearranged>;+g.poc.talkburst;isfocus; dispatch=entire-group

Supported: 100rel, norefersub, timer

Session-Expires: 1800

Allow: INVITE,ACK,CANCEL,BYE,PRACK,UPDATE,REFER,OPTIONS

Priv-Answer-Mode: Auto

SDP PARAMETERS

c= IN IP6 50555::ccc:ddd:aaa:bbb
a= poc-qoe:professional
m= audio 53456 RTP/AVP 97 98
a= rtpmap:97 AMR
a= rtpmap:98 EVRC/8000
a= rtcp:53080
a= label:1
m= video 54567 RTP/AVP 34
a= rtpmap:34 H263/90000
a= rtcp:53090
a= label:2
m= Application 50000 udp TBCP
a= fmp: TBCP multimedia=1; queuing=1; tb_priority=2; timestamp=1
a= floorid:0 mstrm:1 2

12. PoC Server X receives a SIP 183 "Session Progress" response

The PoC Server X receives the first SIP 183 "Session Progress" response as shown in Figure 30 "Dispatch PoC Session establishment on the terminating side with manual answer override".

SIP HEADERS

P-Asserted-Identity: "PoC User B" <sip:PoC-UserB@networkB.net>
Require: 100rel
Server: PoC-Serv/OMA2.0
Contact: <sip:PoC-SessionABCDEF@PoC-ServerB.networkB.net>;+g.poc.talkburst
P-Answer-State: Unconfirmed
Allow: INVITE,ACK,CANCEL,BYE, PRACK, UPDATE, REFER,OPTIONS

13. SIP 200 "OK" response (from PoC Server X to SIP/IP Core X)

The PoC Server X sends a SIP 200 "OK" to SIP/IP Core X. (Optionally PoC Server X inserts Talk Burst granted indication into the SIP 200 "OK" response).

SIP HEADERS

P-Asserted-Identity: <sip:OMA-Highway-Maintenance-

Company@networkX.net;session=prearranged>; dispatch=entire-group;

Contact <sip:PoC-SessionABCDEF@PoC-ServerX.networkX.net;session=chat>;+g.poc.talkburst;isfocus; dispatch=entire-group;

Server: PoC-serv/OMA2.0

Require: timer

Session-Expires: 1800;refresher=uac

Allow: INVITE,ACK,CANCEL,BYE,PRACK, UPDATE, REFER,MESSAGE,SUBSCRIBE, NOTIFY,PUBLISH,OPTIONS

P-Answer-State: Unconfirmed

SDP PARAMETERS

c= IN IP6 96666::eee: aaa:bbb:fff

a= poc-qoe:professional

m= audio 96525 RTP/AVP 98

a= rtpmap:98 EVRC/8000

a= rtcp:96000

a= label:1

m= video 96626 RTP/AVP 34

a= rtpmap:34 H263/90000

a= rtcp:96100

a= label:2

m= application 96000 udp TBCP

a= fmp: TBCP multimedia=1; queuing=1; tb_priority=2; timestamp=1

a= floorid:0 mstrm:1 2

14. SIP 200 "OK" response (from SIP/IP Core X to SIP/IP Core A)

The SIP/IP Core X sends the SIP 200 "OK" response to the SIP/IP Core A.

SIP HEADERS

P-Asserted-Identity: <sip:OMA-Highway-Maintenance-Company@networkX.net;session=prearranged>; dispatch=entire-group;

Contact <sip:PoC-SessionABCDEF@PoC-ServerX.networkX.net;session=chat>;+g.poc.talkburst;isfocus; dispatch=entire-group;

Server: PoC-serv/OMA2.0
Require: timer
Session-Expires: 1800;refresher=uac
Allow: INVITE,ACK,CANCEL,BYE,PRACK, UPDATE,
REFER,MESSAGE,SUBSCRIBE, NOTIFY,PUBLISH,OPTIONS
P-Answer-State: Unconfirmed
Supported: norefersub

SDP PARAMETERS

c= IN IP6 96666::eee: aaa:bbb:fff
a= poc-qoe:professional
m= audio 96525 RTP/AVP 98
a= rtpmap:98 EVRC/8000
a= rtcp:96000
a= label:1
m= video 96626 RTP/AVP 34
a= rtpmap:34 H263/90000
a= rtcp:96100
a= label:2
m= application 96000 udp TBCP
a= fmp: TBCP multimedia=1; queuing=1; tb_priority=2; timestamp=1
a= floorid:0 mstrm:1 2

15. SIP 200 "OK" response (from SIP/IP Core A to PoC Server A)

The SIP/IP Core A sends the SIP 200 "OK" response to the PoC Server A.

SIP HEADERS

P-Asserted-Identity: <sip:OMA-Highway-Maintenance-
Company@networkX.net;session=prearranged>; dispatch=entire-group;
Contact <sip:PoC-SessionABCDEF@PoC-ServerX.networkX.net;
session=prearranged>;+g.poc.talkburst;isfocus; dispatch=entire-group;
Server: PoC-serv/OMA2.0
Require: timer
Session-Expires: 1800;refresher=uac

Allow: INVITE,ACK,CANCEL,BYE,PRACK, UPDATE,
REFER,MESSAGE,SUBSCRIBE, NOTIFY,PUBLISH,OPTIONS

P-Answer-State: Unconfirmed

Supported: norefersub

SDP PARAMETERS

c= IN IP6 96666::eee: aaa:bbb:fff

a= poc-qoe:professional

m= audio 96525 RTP/AVP 98

a= rtpmap:98 EVRC/8000

a= rtcp:96000

a= label:1

m= video 96626 RTP/AVP 34

a= rtpmap:34 H263/90000

a= rtcp:96100

a= label:2

m= application 96000 udp TBCP

a= fmp: TBCP multimedia=1; queuing=1; tb_priority=2; timestamp=1

a= floorid:0 mstrm:1 2

16. SIP 200 "OK" response (from PoC Server A to SIP/IP Core A)

The PoC Server A sends the SIP 200 "OK" response to SIP/IP Core A.

SIP HEADERS

P-Asserted-Identity: <sip:OMA-Highway-Maintenance-
Company@networkX.net;session=prearranged>; dispatch=entire-group;

Contact <sip:PoC-SessionABCDEF@PoC-ServerA.networkA.net;
session=prearranged>;+g.poc.talkburst;isfocus; dispatch=entire-group;

Server: PoC-serv/OMA2.0

Require: timer

Session-Expires: 1800;refresher=uac

Allow: INVITE,ACK,CANCEL,BYE,PRACK, UPDATE,
REFER,MESSAGE,SUBSCRIBE, NOTIFY,PUBLISH,OPTIONS

Supported: norefersub

SDP PARAMETERS

c= IN IP6 57777::eee:fff:aaa:bbb
a= poc-qoe:professional
m= audio 57787 RTP/AVP 98
a= rtpmap:98 EVRC/8000
a= rtcp:57000
a= label:1
m= video 57898 RTP/AVP 34
a= rtpmap:34 H263/90000
a= rtcp:57100
a= label:2
m= application 57790 udp TBCP
a= fmp: TBCP multimedia=1; queuing=1; tb_priority=2; timestamp=1
a= floorid:0 mstrm:1 2

17. SIP 200 "OK" response (from SIP/IP Core A to PoC Client A)

The SIP/IP Core A sends the SIP 200 "OK" response to the PoC Client A.

SIP HEADERS

P-Asserted-Identity: <sip:OMA-Highway-Maintenance-Company@networkX.net;session=prearranged>; dispatch=entire-group;
Contact <sip:PoC-SessionABCDEF@PoC-ServerA.networkA.net;session=prearranged>;+g.poc.talkburst;isfocus; dispatch=entire-group;
Server: PoC-serv/OMA2.0
Require: timer
Session-Expires: 1800;refresher=uac
Allow: INVITE,ACK,CANCEL,BYE,PRACK, UPDATE, REFER,MESSAGE,SUBSCRIBE, NOTIFY,PUBLISH,OPTIONS
Supported: norefersub

SDP PARAMETERS

c= IN IP6 57777::eee:fff:aaa:bbb
a= poc-qoe:professional

```

m=          audio 57787 RTP/AVP 98
a=          rtpmap:98 EVRC/8000
a=          rtcp:57000
a=          label:1
m=          video 57898 RTP/AVP 34
a=          rtpmap:34 H263/90000
a=          rtcp:57100
a=          label:2
m=          application 57790 udp TBCP
a=          fmp: TBCP multimedia=1; queuing=1; tb_priority=2; timestamp=1
a=          floorid:0 mstrm:1 2

```

A. TBCP Talk Burst Granted (PoC Server X to PoC Server A)

The PoC Server X sends TBCP Talk Burst Granted message to PoC Server A. This step may occur before SIP ACK request or SIP 200 "OK,", because the SIP 200 "OK" response travels through the SIP IP/Core, and the TBCP packet is sent directly from the PoC Server to the PoC Server.

B. TBCP Talk Burst Granted (PoC Server A to PoC Client A)

The PoC Server A sends TBCP Talk Burst Granted message to PoC Client A. This step may occur before SIP ACK request or SIP 200 "OK,", because the SIP 200 "OK" response travels through the SIP IP/Core, and the TBCP packet is sent directly from the PoC Server to the PoC Client.

18. SIP ACK request (PoC Client A to SIP/IP Core A)

The PoC Client A acknowledges the SIP 200 "OK" response with a SIP ACK request sent to the SIP/IP Core A.

19. SIP ACK request (SIP/IP Core A to PoC Server A)

The SIP/IP Core A forwards the SIP ACK request to the PoC Server A.

20. SIP ACK request (PoC Server A to SIP/IP Core A)

PoC Server A forwards the SIP ACK request to SIP/IP Core A.

21. SIP ACK request (SIP/IP Core A to SIP/IP Core X)

The SIP/IP Core A forwards the SIP ACK request to the SIP/IP Core X.

22. SIP ACK request (SIP/IP Core X to PoC Server X)

The SIP/IP Core X forwards the SIP ACK request to the PoC Server X.

C. PoC Client sends RTP Media to PoC Server A

The PoC Client A sends RTP Media packets to PoC Server A

D. PoC Client sends RTP Media to PoC Server A

The PoC Server A sends RTP Media packets to PoC Server X

F.16.2 Terminating flow – Manual Answer Override procedure

The signalling sequences in this subclause show the establishment of the Dispatch PoC Session using on-demand signalling in the terminating side. As a prerequisite for the on-demand signalling, PoC Client needs to be registered.

This flow shows the signalling sequence for the case of inviting a member of the Dispatch PoC Group as PoC Fleet Member.

QoE Profiles feature is used in this flow, QoE Profile defined for the Dispatch PoC Group is Professional QoE Profile and PoC Client B is subscribed and selects Professional as Local QoE Profile.

The Answer Mode of the terminating PoC User is set to manual answer and it is overridden because the initiator of the Dispatch PoC Session requested to override the manual Answer Mode. The flow is as shown in Figure 30 *"Dispatch PoC Session establishment on the terminating side with manual answer override"*.

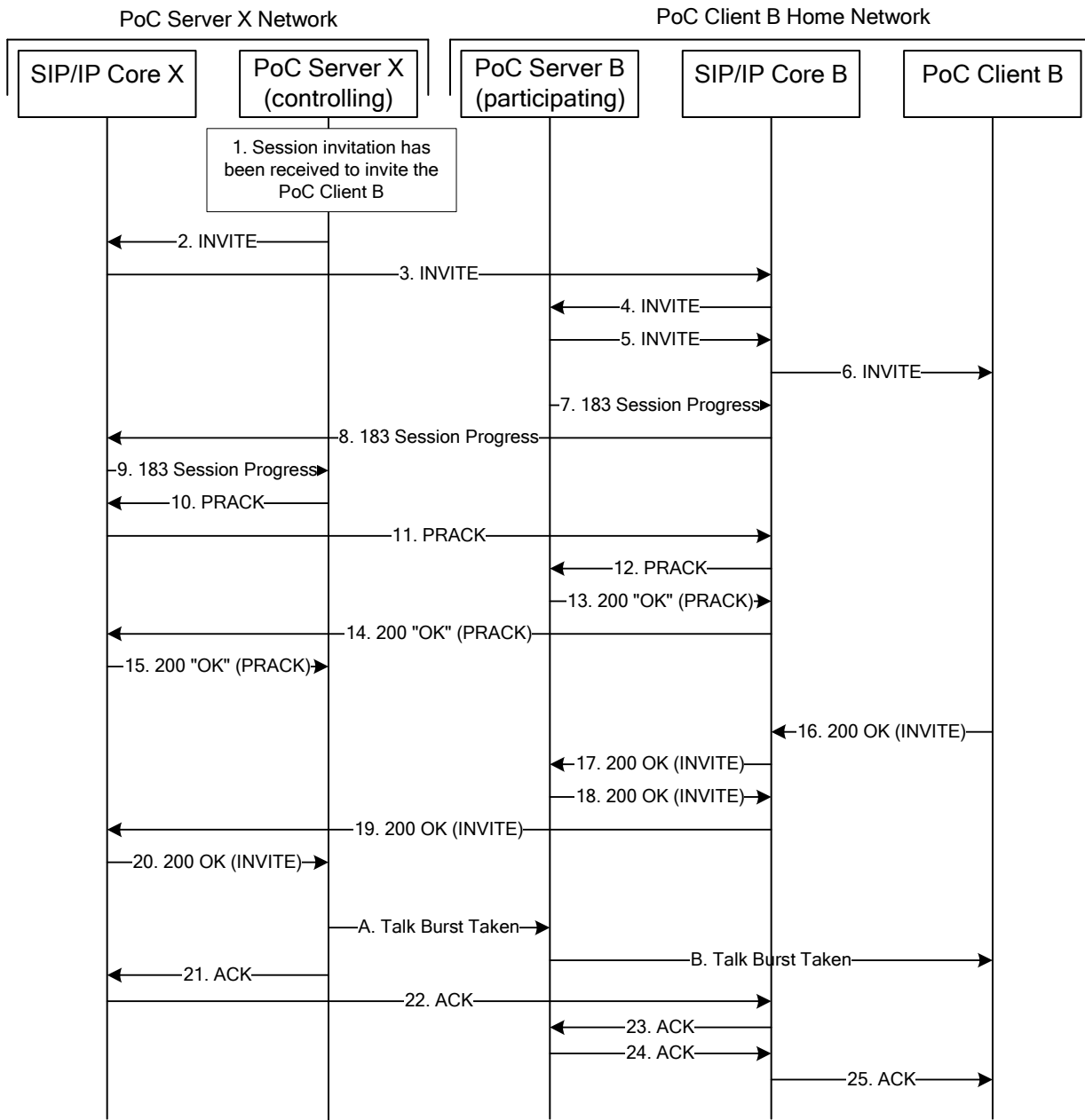

Figure 30: Dispatch PoC Session establishment on the terminating side with manual answer override

The steps of the flow are as follows:

1. Session invitation has been received to invite PoC Client
2. SIP INVITE request (from PoC Server X to SIP/IP Core X)

PoC Server X sends the SIP INVITE request to SIP/IP Core X.

The QoE Profile defined for the Dispatch PoC Group is Professional.

Request-URI sip:PoC-UserB@networkB.net

SIP HEADERS

P-Asserted-Identity: <sip:OMA-Highway-Maintenance-Company@networkX.net;session=prearranged>; dispatch=entire-group;

Accept-Contact: *,+g.poc.talkburst; require;explicit

User-Agent: PoC-serv/OMA2.0

Referred-By: "PoC User A" <sip:PoC-UserA@networkA.net>

Contact: <sip:PoC-SessionABCDEF@PoC-ServerX.networkX.net;session=prearranged>;+g.poc.talkburst;isfocus; dispatch=entire-group

Supported: 100rel, norefersub, timer

Session-Expires: 1800

Allow: INVITE,ACK,CANCEL,BYE,PRACK,UPDATE,REFER,OPTIONS

Priv-Answer-Mode: Auto

SDP PARAMETERS

c= IN IP6 50555::ccc:ddd:aaa:bbb

a= poc-qoe:professional mandatory

m= audio 53456 RTP/AVP 97 98

a= rtpmap:97 AMR

a= rtpmap:98 EVRC/8000

a= rtcp:53080

a= label:1

m= video 54567 RTP/AVP 34

a= rtpmap:34 H263/90000

a= rtcp:53090

a= label:2

m= Application 50000 udp TBCP

a= fntp:TBCP multimedia=1; queuing=1; tb_priority=2; timestamp=1

a= floorid:0 mstrm:1 2

3. SIP INVITE request (from SIP/IP Core X to SIP/IP Core B)

SIP/IP Core X forwards the SIP INVITE request to SIP/IP Core B.

Request-URI sip:PoC-UserB@networkB.net

SIP HEADERS

P-Asserted-Identity: <sip:OMA-Highway-Maintenance-Company@networkX.net;session=prearranged>; dispatch=entire-group;

Accept-Contact: *;+g.poc.talkburst; require;explicit

User-Agent: PoC-serv/OMA2.0

Referred-By: "PoC User A" <sip:PoC-UserA@networkA.net>

Contact: <sip:PoC-SessionABCDEF@PoC-ServerX.networkX.net;session=prearranged>;+g.poc.talkburst;isfocus; dispatch=entire-group

Supported: 100rel, norefersub, timer

Session-Expires: 1800

Allow: INVITE,ACK,CANCEL,BYE,PRACK,UPDATE,REFER,OPTIONS

Priv-Answer-Mode: Auto

SDP PARAMETERS

c= IN IP6 50555::ccc:ddd:aaa:bbb

a= poc-qoe:professional mandatory

m= audio 53456 RTP/AVP 97 98

a= rtpmap:97 AMR

a= rtpmap:98 EVRC/8000

a= rtcp:53080

a= label:1

m= video 54567 RTP/AVP 34

a= rtpmap:34 H263/90000

a= rtcp:53090

a= label:2

m= Application 50000 udp TBCP

a= fmp: TBCP multimedia=1; queuing=1; tb_priority=2; timestamp=1

a= floorid:0 mstrm:1 2

4. SIP INVITE request (from SIP/IP Core B to PoC Server B)

SIP/IP Core B forwards the SIP INVITE request to PoC Server B.

Request-URI sip:PoC-UserB@networkB.net

SIP HEADERS

P-Asserted-Identity: <sip:OMA-Highway-Maintenance-Company@networkX.net;session=prearranged>; dispatch=entire-group;

Accept-Contact: *,+g.poc.talkburst; require;explicit

User-Agent: PoC-serv/OMA2.0

Referred-By: "PoC User A" <sip:PoC-UserA@networkA.net>

Contact: <sip:PoC-SessionABCDEF@PoC-ServerX.networkX.net;session=prearranged>;+g.poc.talkburst;isfocus; dispatch=entire-group

Supported: 100rel, norefersub, timer

Session-Expires: 1800

Allow: INVITE,ACK,CANCEL,BYE,PRACK,UPDATE,REFER,OPTIONS

Priv-Answer-Mode: Auto

SDP PARAMETERS

c= IN IP6 50555::ccc:ddd:aaa:bbb

a= poc-qoe:professional mandatory

m= audio 53456 RTP/AVP 97 98

a= rtpmap:97 AMR

a= rtpmap:98 EVRC/8000

a= rtcp:53080

a= label:1

m= video 54567 RTP/AVP 34

a= rtpmap:34 H263/90000

a= rtcp:53090

a= label:2

m= Application 50000 udp TBCP

a= fmp:TBCP multimedia=1; queuing=1; tb_priority=2; timestamp=1

a= floorid:0 mstrm:1 2

5. SIP INVITE request (from PoC Server B to SIP/IP Core B)

PoC Server B sends a SIP INVITE request to SIP/IP Core B.

Request-URI sip:PoC-UserB@networkB.net

SIP HEADERS

P-Asserted-Identity: <sip:OMA-Highway-Maintenance-Company@networkX.net;session=prearranged>; dispatch=entire-group;

Accept-Contact: *;+g.poc.talkburst; require;explicit

User-Agent: PoC-serv/OMA2.0

Referred-By: "PoC User A" <sip:PoC-UserA@networkA.net>

Contact: <sip:PoC-SessionABCDEF@PoC_ServerB.networkB.net; session=prearranged>; +g.poc.talkburst;isfocus; dispatch=entire-group

Supported: norefersub,timer

Session-Expires: 1800;

Priv-Answer-Mode: Auto

Allow: INVITE,ACK,CANCEL,BYE,PRACK,UPDATE,REFER,OPTIONS

SDP PARAMETERS

c= IN IP6 60333::ddd: ccc:aaa:bbb

a= poc-qoe:professional mandatory

m= audio 63776 RTP/AVP 98

a= rtpmap:98 EVRC/8000

a= rtcp:63090

a= label:1

m= video 63886 RTP/AVP 34

a= rtpmap:34 H263/90000

a= rtcp:63190

a= label:2

m= Application 60000 udp TBCP

a= fmp: TBCP multimedia=1; queuing=1; tb_priority=2; timestamp=1

a= floorid:0 mstrm:1 2

6. SIP INVITE request (from SIP/IP Core B to PoC Client B)

SIP/IP Core B forwards the SIP INVITE request to PoC Client B.

Request-URI sip:PoC-UserB@networkB.net

SIP HEADERS

P-Asserted-Identity: <sip:OMA-Highway-Maintenance-Company@networkX.net;session=prearranged>; dispatch=entire-group;

Accept-Contact: *,+g.poc.talkburst; require;explicit

User-Agent: PoC-serv/OMA2.0

Referred-By: "PoC User A" <sip:PoC-UserA@networkA.net>

Contact: <sip:PoC-SessionABCDEF@PoC_ServerB.networkB.net; session=prearranged>; +g.poc.talkburst;isfocus; dispatch=entire-group

Supported: norefersub,timer

Session-Expires: 1800;

Priv-Answer-Mode: Auto

Allow: INVITE,ACK,CANCEL,BYE,PRACK,UPDATE,REFER,OPTIONS

SDP PARAMETERS

c= IN IP6 60333::ddd:ccc:aaa:bbb

a= poc-qoe:professional mandatory

m= audio 63776 RTP/AVP 98

a= rtpmap:98 EVRC/8000

a= rtcp:63090

a= label:1

m= video 63886 RTP/AVP 34

a= rtpmap:34 H263/90000

a= rtcp:63190

a= label:2

m= Application 60000 udp TBCP

a= fmp: TBCP multimedia=1; queuing=1; tb_priority=2; timestamp=1

a= floorid:0 mstrm:1 2

7. SIP 183 "Session Progress" response (from PoC Server B to SIP/IP Core B)

PoC Server B sends a SIP 183 "Session Progress" response to SIP/IP Core B.

SIP HEADERS

P-Asserted-Identity: "PoC User B" <sip:PoC-UserB@networkB.net>
Require: 100rel
Server: PoC-Serv/OMA2.0
Contact: <sip:PoC-SessionABCDEF@PoC-ServerB.networkB.net>;+g.poc.talkburst
P-Answer-State: Unconfirmed
Allow: INVITE,ACK,CANCEL,BYE, PRACK, UPDATE, REFER,OPTIONS

8. SIP 183 "Session Progress" response (from SIP/IP Core B to SIP/IP Core X)

SIP/IP Core B forwards the SIP 183 "Session Progress" response to SIP/IP Core X.

SIP HEADERS

P-Asserted-Identity: "PoC User B" <sip:PoC-UserB@networkB.net>
Require: 100rel
Server: PoC-Serv/OMA2.0
Contact: <sip:PoC-SessionABCDEF@PoC-ServerB.networkB.net>;+g.poc.talkburst
P-Answer-State: Unconfirmed
Allow: INVITE,ACK,CANCEL,BYE, PRACK, UPDATE, REFER,OPTIONS

9. SIP 183 "Session Progress" response (from SIP/IP Core X to PoC Server X)

SIP/IP Core B forwards the SIP 183 "Session Progress" response to PoC Server X.

SIP HEADERS

P-Asserted-Identity: "PoC User B" <sip:PoC-UserB@networkB.net>
Require: 100rel
Server: PoC-Serv/OMA2.0
Contact: <sip:PoC-SessionABCDEF@PoC-ServerB.networkB.net>;+g.poc.talkburst
P-Answer-State: Unconfirmed
Allow: INVITE,ACK,CANCEL,BYE, PRACK, UPDATE, REFER,OPTIONS

10. SIP PRACK request (from PoC Server X to SIP/IP Core X)

If PoC Server B requested SIP 183 "Session progress" response to be sent reliably, PoC Server X sends a SIP PRACK request to the SIP/IP Core X.

Request-URI sip:PoC-SessionABCDEF@PoC-ServerB.networkB.net

11. SIP PRACK request (from SIP/IP Core X to SIP/IP Core B)

SIP/IP Core X forwards the SIP PRACK request to SIP/IP Core B.

Request-URI sip:PoC-SessionABCDEF@PoC-ServerB.networkB.net

12. SIP PRACK request (from SIP/IP Core B to PoC Server B)

SIP/IP Core B forwards SIP PRACK request to PoC Server B.

Request-URI sip:PoC-SessionABCDEF@PoC-ServerB.networkB.net

13. SIP 200 "OK" response to the SIP PRACK request (from PoC Server B to SIP/IP Core B)

PoC Server B sends a SIP 200 "OK" response to SIP/IP Core B.

14. SIP 200 "OK" response to the SIP PRACK request (from SIP/IP Core B to SIP/IP Core X)

SIP/IP Core B forwards the SIP 200 "OK" response to SIP/IP core X.

15. SIP 200 "OK" response to the SIP PRACK request (from SIP/IP Core X to PoC Server X)

SIP/IP Core X forwards the SIP 200 "OK" response to PoC Server X.

16. SIP 200 "OK" response to the SIP INVITE request (from PoC Client B to SIP/IP Core B)

PoC Client B sends a SIP 200 "OK" response to SIP/IP Core B.

SIP HEADERS

To: "PoC User B"<sip:PoC-ClientB.networkB.net>
Server: PoC-client/OMA2.0 Acme-Talk5000/v1.01
Contact: <sip:PoC-ClientB.networkB.net >;+sip.instance="<urn:uuid:00000000-0000-1000-8000-000A95A0E128>";+g.poc.talkburst
Require: timer
Session-Expires: 1800;refresher=uas
Allow: INVITE,ACK,CANCEL,BYE,REFER,MESSAGE, SUBSCRIBE, NOTIFY, PUBLISH,OPTIONS

SDP PARAMETERS

c= IN IP6 75555::eee:aaa:fff:bbb

a= poc-qoe:professional
m= audio 75575 RTP/AVP 98
a= rtpmap:98 EVRC/8000
a= rtcp:75000
a= label:1
m= video 75676 RTP/AVP 34
a= rtpmap:34 H263/90000
a= rtcp:75100
a= label:2
m= application 75590 udp TBCP
a= fmp: TBCP multimedia=1; queuing=1; tb_priority=2; timestamp=1
a= floorid:0 mstrm:1 2

17. SIP 200 "OK" response to the SIP INVITE request (from SIP/IP Core B to PoC Server B)

SIP/IP Core B forwards the SIP 200 "OK" response to PoC Server B.

SIP HEADERS

To: "PoC User B"<sip:PoC-ClientB.networkB.net>
Server: PoC-client/OMA2.0 Acme-Talk5000/v1.01
Contact: <sip:PoC-ClientB.networkB.net
>;+g.poc.talkburst+sip.instance="<urn:uuid:00000000-0000-1000-8000-000A95A0E128>"
Require: timer
Session-Expires: 1800;refresher=uas
Allow: INVITE,ACK,CANCEL,BYE,REFER,MESSAGE, SUBSCRIBE, NOTIFY, PUBLISH,OPTIONS

SDP PARAMETERS

c= IN IP6 75555::eee:aaa:fff:bbb
a= poc-qoe:professional
m= audio 75575 RTP/AVP 98
a= rtpmap:98 EVRC/8000
a= rtcp:75000
a= label:1

m= video 75676 RTP/AVP 34
a= rtpmap:34 H263/90000
a= rtcp:75100
a= label:2
m= application 75590 udp TBCP
a= fmp: TBCP multimedia=1; queuing=1; tb_priority=2; timestamp=1
a= floorid:0 mstrm:1 2

18. SIP "OK" response to the SIP INVITE request (from PoC Server B to SIP/IP Core B)

PoC Server B sends a SIP 200 "OK" response to SIP/IP Core B.

SIP HEADERS

P-Asserted-Identity: "PoC User B" <sip:PoC-UserB@networkB.net>
Require: timer
Session-Expires: 1800;refresher=uas
Server: PoC-Serv/OMA2.0
Contact: <sip:PoC-SessionABCDEF@PoC-ServerB.networkB.net>;+g.poc.talkburst
P-Answer-State: Confirmed

SDP PARAMETERS

c= IN IP6 99055::fff:aaa:eee:bbb
a= poc-qoe:professional
m= audio 99006 RTP/AVP 98
a= rtpmap:98 EVRC/8000
a= rtcp:90000
a= label:1
m= video 99106 RTP/AVP 34
a= rtpmap:34 H263/90000
a= rtcp:90100
a= label:2
m= application 90000 udp TBCP
a= fmp: TBCP multimedia=1; queuing=1; tb_priority=2; timestamp=1
a= floorid:0 mstrm:1 2

19. SIP "OK" response to the SIP INVITE request (from PoC SIP/IP Core B to SIP/IP Core X)

SIP/IP Core B forwards the SIP 200 "OK" response to SIP/IP Core X.

SIP HEADERS

P-Asserted-Identity: "PoC User B" <sip:PoC-UserB@networkB.net>
Require: timer
Session-Expires: 1800;refresher=uas
Server: PoC-Serv/OMA2.0
Contact: <sip:PoC-SessionABCDEF@PoC-ServerB.networkB.net>;+g.poc.talkburst
P-Answer-State: Confirmed

SDP PARAMETERS

c= IN IP6 99055::fff:aaa:eee:bbb
a= poc-qoe:professional
m= audio 99006 RTP/AVP 98
a= rtpmap:98 EVRC/8000
a= rtcp:90000
a= label:1
m= video 99106 RTP/AVP 34
a= rtpmap:34 H263/90000
a= rtcp:90100
a= label:2
m= application 90000 udp TBCP
a= fmp: TBCP multimedia=1; queuing=1; tb_priority=2; timestamp=1
a= floorid:0 mstrm:1 2

20. SIP "OK" response to the SIP INVITE request (from SIP/IP Core X to PoC Server X)

SIP/IP Core X forwards the SIP 200 "OK" response to PoC Server X.

SIP HEADERS

P-Asserted-Identity: "PoC User B" <sip:PoC-UserB@networkB.net>
Require: timer

Session-Expires: 1800;refresher=uas
Server: PoC-Serv/OMA2.0
Contact: <sip:PoC-SessionABCDEF@PoC-ServerB.networkB.net>;+g.poc.talkburst
P-Answer-State: Confirmed

SDP PARAMETERS

c= IN IP6 99055::fff:aaa:eee:bbb
a= poc-qoe:professional
m= audio 99006 RTP/AVP 98
a= rtpmap:98 EVRC/8000
a= rtcp:90000
a= label:1
m= video 99106 RTP/AVP 34
a= rtpmap:34 H263/90000
a= rtcp:90100
a= label:2
m= application 90000 udp TBCP
a= fmp: TBCP multimedia=1 queuing=1; tb_priority=2; timestamp=1
a= floorid:0 mstrm:1 2

A. TBCP Talk Burst Taken message (from the PoC Server X to the PoC Server B).

The TBCP Talk Burst Taken message is sent to inform the PoC Client B that another PoC Client has been granted to send a Talk Burst. The message contains the identity of PoC User at the granted PoC Client.

B. TBCP Talk Burst Taken message (from the PoC Server B to the PoC Client B).

The TBCP Talk Burst Taken message is sent to inform the PoC Client B that another PoC Client has been granted to send a Talk Burst. The message contains the identity of PoC User at the granted PoC Client.

21. SIP ACK request (from PoC Server X to SIP/IP Core X)

PoC Server X sends a SIP ACK request to SIP/IP Core X.

22. SIP ACK request (from SIP/IP Core X to SIP/IP Core B)

SIP/IP Core X forwards the SIP ACK request to SIP/IP Core B.

23. SIP ACK request (from SIP/IP Core B to PoC Server B)

SIP/IP Core B forwards the SIP ACK request to PoC Server B.

24. SIP ACK request (from PoC Server B to SIP/IP Core B)

PoC Server B sends a SIP ACK request to SIP/IP Core B.

25. SIP ACK request (from SIP/IP Core B to PoC Client B)

SIP/IP Core B forwards the SIP ACK request to PoC Client B.

F.17 Full Duplex Call Follow-on Proceed

This subclause shows an example of how one Participant can ask other Participants to switch from the PoC Session to a full duplex call.

F.17.1 Originating flow

This subclause describes the Full Duplex Call Follow-On Proceed message flow between the PoC Client A participating in the PoC Session Q and the PoC Server X performing the Controlling PoC Function of the PoC Session Q.

The PoC Client A is sending the Full Duplex Call Follow-on Proceed request to all the Participants of the PoC Session Q whose PoC Clients support Full Duplex Call Follow-on Proceed.

The PoC Server A is a SIP B2BUA in the PoC Session Q.

The SIP MESSAGE request is sent within the SIP dialog of the PoC Session.

NOTE: The Request URI is set according to the SIP dialog.

The flow is as shown in Figure 31 "*PoC Client A sends the Full Duplex Call Follow-on Proceed request*".

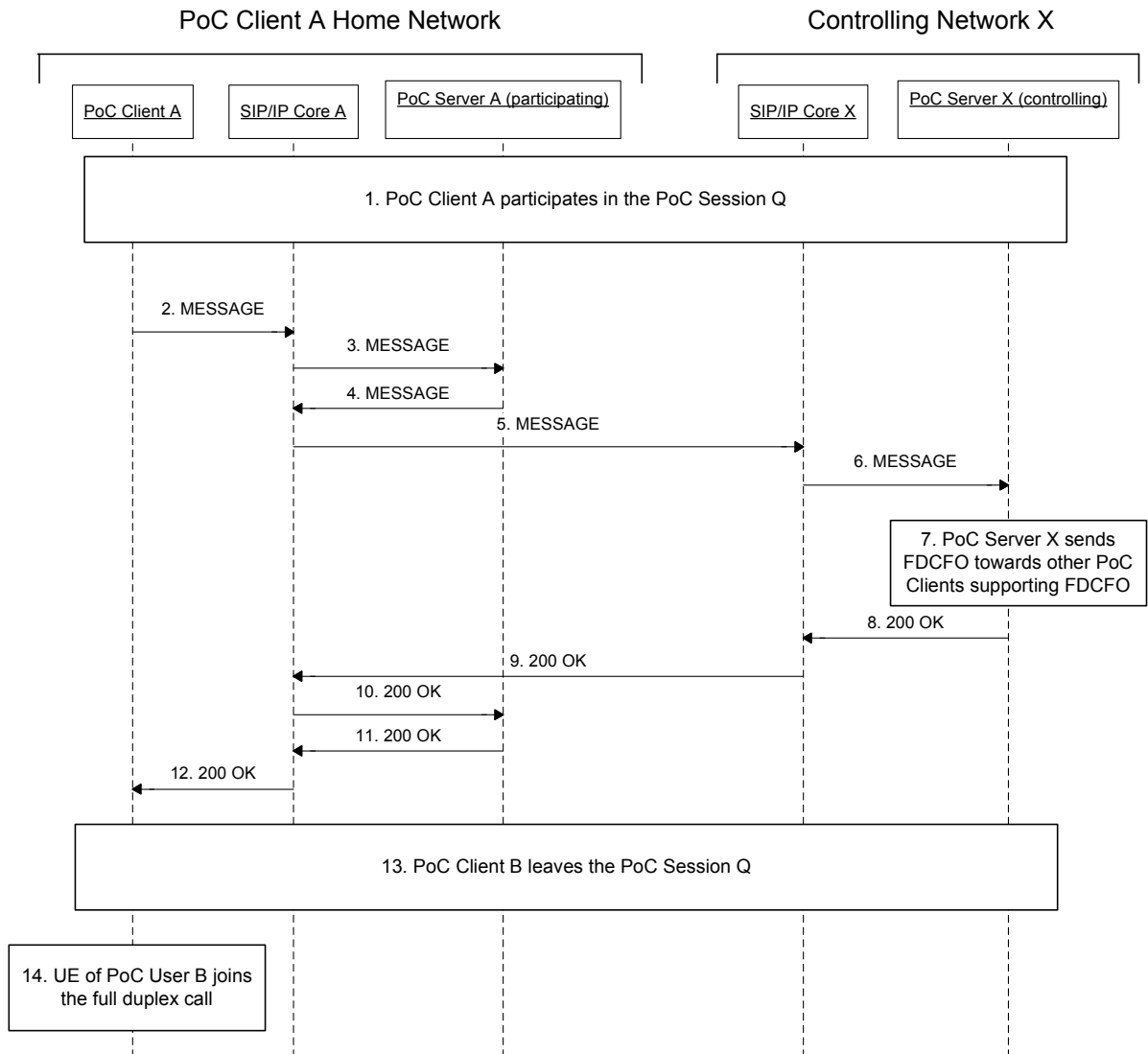

Figure 31: PoC Client A sends the Full Duplex Call Follow-on Proceed request

1. The PoC Client A participates in the PoC Session Q.
2. SIP MESSAGE request (from PoC Client A to SIP/IP Core A)

Request-URI sip:PoCSessionQ%networkX.net@networkA.net

SIP HEADERS

P-Preferred-Identity: "PoC User A" <sip:PoC-UserA@networkA.net>

Content-Type: application/vnd.poc.fdcfo+xml
User-Agent: PoC-client/OMA2.0 vendorOfPoCClientA

XML MIME BODY

```
<?xml version="1.0" encoding="UTF-8"?>
<resource-lists
  xmlns="urn:ietf:params:xml:ns:resource-lists"
  xmlns:fdcfo="urn:oma:xml:poc:fdcfo"
  >
  <list name="My conference">
    <entry uri="sip:myconference@conferencebridge.com"/>
    <entry uri="tel:+15555555555">
      <fdcfo:postd>23456#</fdcfo:postd>
    </entry>
  </list>
</resource-lists>
```

3. SIP MESSAGE request (from SIP/IP Core A to PoC Server A)

Request-URI sip:PoCSessionQ%networkX.net@networkA.net

SIP HEADERS

P-Asserted-Identity: "PoC User A" <sip:PoC-UserA@networkA.net>

Content-Type: application/vnd.poc.fdcfo+xml

User-Agent: PoC-client/OMA2.0 vendorOfPoCClientA

XML MIME BODY

```
<?xml version="1.0" encoding="UTF-8"?>
<resource-lists
  xmlns="urn:ietf:params:xml:ns:resource-lists"
  xmlns:fdcfo="urn:oma:xml:poc:fdcfo"
  >
```



```

>
<list name="My conference">
  <entry uri="sip:myconference@conferencebridge.com"/>
  <entry uri="tel:+15555555555">
    <fdco:postd>23456#</fdco:postd>
  </entry>
</list>
</resource-lists>

```

4. SIP MESSAGE request (from PoC Server A to SIP/IP Core A)

Request-URI sip:PoCSessionQ@networkX.net

SIP HEADERS

P-Asserted-Identity: "PoC User A" <sip:PoC-UserA@networkA.net>

Content-Type: application/vnd.poc.fdcfo+xml

User-Agent: PoC-serv/OMA2.0 vendorOfPoCServerA

XML MIME BODY

```

<?xml version="1.0" encoding="UTF-8"?>
<resource-lists
  xmlns="urn:ietf:params:xml:ns:resource-lists"
  xmlns:fdco="urn:oma:xml:poc:fdco"
>
  <list name="My conference">
    <entry uri="sip:myconference@conferencebridge.com"/>
    <entry uri="tel:+15555555555">
      <fdco:postd>23456#</fdco:postd>
    </entry>
  </list>
</resource-lists>

```

5. SIP MESSAGE request (from SIP/IP Core A to SIP/IP Core X)

The PoC specific elements are the same as in the previous message.

6. SIP MESSAGE request (from SIP/IP Core X to PoC Server X)

The PoC specific elements are the same as in the previous message.

7. PoC Server sends a Full Duplex Call Follow-on Proceed request to each Participant whose PoC Client supports the Full Duplex Call Follow-on Proceed.**8. SIP 200 "OK" response (from PoC Server X to SIP/IP Core X)**

Upon receiving the first SIP 2xx response for the SIP MESSAGE requests sent in previous step, a SIP 200 "OK" response to the SIP MESSAGE request is sent to towards the PoC Client A.

SIP HEADERS

Server: PoC-serv/OMA2.0 vendorOfPoCServerX

9. SIP 200 "OK" response (from SIP/IP Core X to SIP/IP Core A)

The PoC specific elements are the same as in the previous message.

10. SIP 200 "OK" response (from SIP/IP Core A to PoC Server A)

The PoC specific elements are the same as in the previous message.

11. SIP 200 "OK" response (from PoC Server A to SIP/IP Core A)**SIP HEADERS**

Server: PoC-serv/OMA2.0 vendorOfPoCServerA

12. SIP 200 "OK" response (from SIP/IP Core A to PoC Client A)

The PoC specific elements are the same as in the previous message.

13. PoC Client A leaves the PoC Session**14. UE of the PoC User A joins the full duplex call at one of the addresses listed in the sent Full Duplex Call Follow-On Proceed document.**

F.17.2 Terminating flow

This subclause describes the Full Duplex Call Follow-On Proceed message flow between the PoC Server X performing the Controlling PoC Function of the PoC Session Q and the PoC Client B participating in the PoC Session Q.

The PoC Client B is receiving the Full Duplex Call Follow-on Proceed request sent by PoC Client A.

The PoC Server B is a SIP B2BUA in the PoC Session Q.

The SIP MESSAGE request is sent within the SIP dialog of the PoC Session.

NOTE: The Request URI is set according to the SIP dialog.

The flow is as shown in Figure 32 "PoC Client B receives the Full Duplex Call Follow-on Proceed request".

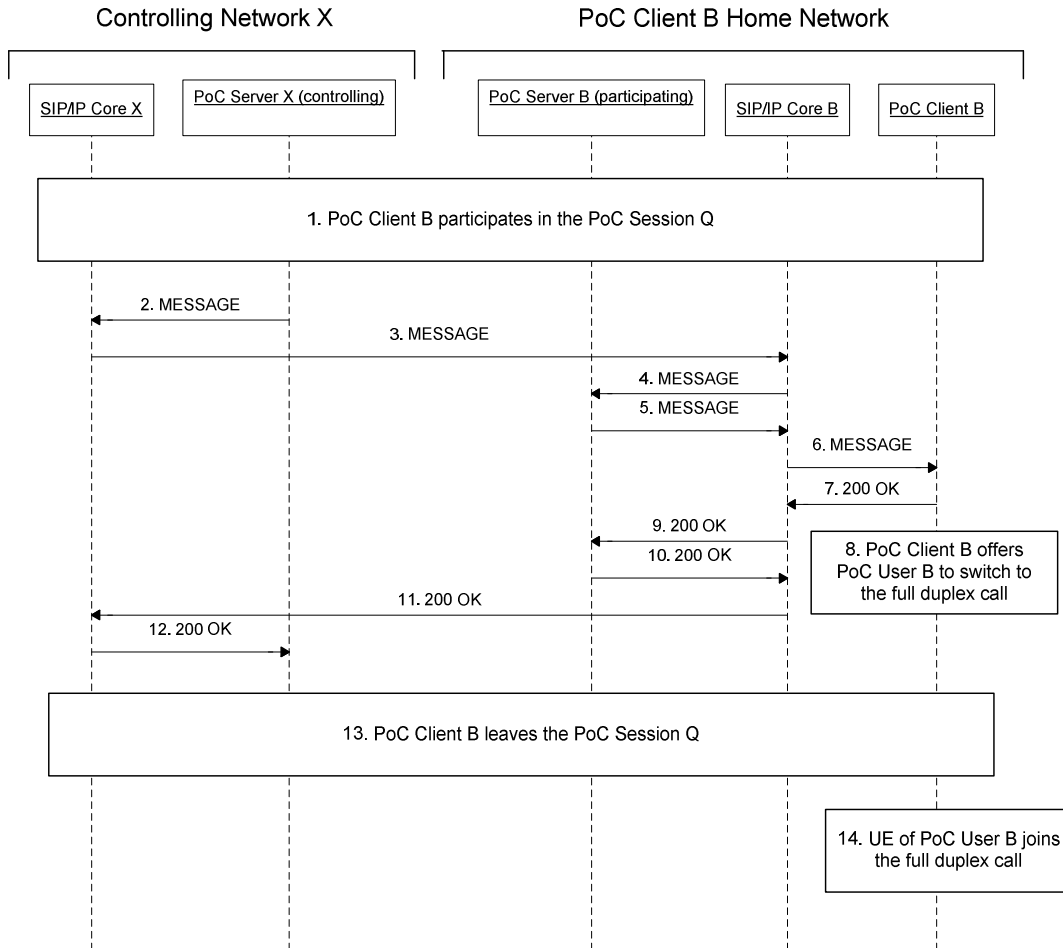

Figure 32: PoC Client B receives the Full Duplex Call Follow-on Proceed request

1. The PoC Client B participates in the PoC Session Q.
2. SIP MESSAGE request (from PoC Server X to SIP/IP Core X)

Upon reception of the Full Duplex Call Follow-on Proceed request from the PoC Client A, the PoC Server X sends a SIP MESSAGE request to SIP/IP Core X for each PoC Client B which supports the Full Duplex Call Follow-On Proceed.

Request-URI sip:PoC-UserB@networkB.net

SIP HEADERS

P-Asserted-Identity: "PoC User A" <sip:PoC-UserA@networkA.net>

Content-Type: application/vnd.poc.fdcfo+xml
User-Agent: PoC-serv/OMA2.0 vendorOfPoCServerX

XML MIME BODY

```
<?xml version="1.0" encoding="UTF-8"?>
<resource-lists
  xmlns="urn:ietf:params:xml:ns:resource-lists"
  xmlns:fdcfo="urn:oma:xml:poc:fdcfo"
  >
  <list name="My conference">
    <entry uri="sip:myconference@conferencebridge.com"/>
    <entry uri="tel:+15555555555">
      <fdcfo:postd>23456#</fdcfo:postd>
    </entry>
  </list>
</resource-lists>
```

3. SIP MESSAGE request (from SIP/IP Core X to SIP/IP Core B)

The PoC specific elements are the same as in the previous message.

4. SIP MESSAGE request (from SIP/IP Core B to PoC Server B)

The PoC specific elements are the same as in the previous message.

5. SIP MESSAGE request (from PoC Server B to SIP/IP Core B)

Request-URI sip:PoC-UserB@networkB.net

SIP HEADERS

P-Asserted-Identity: "PoC User A" <sip:PoC-UserA@networkA.net>

Content-Type: application/vnd.poc.fdcfo+xml

User-Agent: PoC-serv/OMA2.0 vendorOfPoCServerB

XML MIME BODY

```
<?xml version="1.0" encoding="UTF-8"?>
<resource-lists
  xmlns="urn:ietf:params:xml:ns:resource-lists"
  xmlns:fdcfo="urn:oma:xml:poc:fdcfo"
  >
  <list name="My conference">
    <entry uri="sip:myconference@conferencebridge.com"/>
    <entry uri="tel:+15555555555">
      <fdcfo:postd>23456#</fdcfo:postd>
    </entry>
  </list>
</resource-lists>
```

6. SIP MESSAGE request (from SIP/IP Core B to PoC Client B)

The PoC specific elements are the same as in the previous message.

7. SIP "200" response (from PoC Client B to SIP/IP Core B)**SIP HEADERS**

Server: PoC-client/OMA2.0 vendorOfPoCClientB

8. The PoC Client B informs the PoC User B about the incoming Full Duplex Call Follow-on Proceed request.**9. SIP "200" response (from SIP/IP Core B to PoC Server B)****SIP HEADERS**

Server: PoC-client/OMA2.0 vendorOfPoCClientB

10. SIP "200" response (from PoC Server B to SIP/IP Core B)**SIP HEADERS**

Server: PoC-serv/OMA2.0 vendorOfPoCServerB

11. SIP "200" response (from SIP/IP Core B to SIP/IP Core X)

The PoC specific elements are the same as in the previous message.

12. SIP "200" response (from SIP/IP Core X to PoC Server X)

The PoC specific elements are the same as in the previous message.

13. The PoC User B decides to accept the incoming Full Duplex Call Follow-on Proceed request and leaves the PoC Session Q.**14. UE of the PoC User B joins the full duplex call at one of the addresses listed in the sent Full Duplex Call Follow-On Proceed document.**

F.18 Backward compatibility

This subclause shows examples of cooperation of PoC Server compliant to the PoC version 2.0 specification with the PoC Server compliant only to the PoC version 1.0 specification.

The flows in this subclause do not relate to each other.

F.18.1 Backward compatibility towards Controlling PoC Function

This subclause describes the PoC Session invitation message flow when the PoC Client A with the PoC Server A performing the Participating PoC Function compliant to the PoC version 2.0 specification attempts to join a Chat PoC Group Session hosted by the PoC Server X performing the Controlling PoC Function compliant only to the PoC version 1.0 specification.

The PoC Client A does not support the FDCFO and Discrete Media sent over the SIP MESSAGE request. The PoC Client A does not request anonymity.

The PoC Server A stays in the Media path.

The flow is as shown in Figure 33 "*Backward compatibility with the PoC Server performing the Controlling PoC Function compliant only to the PoC version 1.0 specification*". The SIP 100 "Trying" responses to SIP INVITE requests are not shown in the figure.

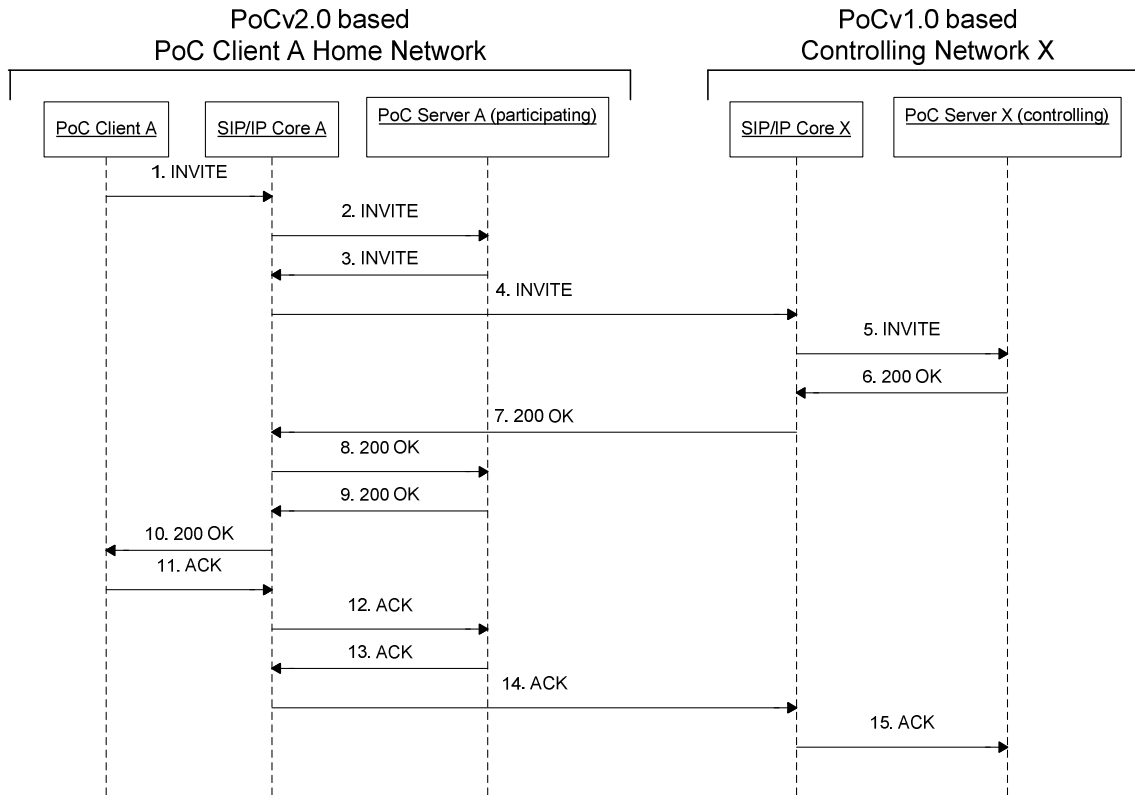

Figure 33: Backward compatibility with the PoC Server performing the Controlling PoC Function compliant only to the PoC version 1.0 specification

1. SIP INVITE request (from PoC Client A to SIP/IP Core A)

Request-URI sip:ChatPoCGroupXXXX@networkX.net

SIP HEADERS

P-Preferred-Identity: "PoC User A" <sip:PoC-UserA@networkA.net>

Accept-Contact: *,+g.poc.talkburst; require;explicit

User-Agent: PoC-client/OMA2.0

Contact: <sip:[5555::aaa:bbb:ccc:ddd]:5060>;+g.poc.talkburst+sip.instance="<urn:uuid:0000000-0000-1000-8000-000A95A0E128>";

Supported: timer

Session-Expires: 1800

Allow: INVITE,ACK,CANCEL,BYE,REFER,OPTIONS,MESSAGE

Accept-Language: en

SDP PARAMETERS

Content-Type: application/sdp

c= IN IP6 5555::aaa:bbb:ccc:ddd
a= poc-qoe:premium
m= audio 3456 RTP/AVP 97
a= rtpmap:97 AMR
a= rtcp:5560
i= speech
b= AS:25.4
a= label:aa
m= application 5560 udp TBCP
a= fntp:TBCP queuing=1; tb_priority=2;
 timestamp=1;multimedia=1;local_grant=1;imp_mb_req=1
a= floorid:0 mstrm:aa bb
m= video 5678 RTP/AVP 99
a= rtpmap:99 MP4V-ES
b= AS:75
a= label:bb
m= message 12345 TCP/MSRP *
a= accept-types:message/cpim application/vnd.oma.poc.final-report+xml
 application/vnd.oma.poc.detailed-progress-report+xml
 application/vnd.oma.poc.optimized-progress-report+xml
a= accept-wrapped-types:text/plain
a= path:msrp://[5555::aaa:bbb:ccc:ddd]:12345/kjhd37s2s20w2a;tcp
a= max-size:10000

2. SIP INVITE request (from SIP/IP Core A to PoC Server A)

Request-URI sip:ChatPoCGroupXXXX@networkX.net

SIP HEADERS

P-Asserted-Identity: "PoC User A" <sip:PoC-UserA@networkA.net>
Accept-Contact: *,+g.poc.talkburst; require;explicit
User-Agent: PoC-client/OMA2.0
Contact: <sip:[5555::aaa:bbb:ccc:ddd]:5060>;+sip.instance="<urn:uuid:00000000-0000-1000-8000-000A95A0E128>";+g.poc.talkburst
Supported: timer
Session-Expires: 1800
Allow: INVITE,ACK,CANCEL,BYE,REFER,OPTIONS,MESSAGE
Accept-Language: en

SDP PARAMETERS

Content-Type: application/sdp

c= IN IP6 5555::aaa:bbb:ccc:ddd
a= poc-qoe:premium
m= audio 3456 RTP/AVP 97
a= rtpmap:97 AMR
a= rtcp:5560
i= speech
b= AS:25.4
a= label:aa
m= application 5560 udp TBCP
a= fntp:TBCP queuing=1; tb_priority=2; timestamp=1;multimedia=1;local_grant=1;imp_mb_req=1
a= floorid:0 mstrm:aa bb
m= video 5678 RTP/AVP 99
a= rtpmap:99 MP4V-ES
b= AS:75
a= label:bb
m= message 12345 TCP/MSRP *
a= accept-types:message/cpim application/vnd.oma.poc.final-report+xml
 application/vnd.oma.poc.detailed-progress-report+xml
 application/vnd.oma.poc.optimized-progress-report+xml
a= accept-wrapped-types:text/plain

a= path:msrp://[5555::aaa:bbb:ccc:ddd]:12345/kjhd37s2s20w2a;tcp
a= max-size:10000

3. SIP INVITE request (from PoC Server A to SIP/IP Core A)

Request-URI sip:ChatPoCGroupXXXX@networkX.net

SIP HEADERS

P-Asserted-Identity: "PoC User A" <sip:PoC-UserA@networkA.net>
Accept-Contact: *,+g.poc.talkburst; require;explicit
User-Agent: PoC-serv/OMA2.0
Contact: <sip:sessionabcdef@PoCServerA.networkA.net;b2bua>;+g.poc.talkburst
Supported: timer
Session-Expires: 1800
Allow: INVITE,ACK,CANCEL,BYE,REFER,OPTIONS,MESSAGE
Accept-Language: en

SDP PARAMETERS

Content-Type: application/sdp

c= IN IP6 5055::ccc:ddd:aaa:bbb
a= poc-qoe:premium
m= audio 5468 RTP/AVP 97
a= rtpmap:97 AMR
a= rtcp:5469
i= speech
b= AS:25.4
a= label:aa
m= application 5469 udp TBCP
a= fmp: TBCP queuing=1; tb_priority=2;
timestamp=1;multimedia=1;local_grant=1;imp_mb_req=1
a= floorid:0 mstrm:aa bb

m= video 5678 RTP/AVP 99
a= rtpmap:99 MP4V-ES
b= AS:75
a= label:bb
m= message 23456 TCP/MSRP *
a= accept-types:message/cpim application/vnd.oma.poc.final-report+xml
application/vnd.oma.poc.detailed-progress-report+xml
application/vnd.oma.poc.optimized-progress-report+xml
a= accept-wrapped-types:text/plain
a= path:msrp://[5055::ccc:ddd:aaa:bbb]:12345/xxxkjhd37s2s20w2a;tcp
a= max-size:10000

4. SIP INVITE request (from SIP/IP Core A to SIP/IP Core X)

The PoC specific elements are the same as in the previous message.

5. SIP INVITE request (from SIP/IP Core X to PoC Server X)

The PoC specific elements are the same as in the previous message.

6. SIP 200 "OK" response (from PoC Server X to SIP/IP Core X)

SIP HEADERS

P-Asserted-Identity: <sip:ChatPoCGroupXXXX@networkX.net;session=chat>
Server: PoC-serv/OMA1.0
Contact: <sip:PoC-SessionABCDEF@PoC-
ServerX.networkX.net;session=chat>;+g.poc.talkburst;isfocus
Require: timer
Session-Expires: 1800;refresher=uac
Allow: INVITE,ACK,CANCEL,BYE,REFER
Content-Type: application/sdp

SDP PARAMETERS

c= IN IP6 5777::eee:fff:aaa:bbb
m= audio 57786 RTP/AVP 97
a= rtpmap:97 AMR
a= rtcp:57787

m= application 57787 udp TBCP
 a= fmp: TBCP queuing=1;tb_priority=2;timestamp=1
 m= video 0 RTP/AVP 99
 m= message 0 TCP/MSRP *

7. SIP 200 "OK" response (from SIP/IP Core X to SIP/IP Core A)

The PoC specific elements are the same as in the previous message.

8. SIP 200 "OK" response (from SIP/IP Core A to PoC Server A)

The PoC specific elements are the same as in the previous message.

9. SIP 200 "OK" response (from PoC Server A to SIP/IP Core A)

SIP HEADERS

P-Asserted-Identity: <sip:ChatPoCGroupXXXX@networkX.net;session=chat>
Server: PoC-serv/OMA2.0
Contact: <sip:sessionabcdef@PoCServerA.networkA.net;session=chat>;+g.poc.talkburst;isfocus
Require: timer
Session-Expires: 1800;refresher=uac
Allow: INVITE,ACK,CANCEL,BYE,REFER
Content-Type: application/sdp
Supported: norefersub

SDP PARAMETERS

c= IN IP6 5055::ccc:ddd:aaa:bbb
 m= audio 6654 RTP/AVP 97
 a= rtpmap:97 AMR
 a= rtcp:6655
 m= application 6655 udp TBCP
 a= fmp: TBCP queuing=1;tb_priority=2;timestamp=1
 m= video 0 RTP/AVP 99
 m= message 0 TCP/MSRP *

10. SIP 200 "OK" response (from SIP/IP Core A to PoC Client A)

The PoC specific elements are the same as in the previous message.

11. SIP ACK request (from PoC Client A to SIP/IP Core A)
12. SIP ACK request (from SIP/IP Core A to PoC Server A)
13. SIP ACK request (from PoC Server A to SIP/IP Core A)
14. SIP ACK request (from SIP/IP Core A to SIP/IP Core X)
15. SIP ACK request (from SIP/IP Core X to PoC Server X)

F.18.2 Backward compatibility towards terminating Participating PoC Function

This subclause describes the PoC Session invitation message flow when the PoC Server X performing the Controlling PoC Function invites to a PoC Session a PoC Client B which is served by the PoC Server B performing the Participating PoC Function which is compliant only to the PoC version 1.0 specification.

The PoC Client B does not request anonymity.

The PoC Server B stays in the Media path.

The flow is as shown in Figure 34 "*Backward compatibility with the PoC Server performing the terminating Participating PoC Function compliant only to the PoC version 1.0 specification*". The SIP 100 "Trying" responses to SIP INVITE requests are not shown in the figure.

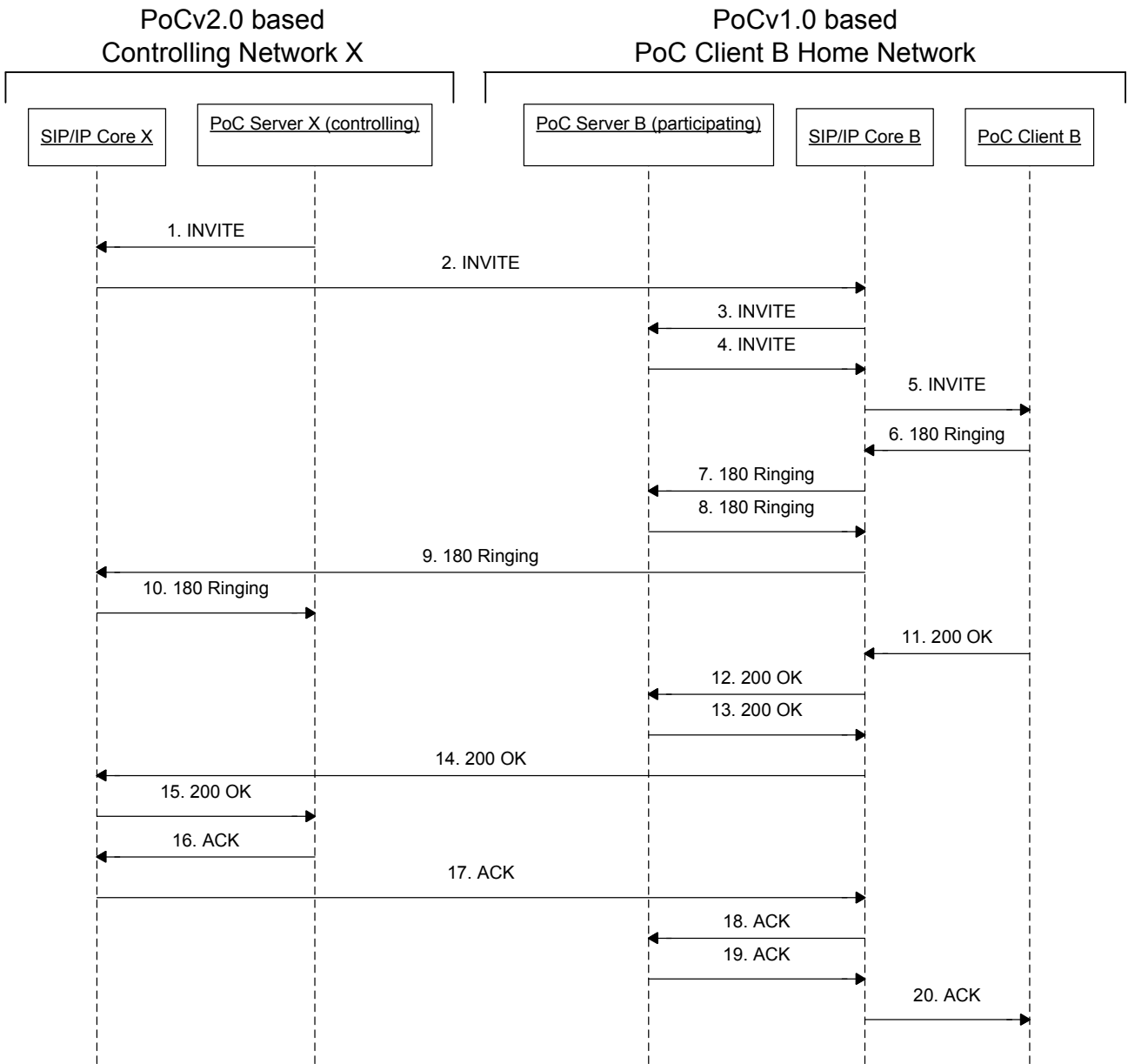

Figure 34: Backward compatibility with the PoC Server performing the terminating Participating PoC Function compliant only to the PoC version 1.0 specification

1. SIP INVITE request (from PoC Server X to SIP/IP Core X)

Request-URI sip:PoC-UserB@networkB.net

SIP HEADERS

P-Asserted-Identity: "PoC User A" <sip:PoC-UserA@networkA.net>
Accept-Contact: *,+g.poc.talkburst; require;explicit
User-Agent: PoC-serv/OMA2.0
Referred-By: "PoC User A" <sip:PoC-UserA@networkA.net>
Contact: <sip:PoC-SessionABCDEF@PoC-ServerX.networkX.net;session=1-1>;+g.poc.talkburst; isfocus
Supported: 100rel,norefersub,timer
Session-Expires: 1800
Allow: INVITE,ACK,CANCEL,BYE,PRACK,UPDATE,REFER,MESSAGE,OPTIONS
Subject: Let's talk
Alert-Info: <http://publicweb.networkB.net/users/PoC-UserA@networkA.net/myFavouriteRingingTone.wav>
Call-Info: <http://publicweb.networkB.net/users/PoC-UserA@networkA.net/myOwnPicture.jpg>;purpose=icon

SDP PARAMETERS

Content-Type: application/sdp

c= IN IP6 5777::eee:fff:aaa:bbb
a= poc-qoe:professionnal
m= audio 53456 RTP/AVP 97 98
a= rtpmap:97 AMR
a= rtpmap:98 EVRC/8000
a= rtcp:53080
i= speech
a= label:ll
a= a=upcc:0
m= application 50000 udp TBCP
a= fmp: TBCP queuing=1; tb_priority=2; timestamp=1;multimedia=1;local_grant=1
a= floorid:0 mstrm:ll kk
m= video 7566 RTP/AVP 99
a= rtpmap:99 MP4V-ES
a= label:kk

a= a=upcc:0
m= message 54321 TCP/MSRP *
a= accept-types:message/cpim application/vnd.oma.poc.final-report+xml
 application/vnd.oma.poc.detailed-progress-report+xml
 application/vnd.oma.poc.optimized-progress-report+xml
a= accept-wrapped-types:text/plain
a= path:msrp://[5777::eee:fff:aaa:bbb]:54321/ksdgfjhafdga45sdf2a;tcp
a= max-size:100000000

Included Media Content

Content-Type: text/directory;profile="vcard";charset=UTF-8

 begin:vcard
 fn:John P. Smith
 n:Smith;John;Peter;Dr.;MBA
 EMAIL:TYPE=internet:POC-UserB@networkA.net
 version:3.0
 end:vcard

Invited parties identity information

Content-Disposition: recipient-list-history;handling="optional"

Content-Type: application/resource-lists+xml

```

<?xml version="1.0" encoding="UTF-8"?>
<resource-lists
  xmlns="urn:ietf:params:xml:ns:resource-lists"
  xmlns:cc="urn:ietf:params:xml:ns:copycontrol"
>
  <list>
    <entry uri="sip:PoC-UserB@networkB.com" cc:copyControl="to"
    cc:anonymize="true"/>
  </list>
</resource-lists>
  
```

2. SIP INVITE request (from SIP/IP Core X to SIP/IP Core B)

The PoC specific elements are the same as in the previous message.

3. SIP INVITE request (from SIP/IP Core B to PoC Server B)

The PoC specific elements are the same as in the previous message.

4. SIP INVITE request (from PoC Server B to SIP/IP Core B)

Request-URI sip:PoC-UserB@networkB.net

SIP HEADERS

P-Asserted-Identity: "PoC User A" <sip:PoC-UserA@networkA.net>

Accept-Contact: *,+g.poc.talkburst; require;explicit

User-Agent: PoC-serv/OMA1.0

Contact: <sip:PoC-SessionABCDEF@PoC_ServerB.networkB.net;session=1-1>;+g.poc.talkburst;isfocus

Supported: norefersub,timer

Session-Expires: 1800

Answer-Mode: Manual;Require

Allow: INVITE,ACK,CANCEL,BYE,PRACK,UPDATE,REFER

Content-Type: application/sdp

SDP PARAMETERS

c= IN IP6 6033::ddd:ccc:aaa:bbb

m= audio 63776 RTP/AVP 98

a= rtpmap:98 EVRC/8000

a= rtcp:63090

m= application 63090 udp TBCP

a= fmp: TBCP queuing=1;tb_priority=2;timestamp=1

5. SIP INVITE request (from SIP/IP Core B to PoC Client B)

The PoC specific elements are the same as in the previous message.

6. SIP 180 "Ringing" response (from PoC Client B to SIP/IP Core B)

SIP HEADERS

P-Preferred-Identity: "PoC User B" <sip:PoC-UserB@networkB.net>
Require: timer
Server: PoC-client/OMA1.0
Contact: <sip:PoC-ClientB.networkB.net>;+g.poc.talkburst
Allow: INVITE,ACK,CANCEL,BYE,REFER

7. SIP 180 "Ringling" response (from SIP/IP Core B to PoC Server B)**SIP HEADERS**

P-Asserted-Identity: "PoC User B" <sip:PoC-UserB@networkB.net>
Require: timer
Server: PoC-client/OMA1.0
Contact: <sip:PoC-ClientB.@networkB.net>; +g.poc.talkburst
Allow: INVITE,ACK,CANCEL,BYE,REFER

8. SIP 180 "Ringling" response (from PoC Server B to SIP/IP Core B)**SIP HEADERS**

P-Asserted-Identity: "PoC User B" <sip:PoC-UserB@networkB.net>
Require: timer
Server: PoC-serv/OMA1.0
Contact: <sip:PoC-ClientB.@networkB.net>; +g.poc.talkburst
Allow: INVITE,ACK,CANCEL,BYE,REFER

9. SIP 180 "Ringling" response (from SIP/IP Core B to SIP/IP Core X)

The PoC specific elements are the same as in the previous message.

10. SIP 180 "Ringling" response (from SIP/IP Core X to PoC Server X)

The PoC specific elements are the same as in the previous message.

11. SIP 200 "OK" response (from PoC Client B to SIP/IP Core B)

SIP HEADERS

P-Preferred-Identity: "PoC User B" <sip:PoC-UserB@networkB.net>
Require: timer
Server: PoC-client/OMA1.0
Contact: <sip:PoC-ClientB.networkB.net>;+g.poc.talkburst
Allow: INVITE,ACK,CANCEL,BYE,REFER
Session-Expires: 1800;refresher=uas
Content-Type: application/sdp

SDP PARAMETERS

c= IN IP6 5569::fff:ddd:aaa:bbb
m= audio 43772 RTP/AVP 98
a= rtpmap:98 EVRC/8000
a= rtcp:53090
m= application 53090 udp TBCP
a= fmp: TBCP queuing=1;tb_priority=2;timestamp=1

12. SIP 200 "OK" response (from SIP/IP Core B to PoC Server B)**SIP HEADERS**

P-Asserted-Identity: "PoC User B" <sip:PoC-UserB@networkB.net>
Require: timer
Server: PoC-client/OMA1.0
Contact: <sip:PoC-ClientB.networkB.net>;+g.poc.talkburst
Allow: INVITE,ACK,CANCEL,BYE,REFER
Session-Expires: 1800;refresher=uas
Content-Type: application/sdp

SDP PARAMETERS

c= IN IP6 5569::fff:ddd:aaa:bbb
m= audio 43772 RTP/AVP 98
a= rtpmap:98 EVRC/8000

a= rtcp:53090
 m= application 53090 udp TBCP
 a= fmp: TBCP queuing=1;tb_priority=2;timestamp=1

13. SIP 200 "OK" response (from PoC Server B to SIP/IP Core B)

SIP HEADERS

P-Asserted-Identity: "PoC User B" <sip:PoC-UserB@networkB.net>
Require: timer
Server: PoC-serv/OMA1.0
Contact: <sip:PoC-ClientB.networkB.net>;+g.poc.talkburst
Allow: INVITE,ACK,CANCEL,BYE,REFER
Session-Expires: 1800;refresher=uas
Content-Type: application/sdp

SDP PARAMETERS

c= IN IP6 6033::ddd:ccc:aaa:bbb
 m= audio 55886 RTP/AVP 98
 a= rtpmap:98 EVRC/8000
 a= rtcp:44229
 m= application 44229 udp TBCP
 a= fmp: TBCP queuing=1;tb_priority=2;timestamp=1
 m= video 0 RTP/AVP 99
 m= message 0 TCP/MSRP *

14. SIP 200 "OK" response (from SIP/IP Core B to SIP/IP Core X)

The PoC specific elements are the same as in the previous message.

15. SIP 200 "OK" response (from SIP/IP Core X to PoC Server X)

The PoC specific elements are the same as in the previous message.

16. SIP ACK request (from PoC Server X to SIP/IP Core X)

17. SIP ACK request (from SIP/IP Core X to SIP/IP Core B)

18. SIP ACK request (from SIP/IP Core B to PoC Server B)

19. SIP ACK request (from PoC Server B to SIP/IP Core B)
20. SIP ACK request (from SIP/IP Core B to PoC Client X)

F.19 Discrete Media in a SIP MESSAGE request

This subclause shows an example of how one Participant sends a Discrete Media in a SIP MESSAGE request to other Participants.

F.19.1 Originating flow

This subclause describes the Discrete Media in a SIP MESSAGE request message flow between the PoC Client A participating in the PoC Session Q and the PoC Server X performing the Controlling PoC Function of the PoC Session Q. The flow also contains the request for the final delivery report using Instant Message Delivery Notification (IMDN).

The PoC User A negotiated anonymity in the PoC Session establishment.

The PoC Client sends the SIP MESSAGE request inside the SIP dialog of the PoC Session.

The PoC Server A is a SIP B2BUA in the PoC Session Q.

The flow is as shown in Figure 35 "PoC Client A sends a Discrete Media in a SIP MESSAGE request".

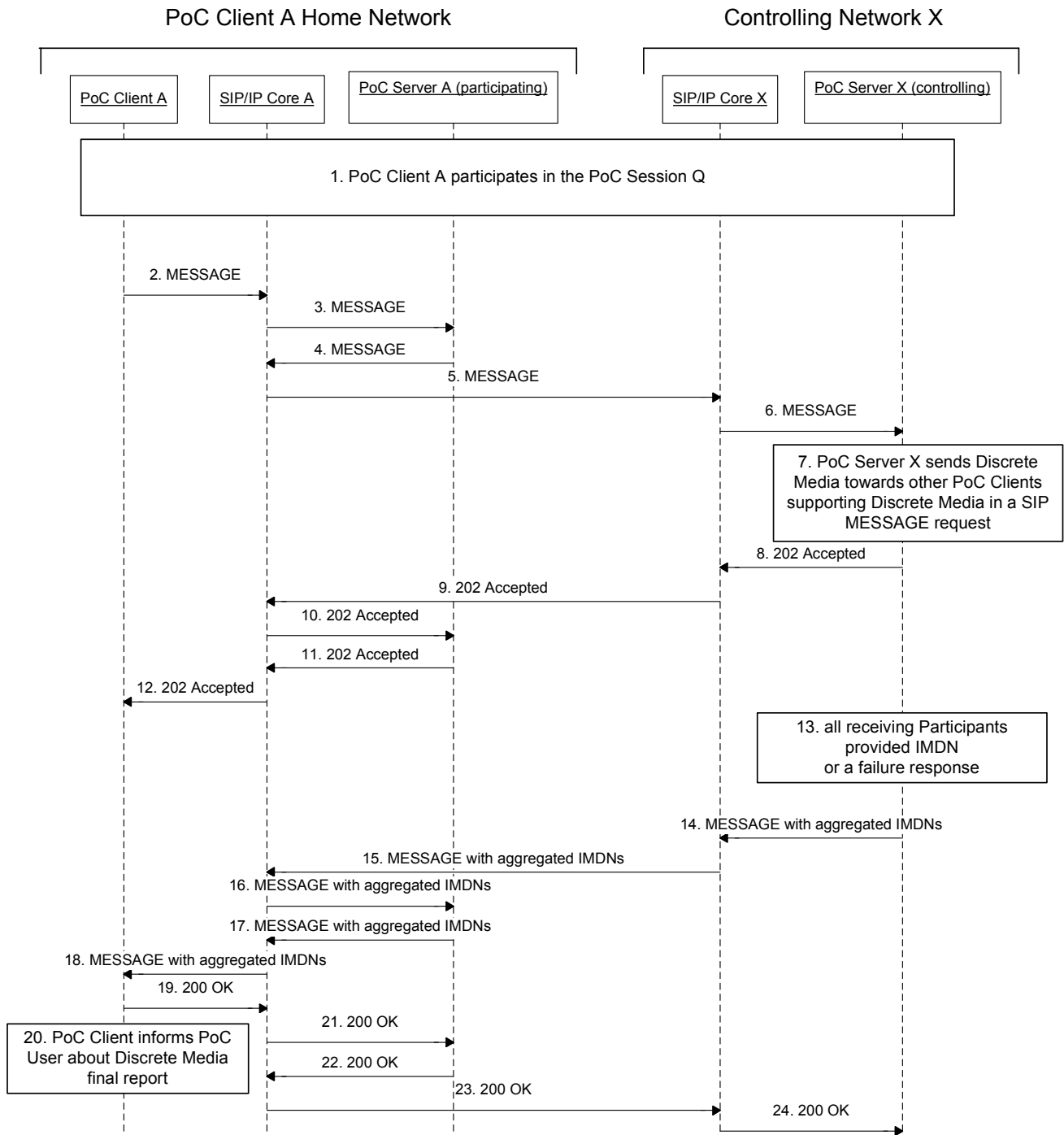

Figure 35: Client A sends a Discrete Media in a SIP MESSAGE request

1. The PoC Client A participates in the PoC Session Q.
2. SIP MESSAGE request (from PoC Client A to SIP/IP Core A)

Request-URI sip:PoCSessionQ%networkX.net@networkA.net

SIP HEADERS

P-Preferred-Identity: "PoC User A" <sip:PoC-UserA@networkA.net>
Content-Type: message/cpim
User-Agent: PoC-client/OMA2.0 vendorOfPoCClientA
Privacy Id

message/cpim MIME BODY

NS: imdn <urn:ietf:params:imdn>
imdn.Disposition-Notification: positive-delivery, negative-delivery
imdn.Message-ID: fgahlghj-PoC-UserA@networkA.net
DateTime: 2006-04-04T12:16:49-05:00

Content-Type text/plain;charset=utf-8

Hello, how are you?

3. SIP MESSAGE request (from SIP/IP Core A to PoC Server A)

Request-URI sip:PoCSessionQ%%networkX.net@networkA.net

SIP HEADERS

P-Asserted-Identity: "PoC User A" <sip:PoC-UserA@networkA.net>
Content-Type: message/cpim
User-Agent: PoC-client/OMA2.0 vendorOfPoCClientA
Privacy Id

message/cpim MIME BODY

NS: imdn <urn:ietf:params:imdn>
imdn.Disposition-Notification: positive-delivery, negative-delivery
imdn.Message-ID: fgahlghj-PoC-UserA@networkA.net
DateTime: 2006-04-04T12:16:49-05:00

Content-Type text/plain;charset=utf-8

Hello, how are you?

4. SIP MESSAGE request (from PoC Server A to SIP/IP Core A)

Request-URI sip:PoCSessionQ@networkX.net

SIP HEADERS

P-Asserted-Identity: "PoC User A" <sip:PoC-UserA@networkA.net>

Content-Type: message/cpim

User-Agent: PoC-serv/OMA2.0 vendorOfPoCServerA

Privacy Id

message/cpim MIME BODY

NS: imdn <urn:ietf:params:imdn>

imdn.Disposition-Notification: positive-delivery, negative-delivery

imdn.Message-ID: fgahlghj-PoC-UserA@networkA.net

DateTime: 2006-04-04T12:16:49-05:00

Content-Type text/plain;charset=utf-8

Hello, how are you?

5. SIP MESSAGE request (from SIP/IP Core A to SIP/IP Core X)

The PoC specific elements are the same as in the previous message.

6. SIP MESSAGE request (from SIP/IP Core X to PoC Server X)

The PoC specific elements are the same as in the previous message.

7. PoC Server sends a Discrete Media in a SIP MESSAGE request to each Participant whose PoC Client supports the Discrete Media in a SIP MESSAGE request.

8. SIP 202 "Accepted" response (from PoC Server X to SIP/IP Core X)

SIP HEADERS

Server: PoC-serv/OMA2.0 vendorOfPoCServerX

9. SIP 202 "Accepted" response (from SIP/IP Core X to SIP/IP Core A)

The PoC specific elements are the same as in the previous message.

10. SIP 202 "Accepted" response (from SIP/IP Core A to PoC Server A)

The PoC specific elements are the same as in the previous message.

11. SIP 202 "Accepted" response (from PoC Server A to SIP/IP Core A)**SIP HEADERS**

Server: PoC-serv/OMA2.0 vendorOfPoCServerA

12. SIP 202 "Accepted" response (from SIP/IP Core A to PoC Client A)

The PoC specific elements are the same as in the previous message.

13. The PoC Server waits until reception of all the IMDNs or until timeout expires.**14. SIP MESSAGE request with aggregated IMDSs (from PoC Server X to SIP/IP Core X)**

Request-URI sip:PoC-UserA@networkA.net

SIP HEADERS

P-Asserted-Identity: sip:PoCSessionQ@networkX.net

Content-Type: message/cpim

User-Agent: PoC-serv/OMA2.0 vendorOfPoCServerX

message/cpim MIME BODY

NS: imdn <urn:ietf:params:imdn>

imdn.Message-ID: r4tgwg45-PoCSessionQ@networkX.net

Content-Type multipart/mixed;boundary="imdn-boundary"

--imdn-boundary

Content-Type message/imdn+xml

Content-Disposition: Notification

```

<?xml version="1.0" encoding="UTF-8"?>
<imdn xmlns="urn:ietf:params:xml:ns:imdn">
  <message-id>fgahlghj-PoC-UserA@networkA.net</message-id>
  <recipient-uri>anonymous-5@anonymous.invalid</recipient-uri>
  <datetime>2006-04-04T12:16:49-05:00</datetime>
  <disposition>
    <delivery/>
  </disposition>
  <status>
    <delivered/>
  </status>
</imdn>

```

--imdn-boundary

Content-Type message/imdn+xml

Content-Disposition: Notification

```

<?xml version="1.0" encoding="UTF-8"?>
<imdn xmlns="urn:ietf:params:xml:ns:imdn">
  <message-id>fgahlghj-PoC-UserA@networkA.net</message-id>
  <recipient-uri>anonymous-3@anonymous.invalid</recipient-uri>
  <datetime>2006-04-04T12:16:49-05:00</datetime>
  <disposition>
    <delivery/>
  </disposition>
  <status>
    <failed/>
  </status>
</imdn>

```

--imdn-boundary--

15. SIP MESSAGE request with aggregated IMDSs (from SIP/IP Core X to SIP/IP Core A)

The PoC specific elements are the same as in the previous message.

16. SIP MESSAGE request with aggregated IMDSs (from SIP/IP Core A to PoC Server A)

The PoC specific elements are the same as in the previous message.

17. SIP MESSAGE request with aggregated IMDSs (from PoC Server A to SIP/IP Core A)

Request-URI sip:PoC-UserA@networkA.net

SIP HEADERS

P-Asserted-Identity: sip:PoCSessionQ%networkX.net@networkA.net

Content-Type: message/cpim

User-Agent: PoC-serv/OMA2.0 vendorOfPoCServerA

message/cpim MIME BODY

NS: imdn <urn:ietf:params:imdn>

imdn.Message-ID: r4tgwg45-PoCSessionQ@networkX.net

Content-Type multipart/mixed;boundary="imdn-boundary"

--imdn-boundary

Content-Type message/imdn+xml

Content-Disposition: notification

```
<?xml version="1.0" encoding="UTF-8"?>
<imdn xmlns="urn:ietf:params:xml:ns:imdn">
  <message-id>fgahlghj-PoC-UserA@networkA.net</message-id>
  <recipient-uri>anonymous-5@anonymous.invalid</recipient-uri>
  <datetime>2006-04-04T12:16:49-05:00</datetime>
  <disposition>
    <delivery/>
  </disposition>
  <status>
    <delivered/>
  </status>
```

```

</imdn>

--imdn-boundary
Content-Type      message/imdn+xml
Content-Disposition: notification

<?xml version="1.0" encoding="UTF-8"?>
<imdn xmlns="urn:ietf:params:xml:ns:imdn">
  <message-id>fgahlghj-PoC-UserA@networkA.net</message-id>
  <recipient-uri>anonymous-3@anonymous.invalid</recipient-uri>
  <datetime>2006-04-04T12:16:49-05:00</datetime>
  <disposition>
    <delivery/>
  </disposition>
  <status>
    <failed/>
  </status>
</imdn>

--imdn-boundary--

```

18. SIP MESSAGE request with aggregated IMDNs (from SIP/IP Core A to PoC Client A)

The PoC specific elements are the same as in the previous message.

19. SIP "200" response (from PoC Client A to SIP/IP Core A)

SIP HEADERS

```

Server:          PoC-client/OMA2.0 vendorOfPoCClientA
P-Preferred-Identity: sip:PoC-UserA@networkA.net

```

20. The PoC Client A informs the PoC User A about the incoming IMDNs.

21. SIP "200" response (from SIP/IP Core A to PoC Server A)

SIP HEADERS

```

Server:          PoC-client/OMA2.0 vendorOfPoCClientA
P-Asserted-Identity: sip:PoC-UserA@networkA.net

```

22. SIP "200" response (from PoC Server A to SIP/IP Core A)**SIP HEADERS**

Server: PoC-serv/OMA2.0 vendorOfPoCServerA

P-Asserted-Identity: sip:PoC-UserA@networkA.net

23. SIP "200" response (from SIP/IP Core A to SIP/IP Core X)

The PoC specific elements are the same as in the previous message.

24. SIP "200" response (from SIP/IP Core X to PoC Server X)

The PoC specific elements are the same as in the previous message.

F.19.2 Terminating flow

This subclause describes the Discrete Media in a SIP MESSAGE request message flow between the PoC Server X performing the Controlling PoC Function of the PoC Session Q and the PoC Client B participating in the PoC Session Q.

The PoC Client B is receiving the Discrete Media in a SIP MESSAGE request sent by PoC Client A.

The PoC User A and PoC User B negotiated anonymity in the PoC Session establishment.

The PoC Server B is a SIP B2BUA in the PoC Session Q.

The flow is as shown in Figure 36 "PoC Client B receives the Discrete Media in a SIP MESSAGE request".

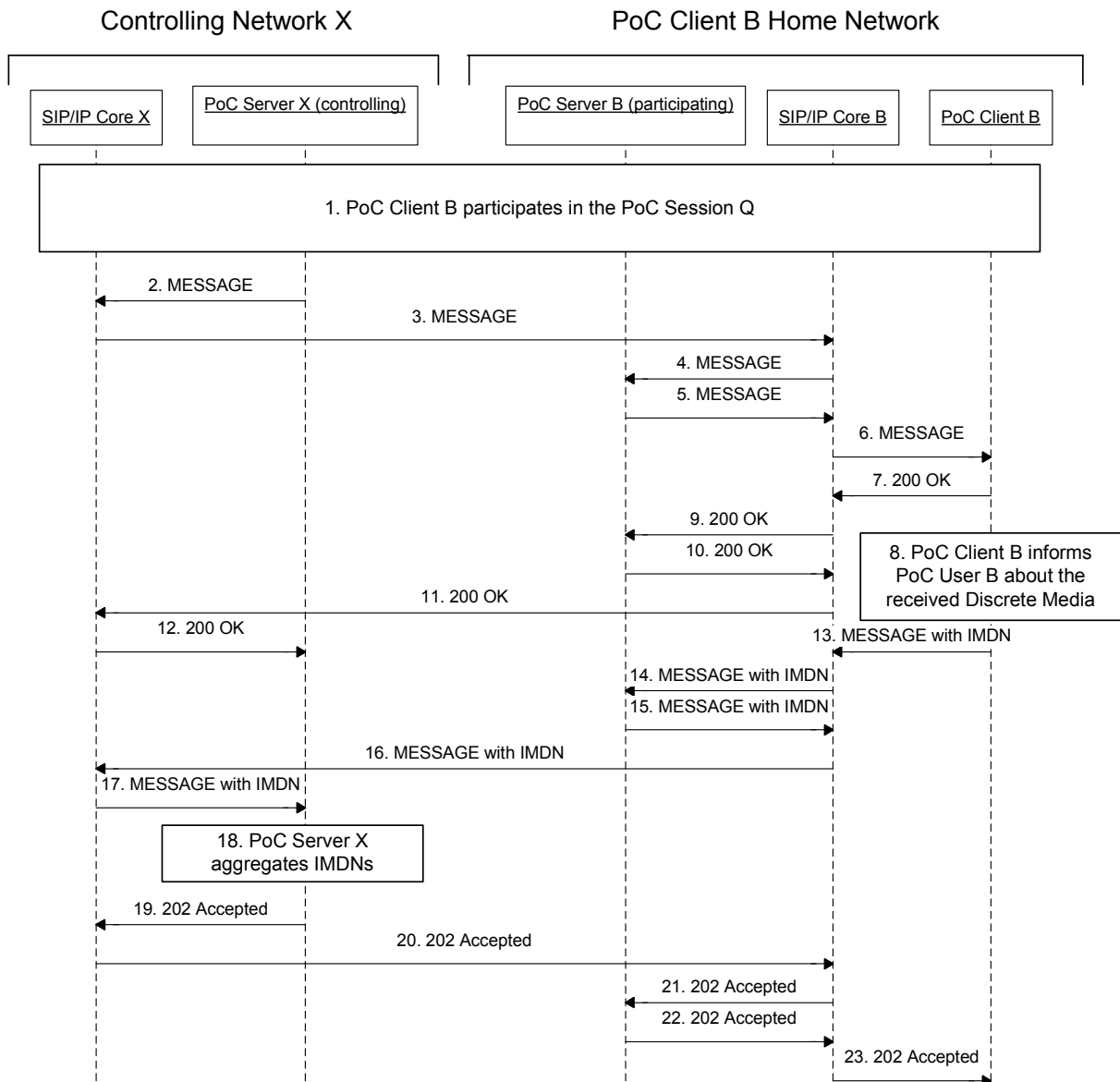

Figure 36: PoC Client B receives the Discrete Media in a SIP MESSAGE request

1. The PoC Client B participates in the PoC Session Q.
2. SIP MESSAGE request (from PoC Server X to SIP/IP Core X)

Upon reception of the Discrete Media in a SIP MESSAGE request from the PoC Client A, the PoC Server X sends a SIP MESSAGE request to SIP/IP Core X for each PoC Client B which supports the Discrete Media in a SIP MESSAGE request.

Request-URI sip:PoC-UserB@networkB.net

SIP HEADERS

P-Asserted-Identity: sip:PoCSessionQ@networkX.net
Content-Type: message/cpim
User-Agent: PoC-serv/OMA2.0 vendorOfPoCServerX
Referred-By: sip:anonymous-1@anonymous.invalid

**message/cpim MIME
 BODY**

NS: imdn <urn:ietf:params:imdn>
imdn.Disposition-Notification: positive-delivery, negative-delivery
imdn.Message-ID: fgahlghj-PoC-UserA@networkA.net
DateTime: 2006-04-04T12:16:49-05:00

Content-Type text/plain;charset=utf-8

Hello, how are you?

3. SIP MESSAGE request (from SIP/IP Core X to SIP/IP Core B)

The PoC specific elements are the same as in the previous message.

4. SIP MESSAGE request (from SIP/IP Core B to PoC Server B)

The PoC specific elements are the same as in the previous message.

5. SIP MESSAGE request (from PoC Server B to SIP/IP Core B)

Request-URI sip:PoC-UserB@networkB.net

SIP HEADERS

P-Asserted-Identity: sip:PoCSessionQ%%networkX.net@networkB.net
Content-Type: message/cpim
User-Agent: PoC-serv/OMA2.0 vendorOfPoCServerB
Referred-By: sip:anonymous-1@anonymous.invalid

**message/cpim MIME
 BODY**

NS: imdn <urn:ietf:params:imdn>
imdn.Disposition-Notification: positive-delivery, negative-delivery

imdn.Message-ID: fgahlgjh-PoC-UserA@networkA.net
DateTime: 2006-04-04T12:16:49-05:00
Content-Type text/plain;charset=utf-8

Hello, how are you?

6. SIP MESSAGE request (from SIP/IP Core B to PoC Client B)

Request-URI sip:PoC-UserB@networkB.net

SIP HEADERS

Content-Type: message/cpim
User-Agent: PoC-serv/OMA2.0 vendorOfPoCServerB
P-Asserted-Identity: sip:PoCSessionQ% %networkX.net@networkB.net
Referred-By: sip:anonymous-1@anonymous.invalid

message/cpim MIME BODY

NS: imdn <urn:ietf:params:imdn>
imdn.Disposition-Notification: positive-delivery, negative-delivery
imdn.Message-ID: fgahlgjh-PoC-UserA@networkA.net
DateTime: 2006-04-04T12:16:49-05:00
Content-Type text/plain;charset=utf-8

Hello, how are you?

7. SIP "200" response (from PoC Client B to SIP/IP Core B)

SIP HEADERS

Server: PoC-client/OMA2.0 vendorOfPoCClientB
P-Preferred-Identity: sip:PoC-UserB@networkB.net

8. The PoC Client B informs the PoC User B about the incoming Discrete Media in a SIP MESSAGE request.
9. SIP "200" response (from SIP/IP Core B to PoC Server B)

SIP HEADERS

Server: PoC-client/OMA2.0 vendorOfPoCClientB
P-Asserted-Identity: sip:PoC-UserB@networkB.net

10. SIP "200" response (from PoC Server B to SIP/IP Core B)

SIP HEADERS

Server: PoC-serv/OMA2.0 vendorOfPoCServerB
P-Asserted-Identity: sip:PoC-UserB@networkB.net

11. SIP "200" response (from SIP/IP Core B to SIP/IP Core X)

The PoC specific elements are the same as in the previous message.

12. SIP "200" response (from SIP/IP Core X to PoC Server X)

The PoC specific elements are the same as in the previous message.

13. SIP MESSAGE request with instant message delivery notification (from PoC Client B to SIP/IP Core B)

Request-URI sip:PoCSessionQ% %networkX.net@networkB.net

SIP HEADERS

Content-Type: message/cpim
P-Preferred-Identity: sip:PoC-UserB@networkB.net
User-Agent: PoC-client/OMA2.0 vendorOfPoCClientB
Privacy: id

message/cpim MIME BODY

NS: imdn <urn:ietf:params:imdn>
imdn.Message-ID: bth523-PoC-UserB@networkB.net

Content-Type message/imdn+xml
Content-Disposition: notification

```

<?xml version="1.0" encoding="UTF-8"?>
<imdn xmlns="urn:ietf:params:xml:ns:imdn">
  <message-id>fgahlghj-PoC-UserA@networkA.net</message-id>
  <datetime>2006-04-04T12:16:49-05:00</datetime>
  <disposition>
    <delivery/>
  </disposition>
  <status>
    <delivered/>
  </status>
</imdn>

```

14. SIP MESSAGE request with instant message delivery notification (from SIP/IP Core B to PoC Server B)

Request-URI sip:PoCSessionQ%%networkX.net@networkB.net

SIP HEADERS

Content-Type: message/cpim
P-Asserted-Identity: sip:PoC-UserB@networkB.net
User-Agent: PoC-client/OMA2.0 vendorOfPoCClientB
Privacy: id

message/cpim MIME BODY

NS: imdn <urn:ietf:params:imdn>
imdn.Message-ID: bth523-PoC-UserB@networkB.net

Content-Type message/imdn+xml
Content-Disposition: notification

```

<?xml version="1.0" encoding="UTF-8"?>
<imdn xmlns="urn:ietf:params:xml:ns:imdn">
  <message-id>fgahlghj-PoC-UserA@networkA.net</message-id>
  <datetime>2006-04-04T12:16:49-05:00</datetime>

```

```

    <disposition>
      <delivery/>
    </disposition>
    <status>
      <delivered/>
    </status>
  </imdn>

```

15. SIP MESSAGE request with instant message delivery notification (from PoC Server B to SIP/IP Core B)

Request-URI sip:PoCSessionQ@networkX.net

SIP HEADERS

Content-Type: message/cpim
P-Asserted-Identity: sip:PoC-UserB@networkB.net
User-Agent: PoC-serv/OMA2.0 vendorOfPoCServerB
Privacy id

message/cpim MIME BODY

NS: imdn <urn:ietf:params:imdn>
imdn.Message-ID: bth523-PoC-UserB@networkB.net

Content-Type message/imdn+xml
Content-Disposition: notification

```

<?xml version="1.0" encoding="UTF-8"?>
<imdn xmlns="urn:ietf:params:xml:ns:imdn">
  <message-id>fgahlghj-PoC-UserA@networkA.net</message-id>
  <datetime>2006-04-04T12:16:49-05:00</datetime>
  <disposition>
    <delivery/>
  </disposition>

```

```

<status>
  <delivered/>
</status>
</imdn>

```

16. SIP MESSAGE request with instant message delivery notification (from SIP/IP Core B to SIP/IP Core X)

The PoC specific elements are the same as in the previous message.

17. SIP MESSAGE request with instant message delivery notification (from SIP/IP Core X to PoC Server X)

The PoC specific elements are the same as in the previous message.

18. PoC Server aggregates the instant message delivery notifications and sends the aggregated instant message delivery notification when needed.

19. SIP 202 "Accepted" response (from PoC Server X to SIP/IP Core X)

SIP HEADERS

Server: PoC-serv/OMA2.0 vendorOfPoCServerX

20. SIP 202 "Accepted" response (from SIP/IP Core X to SIP/IP Core B)

The PoC specific elements are the same as in the previous message.

21. SIP 202 "Accepted" response (from SIP/IP Core B to PoC Server B)

The PoC specific elements are the same as in the previous message.

22. SIP 202 "Accepted" response (from PoC Server B to SIP/IP Core B)

SIP HEADERS

Server: PoC-serv/OMA2.0 vendorOfPoCServerB

23. SIP 202 "Accepted" response (from SIP/IP Core B to PoC Client B)

The PoC specific elements are the same as in the previous message.

F.20 The OPTIONS request

This subclause shows examples of how the SIP OPTIONS request is used to read the capabilities and features supported by other functional entities in a PoC Session.

F.20.1 Originating flow

This subclause describes how a PoC Client sends a SIP OPTIONS request within a PoC Session in order to read the capabilities of the PoC Server and what type of features that are available during the ongoing PoC Session.

The flow is valid for any type of PoC Session.

Figure 37 "OPTIONS request, originating flow" shows the message flow when the SIP OPTIONS request is sent during a Pre-arranged PoC Group Session.

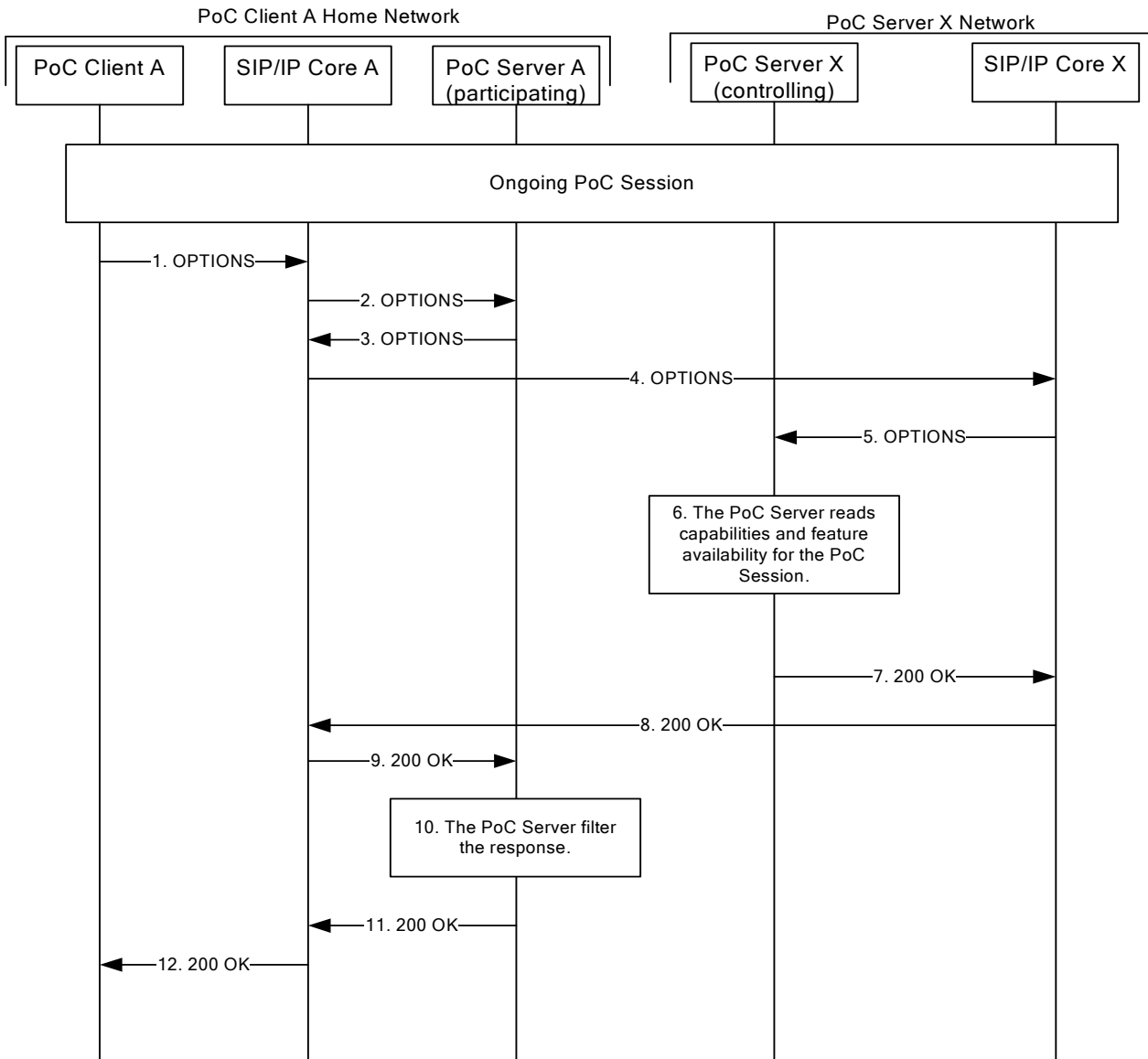

Figure 37: OPTIONS request, originating flow.

The steps of the flow are as follows:

1. SIP OPTIONS request (from PoC Client A to SIP/IP Core A)

The PoC Client A sends a SIP OPTIONS request to SIP/IP Core within the existing SIP dialog.

Request-URI sip:PoC-SessionABCDEF@PoC-ServerA.networkA.net;session=prearranged

SIP HEADERS

Contact: <sip:PoC-ClientA@networkA.net>;+g.poc.talkburst; +g.poc.fdcfo;
+g.poc.discretemedia

2. SIP OPTIONS request (from SIP/IP Core A to PoC Server A)

The SIP/IP Core A sends the SIP OPTIONS request to the PoC Server A.

Request-URI sip:PoC-SessionABCDEF@PoC-ServerA.networkA.net;session=prearranged

SIP HEADERS

Contact: <sip:PoC-ClientA@networkA.net>;+g.poc.talkburst; +g.poc.fdcfo;
+g.poc.discretemedia

3. SIP OPTIONS request (from PoC Server A to SIP/IP Core A)

The PoC Server A forwards the SIP OPTIONS request to the SIP/IP Core A. The SIP OPTIONS request includes the PoC Session Identity in the Request-URI.

Request-URI sip: PoC-SessionABCDEF@PoC-ServerX.networkX.net;session=prearranged

SIP HEADERS

Contact: <sip:PoC-SessionABCDEF@PoC-ServerA.networkA.net>;+g.poc.talkburst;
+g.poc.fdcfo; +g.poc.discretemedia; b2bua

4. SIP OPTIONS request (from SIP/IP Core A to SIP/IP Core X)

The SIP/IP Core A forwards the SIP OPTIONS request to the SIP/IP Core X.

The message contains the same information as between the PoC Server A to SIP/IP Core A as described in step 3.

5. SIP INVITE request (from SIP/IP Core X to PoC Server X)

The SIP/IP Core X forwards the SIP INVITE request to the PoC Server X.

The message contains the same information as between the SIP/IP Core A to SIP/IP Core X as described in step 4.

6. The PoC Server X (controlling) determines what capabilities to return in the SIP 200 "OK" response to the SIP OPTIONS request based on:

- the PoC Group policy for allowing Media Streams in a PoC Session;
- responses to SIP OPTIONS requests received from other Participants in the PoC Session if responses to SIP OPTIONS requests are available to the PoC Server, i.e. features or Media Types not supported by all or a majority of the participants are not included in the SIP 200 "OK";
- feature tags received from other Participants during PoC Session establishment; and,

- the PoC Server X's (controlling) own capabilities.

7. SIP 200 "OK" response (from PoC Server X to SIP/IP Core X)

The PoC Server X sends the SIP 200 "OK" response to the SIP/IP Core X.

In this case the PoC User A at the PoC Client A can use PoC Speech, Video, Audio, Discrete Media without Media Burst Control, Full Duplex Call Follow-on Proceed and send Discrete Media in a SIP MESSAGE request and expect that one or more other Participant in the PoC Session has the same capability.

Additional the PoC User A can use queuing, priority (max priority 1), timestamp Media Burst requests and local grant. The Media Burst Control Scheme "random" is in use at the moment.

SIP HEADERS

Contact: <sip:PoC-SessionABCDEF@PoC-ServerX.networkX.net;session=prearranged>;+g.poc.talkburst;isfocus;+g.poc.fdcfo; +g.poc.discretedia

SDP PARAMETERS

```

c=          IN IP6 9666::eee: aaa:bbb:fff
a=          poc-qoe:premium
m=          audio 0 RTP/AVP 91 92
a=          rtpmap:91 EVRC/8000
a=          rtpmap: 92 AMR/8000
i=          speech
a=          label:aa
m=          application 0 udp TBCP
a=          fmtp:TBCP queuing=1; tb_priority=1; timestamp=1; multimedia=1;
            mbc_scheme="random"; local_grant=1;
a=          floorid:0 mstrm:aa bb cc
m=          video 0 RTP/AVP 93
a=          rtpmap:93 MP4V-ES
a=          label:bb
a=          upcc:0
a=          recvonly
m=          audio 0 RTP/AVP 94 95 96 97
a=          rtpmap:94 pcma/8000
a=          rtpmap:95 pcmu/8000

```

```

a=          rtpmap:96 ilbc/8000
a=          rtpmap:97 amrwb/16000
a=          message 0 TCP/MSRP *
a=          accept-types:message/cpim application/vnd.oma.poc.final-report+xml
           application/vnd.oma.poc.detailed-progress-report+xml
           application/vnd.oma.poc.optimized-progress-report+xml
a=          accept-wrapped-types:text/plain
a=          max-size:64000

```

8. SIP 200 "OK" response (from SIP/IP Core X to SIP/IP Core A)

The SIP/IP Core X forwards the SIP 200 "OK" response to the SIP/IP Core A.

The message contains the same information as between the PoC Server X to SIP/IP Core X as described in step 7.

9. SIP 200 "OK" response (from SIP/IP Core A to PoC Server A)

The SIP/IP Core A forwards the SIP 200 "OK" response to the PoC Server A.

The message contains the same information as between the SIP/IP Core X to SIP/IP Core A as described in step 8.

10. The PoC Server A (participating) filters the SIP 200 OK response based on local policy in the PoC Server and the PoC User profile.

In this example the max-size of MSRP message is reduced to 32000 and some codecs are removed e.g. because of a local policy in the PoC Server does not allow larger messages than 32000 or the use of high bandwidth codecs.

11. SIP 200 "OK" response (from PoC Server A to SIP/IP Core A)

The PoC Server A (participating) forwards the SIP 200 "OK" response to the SIP/IP Core A.

SIP HEADERS

Contact: <sip: PoC-SessionABCDEF@PoC-ServerA.networkA.net;session=prearranged
>;+g.poc.talkburst;isfocus; +g.poc.fdcfo; +g.poc.discretedia

SDP PARAMETERS

```

c=          IN IP6 9666::eee: aaa:bbb:fff
a=          poc-qoe:premium
m=          audio 0 RTP/AVP 91 92
a=          rtpmap:91 EVRC/8000
a=          rtpmap: 92 AMR/8000
i=          speech
a=          label:aa
m=          application 0 udp TBCP

```



```

a=          fmp:TB CP queuing=1; tb_priority=1; timestamp=1; multimedia=1;
           mbc_scheme="random"; tb_txbw=64; poc_sess_priority=1; local_grant=1;
           imp_mb_req=0

a=          floorid:0 mstrm:aa bb cc

m=          video 0 RTP/AVP 93

a=          rtpmap:93 MP4V-ES

a=          label:bb

a=          upcc:0

a=          recvonly

m=          audio 0 RTP/AVP 94 95 96

a=          rtpmap:94 pcma/8000

a=          rtpmap:95 pcmu/8000

a=          rtpmap:96 ilbc/8000

a=          message 0 TCP/MSRP *

a=          accept-types:message/cpim application/vnd.oma.poc.final-report+xml
           application/vnd.oma.poc.detailed-progress-report+xml
           application/vnd.oma.poc.optimized-progress-report+xml

a=          accept-wrapped-types:text/plain

a=          max-size:32000

```

12. SIP 200 "OK" response (from SIP/IP Core A to PoC Client A)

The SIP/IP Core A forwards the SIP 200 "OK" response to the PoC Client A.

The message contains the same information as between the PoC Server A to SIP/IP Core A as described in step 11.

F.20.2 Terminating flow

This subclause describes how the Controlling PoC Server sends a SIP OPTIONS request within an ongoing PoC Session in order to read the capability of a Participant in the PoC Session.

The flow is valid for any type of PoC Session.

Figure 38 "*OPTIONS request, originating flow*" shows the message flow when the OPTIONS request is sent during a Pre-arranged PoC Group Session.

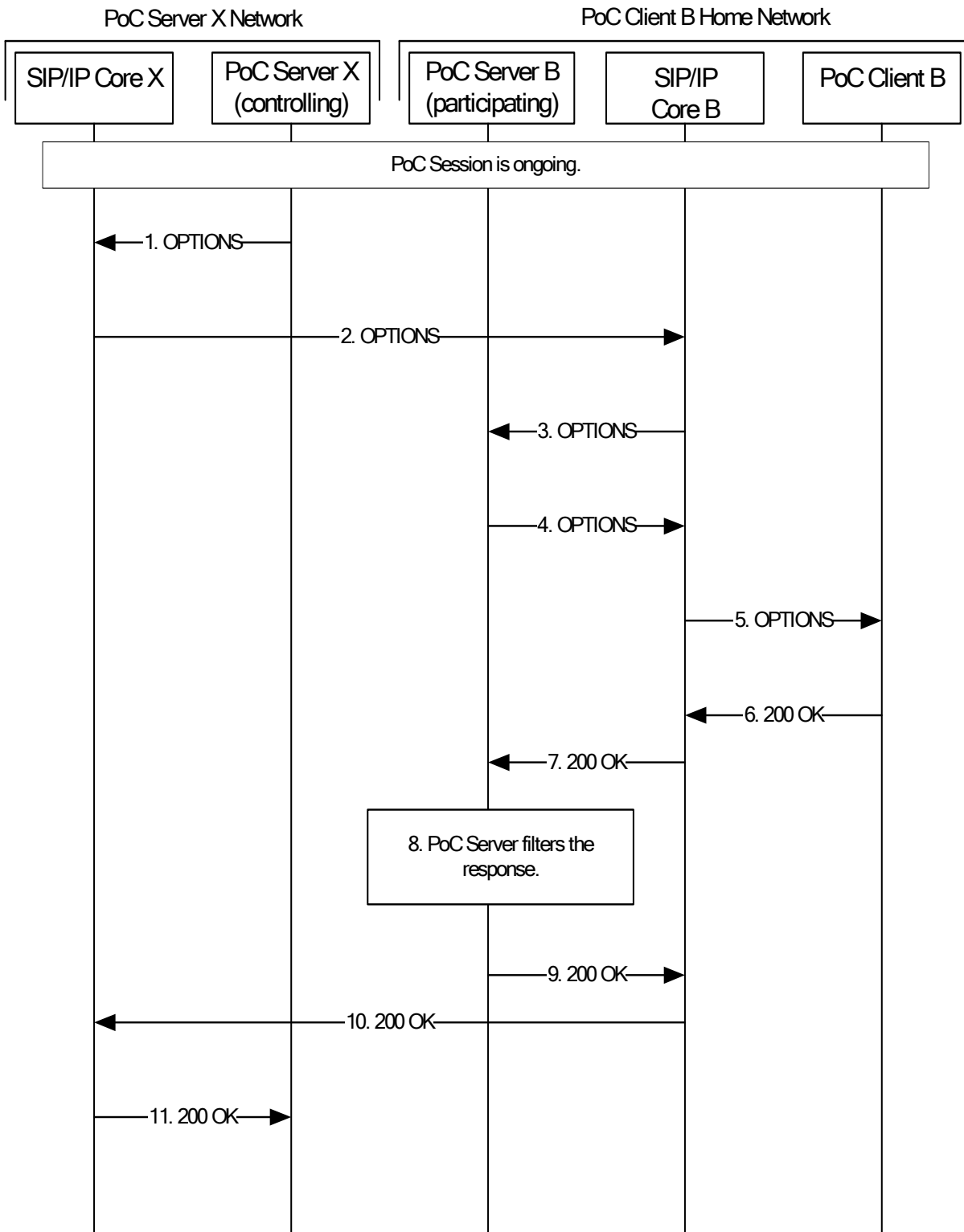

Figure 38: OPTIONS request, terminating flow.

A PoC Client A in an ongoing PoC Session wants to read the capabilities and features that can be used during the ongoing PoC Session.

The steps of the flow are as follows:

1. SIP OPTIONS request (from PoC Server X to SIP/IP Core X)

The PoC Server X sends a SIP OPTIONS request to the SIP/IP Core X within the existing SIP dialog.

Request-URI sip:PoC-UserB@networkB.net

SIP HEADERS

Contact: <sip: PoC-SessionABCDEF@PoC-ServerX.networkX.net;
session=prearranged>;+g.poc.talkburst;isfocus

2. SIP OPTIONS request (from SIP/IP Core X to SIP/IP Core B)

The SIP/IP Core X forwards the SIP OPTIONS request to the SIP/IP Core B.

The message contains the same information as between the PoC Server X to SIP/IP Core X as described in step 1.

3. SIP OPTIONS request (from SIP/IP Core B to PoC Server B)

The SIP/IP Core B sends a SIP OPTIONS request to the PoC Server B.

The message contains the same information as between the SIP/IP Core X to SIP/IP Core B as described in step 2.

4. SIP OPTIONS request (from PoC Server B to SIP/IP Core B)

The PoC Server B forwards the SIP OPTIONS request to the SIP/IP Core B.

Request-URI sip:PoC-UserB@networkB.net

SIP HEADERS

Contact: <sip:PoC-
SessionABCDEF@PoC_ServerB.networkB.net;session=prearranged>;+g.poc.tal
kburst;isfocus;+g.poc.discretedia

5. SIP OPTIONS request (from SIP/IP Core B to PoC Client B)

The SIP/IP Core B forwards the SIP OPTIONS request to the PoC Client B.

The message contains the same information as between the PoC Server B to SIP/IP Core B as described in step 4.

6. SIP 200 "OK" response (from PoC Client B to SIP/IP Core B)

The PoC Client B sends a SIP 200 "OK" response to SIP/IP Core B. The PoC Client B supports PoC Speech and Discrete Media sent in the SIP MESSAGE request, Discrete Media without Media Burst Control (with a max-size of

100000 bytes), queuing of Media Burst requests, priority (using max 2) and local grant.

SIP HEADERS

Contact: <sip:PoC-ClientB.networkB.net>;+g.poc.talkburst; +g.poc.discretemedia

SDP PARAMETERS

```
c=          IN IP6 75555::eee:aaa:fff:bbb
a=          poc-qoe:premium
m=          audio 0 RTP/AVP 98 99
a=          rtpmap:98 EVRC/8000
a          rtpmap: 99 AMR/8000
i=          speech
a=          label:bl
b=          AS:25.4
m=          application 0 udp TBCP
a=          fmp: TBCP queuing=1; tb_priority=2; timestamp=1;multimedia=1;local_grant=1
a=          floorid:0 mstrm:b1
m=          message 0 TCP/MSRP *
a=          accept-types:message/cpim application/vnd.oma.poc.final-report+xml
            application/vnd.oma.poc.detailed-progress-report+xml
            application/vnd.oma.poc.optimized-progress-report+xml
a=          accept-wrapped-types:text/plain
a=          path:msrp://[55555::aaa:bbb:ccc:ddd]:0/kjhd37s2s20w2a;tcp
a=          max-size:100000
```

7. SIP 200 OK response (from SIP/IP Core B to the PoC Server B)

The SIP/IP Core B forwards the SIP 200 "OK" response to the PoC Server B.

The message contains the same information as between the PoC Client B to SIP/IP Core B as described in step 6.

8 The PoC Server B (participating) can filter the 200 "OK" response based on local policy and the PoC Users profile.

In this example the PoC Server B (participating) reduces the message max-size to 64000 bytes of Discrete Media messages e.g. because a local policy in the PoC Server does not allow messages greater than 64000 bytes.

9. SIP 200 "OK" response (from PoC Server B to SIP/IP Core B)

The PoC Server B forwards the SIP 200 "OK" response to SIP/IP Core B.

SIP HEADERS

Contact: <sip:PoC-SessionABCDEF@PoC_ServerB.networkB.net;session=prearranged>;+g.poc.tal
kburst; +g.poc.discretedia

SDP PARAMETERS

c= IN IP6 75555::eee:aaa:fff:bbb
a= poc-qoe:premium
m= audio 0 RTP/AVP 98 99
a= rtpmap:98 EVRC/8000
a rtpmap: 99 AMR/8000
i= speech
a= label:bl
b= AS:25.4
m= application 0 udp TBCP
a= fmtp:TBCP queuing=1; tb_priority=2;
timestamp=1;multimedia=1;local_grant=1;imp_mb_req=1
a= floorid:0 mstrm:b1
m= message 0 TCP/MSRP *
a= accept-types:message/cpim application/vnd.oma.poc.final-report+xml
application/vnd.oma.poc.detailed-progress-report+xml
application/vnd.oma.poc.optimized-progress-report+xml
a= accept-wrapped-types:text/plain
a= path:msrp://[5555::aaa:bbb:ccc:ddd]:0/kjhd37s2s20w2a;tcp
a= max-size:64000

10. SIP 200 OK response (from SIP/IP Core B to the SIP/IP Core X)

The SIP/IP Core B forwards the SIP 200 "OK" response to the SIP/IP Core X.

The message contains the same information as between the PoC Server B to SIP/IP Core B as described in step 9.

11. SIP 200 OK response (from SIP/IP Core X to the PoC Server X)

The SIP/IP Core X forwards the SIP 200 "OK" response to the PoC Server X.

The message contains the same information as between the SIP/IP Core B to the SIP/IP Core X as described in step 10.

F.21 F.X UE PoC Box 1-1 PoC Session establishment On-demand Session

F.21.1 Originating flow – PoC Session Establishment with a UE PoC Box

The signaling sequences in this subclause show the establishment of the 1-1 PoC Session with a UE-PoC Box using on-demand signaling in the originating side. As a prerequisite for the on-demand signaling, PoC Client needs to be registered.

This flow shows the signaling sequence for the Confirmed indication case when the terminating side answers manually and SIP 200 "OK" response is not sent before the SIP 200 "OK" response from the terminating side is received.

QoE Profiles feature is used in this flow. PoC Client A requests Professional QoE Profile for the PoC Session and for his Local QoE Profile.

The flow is as shown in **Figure 9** "*1-1 PoC Session establishment on the originating side using on-demand signaling, establishment with a UE PoC Box*".

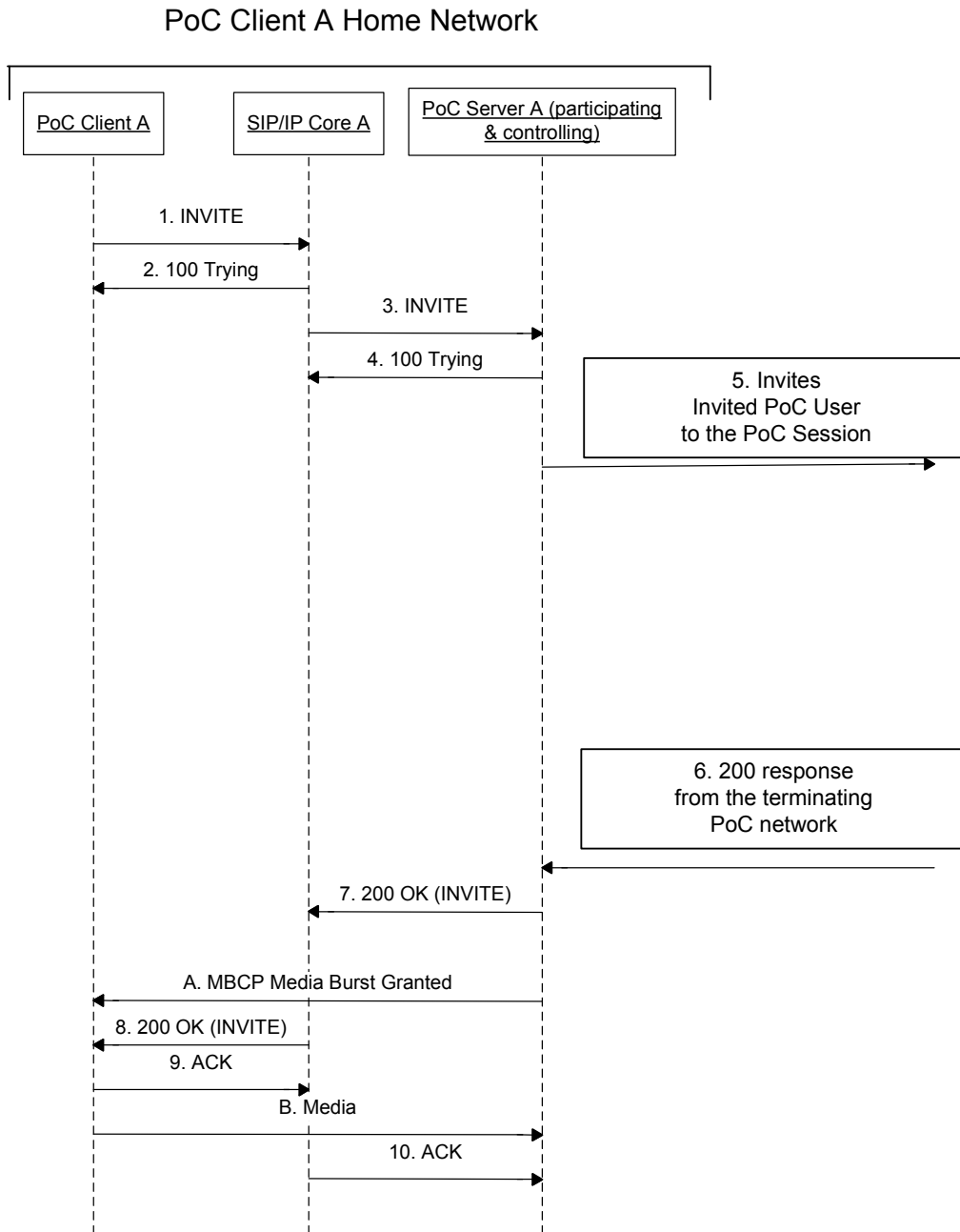

Figure 39: 1-1 PoC Session establishment on the originating side using on-demand signaling, establishment with a UE PoC Box

The steps of the flow are as follows:

1. SIP INVITE request (from PoC Client A to SIP/IP Core A)

The PoC Client A sends a SIP INVITE request to SIP/IP Core A.

Request-URI sip:PoCConferenceFactoryURI.networkA.net

SIP HEADERS

P-Preferred-Identity: "PoC User A" <sip:PoC-UserA@networkA.net>

Accept-Contact: *,+g.poc.talkburst;sip.automata;sip.actor=msg-taker;require;explicit

Accept-Contact: *,+g.poc.talkburst;sip.automata;sip.actor=principal;sip.description="poc recording device";require;explicit

User-Agent: PoC-client/OMA2.0 Acme-Talk5000/v1.01

Privacy: id

Contact: <sip:PoC-ClientA.networkA.net>;+g.poc.talkburst

Supported: Timer

Session-Expires: 1800

Allow: INVITE,ACK,CANCEL,BYE,REFER,OPTIONS,MESSAGE

Require: recipient-list-invite

Content-Type: multipart/mixed

Accept-Language: en

Subject: Message from Alice

SDP PARAMETERS

Content-Type: application/sdp

c= IN IP6 5555::aaa:bbb:ccc:ddd

m= audio 3456 RTP/AVP 97

a= poc-qoe: professional

a= rtpmap:97 AMR

a= rtcp:5560

i= speech

b= AS:25.4

a= label:aa

m= application 2000 udp TBCP

a= fmp:TBCP multimedia=1

a= floorid:0 mstrm:aa

XML MIME BODY

Content-Type: application/resource-lists+xml

Content-Disposition: recipient-list

```
<?xml version="1.0" encoding="UTF-8"?>

<resource-lists xmlns="urn:ietf:params:xml:ns:resource-lists"
  xmlns:xsi="http://www.w3.org/2001/XMLSchema-instance"
  xmlns:cc="urn:ietf:params:xml:ns:copycontrol"
>

  <list>
    <entry uri="sip:PoC-UserB@networkB.com" cc:copyControl="to"
cc:anonymize="true"/>
  </list>
</resource-lists>
```

2. SIP 100 "Trying" response (from SIP/IP Core A to PoC Client A)

The SIP/IP Core A sends a SIP 100 "Trying" response to PoC Client A.

3. SIP INVITE request (from SIP/IP Core A to PoC Server A)

The SIP/IP Core A forwards the SIP INVITE request to the PoC Server A.

Request-URI sip:PoCConferenceFactoryURI.networkA.net

SIP HEADERS

P-Asserted-Identity: "PoC User A" <sip:PoC-UserA@networkA.net>

Accept-Contact: *,+g.poc.talkburst;sip.automata;sip.actor=msg-taker;require;explicit

Accept-Contact: *,+g.poc.talkburst;sip.automata;sip.actor=principal;sip.description="poc recording device";require;explicit

User-Agent: PoC-client/OMA2.0 Acme-Talk5000/v1.01
Privacy: id
Contact: <sip:PoC-ClientA.networkA.net>;+g.poc.talkburst
Supported: timer
Session-Expires: 1800
Allow: INVITE,ACK,CANCEL,BYE,REFER,OPTIONS,MESSAGE
Require: recipient-list-invite
Content-Type: multipart/mixed
Accept-Language: en
Subject: Message from Alice

SDP PARAMETERS

Content-Type: application/sdp

c= IN IP6 5555::aaa:bbb:ccc:ddd
a= poc-qoe:professional
m= audio 3456 RTP/AVP 97
a= rtpmap:97 AMR
a= rtcp:5560
i= speech
b= AS:25.4
a= label:aa
m= application 2000 udp TBCP
a= fmp: TBCP multimedia=1
a= floorid:0 mstrm:aa

XML MIME BODY

Content-Type: application/resource-lists+xml

Content-Disposition: recipient-list

```

<?xml version="1.0" encoding="UTF-8"?>

<resource-lists xmlns="urn:ietf:params:xml:ns:resource-lists"
  xmlns:xsi="http://www.w3.org/2001/XMLSchema-instance"
  xmlns:cc="urn:ietf:params:xml:ns:copycontrol"
>

  <list>
    <entry uri="sip:PoC-UserB@networkB.com" cc:copyControl="to"
      cc:anonymize="true"/>
  </list>

</resource-lists>

```

4. SIP 100 "Trying" response (from PoC Server A to SIP/IP Core A)

The PoC Server A sends a SIP 100 "Trying" response to the SIP/IP Core A.

5. PoC Server A sends SIP INVITE requests towards the Invited PoC Clients

The PoC Server A sends SIP INVITE requests to the Invited PoC Client.

Request-URI sip:PoC-UserB@networkB.net

SIP HEADERS

P-Asserted-Identity: "PoC User A" <sip:PoC-UserA@networkA.net>

Accept-Contact: *,+g.poc.talkburst;sip.automata;sip.actor=msg-taker;require;explicit

Accept-Contact: *,+g.poc.talkburst;sip.automata;sip.actor=principal;sip.description="poc recording device";require;explicit

User-Agent: PoC-serv/OMA2.0

Referred-By: "PoC User A" <sip:PoC-UserA@networkA.net>

Privacy: id

Contact: <sip:PoC-SessionABCDEF@PoC-ServerA.networkA.net;session=1-1>;+g.poc.talkburst;isfocus

Supported: 100rel,timer,norefersub

Session-Expires: 1800

Allow: INVITE,ACK,CANCEL,BYE,PRACK,UPDATE,REFER,MESSAGE,OPTIONS

Subject: Message from Alice

SDP PARAMETERS

Content-Type: application/sdp

c= IN IP6 50555::ccc:ddd:aaa:bbb
a= poc-qoe:professional
m= audio 53456 RTP/AVP 97 98
a= rtpmap:97 AMR
a= rtpmap:98 EVRC/8000
a= rtcp:53080
i= speech
a= label:ll
a= a=upcc:0
m= Application 50000 udp TBCP
a= fmp: TBCP multimedia=1
a= floorid:0 mstrm:ll

**Invited parties
identity
information**

Content-Disposition: recipient-list-history;handling="optional"

Content-Type: application/resource-lists+xml

```
<?xml version="1.0" encoding="UTF-8"?>
<resource-lists
  xmlns="urn:ietf:params:xml:ns:resource-lists"
  xmlns:cc="urn:ietf:params:xml:ns:copycontrol"
>
  <list>
    <entry uri="sip:PoC-UserB@networkB.com" cc:copyControl="to"
cc:anonymize="true"/>
  </list>
```

</resource-lists>

6. PoC Server A receives SIP 200 "OK" response

The first SIP 200 "OK" response is received from the terminating PoC Network.

SIP HEADERS

P-Asserted-Identity: "PoC User B" <sip:PoC-UserB@networkB.net>
Privacy: id
Require: timer
Server: PoC-serv/OMA2.0
Session-Expires: 1800;refresher=uas
Contact: <sip:PoC-SessionABCDEF@PoC-ServerB.networkB.net;b2bua>;+g.poc.talkburst; sip.automata;sip.actor=principal;sip.description="poc recording device"
Accept-Language: en
Content-Type: application/sdp

SDP PARAMETERS

c= IN IP6 99055::fff:aaa:eee:bbb
a= poc-qoe:premium
m= audio 59006 RTP/AVP 97
a= rtpmap:97 AMR
a= Rtcp:50000
i= speech
b= AS:25.4
a= label:uu
a= a=upcc:0
m= application 50000 udp TBCP
a= fntp:TBCP multimedia=1
a= floorid:0 mstrm:uu

7. SIP 200 "OK" response (from PoC Server A to SIP/IP Core A)

The PoC Server A sends a SIP 200 "OK" response to SIP/IP Core A.

SIP HEADERS

P-Asserted-Identity: <sip:PoCConferenceFactoryURI.networkA.net>

Require: timer

Server: PoC-serv/OMA2.0

Session-Expires: 1800;refresher=uac

Contact: <sip:PoC-SessionABCDEF@PoC-ServerA.networkA.net;session=1-1>;+g.poc.talkburst; sip.automata;sip.actor=principal;sip.description="poc recording device";isfocus

Allow: INVITE,ACK,CANCEL,BYE,PRACK,UPDATE,REFER,MESSAGE,OPTIONS

Supported: norefersub

SDP PARAMETERS

c= IN IP6 57777::eee:fff:aaa:bbb

a= poc-qoe:professional

m= audio 57787 RTP/AVP 97

i= speech

a= label:xxx

a= rtpmap:97 AMR

a= Rtcp:57000

m= application 57790 udp TBCP

a= fmp: TBCP multimedia=1

a= floorid:0 mstrm:xxx

A. MBCP Media Burst Granted (PoC Server A to PoC Client A)

The PoC Server A sends MBCP Media Burst Granted message to PoC Client A.

8. SIP 200 "OK" response (from SIP/IP Core A to PoC Client A)

The SIP/IP Core A forwards the SIP 200 "OK" response to PoC Client A.

SIP HEADERS

P-Asserted-Identity: <sip:PoCConferenceFactoryURI.networkA.net>

Require: timer

Server: PoC-serv/OMA2.0

Session-Expires: 1800;refresher=uac

Contact: <sip:PoC-SessionABCDEF@PoC-ServerA.networkA.net;session=1-1>;+g.poc.talkburst; sip.automata;sip.actor=principal;sip.description="poc recording device";isfocus

Allow: INVITE,ACK,CANCEL,BYE,PRACK,UPDATE,REFER,MESSAGE,OPTIONS

Supported: norefersub

SDP PARAMETERS

c= IN IP6 57777::eee:fff:aaa:bbb

a= poc-qoe:professional

m= audio 57787 RTP/AVP 97

i= speech

a= label:xxx

a= rtpmap:97 AMR

a= Rtcp:57000

m= application 57790 udp TBCP

a= fmp: TBCP multimedia=1

a= floorid:0 mstrm:xxx

9. SIP ACK request (from PoC Client A to SIP/IP Core A)

The PoC Client A sends a SIP ACK request to SIP/IP Core A.

B. PoC Client sends RTP Media to PoC Server A

The PoC Client A sends RTP Media packets to PoC Server A.

10. SIP ACK request (from SIP/IP Core A to PoC Server A)

The SIP/IP Core A forwards the SIP ACK request to PoC Server A.

F.21.2 Terminating flow – UE PoC Box Accepts the PoC Session

PoC Server X invites the UE PoC Box B to a PoC Session by sending a SIP INVITE request to the terminating SIP/IP Core.

The signaling sequences in this subclause show the establishment of the 1-1 PoC Session using on-demand signaling in the terminating side when the PoC User has explicitly requested to reach a PoC Box and a UE PoC Box is selected. As a prerequisite for the on-demand signaling, the PoC Client needs to be registered.

This scenario applies for the On-demand PoC Session case.

QoE Profiles feature is used in this flow, QoE Profile assigned to the PoC Session is Professional QoE Profile and PoC Client B is subscribed and selects Premium as Local QoE Profile.

This flow shows the signaling sequence for the session where the PoC User has explicitly requested to reach a PoC Box and a UE PoC Box is selected. The flow is as shown in **Figure 10 "PoC Session invitation with UE PoC Box"**.

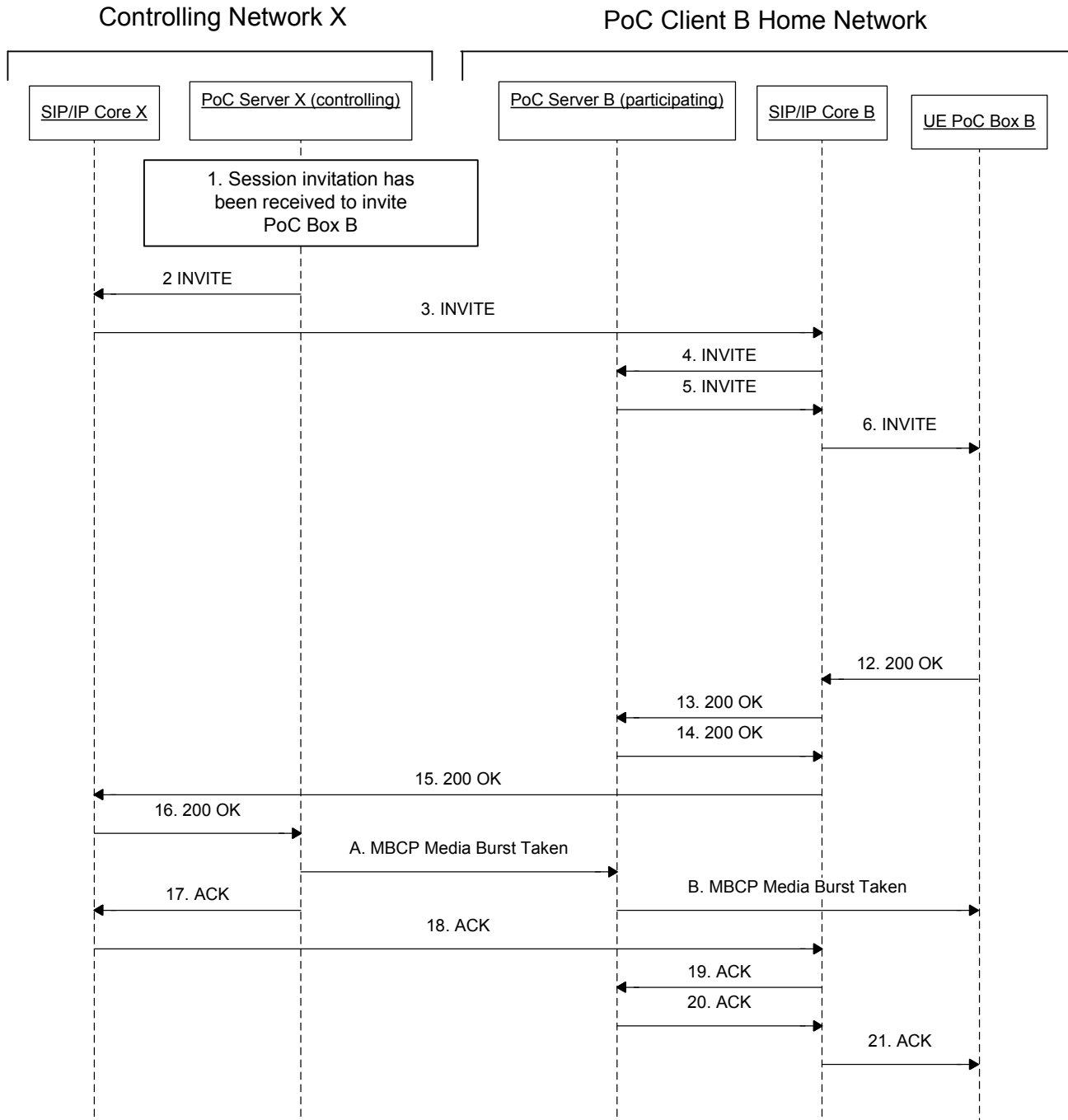

Figure 40 : PoC Session invitation with UE PoC Box

The steps of the flow are as follows:

- 1. Session invitation has been received to invite PoC Box**

2. SIP INVITE request (from the PoC Server X to SIP/IP Core X)

PoC Server X sends the SIP INVITE request to SIP/IP Core X.

Request-URI sip:PoC-UserB@networkB.net

SIP HEADERS

P-Asserted-Identity: "PoC User A" <sip:PoC-UserA@networkA.net>
Accept-Contact: *,+g.poc.talkburst;sip.automata;sip.actor=msg-taker;require;explicit
Accept-Contact: *,+g.poc.talkburst;sip.automata;sip.actor=principal;sip.description="poc recording device";require;explicit
User-Agent: PoC-serv/OMA2.0
Referred-By: "PoC User A" <sip:PoC-UserA@networkA.net>
Privacy: id
Contact: <sip:PoC-SessionABCDEF@PoC-ServerX.networkX.net;session=1-1>;+g.poc.talkburst; isfocus
Supported: 100rel,norefersub,timer
Session-Expires: 1800
Allow: INVITE,ACK,CANCEL,BYE,PRACK,UPDATE,REFER,MESSAGE,OPTIONS
Subject: Message from Alice

SDP PARAMETERS

Content-Type: application/sdp

c= IN IP6 50555::ccc:ddd:aaa:bbb
a= poc-qoe:professional
m= audio 53456 RTP/AVP 97 98
a= rtpmap:97 AMR
a= rtpmap:98 EVRC/8000
a= rtcp:53080
i= speech
a= label:ll
a= a=upcc:0
m= Application 50000 udp TBCP

a= ftmp:TBCP multimedia=1

a= floorid:0 mstrm:ll

Invited parties identity information

Content-Disposition: recipient-list-history;handling="optional"

Content-Type: application/resource-lists+xml

```
<?xml version="1.0" encoding="UTF-8"?>
<resource-lists
  xmlns="urn:ietf:params:xml:ns:resource-lists"
  xmlns:cc="urn:ietf:params:xml:ns:copycontrol"
>
  <list>
    <entry uri="sip:PoC-UserB@networkB.com" cc:copyControl="to"
cc:anonymize="true"/>
  </list>
</resource-lists>
```

3. SIP INVITE request (from SIP/IP Core X to SIP/IP Core B)

SIP/IP Core X forwards the SIP INVITE request to SIP/IP Core B.

Request-URI sip:PoC-UserB@networkB.net

SIP HEADERS

P-Asserted-Identity: "PoC User A" <sip:PoC-UserA@networkA.net>

Accept-Contact: *,+g.poc.talkburst;sip.automata;sip.actor=msg-taker;require;explicit

Accept-Contact: *,+g.poc.talkburst;sip.automata;sip.actor=principal;sip.description="poc recording device";require;explicit

User-Agent: PoC-serv/OMA2.0

Referred-By: "PoC User A" <sip:PoC-UserA@networkA.net>

Privacy: id

Contact: <sip:PoC-SessionABCDEF@PoC-ServerX.networkX.net;session=1-1>;+g.poc.talkburst;isfocus

Supported: 100rel,norefersub,timer
Session-Expires: 1800
Allow: INVITE,ACK,CANCEL,BYE,PRACK,UPDATE,REFER,MESSAGE,OPTIONS
Subject: Message from Alice

SDP PARAMETERS

Content-Type: application/sdp

c= IN IP6 50555::ccc:ddd:aaa:bbb
a= poc-qoe:professsional
m= audio 53456 RTP/AVP 97 98
a= rtpmap:97 AMR
a= rtpmap:98 EVRC/8000
a= rtcp:53080
i= speech
a= label:ll
a= a=upcc:0
m= Application 50000 udp TBCP
a= fmp: TBCP multimedia=1
a= floorid:0 mstrm:ll kk

Invited parties identity information

Content-Disposition: recipient-list-history;handling="optional"
Content-Type: application/resource-lists+xml

```

<?xml version="1.0" encoding="UTF-8"?>
<resource-lists
  xmlns="urn:ietf:params:xml:ns:resource-lists"
  xmlns:cc="urn:ietf:params:xml:ns:copycontrol"
>
  <list>
    <entry uri="sip:PoC-UserB@networkB.com" cc:copyControl="to"
  
```

```

cc:anonymize="true"/>
</list>
</resource-lists>

```

4. SIP INVITE request (from SIP/IP Core B to PoC Server B)

SIP/IP Core B forwards the SIP INVITE request to PoC Server B.

Request-URI sip:PoC-UserB@networkB.net

SIP HEADERS

P-Asserted-Identity: "PoC User A" <sip:PoC-UserA@networkA.net>
Accept-Contact: *,+g.poc.talkburst;sip.automata;sip.actor=msg-taker;require;explicit
Accept-Contact: *,+g.poc.talkburst;sip.automata;sip.actor=principal;sip.description="poc recording device";require;explicit
User-Agent: PoC-serv/OMA2.0
Referred-By: "PoC User A" <sip:PoC-UserA@networkA.net>
Privacy: id
Contact: <sip:PoC-SessionABCDEF@PoC-ServerX.networkX.net;session=1-1>;+g.poc.talkburst;isfocus
Supported: 100rel,norefersub,timer
Session-Expires: 1800
Allow: INVITE,ACK,CANCEL,BYE,PRACK,UPDATE,REFER,MESSAGE,OPTIONS
Subject: Message from Alice

SDP PARAMETERS

Content-Type: application/sdp

```

c= IN IP6 50555::ccc:ddd:aaa:bbb
m= audio 53456 RTP/AVP 97 98
a= poc-qoe:professional
a= rtpmap:97 AMR
a= rtpmap:98 EVRC/8000
a= rtcp:53080

```

i= speech
a= label:ll
a= a=upcc:0
m= Application 50000 udp TBCP
a= fmp: TBCP multimedia=1
a= floorid:0 mstrm:ll

Invited parties identity information

Content-Disposition: recipient-list-history;handling="optional"
Content-Type: application/resource-lists+xml

```

<?xml version="1.0" encoding="UTF-8"?>
<resource-lists
  xmlns="urn:ietf:params:xml:ns:resource-lists"
  xmlns:cc="urn:ietf:params:xml:ns:copycontrol"
>
  <list>
    <entry uri="sip:PoC-UserB@networkB.com" cc:copyControl="to"
cc:anonymize="true"/>
  </list>
</resource-lists>
  
```

5. SIP INVITE request (from PoC Server B to SIP/IP Core B)

PoC Server B sends a SIP INVITE request to SIP/IP Core B.

Request-URI sip:PoC-UserB@networkB.net

SIP HEADERS

P-Asserted-Identity: "PoC User A" <sip:PoC-UserA@networkA.net>

Accept-Contact: *,+g.poc.talkburst;sip.automata;sip.actor=principal;sip.description="poc recording device";require;explicit

User-Agent: PoC-serv/OMA2.0

Privacy: id
Contact: <sip:PoC-SessionABCDEF@PoC_ServerB.networkB.net;session=1-1>;+g.poc.talkburst;isfocus
Supported: norefersub,timer
Session-Expires: 1800
Answer-Mode: Manual;Require
Allow: INVITE,ACK,CANCEL,BYE,PRACK,UPDATE,REFER,MESSAGE,OPTIONS
Subject: Message from Alice

SDP PARAMETERS

c= IN IP6 60333::ddd:ccc:aaa:bbb
a= poc-qoe:professional
m= audio 63776 RTP/AVP 98
a= rtpmap:98 EVRC/8000
a= rtcp:63090
i= speech
a= label:al
m= Application 60000 udp TBCP
a= fmp: TBCP multimedia=1
a= floorid:0 mstrm:al

Invited parties identity information

Content-Disposition: recipient-list-history;handling="optional"
Content-Type: application/resource-lists+xml

```

<?xml version="1.0" encoding="UTF-8"?>
<resource-lists
  xmlns="urn:ietf:params:xml:ns:resource-lists"
  xmlns:cc="urn:ietf:params:xml:ns:copycontrol"
>
  <list>
    <entry uri="sip:anonymous@anonymous.invalid" cc:copyControl="to"
  
```

```

cc:count="2"/>
</list>
</resource-lists>

```

6. SIP INVITE request (from SIP/IP Core B to UE PoC Box B)

SIP/IP Core B forwards the SIP INVITE request to UE PoC Box B.

Request-URI sip:PoC-UserB@networkB.net

SIP HEADERS

Accept-Contact: *;+g.poc.talkburst;sip.automata;sip.actor=principal;sip.description="poc recording device";require;explicit

User-Agent: PoC-serv/OMA2.0

Contact: <sip:PoC-SessionABCDEF@PoC_ServerB.networkB.net;session=1-1>;+g.poc.talkburst;isfocus

Supported: norefersub,timer

Session-Expires: 1800

Answer-Mode: Manual;Require

Allow: INVITE,ACK,CANCEL,BYE,PRACK,UPDATE,REFER,MESSAGE,OPTIONS

Subject: Message from Alice

SDP PARAMETERS

c= IN IP6 60333::ddd:ccc:aaa:bbb

a= poc-qoe:professional

m= audio 63776 RTP/AVP 98

a= rtpmap:98 EVRC/8000

a= rtcp:63090

i= speech

a= label:al

m= Application 60000 udp TBCP

a= fntp:TBCP multimedia=1

a= floorid:0 mstrm:al

Invited parties identity information**Content-Disposition:** recipient-list-history;handling="optional"**Content-Type:** application/resource-lists+xml

```

<?xml version="1.0" encoding="UTF-8"?>
<resource-lists
  xmlns="urn:ietf:params:xml:ns:resource-lists"
  xmlns:cc="urn:ietf:params:xml:ns:copycontrol"
>
  <list>
    <entry uri="sip:anonymous@anonymous.invalid" cc:copyControl="to"
cc:count="2"/>
  </list>
</resource-lists>

```

7. SIP 200 "OK" response (from UE PoC Box B to SIP/IP Core B)

UE PoC Box B sends a SIP 200 "OK" response to SIP/IP Core B. PoC User B is not allowed to use Professional QoE Profile because he is subscribed to Premium QoE Profile.

SIP HEADERS**P-Preferred-Identity:** "PoC User B" <sip:PoC-UserB@networkB.net>**Privacy:** id**Require:** timer**Server:** PoC-uebox/OMA2.0 Acme-Talk5000/v1.01**Session-Expires:** 1800;refresher=uas**Contact:** <sip:PoC-ClientB.networkB.net>;+g.poc.talkburst;
sip.automata;sip.actor=principal;sip.description="poc recording device"**Allow:** INVITE,ACK,CANCEL,BYE,REFER,MESSAGE,OPTIONS**Accept-Language:** en**SDP PARAMETERS**

c= IN IP6 7557::eee:aaa:fff:bbb

a= poc-qoe:premium

m= audio 75575 RTP/AVP 98
 a= rtpmap:98 EVRC/8000
 a= rtcp:7500
 i= speech
 a= label:bl
 b= AS:25.4
 m= application 7559 udp TBCP
 a= ftmp:TBCP multimedia=1
 a= floorid:0 mstrm:bl

8. SIP 200 "OK" response (from SIP/IP Core B to PoC Server B)

SIP/IP Core B forwards the SIP 200 "OK" response to PoC Server B.

SIP HEADERS

P-Asserted-Identity: "PoC User B" <sip:PoC-UserB@networkB.net>
Privacy: id
Require: timer
Server: PoC-uebox/OMA2.0 Acme-Talk5000/v1.01
Session-Expires: 1800;refresher=uas
Contact: <sip:PoC-ClientB.networkB.net>;+g.poc.talkburst;
 sip.automata;sip.actor=principal;sip.description="poc recording device"
Allow: INVITE,ACK,CANCEL,BYE,REFER,MESSAGE,OPTIONS
Accept-Language: en

SDP PARAMETERS

c= IN IP6 72557::eee:aaa:fff:bbb
 a= poc-qoe:premium
 m= audio 75575 RTP/AVP 98
 a= rtpmap:98 EVRC/8000
 a= rtcp:7500
 i= speech
 a= label:bl
 b= AS:25.4

m= application 72559 udp TBCP
a= ftmp:TBCP multimedia=1
a= floorid:0 mstrm:bl

9. SIP 200 "OK" response (from PoC Server B to SIP/IP Core B)

PoC Server B sends a SIP 200 "OK" response to SIP/IP Core B.

SIP HEADERS

P-Asserted-Identity: "PoC User B" <sip:PoC-UserB@networkB.net>
Privacy: id
Require: timer
Server: PoC-serv/OMA2.0
Session-Expires: 1800;refresher=uas
Contact: <sip:PoC-SessionABCDEF@PoC-ServerB.networkB.net;b2bua>;+g.poc.talkburst; sip.automata;sip.actor=principal;sip.description="poc recording device"
Accept-Language: en

SDP PARAMETERS

c= IN IP6 99055::fff:aaa:eee:bbb
a= poc-qoe:premium
m= audio 59006 RTP/AVP 98
a= rtpmap:98 EVRC/8000
a= rtcp:50000
i= speech
b= AS:25.4
a= label:uu
a= a=upcc:0
m= application 50000 udp TBCP
a= ftmp:TBCP multimedia=1
a= floorid:0 mstrm:uu

10. SIP 200 "OK" response (from SIP/IP Core B to SIP/IP Core X)

SIP/IP Core B forwards the SIP 200 "OK" response to SIP/IP Core X.

SIP HEADERS

P-Asserted-Identity: "PoC User B" <sip:PoC-UserB@networkB.net>
Privacy: id
Require: timer
Server: PoC-serv/OMA2.0
Session-Expires: 1800;refresher=uas
Contact: <sip:PoC-SessionABCDEF@PoC-ServerB.networkB.net;b2bua>;+g.poc.talkburst; sip.automata;sip.actor=principal;sip.description="poc recording device"
Accept-Language: en

SDP PARAMETERS

c= IN IP6 99055::fff:aaa:eee:bbb
a= poc-qoe:premium
m= audio 59006 RTP/AVP 98
a= rtpmap:98 EVRC/8000
a= rtcp:50000
i= speech
b= AS:25.4
a= label:uu
a= a=upcc:0
m= application 50000 udp TBCP
a= fmp: TBCP multimedia=1
a= floorid:0 mstrm:uu

11. SIP 200 "OK" response (from SIP/IP Core X to PoC Server X)

SIP/IP Core X forwards the SIP 200 "OK" response to PoC Server X.

SIP HEADERS

P-Asserted-Identity: "PoC User B" <sip:PoC-UserB@networkB.net>
Privacy: id
Require: timer

Server: PoC-serv/OMA2.0

Session-Expires: 1800;refresher=uas

Contact: <sip:PoC-SessionABCDEF@PoC-ServerB.networkB.net;b2bua>;+g.poc.talkburst; sip.automata;sip.actor=principal;sip.description="poc recording device"

Accept-Language: en

SDP PARAMETERS

c= IN IP6 99055::fff:aaa:eee:bbb

a= poc-qoe:premium

m= audio 59006 RTP/AVP 98

a= rtpmap:98 EVRC/8000

a= rtcp:50000

i= speech

b= AS:25.4

a= label:uu

a= a=upcc:0

m= application 50000 udp TBCP

a= fmp: TBCP multimedia=1

a= floorid:0 mstrm:uu

A. MBCP Media Burst Taken message (from PoC Server X to PoC Server B).

The MBCP Media Burst Taken message is sent to inform the UE PoC Box B that PoC Client A has been granted to send a Media Burst. The message contains the identity of the PoC User that has been granted to send a Media Burst.

B. MBCP Media Burst Taken message (from PoC Server B to UE PoC Box B).

The MBCP Media Burst Taken message is sent to inform the UE PoC Box B that PoC Client A has been granted to send a Media Burst. The message contains the identity of the PoC User that has been granted to send a Media Burst.

12. SIP ACK request (from PoC Server X to SIP/IP Core X)

PoC Server X sends a SIP ACK request to SIP/IP Core X.

13. SIP ACK request (from SIP/IP Core X to SIP/IP Core B)

SIP/IP Core X forwards the SIP ACK request to SIP/IP Core B.

14. SIP ACK request (from SIP/IP Core B to PoC Server B)

SIP/IP Core B forwards the SIP ACK request to PoC Server B.

15. SIP ACK request (from PoC Server B to SIP/IP Core B)

PoC Server B sends a SIP ACK request to SIP/IP Core B.

16. SIP ACK request (from SIP/IP Core B to UE PoC Box B)

SIP/IP Core B forwards the SIP ACK request to UE PoC BoxB.

F.21.3 Terminating flow – PoC User directs UE PoC Box to accept the PoC Session

PoC Server X invites the PoC Client B to a PoC Session by sending a SIP INVITE request to the terminating SIP/IP Core.

The signaling sequences in this subclause show the establishment of the 1-1 PoC Session using on-demand signaling in the terminating side. As a prerequisite for the on-demand signaling, the PoC Client needs to be registered.

This scenario applies for the On-demand Session case.

QoE Profiles feature is used in this flow, QoE Profile assigned to the PoC Session is Professional QoE Profile and PoC Client B is subscribed and selects Premium as Local QoE Profile.

This flow shows the signaling sequence for the manual answer case when the PoC User directs the UE PoC Box to accept the PoC Session. In this example the UE PoC Box only accepts PoC Speech. The flow is as shown in **Figure 10** "*PoC Session invitation where PoC User directs UE PoC Box to accept the PoC Session*".

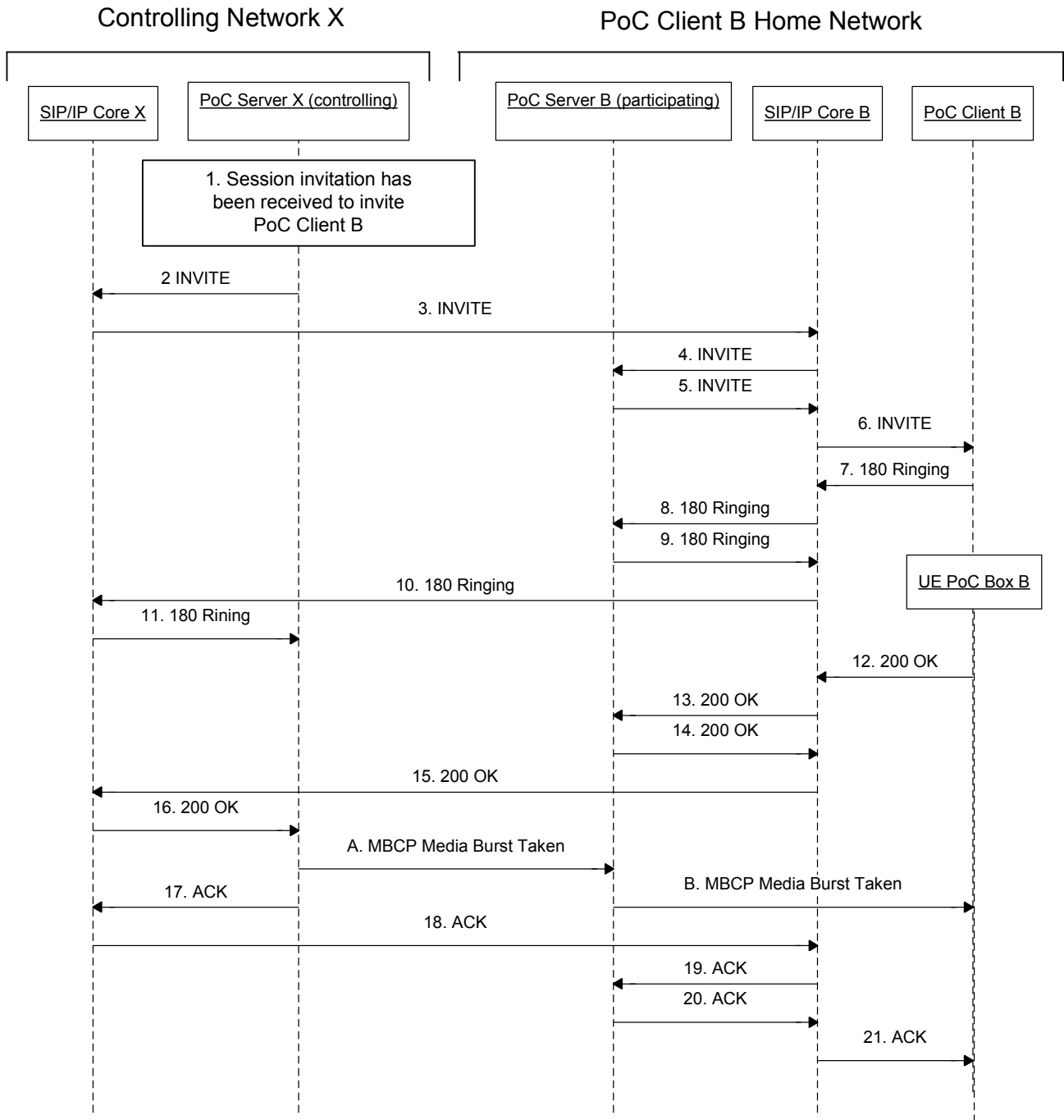

Figure 41: PoC Session invitation where PoC User directs UE PoC Box to accept the PoC Session

The steps of the flow are as follows:

1. Session invitation has been received to invite PoC Client
2. SIP INVITE request (from the PoC Server X to SIP/IP Core X)

PoC Server X sends the SIP INVITE request to SIP/IP Core X.

Request-URI sip:PoC-UserB@networkB.net

SIP HEADERS

P-Asserted-Identity: "PoC User A" <sip:PoC-UserA@networkA.net>

Accept-Contact: *,+g.poc.talkburst; require;explicit

User-Agent: PoC-serv/OMA2.0

Referred-By: "PoC User A" <sip:PoC-UserA@networkA.net>

Privacy: id

Contact: <sip:PoC-SessionABCDEF@PoC-ServerX.networkX.net;session=1-1>;+g.poc.talkburst; isfocus;+g.poc.discretemedia

Supported: 100rel,norefersub,timer

Session-Expires: 1800

Allow: INVITE,ACK,CANCEL,BYE,PRACK,UPDATE,REFER,MESSAGE,OPTIONS

Subject: Let's talk

Alert-Info: <http://publicweb.networkB.net/users/PoC-UserA@networkA.net/myFavouriteRingingTone.wav>

Call-Info: <http://publicweb.networkB.net/users/PoC-UserA@networkA.net/myOwnPicture.jpg>;purpose=icon

SDP PARAMETERS

Content-Type: application/sdp

c= IN IP6 50555::ccc:ddd:aaa:bbb

a= poc-qoe:professionnal

m= audio 53456 RTP/AVP 97 98

a= rtpmap:97 AMR

a= rtpmap:98 EVRC/8000

a= rtcp:53080

i= speech

a= label:ll

a= a=upcc:0

m= Application 50000 udp TBCP

a= fmtp:TBCP queuing=1; tb_priority=2; timestamp=1;multimedia=1;local_grant=1
a= floorid:0 mstrm:ll kk
m= video 7566 RTP/AVP 99
a= rtpmap:99 MP4V-ES
a= label:kk
a= a=upcc:0
m= message 54321 TCP/MSRP *
a= accept-types:message/cpim application/vnd.oma.poc.final-report+xml
 application/vnd.oma.poc.detailed-progress-report+xml
 application/vnd.oma.poc.optimized-progress-report+xml
a= accept-wrapped-types:text/plain
a= path:msrp://[50555::ccc:ddd:aaa:bbb]:54321/ksdGFjhafdga45sdf2a;tcp
a= max-size:100000000

Included Media Content

Content-Type: text/directory;profile="vcard";charset=UTF-8

 begin:vcard
 fn:John P. Smith
 n:Smith;John;Peter;Dr.;MBA
 EMAIL:TYPE=internet:POC-UserB@networkA.net
 version:3.0
 end:vcard

Invited parties identity information

Content-Disposition: recipient-list-history;handling="optional"
Content-Type: application/resource-lists+xml

 <?xml version="1.0" encoding="UTF-8"?>
 <resource-lists
 xmlns="urn:ietf:params:xml:ns:resource-lists"
 xmlns:cc="urn:ietf:params:xml:ns:copycontrol"

```

>
<list>
  <entry uri="sip:PoC-UserB@networkB.com" cc:copyControl="to"
cc:anonymize="true"/>
</list>
</resource-lists>

```

3. SIP INVITE request (from SIP/IP Core X to SIP/IP Core B)

SIP/IP Core X forwards the SIP INVITE request to SIP/IP Core B.

Request-URI sip:PoC-UserB@networkB.net

SIP HEADERS

P-Asserted-Identity: "PoC User A" <sip:PoC-UserA@networkA.net>

Accept-Contact: *,+g.poc.talkburst; require;explicit

User-Agent: PoC-serv/OMA2.0

Referred-By: "PoC User A" <sip:PoC-UserA@networkA.net>

Privacy: id

Contact: <sip:PoC-SessionABCDEF@PoC-ServerX.networkX.net;session=1-1>;+g.poc.talkburst;isfocus;+g.poc.discretemedia

Supported: 100rel,norefersub,timer

Session-Expires: 1800

Allow: INVITE,ACK,CANCEL,BYE,PRACK,UPDATE,REFER,MESSAGE,OPTIONS

Subject: Let's talk

Alert-Info: <http://publicweb.networkB.net/users/PoC-UserA@networkA.net/myFavouriteRingingTone.wav>

Call-Info: <http://publicweb.networkB.net/users/PoC-UserA@networkA.net/myOwnPicture.jpg>;purpose=icon

SDP PARAMETERS

Content-Type: application/sdp

c= IN IP6 50555::ccc:ddd:aaa:bbb

a= poc-qoe:professional

m= audio 53456 RTP/AVP 97 98
 a= rtpmap:97 AMR
 a= rtpmap:98 EVRC/8000
 a= rtcp:53080
 i= speech
 a= label:ll
 a= a=upcc:0
 m= Application 50000 udp TBCP
 a= fntp:TBCP queuing=1; tb_priority=2; timestamp=1;multimedia=1;local_grant=1
 a= floorid:0 mstrm:ll kk
 m= video 7566 RTP/AVP 99
 a= rtpmap:99 MP4V-ES
 a= label:kk
 a= a=upcc:0
 m= message 54321 TCP/MSRP *
 a= accept-types:message/cpim application/vnd.oma.poc.final-report+xml
 application/vnd.oma.poc.detailed-progress-report+xml
 application/vnd.oma.poc.optimized-progress-report+xml
 a= accept-wrapped-types:text/plain
 a= path:msrp://[50555::ccc:ddd:aaa:bbb]:54321/ksdghfhafdga45sdf2a;tcp
 a= max-size:100000000

Included Media Content

Content-Type: text/directory;profile="vcard";charset=UTF-8

```

begin:vcard
fn:John P. Smith
n:Smith;John;Peter;Dr.;MBA
EMAIL:TYPE=internet:POC-UserB@networkA.net
version:3.0
end:vcard
  
```

Invited parties identity

information**Content-Disposition:** recipient-list-history;handling="optional"**Content-Type:** application/resource-lists+xml

```

<?xml version="1.0" encoding="UTF-8"?>
<resource-lists
  xmlns="urn:ietf:params:xml:ns:resource-lists"
  xmlns:cc="urn:ietf:params:xml:ns:copycontrol"
>
  <list>
    <entry uri="sip:PoC-UserB@networkB.com" cc:copyControl="to"
cc:anonymize="true"/>
  </list>
</resource-lists>

```

4. SIP INVITE request (from SIP/IP Core B to PoC Server B)

SIP/IP Core B forwards the SIP INVITE request to PoC Server B.

Request-URI sip:PoC-UserB@networkB.net**SIP HEADERS****P-Asserted-Identity:** "PoC User A" <sip:PoC-UserA@networkA.net>**Accept-Contact:** *,+g.poc.talkburst; require;explicit**User-Agent:** PoC-serv/OMA2.0**Referred-By:** "PoC User A" <sip:PoC-UserA@networkA.net>**Privacy:** id**Contact:** <sip:PoC-SessionABCDEF@PoC-ServerX.networkX.net;session=1-1>;+g.poc.talkburst;isfocus;+g.poc.discretedia**Supported:** 100rel,norefersub,timer**Session-Expires:** 1800**Allow:** INVITE,ACK,CANCEL,BYE,PRACK,UPDATE,REFER,MESSAGE,OPTIONS**Subject:** Let's talk**Alert-Info:** <http://publicweb.networkB.net/users/PoC-UserA@networkA.net/myFavouriteRingtone.wav>

Call-Info: <http://publicweb.networkB.net/users/PoC-UserA@networkA.net/myOwnPicture.jpg>;purpose=icon

SDP PARAMETERS

Content-Type: application/sdp

c= IN IP6 50555::ccc:ddd:aaa:bbb
m= audio 53456 RTP/AVP 97 98
a= poc-qoe:professional
a= rtpmap:97 AMR
a= rtpmap:98 EVRC/8000
a= rtcp:53080
i= speech
a= label:ll
a= a=upcc:0
m= Application 50000 udp TBCP
a= fmp: TBCP queuing=1; tb_priority=2; timestamp=1;multimedia=1;local_grant=1
a= floorid:0 mstrm:ll kk
m= video 7566 RTP/AVP 99
a= rtpmap:99 MP4V-ES
a= label:kk
a= a=upcc:0
m= message 54321 TCP/MSRP *
a= accept-types:message/cpim application/vnd.oma.poc.final-report+xml
application/vnd.oma.poc.detailed-progress-report+xml
application/vnd.oma.poc.optimized-progress-report+xml
a= accept-wrapped-types:text/plain
a= path:msrp://[50555::ccc:ddd:aaa:bbb]:54321/ksdghafhdga45sdf2a;tcp
a= max-size:100000000

Included Media Content

Content-Type: text/directory;profile="vcard";charset=UTF-8

```

begin:vcard
fn:John P. Smith
n:Smith;John;Peter;Dr.;MBA
EMAIL:TYPE=internet:POC-UserB@networkA.net
version:3.0
end:vcard

```

Invited parties identity information

Content-Disposition: recipient-list-history;handling="optional"
Content-Type: application/resource-lists+xml

```

<?xml version="1.0" encoding="UTF-8"?>
<resource-lists
  xmlns="urn:ietf:params:xml:ns:resource-lists"
  xmlns:cc="urn:ietf:params:xml:ns:copycontrol"
>
  <list>
    <entry uri="sip:PoC-UserB@networkB.com" cc:copyControl="to"
cc:anonymize="true"/>
  </list>
</resource-lists>

```

5. SIP INVITE request (from PoC Server B to SIP/IP Core B)

PoC Server B sends a SIP INVITE request to SIP/IP Core B.

Request-URI sip:PoC-UserB@networkB.net

SIP HEADERS

P-Asserted-Identity: "PoC User A" <sip:PoC-UserA@networkA.net>

Accept-Contact: *,+g.poc.talkburst; require;explicit

User-Agent: PoC-serv/OMA2.0

Privacy: id

Contact: <sip:PoC-SessionABCDEF@PoC_ServerB.networkB.net;session=1-

1>;+g.poc.talkburst;isfocus;+g.poc.discretemedia

Supported: norefersub,timer

Session-Expires: 1800

Answer-Mode: Manual;Require

Allow: INVITE,ACK,CANCEL,BYE,PRACK,UPDATE,REFER,MESSAGE,OPTIONS

Subject: Let's talk

Alert-Info: <http://publicweb.networkB.net/users/PoC-UserA@networkA.net/myFavouriteRingingTone.wav>

Call-Info: <http://publicweb.networkB.net/users/PoC-UserA@networkA.net/myOwnPicture.jpg>;purpose=icon

SDP PARAMETERS

c= IN IP6 60333::ddd: ccc:aaa:bbb

a= poc-qoe:professional

m= audio 63776 RTP/AVP 98

a= rtpmap:98 EVRC/8000

a= rtcp:63090

i= speech

a= label:al

m= Application 60000 udp TBCP

a= fmtp:TBCP queuing=1; tb_priority=2; timestamp=1;multimedia=1;local_grant=1

a= floorid:0 mstrm:al ak

m= video 47566 RTP/AVP 99

a= rtpmap:99 MP4V-ES

a= label:ak

a= a=upcc:0

m= message 44321 TCP/MSRP *

a= accept-types:message/cpim application/vnd.oma.poc.final-report+xml
application/vnd.oma.poc.detailed-progress-report+xml
application/vnd.oma.poc.optimized-progress-report+xml

a= accept-wrapped-types:text/plain

a= path:msrp://[60333::ddd: ccc:aaa:bbb]:44321/gsgsdfg4;tcp

a= max-size:10000000

Included Media Content

Content-Type: text/directory;profile="vcard";charset=UTF-8

```

begin:vcard
fn:John P. Smith
n:Smith;John;Peter;Dr.;MBA
EMAIL:TYPE=internet:POC-UserB@networkA.net
version:3.0
end:vcard

```

Invited parties identity information

Content-Disposition: recipient-list-history;handling="optional"

Content-Type: application/resource-lists+xml

```

<?xml version="1.0" encoding="UTF-8"?>
<resource-lists
  xmlns="urn:ietf:params:xml:ns:resource-lists"
  xmlns:cc="urn:ietf:params:xml:ns:copycontrol"
>
  <list>
    <entry uri="sip:anonymous@anonymous.invalid" cc:copyControl="to"
cc:count="2"/>
  </list>
</resource-lists>

```

6. SIP INVITE request (from SIP/IP Core B to PoC Client B)

SIP/IP Core B forwards the SIP INVITE request to PoC Client B.

Request-URI sip:PoC-UserB@networkB.net

SIP HEADERS

Accept-Contact: *,+g.poc.talkburst; require;explicit

User-Agent: PoC-serv/OMA2.0
Contact: <sip:PoC-SessionABCDEF@PoC_ServerB.networkB.net;session=1-1>;
 +g.poc.talkburst;isfocus;+g.poc.discretemedia
Supported: norefersub,timer
Session-Expires: 1800
Answer-Mode: Manual;Require
Allow: INVITE,ACK,CANCEL,BYE,PRACK,UPDATE,REFER,MESSAGE,OPTIONS
Subject: Let's talk
Alert-Info: <http://publicweb.networkB.net/users/PoC-
 UserA@networkA.net/myFavouriteRingingTone.wav>
Call-Info: <http://publicweb.networkB.net/users/PoC-
 UserA@networkA.net/myOwnPicture.jpg>;purpose=icon

SDP PARAMETERS

c= IN IP6 60333::ddd:ccc:aaa:bbb
a= poc-qoe:professional
m= audio 63776 RTP/AVP 98
a= rtpmap:98 EVRC/8000
a= rtcp:63090
i= speech
a= label:al
m= Application 60000 udp TBCP
a= fmtp:TBCP queuing=1; tb_priority=2; timestamp=1;multimedia=1;local_grant=1
a= floorid:0 mstrm:al ak
m= video 47566 RTP/AVP 99
a= rtpmap:99 MP4V-ES
a= label:ak
a= a=upcc:0
m= message 44321 TCP/MSRP *
a= accept-types:message/cpim application/vnd.oma.poc.final-report+xml
 application/vnd.oma.poc.detailed-progress-report+xml
 application/vnd.oma.poc.optimized-progress-report+xml
a= accept-wrapped-types:text/plain
a= path:msrp://[60333::ddd:ccc:aaa:bbb]:44321/gsgsdfg4;tcp

a= max-size:100000000

Included Media Content

Content-Type: text/directory;profile="vcard";charset=UTF-8

```
begin:vcard
fn:John P. Smith
n:Smith;John;Peter;Dr.;MBA
EMAIL:TYPE=internet:POC-UserB@networkA.net
version:3.0
end:vcard
```

Invited parties identity information

Content-Disposition: recipient-list-history;handling="optional"

Content-Type: application/resource-lists+xml

```
<?xml version="1.0" encoding="UTF-8"?>
<resource-lists
  xmlns="urn:ietf:params:xml:ns:resource-lists"
  xmlns:cc="urn:ietf:params:xml:ns:copycontrol"
>
  <list>
    <entry uri="sip:anonymous@anonymous.invalid" cc:copyControl="to"
cc:count="2"/>
  </list>
</resource-lists>
```

7. SIP 180 "Ringing" response (from PoC Client B to SIP/IP Core B)

PoC Client B sends a SIP 180 "Ringing" response to SIP/IP Core B.

SIP HEADERS

P-Preferred-Identity: "PoC User B" <sip:PoC-UserB@networkB.net>

Privacy: id
Require: timer
Server: PoC-client/OMA2.0 Acme-Talk5000/v1.01
Contact: <sip:PoC-ClientB.networkB.net>;+g.poc.talkburst;+g.poc.fdcfo
Allow: INVITE,ACK,CANCEL,BYE,REFER,MESSAGE,OPTIONS
Accept-Language: en

8. SIP 180 "Ringing" response (from SIP/IP Core B to PoC Server B)

SIP/IP Core B forwards the SIP 180 "Ringing" response to PoC Server B.

SIP HEADERS

P-Asserted-Identity: "PoC User B" <sip:PoC-UserB@networkB.net>
Privacy: id
Require: timer
Server: PoC-client/OMA2.0 Acme-Talk5000/v1.01
Contact: <sip:PoC-ClientB.@networkB.net>; +g.poc.talkburst;+g.poc.fdcfo
Allow: INVITE,ACK,CANCEL,BYE,REFER,MESSAGE,OPTIONS
Accept-Language: en

9. SIP 180 "Ringing" response (from PoC Server B to SIP/IP Core B)

PoC Server B sends a SIP 180 "Ringing" response to SIP/IP Core B.

SIP HEADERS

P-Asserted-Identity: "PoC User B" <sip:PoC-UserB@networkB.net>
Privacy: id
Server: PoC-serv/OMA2.0
Contact: <sip:PoC-SessionABCDEF@PoC-ServerB.networkB.net;b2bua>;+g.poc.talkburst;+g.poc.fdcfo
Allow: INVITE,ACK,CANCEL,BYE,REFER,PRACK,UPDATE,MESSAGE,OPTIONS

10. SIP 180 "Ringing" response (from SIP/IP Core B to SIP/IP Core X)

SIP/IP Core B forwards the SIP 180 "Ringing" response to SIP/IP Core X.

SIP HEADERS

P-Asserted-Identity: "PoC User B" <sip:PoC-UserB@networkB.net>
Privacy: id
Server: PoC-serv/OMA2.0
Contact: <sip:PoC-SessionABCDEF@PoC-ServerB.networkB.net>;+g.poc.talkburst;+g.poc.fdcfo
Allow: INVITE,ACK,CANCEL,BYE,REFER,PRACK,UPDATE,MESSAGE,OPTIONS

11. SIP 180 "Ringing" response (from SIP/IP Core X to PoC Server X)

SIP/IP Core X forwards the SIP 180 "Ringing" response to PoC Server X.

SIP HEADERS

P-Asserted-Identity: "PoC User B" <sip:PoC-UserB@networkB.net>
Privacy: id
Server: PoC-serv/OMA2.0
Contact: <sip:PoC-SessionABCDEF@PoC-ServerB.networkB.net>;+g.poc.talkburst;+g.poc.fdcfo
Allow: INVITE,ACK,CANCEL,BYE,REFER,PRACK,UPDATE,MESSAGE,OPTIONS

12. SIP 200 "OK" response (from UE PoC Box B to SIP/IP Core B)

The PoC User B directs the UE PoC Box to accept the PoC Session. The UE PoC Box B sends a SIP 200 "OK" response to SIP/IP Core B. In this example the UE PoC Box only accepts PoC Speech. PoC User B is not allowed to use Professional QoE Profile because he is subscribed to Premium QoE Profile.

SIP HEADERS

P-Preferred-Identity: "PoC User B" <sip:PoC-UserB@networkB.net>
Privacy: id
Require: timer
Server: PoC-uebox/OMA2.0 Acme-Talk5000/v1.01
Session-Expires: 1800;refresher=uas
Contact: <sip:PoC-ClientB.networkB.net>;+g.poc.talkburst;
sip.automata;sip.actor=principal;sip.description="poc recording device"
Allow: INVITE,ACK,CANCEL,BYE,REFER,MESSAGE,OPTIONS
Accept-Language: en

SDP PARAMETERS

c= IN IP6 75555::eee:aaa:fff:bbb
 a= poc-qoe:premium
 m= audio 7557 RTP/AVP 98
 a= rtpmap:98 EVRC/8000
 a= rtcp:7500
 i= speech
 a= label:bl
 b= AS:25.4
 m= application 7559 udp TBCP
 a= fmp: TBCP multimedia=1
 a= floorid:0 mstrm:bl
 m= video 0 RTP/AVP 99
 m= message 0 TCP/MSRP *

13. SIP 200 "OK" response (from SIP/IP Core B to PoC Server B)

SIP/IP Core B forwards the SIP 200 "OK" response to PoC Server B.

SIP HEADERS

P-Asserted-Identity: "PoC User B" <sip:PoC-UserB@networkB.net>
Privacy: id
Require: timer
Server: PoC-uebox/OMA2.0 Acme-Talk5000/v1.01
Session-Expires: 1800;refresher=uas
Contact: <sip:PoC-ClientB.networkB.net>;+g.poc.talkburst;
 sip.automata;sip.actor=principal;sip.description="poc recording device"
Allow: INVITE,ACK,CANCEL,BYE,REFER,MESSAGE,OPTIONS
Accept-Language: en

SDP PARAMETERS

c= IN IP6 75555::eee:aaa:fff:bbb
 a= poc-qoe:premium
 m= audio 7557 RTP/AVP 98

```

a=          rtpmap:98 EVRC/8000
a=          rtcp:7559
i=          speech
a=          label:bl
b=          AS:25.4
m=          application 75590 udp TBCP
a=          fmp: TBCP multimedia=1
a=          floorid:0 mstrm:bl
m=          video 0 RTP/AVP 99
m=          message 0 TCP/MSRP *

```

14. SIP 200 "OK" response (from PoC Server B to SIP/IP Core B)

PoC Server B sends a SIP 200 "OK" response to SIP/IP Core B.

SIP HEADERS

```

P-Asserted-Identity:    "PoC User B" <sip:PoC-UserB@networkB.net>
Privacy:                id
Require:                timer
Server:                 PoC-serv/OMA2.0
Session-Expires:       1800;refresher=uas
Contact:                <sip:PoC-SessionABCDEF@PoC-
                             ServerB.networkB.net;b2bua>;+g.poc.talkburst;
                             sip.automata;sip.actor=principal;sip.description="poc recording device"
Accept-Language:       en

```

SDP PARAMETERS

```

c=          IN IP6 99055::fff:aaa:eee:bbb
a=          poc-qoe:premium
m=          audio 59006 RTP/AVP 98
a=          rtpmap:98 EVRC/8000
a=          rtcp:50000
i=          speech
b=          AS:25.4

```

a= label:uu
 a= a=upcc:0
 m= application 50000 udp TBCP
 a= fmtp:TBCP multimedia=1
 a= floorid:0 mstrm:uu
 m= video 0 RTP/AVP 99
 m= message 0 TCP/MSRP *

15. SIP 200 "OK" response (from SIP/IP Core B to SIP/IP Core X)

SIP/IP Core B forwards the SIP 200 "OK" response to SIP/IP Core X.

SIP HEADERS

P-Asserted-Identity: "PoC User B" <sip:PoC-UserB@networkB.net>
Privacy: id
Require: timer
Server: PoC-serv/OMA2.0
Session-Expires: 1800;refresher=uas
Contact: <sip:PoC-SessionABCDEF@PoC-ServerB.networkB.net;b2bua>;+g.poc.talkburst; sip.automata;sip.actor=principal;sip.description="poc recording device"
Accept-Language: en

SDP PARAMETERS

c= IN IP6 99055::fff:aaa:eee:bbb
 a= poc-qoe:premium
 m= audio 59006 RTP/AVP 98
 a= rtpmap:98 EVRC/8000
 a= rtcp:50000
 i= speech
 b= AS:25.4
 a= label:uu
 a= a=upcc:0
 m= application 50000 udp TBCP

a= fmtp:TBCP multimedia=1
a= floorid:0 mstrm:uu
m= video 0 RTP/AVP 99
m= message 0 TCP/MSRP *

16. SIP 200 "OK" response (from SIP/IP Core X to PoC Server X)

SIP/IP Core X forwards the SIP 200 "OK" response to PoC Server X.

SIP HEADERS

P-Asserted-Identity: "PoC User B" <sip:PoC-UserB@networkB.net>
Privacy: id
Require: timer
Server: PoC-serv/OMA2.0
Session-Expires: 1800;refresher=uas
Contact: <sip:PoC-SessionABCDEF@PoC-
ServerB.networkB.net;b2bua>;+g.poc.talkburst;
sip.automata;sip.actor=principal;sip.description="poc recording device"
Accept-Language: en

SDP PARAMETERS

c= IN IP6 99055::fff:aaa:eee:bbb
a= poc-qoe:premium
m= audio 59006 RTP/AVP 98
a= rtpmap:98 EVRC/8000
a= rtcp:50000
i= speech
b= AS:25.4
a= label:uu
a= a=upcc:0
m= application 50000 udp TBCP
a= fmtp:TBCP multimedia=1
a= floorid:0 mstrm:uu
m= video 0 RTP/AVP 99

m= message 0 TCP/MSRP *

A. MBCP Media Burst Taken message (from PoC Server X to PoC Server B).

The MBCP Media Burst Taken message is sent to inform the UE PoC Box B that PoC Client A has been granted to send a Media Burst. The message contains the identity of the PoC User that has been granted to send a Media Burst.

B. MBCP Media Burst Taken message (from PoC Server B to UE PoC Box B).

The MBCP Media Burst Taken message is sent to inform the UE PoC Box B that PoC Client A has been granted to send a Media Burst. The message contains the identity of the PoC User that has been granted to send a Media Burst.

17. SIP ACK request (from PoC Server X to SIP/IP Core X)

PoC Server X sends a SIP ACK request to SIP/IP Core X.

19. SIP ACK request (from SIP/IP Core X to SIP/IP Core B)

SIP/IP Core X forwards the SIP ACK request to SIP/IP Core B.

19. SIP ACK request (from SIP/IP Core B to PoC Server B)

SIP/IP Core B forwards the SIP ACK request to PoC Server B.

20. SIP ACK request (from PoC Server B to SIP/IP Core B)

PoC Server B sends a SIP ACK request to SIP/IP Core B.

21. SIP ACK request (from SIP/IP Core B to UE PoC Box B)

SIP/IP Core B forwards the SIP ACK request to UE PoC BoxB.

Appendix G. Change History

(Informative)

G.1 Approved Version History

Reference	Date	Description
n/a	n/a	No prior version

G.2 Draft/Candidate Version 2.0 History

Document Identifier	Date	Sections	Description
Draft Versions OMA-TS-PoC_ControlPlane-V2_0	10 Nov 2005	All	The initial version of this document.
	19 May 2006	All	New base line created using the OMA-TS-Poc-ControlPlane-V1_0_20060519-C OMA-ERP-PoC-V1_0-20060519-C as base. The following CRs is included: OMA-POC-POCv2-2006-0471r02e
	22 May 2006	All	New base line created using the OMA-TS-Poc-ControlPlane-V1_0_20060519-D as base. Creating an Appendix X with preliminary text as agreed during the Kansas City meeting.
	26 Jun 2006	All	Updated according to agreed CRs: OMA-POC-POCv2-2006-0515, OMA-POC-POCv2-2006-0524R01, OMA-POC-POCv2-2006-0532, OMA-POC-POCv2-2006-0563R01 & OMA-POC-POCv2-2006-0545R02
	30 Jun 2006	Cover page	Changed Candidate to Draft
	24 Jul 2006	All	Updated according to agreed CRs: OMA-POC-POCv2-2006-0508R02, OMA-POC-POCv2-2006-0509R02, OMA-POC-POCv2-2006-0582R01, OMA-POC-POCv2-2006-0592R01, OMA-POC-POCv2-2006-0593R01, OMA-POC-POCv2-2006-0594R01, OMA-POC-POCv2-2006-0604R02, OMA-POC-POCv2-2006-0606R01, OMA-POC-POCv2-2006-0607R01, OMA-POC-POCv2-2006-0608R01, OMA-POC-POCv2-2006-0634R01, OMA-POC-POCv2-2006-0637R01, OMA-POC-POCv2-2006-0638R01 & some reformatting
	29 Jul 2006	7.2.1.1.a, 6.1.13, 7.1.2	Updated according to agreed CRs: OMA-POC-POCv2-2006-0507R04, OMA-POC-POCv2-2006-0603R01, Contributors note removed
	07 Aug 2006	7.2.1.11	Updated according to agreed CRS: OMA-POC-POCv2-2006-0551R02 & OMA-POC-POCv2-2006-0549R03

	30 Aug 2006	All	Updated according to agreed CRs: OMA-POC-POCv2-2006-0661; OMA-POC-POCv2-2006-0684, OMA-POC-POCv2-2006-0686, OMA-POC-POCv2-2006-0695, OMA-POC-POCv2-2006-0668, OMA-POC-POCv2-2006-0662, OMA-POC-POCv2-2006-0683, OMA-POC-POCv2-2006-0688, OMA-POC-POCv2-2006-0741R02, OMA-POC-POCv2-2006-0660, OMA-POC-POCv2-2006-0682, OMA-POC-POCv2-2006-0690, OMA-POC-POCv2-2006-0691 OMA-POC-POCv2-2006-R02, OMA-POC-POCv2-2006-0737R01, OMA-POC-POCv2-2006-0752R01,
	11 Sep 2006	All	Updated according to agreed CRs: OMA-POC-POCv2-2006-0628R02, OMA-POC-POCv2-2006-0655, OMA-POC-POCv2-2006-0658R01, OMA-POC-POCv2-2006-0663 & OMA-POC-POCv2-2006-705R02
	03 Oct 2006	All	Updated according to agreed CRs: OMA-POC-POCv2-2006-0659R02, OMA-POC-POCv2-2006-0706R03, OMA-POC-POCv2-2006-0722R01, OMA-POC-POCv2-2006-0723R01, OMA-POC-POCv2-2006-0724R01, OMA-POC-POCv2-2006-0725R02, OMA-POC-POCv2-2006-0726R02, OMA-POC-POCv2-2006-0727R02, OMA-POC-POCv2-2006-0729R02, OMA-POC-POCv2-2006-0731R02, OMA-POC-POCv2-2006-0734R02, OMA-POC-POCv2-2006-0736R01, OMA-POC-POCv2-2006-0775R01, OMA-POC-POCv2-2006-0776R01, OMA-POC-POCv2-2006-0779R01, OMA-POC-POCv2-2006-0780R01, OMA-POC-POCv2-2006-0781R01, OMA-POC-POCv2-2006-0782R01, OMA-POC-POCv2-2006-0783R01, OMA-POC-POCv2-2006-0784, OMA-POC-POCv2-2006-0785R01, OMA-POC-POCv2-2006- 0786R02, OMA-POC-POCv2-2006-0787, OMA-POC-POCv2-2006-0788R01, OMA-POC-POCv2-2006-0789R01, OMA-POC-POCv2-2006-0797, OMA-POC-POCv2-2006-0798, OMA-POC-POCv2-2006-0803R02, OMA-POC-POCv2-2006-0804, OMA-POC-POCv2-2006-0808R01, OMA-POC-POCv2-2006-0810R02, OMA-POC-POCv2-2006-0811R02, OMA-POC-POCv2-2006-0812, OMA-POC-POCv2-2006-0818R02,

			<p>OMA-POC-POCv2-2006-0820R01, OMA-POC-POCv2-2006-0821R01, OMA-POC-POCv2-2006-0822, OMA-POC-POCv2-2006-0823R01, OMA-POC-POCv2-2006-0824R01, OMA-POC-POCv2-2006-0825, OMA-POC-POCv2-2006- 0832R01, OMA-POC-POCv2-2006-0840R02, OMA-POC-POCv2-2006-0845R01, OMA-POC-POCv2-2006-0846, OMA-POC-POCv2-2006-0847R01, OMA-POC-POCv2-2006-0854, OMA-POC-POCv2-2006-0858R01, OMA-POC-POCv2-2006-0859R01, OMA-POC-POCv2-2006-0860, OMA-POC-POCv2-2006-0861R01, OMA-POC-POCv2-2006-0862R01, OMA-POC-POCv2-2006-0863, OMA-POC-POCv2-2006-0864R01, OMA-POC-POCv2-2006-0865, OMA-POC-POCv2-2006-0866R01, OMA-POC-POCv2-2006-0869R02, OMA-POC-POCv2-2006-0870R03, OMA-POC-POCv2-2006-0872, OMA-POC-POCv2-2006-0873, OMA-POC-POCv2-2006-0874R01, OMA-POC-POCv2-2006-0876R01, OMA-POC-POCv2-2006-0877R01, OMA-POC-POCv2-2006-0878R01, OMA-POC-POCv2-2006-0884, OMA-POC-POCv2-2006-0886R01 & OMA-POC-POCv2-2006-0888</p>
	04 Oct 2006	All	<p>Updated according to agreed CRs: OMA-POC-POCv2-2006-0496R01, OMA-POC-POCv2-2006-0764R01, OMA-POC-POCv2-2006-0805R01 & OMA-POC-POCv2-2006-0896R01. Corrections to implementation of OMA-POC-POCv2-2006-0659R02.</p>
	05 Oct 2006	All	<p>Updated according to agreed CRs: OMA-POC-POCv2-2006-0627R03, OMA-POC-POCv2-2006-0768R02 and corrections to implementation of OMA-POC-POCv2-2006- 0805R01</p>
	30 Oct 2006	All	<p>Updated according to agreed CRs: OMA-POC-POCv2-2006-0644R02; OMA-POC-POCv2-2006-0645R01; OMA-POC-POCv2-2006-0693R04; OMA-POC-POCv2-2006-0753R02; OMA-POC-POCv2-2006-0826R03, OMA-POC-POCv2-2006-0839; OMA-POC-POCv2-2006-0879R03; OMA-POC-POCv2-2006-0881R02; OMA-POC-POCv2-2006-0910; OMA-POC-POCv2-2006-0913R01; OMA-POC-POCv2-2006-0930R01; OMA-POC-POCv2-2006-0932R02; OMA-POC-POCv2-2006-0933; OMA-POC-POCv2-2006-0934;</p>

		<p>OMA-POC-POCv2-2006-0937R01; OMA-POC-POCv2-2006-0938; OMA-POC-POCv2-2006-0939; OMA-POC-POCv2-2006-0943R01; OMA-POC-POCv2-2006-0944R02; OMA-POC-POCv2-2006-0945R01; OMA-POC-POCv2-2006-0946R01; OMA-POC-POCv2-2006-0949R01; OMA-POC-POCv2-2006-0951R01; OMA-POC-POCv2-2006-0952; OMA-POC-POCv2-2006-0953; OMA-POC-POCv2-2006-0955R01; OMA-POC-POCv2-2006-0956R02; OMA-POC-POCv2-2006-0957R01; OMA-POC-POCv2-2006-0958; OMA-POC-POCv2-2006-0964; OMA-POC-POCv2-2006-0967; OMA-POC-POCv2-2006-0969R01; OMA-POC-POCv2-2006-0970R01; OMA-POC-POCv2-2006-0971R01; OMA-POC-POCv2-2006-0972R01; OMA-POC-POCv2-2006-0973R01; OMA-POC-POCv2-2006-0974R01; OMA-POC-POCv2-2006-0975; OMA-POC-POCv2-2006-0976R01; OMA-POC-POCv2-2006-0977; OMA-POC-POCv2-2006-0978; OMA-POC-POCv2-2006-0979R01; OMA-POC-POCv2-2006-0980R01; OMA-POC-POCv2-2006-0981R01; OMA-POC-POCv2-2006-0982R01; OMA-POC-POCv2-2006-0983R01; OMA-POC-POCv2-2006-0984R03; OMA-POC-POCv2-2006-0987R02; OMA-POC-POCv2-2006-0995R01; OMA-POC-POCv2-2006-0997; OMA-POC-POCv2-2006-1005R01; OMA-POC-POCv2-2006-1006; OMA-POC-POCv2-2006-1008R01; OMA-POC-POCv2-2006-1015R01; OMA-POC-POCv2-2006-1016R01; OMA-POC-POCv2-2006-1018R01; OMA-POC-POCv2-2006-1019R02; OMA-POC-POCv2-2006-1020; OMA-POC-POCv2-2006-1021R01; OMA-POC-POCv2-2006-1028R01; OMA-POC-POCv2-2006-1030R01; OMA-POC-POCv2-2006-1037; OMA-POC-POCv2-2006-1037R03; OMA-POC-POCv2-2006-1040R02; OMA-POC-POCv2-2006-1044R01; OMA-POC-POCv2-2006-1065R01; OMA-POC-POCv2-2006-1033R01; OMA-POC-POCv2-2006-1070R02; OMA-POC-POCv2-2006-1074;</p>
--	--	---

	02 Nov 2006	All	Updated according to agreed CR: OMA-POC-POCv2-2006-0966R02, Minor editorials & clean up of headers.
	27 Nov 2006	All	Updated according to agreed CRs: OMA-POC-POCv2-2006-1116R01, OMA-POC-POCv2-2006-0914R03; OMA-POC-POCv2-2006-0940R02; OMA-POC-POCv2-2006-1007R01; OMA-POC-POCv2-2006-1014R01; OMA-POC-POCv2-2006-1061R02; OMA-POC-POCv2-2006-1083R05; OMA-POC-POCv2-2006-1089; OMA-POC-POCv2-2006-1092; OMA-POC-POCv2-2006-1108R01; OMA-POC-POCv2-2006-1113R01; OMA-POC-POCv2-2006-116R01; OMA-POC-POCv2-2006-1121; OMA-POC-POCv2-2006-1130R01; OMA-POC-POCv2-2006-1130; OMA-POC-POCv2-2006-1136; OMA-POC-POCv2-2006-1145R01; OMA-POC-POCv2-2006-1146R01; OMA-POC-POCv2-2006-1153R01; OMA-POC-POCv2-2006-1156R01; OMA-POC-POCv2-2006-1158R01; OMA-POC-POCv2-2006-1163; OMA-POC-POCv2-2006-1165R01; OMA-POC-POCv2-2006-1177; OMA-POC-POCv2-2006-1179R02; OMA-POC-POCv2-2006-1182R01; OMA-POC-POCv2-2006-1203R01; OMA-POC-POCv2-2006-1204R01; OMA-POC-POCv2-2006-1208; OMA-POC-POCv2-2006-1210R01; OMA-POC-POCv2-2006-1211R01; OMA-POC-POCv2-2006-1212; OMA-POC-POCv2-2006-1213R01; OMA-POC-POCv2-2006-1214R01; OMA-POC-POCv2-2006-1215R01; OMA-POC-POCv2-2006-1216; OMA-POC-POCv2-2006-1217R01; OMA-POC-POCv2-2006-1218; OMA-POC-POCv2-2006-1222; OMA-POC-POCv2-2006-1224; OMA-POC-POCv2-2006-1225; OMA-POC-POCv2-2006-1226R01; OMA-POC-POCv2-2006-1230; OMA-POC-POCv2-2006-1231R01; OMA-POC-POCv2-2006-1233; OMA-POC-POCv2-2006-1234R01; OMA-POC-POCv2-2006-1237R01
	30 Nov 2006	All	Updated according to agreed CRs which were missed in last version: OMA-POC-POCv2-2006-0947R01, OMA-POC-POCv2-2006-1129 Corrections to implementation of CRs: OMA-POC-POCv2-2006-1204R01 & OMA-POC-POCv2-2006-1007R01

	03 Dec 2006	All	Updated according to agreed CRs: OMA-POC-POCv2-2006-0941R02; OMA-POC-POCv2-2006-0942R02; OMA-POC-POCv2-2006-1082R01; OMA-POC-POCv2-2006-1122R02; OMA-POC-POCv2-2006-1144R03; OMA-POC-POCv2-2006-1190R01; OMA-POC-POCv2-2006-1197R01; OMA-POC-POCv2-2006-1223R01
	21 Dec 2006	All	Updated according to agreed CRs: OMA-POC-POCv2-2006-1036R02 OMA-POC-POCv2-2006-1079 OMA-POC-POCv2-2006-1134R02 OMA-POC-POCv2-2006-1152R02 OMA-POC-POCv2-2006-1172R03 OMA-POC-POCv2-2006-1188R06 OMA-POC-POCv2-2006-1193R02 OMA-POC-POCv2-2006-1209R03 OMA-POC-POCv2-2006-1227R03 OMA-POC-POCv2-2006-1228R01 OMA-POC-POCv2-2006-1236 OMA-POC-POCv2-2006-1245 OMA-POC-POCv2-2006-1246 OMA-POC-POCv2-2006-1247R01 OMA-POC-POCv2-2006-1248R01 OMA-POC-POCv2-2006-1260R01 OMA-POC-POCv2-2006-1274 OMA-POC-POCv2-2006-1303R03 OMA-POC-POCv2-2006-1306 OMA-POC-POCv2-2006-1307 OMA-POC-POCv2-2006-1309 OMA-POC-POCv2-2006-1311R01 OMA-POC-POCv2-2006-1312R03 OMA-POC-POCv2-2006-1313 OMA-POC-POCv2-2006-1317 OMA-POC-POCv2-2006-1320R02 OMA-POC-POCv2-2006-1321 OMA-POC-POCv2-2006-1322 OMA-POC-POCv2-2006-1324 OMA-POC-POCv2-2006-1325 OMA-POC-POCv2-2006-1326R02 OMA-POC-POCv2-2006-1327 OMA-POC-POCv2-2006-1328 OMA-POC-POCv2-2006-1330R01 OMA-POC-POCv2-2006-1331 OMA-POC-POCv2-2006-1332R02 OMA-POC-POCv2-2006-1338 OMA-POC-POCv2-2006-1339 OMA-POC-POCv2-2006-1340 OMA-POC-POCv2-2006-1341R01 OMA-POC-POCv2-2006-1349 OMA-POC-POCv2-2006-1350 OMA-POC-POCv2-2006-1351 OMA-POC-POCv2-2006-1354R01 OMA-POC-POCv2-2006-1360 OMA-POC-POCv2-2006-1361R01 OMA-POC-POCv2-2006-1362R01 OMA-POC-POCv2-2006-1364R02 OMA-POC-POCv2-2006-1365

			<p>OMA-POC-POCv2-2006-1366R01 OMA-POC-POCv2-2006-1367R01 OMA-POC-POCv2-2006-1369 OMA-POC-POCv2-2006-1371R01 OMA-POC-POCv2-2006-1372R01 OMA-POC-POCv2-2006-1373 OMA-POC-POCv2-2006-1374R01 OMA-POC-POCv2-2006-1375 OMA-POC-POCv2-2006-1376R01 OMA-POC-POCv2-2006-1377R01 OMA-POC-POCv2-2006-1378 OMA-POC-POCv2-2006-1379 OMA-POC-POCv2-2006-1380 OMA-POC-POCv2-2006-1381 OMA-POC-POCv2-2006-1383 OMA-POC-POCv2-2006-1385R02 OMA-POC-POCv2-2006-1386 OMA-POC-POCv2-2006-1387 OMA-POC-POCv2-2006-1389R01 OMA-POC-POCv2-2006-1390 OMA-POC-POCv2-2006-1392R01 OMA-POC-POCv2-2006-1393 OMA-POC-POCv2-2006-1394R01 OMA-POC-POCv2-2006-1397R01 OMA-POC-POCv2-2006-1398 OMA-POC-POCv2-2006-1399 OMA-POC-POCv2-2006-1400R03 OMA-POC-POCv2-2006-1403R01 OMA-POC-POCv2-2006-1407R01 OMA-POC-POCv2-2006-1409 OMA-POC-POCv2-2006-1410R02 OMA-POC-POCv2-2006-1414R01 OMA-POC-POCv2-2006-1432 OMA-POC-POCv2-2006-1439R01 OMA-POC-POCv2-2006-1440 OMA-POC-POCv2-2006-1442 OMA-POC-POCv2-2006-1443R01 OMA-POC-POCv2-2006-1445 OMA-POC-POCv2-2006-1446 OMA-POC-POCv2-2006-1465R02 OMA-POC-POCv2-2006-1468R02 OMA-POC-POCv2-2006-1469R01 OMA-POC-POCv2-2006-1475R01 OMA-POC-POCv2-2006-1486R02 OMA-POC-POCv2-2006-1500</p>
	19 Feb 2007	All	<p>Consistency review comments solved: D3, D10, D11, D15, D17, D18, D23, D31, D35, D40, D48, D51, D52, D53, D54, D55, D57, D60, D67, D79, D88, D90, D94, D98, D106, D110, D112, D114, D124; D129; D130; D141; D141; D147; D171, D172, D173, D178, D181, D182, D193, D194, D211, D227, D231, D238, D246, D265, D291, D314, D333, D334, D338, D344, D358, D364, D381, D382, D388, D395, D409, D410, D418, D444, D445, D468, D477, D522, D540, D543, D550, D551, D552, D572, D576, D588, D590, D591, D598, D610, D615, D617, D622, D644, D675, D720, D735, D803, D865 And Updated according to agreed CRs: OMA-POC-POCv2-2006-1262 OMA-POC-POCv2-2006-1471R01 OMA-POC-POCv2-2006-1489</p>

			<p>OMA-POC-POCv2-2006-1479 OMA-POC-POCv2-2007-0004 OMA-POC-POCv2-2007-0014R01 OMA-POC-POCv2-2007-0016 OMA-POC-POCv2-2007-0022R01 OMA-POC-POCv2-2007-0048R01 OMA-POC-POCv2-2007-0073R01 OMA-POC-POCv2-2007-0083R01 OMA-POC-POCv2-2007-0086R01 OMA-POC-POCv2-2007-0087 OMA-POC-POCv2-2007-0088 OMA-POC-POCv2-2007-0089R01 OMA-POC-POCv2-2007-0098R01 OMA-POC-POCv2-2007-0099R01 OMA-POC-POCv2-2007-0100R01 OMA-POC-POCv2-2007-0106R01 OMA-POC-POCv2-2007-0124 OMA-POC-POCv2-2007-0125 OMA-POC-POCv2-2007-0126 OMA-POC-POCv2-2007-0128 OMA-POC-POCv2-2007-0129 OMA-POC-POCv2-2007-0130 OMA-POC-POCv2-2007-0131R01 OMA-POC-POCv2-2007-0132 OMA-POC-POCv2-2007-0136 OMA-POC-POCv2-2007-0142 OMA-POC-POCv2-2007-0169 OMA-POC-POCv2-2007-0170 OMA-POC-POCv2-2007-0171 OMA-POC-POCv2-2007-0176 OMA-POC-POCv2-2007-0179 OMA-POC-POCv2-2007-0181R01 OMA-POC-POCv2-2007-0182 OMA-POC-POCv2-2007-0186 OMA-POC-POCv2-2007-0187 OMA-POC-POCv2-2007-0188 OMA-POC-POCv2-2007-228R01 OMA-POC-POCv2-2007-0229 OMA-POC-POCv2-2007-0230 OMA-POC-POCv2-2007-0231R01 OMA-POC-POCv2-2007-0233R01 OMA-POC-POCv2-2007-0234 OMA-POC-POCv2-2007-0236 OMA-POC-POCv2-2007-0268 Correction of 2006-1489 which had been missed</p>
	01 Mar 2007	<p>2, 6.1.3.2.2, 6.1.3.1a, 6.2.1.1, 6.2.2.1, 7.2.1.3.1, 7.2.1.3.3, 7.2.1.21, 7.2.1.8, 7.2.2.2, 7.3.1.2, 7.3.1.3, 7.3.1.4, 7.3.2.2.4, A.4.1, A.4.2</p>	<p>Inclusion of CRs: OMA-POC-POCv2-2007-0061R02 OMA-POC-POCv2-2007-0063R02 OMA-POC-POCv2-2007-0085 OMA-POC-POCv2-2007-0107R01 OMA-POC-POCv2-2007-0183R01 OMA-POC-POCv2-2007-0220R01 OMA-POC-POCv2-2007-0232 Editorial clean-up of References section (alphabetical ordering). List number sequence corrected in 7.2.1.3.3. "Simultaneous Sessions" subheader removed in A.4.1 and A.4.2 (missed when OMA-POC-POCv2-2007-228R01 was incorporated in last version).</p>

	02 Mar 2007	7.2.1.1a, E.3.1	Inclusion of CRs: OMA-POC-POCv2-2006-1263 OMA-POC-POCv2-2006-1407R01
	29 Mar 2007	All	Inclusion of CRs: OMA-POC-POCv2-2006-1355R03 OMA-POC-POCv2-2006-1492 OMA-POC-POCv2-2007-0038R02 OMA-POC-POCv2-2007-0078R05 OMA-POC-POCv2-2007-0105R01 OMA-POC-POCv2-2007-0120R02 OMA-POC-POCv2-2007-0134R02 OMA-POC-POCv2-2007-0146R03 OMA-POC-POCv2-2007-0147R02 OMA-POC-POCv2-2007-0195R03 OMA-POC-POCv2-2007-0219 OMA-POC-POCv2-2007-0221R02 OMA-POC-POCv2-2007-0226R03 OMA-POC-POCv2-2007-0261R03 OMA-POC-POCv2-2007-0292 OMA-POC-POCv2-2007-0295 OMA-POC-POCv2-2007-0297R01 OMA-POC-POCv2-2007-0302 OMA-POC-POCv2-2007-0306R01 OMA-POC-POCv2-2007-0307 OMA-POC-POCv2-2007-0336R01 OMA-POC-POCv2-2007-0337 OMA-POC-POCv2-2007-0347 OMA-POC-POCv2-2007-0348 OMA-POC-POCv2-2007-0349 OMA-POC-POCv2-2007-0381 OMA-POC-POCv2-2007-0382 OMA-POC-POCv2-2007-0383R01 OMA-POC-POCv2-2007-0388 OMA-POC-POCv2-2007-0392 OMA-POC-POCv2-2007-0421R01 OMA-POC-POCv2-2007-0422 OMA-POC-POCv2-2007-0423R01 OMA-POC-POCv2-2007-0424R01 OMA-POC-POCv2-2007-0430R01 Inclusion of changes which had been omitted when incorporating OMA-POC-POCv2-2006-1468R02 (in 6.1.3.1.a, 7.3.1.1.b and E.3.1.1). Deletion of Note 5 in 7.2.1.1a, which had been reinstated by mistake. A.12 title has been changed to "Operator specified warning message" to align with ETR and UP TS.
	30 Mar 2007	All	Inclusion of CRs: OMA-POC-POCv2-2007-0308R01 OMA-POC-POCv2-2007-0339R01 OMA-POC-POCv2-2007-0368R01 OMA-POC-POCv2-2007-0412R02 OMA-POC-POCv2-2007-0413R01 Inclusion of two changes that had been missed when incorporating OMA-POC-POCv2-2007-0337.
	02 Apr 2007	All	Fixing display problem, Figure 15. Editorial changes to some section titles (styles). Editorial corrections to list/note numbering and styles.
	26 Apr 2007	All	Inclusion of CRs: OMA-POC-POCv2-2007-0127R03 OMA-POC-POCv2-2007-0294R01

			<p>OMA-POC-POCv2-2007-0317R02 OMA-POC-POCv2-2007-0350R01 OMA-POC-POCv2-2007-0367R02 OMA-POC-POCv2-2007-0370R02 OMA-POC-POCv2-2007-0376 OMA-POC-POCv2-2007-0415 OMA-POC-POCv2-2007-0416 OMA-POC-POCv2-2007-0447 OMA-POC-POCv2-2007-0495 OMA-POC-POCv2-2007-0500 OMA-POC-POCv2-2007-0501R01 OMA-POC-POCv2-2007-0504 OMA-POC-POCv2-2007-0505R01 OMA-POC-POCv2-2007-0506R01 OMA-POC-POCv2-2007-0508R01 OMA-POC-POCv2-2007-0509R01 OMA-POC-POCv2-2007-0510 OMA-POC-POCv2-2007-0511 OMA-POC-POCv2-2007-0513 OMA-POC-POCv2-2007-0515R01 OMA-POC-POCv2-2007-0533R01 OMA-POC-POCv2-2007-0539 OMA-POC-POCv2-2007-0540 OMA-POC-POCv2-2007-0545 OMA-POC-POCv2-2007-0548R01 OMA-POC-POCv2-2007-0555R01 OMA-POC-POCv2-2007-0556R01 OMA-POC-POCv2-2007-0560R01 OMA-POC-POCv2-2007-0572R01 OMA-POC-POCv2-2007-0573 OMA-POC-POCv2-2007-0577 OMA-POC-POCv2-2007-0580 OMA-POC-POCv2-2007-0581 OMA-POC-POCv2-2007-0582 OMA-POC-POCv2-2007-0584 OMA-POC-POCv2-2007-0596 OMA-POC-POCv2-2007-0598 OMA-POC-POCv2-2007-0602R01 OMA-POC-POCv2-2007-0606R01 OMA-POC-POCv2-2007-0611R01 OMA-POC-POCv2-2007-0614 OMA-POC-POCv2-2007-0620 OMA-POC-POCv2-2007-0621 OMA-POC-POCv2-2007-0648R01 + references to subsections updated accordingly throughout the document OMA-POC-POCv2-2007-0686</p>
	04 May 2007	All	<p>Inclusion of CRs: OMA-POC-POCv2-2006-1485R04 OMA-POC-POCv2-2007-0512R01 OMA-POC-POCv2-2007-0531R01 OMA-POC-POCv2-2007-0558R01 OMA-POC-POCv2-2007-0585R01 OMA-POC-POCv2-2007-0600R01 OMA-POC-POCv2-2007-0601R01 OMA-POC-POCv2-2007-0604R02 OMA-POC-POCv2-2007-0635 OMA-POC-POCv2-2007-0647R03 OMA-POC-POCv2-2007-0649 OMA-POC-POCv2-2007-0650</p>

			<p>OMA-POC-POCv2-2007-0651R01 OMA-POC-POCv2-2007-0652R01 OMA-POC-POCv2-2007-0664 OMA-POC-POCv2-2007-0665 OMA-POC-POCv2-2007-0666 Corrections to implementation of OMA-POC-POCv2-2007-0134R02</p>
	28 May 2007	All	<p>Inclusion of CRs: OMA-POC-POCv2-2007-0290R04 OMA-POC-POCv2-2007-0420R03 OMA-POC-POCv2-2007-0431R04 OMA-POC-POCv2-2007-0484R04 OMA-POC-POCv2-2007-0507R02 OMA-POC-POCv2-2007-0553R02 OMA-POC-POCv2-2007-0559R03 OMA-POC-POCv2-2007-0561R01 OMA-POC-POCv2-2007-0570R03 OMA-POC-POCv2-2007-0615R05 OMA-POC-POCv2-2007-0636R01 OMA-POC-POCv2-2007-0657R04 OMA-POC-POCv2-2007-0663R02 OMA-POC-POCv2-2007-0674R01 OMA-POC-POCv2-2007-0694R01 OMA-POC-POCv2-2007-0695R01 OMA-POC-POCv2-2007-0700 OMA-POC-POCv2-2007-0721R01 OMA-POC-POCv2-2007-0729 OMA-POC-POCv2-2007-0732R01 OMA-POC-POCv2-2007-0734 OMA-POC-POCv2-2007-0735 OMA-POC-POCv2-2007-0738R01 OMA-POC-POCv2-2007-0740 OMA-POC-POCv2-2007-0741R01 OMA-POC-POCv2-2007-0743R01 OMA-POC-POCv2-2007-0745R02 OMA-POC-POCv2-2007-0746 OMA-POC-POCv2-2007-0747R01 OMA-POC-POCv2-2007-0758 OMA-POC-POCv2-2007-0762R03 OMA-POC-POCv2-2007-0792R01 OMA-POC-POCv2-2007-0795R02 OMA-POC-POCv2-2007-0796R01 Editorial changes to resolve CONRR comments D416 and D821.</p>
	31 May 2007		<p>Inclusion of CRs: OMA-POC-POCv2-2007-0379R04 OMA-POC-POCv2-2007-0441R05 OMA-POC-POCv2-2007-0637R02 OMA-POC-POCv2-2007-0678R02 OMA-POC-POCv2-2007-0784R03 OMA-POC-POCv2-2007-0819</p>
	22 Jun 2007		<p>Inclusion of CRs: OMA-POC-POCv2-2007-0133R01 OMA-POC-POCv2-2007-0378R04 OMA-POC-POCv2-2007-0529R04 OMA-POC-POCv2-2007-0646R03 OMA-POC-POCv2-2007-0655R03 OMA-POC-POCv2-2007-0679R02 OMA-POC-POCv2-2007-0733R01 OMA-POC-POCv2-2007-0748R03</p>

			<p>OMA-POC-POCv2-2007-0760R02 OMA-POC-POCv2-2007-0786R03 OMA-POC-POCv2-2007-0809R02 OMA-POC-POCv2-2007-0823 OMA-POC-POCv2-2007-0824R02 OMA-POC-POCv2-2007-0825 OMA OMA-POC-POCv2-2007-0826 OMA-POC-POCv2-2007-0827 OMA-POC-POCv2-2007-0834R01 OMA-POC-POCv2-2007-0842 OMA-POC-POCv2-2007-0850R01 OMA-POC-POCv2-2007-0855R01 OMA-POC-POCv2-2007-0856R01 OMA-POC-POCv2-2007-0860 OMA-POC-POCv2-2007-0872R01 OMA-POC-POCv2-2007-0874R01 OMA-POC-POCv2-2007-0875 OMA-POC-POCv2-2007-0878 OMA-POC-POCv2-2007-0880 OMA-POC-POCv2-2007-0881 OMA-POC-POCv2-2007-0888R02 OMA-POC-POCv2-2007-0891R01 OMA-POC-POCv2-2007-0893R01 OMA-POC-POCv2-2007-0894R03 OMA-POC-POCv2-2007-0895R01 OMA-POC-POCv2-2007-0896R01 OMA-POC-POCv2-2007-0911 OMA-POC-POCv2-2007-0921R02 OMA-POC-POCv2-2007-0923R01 OMA-POC-POCv2-2007-0928R01 OMA-POC-POCv2-2007-0934R01 OMA-POC-POCv2-2007-0939R01 OMA-POC-POCv2-2007-0942 OMA-POC-POCv2-2007-0951R01 OMA-POC-POCv2-2007-0955 OMA-POC-POCv2-2007-0958R01 OMA-POC-POCv2-2007-0960 OMA-POC-POCv2-2007-0962R01 OMA-POC-POCv2-2007-0963R02 OMA-POC-POCv2-2007-0967R02 OMA-POC-POCv2-2007-0968R01 OMA-POC-POCv2-2007-0973 OMA-POC-POCv2-2007-0977 OMA-POC-POCv2-2007-0978 Editorial changes to resolve CONRR comment D635.</p>
	25 Jun 2007	E.5.3	<p>Inclusion of some changes that had been missed when incorporating OMA-POC-POCv2-2007-0942.</p>
	12 Jul 2007		<p>Inclusion of CRs: OMA-POC-POCv2-2007-0821R04 OMA-POC-POCv2-2007-0953R03 OMA-POC-POCv2-2007-0992R01 OMA-POC-POCv2-2007-0993R01 OMA-POC-POCv2-2007-0995 OMA-POC-POCv2-2007-1007R02 OMA-POC-POCv2-2007-1012 OMA-POC-POCv2-2007-1013R01 OMA-POC-POCv2-2007-1018R01 Editorial correction of a reference in 6.1.2. Editorial correction of some "skip step" / "skip to" references in</p>

			7.2.1.3.2, 7.2.1.3.3 and 7.3.2.2. Editorial corrections to References section (completion of references).
	25 Jul 2007		Inclusion of CRs: OMA-POC-POCv2-2007-0983R02 OMA-POC-POCv2-2007-0968R04 OMA-POC-POCv2-2007-0969R01 OMA-POC-POCv2-2007-0984R01 OMA-POC-POCv2-2007-0996 OMA-POC-POCv2-2007-0999R02 OMA-POC-POCv2-2007-1001R01 OMA-POC-POCv2-2007-1009R03 OMA-POC-POCv2-2007-1015R02 OMA-POC-POCv2-2007-1024R01 NB: CR 0968R01 went into the 20070622 version. Later it was clarified that it had <i>not</i> been agreed in Bangkok. 0968R04 is now agreed. The differences between the two CR revisions are corrected in this version.
	02 Aug 2007		Inclusion of CRs: OMA-POC-POCv2-2007-1032 OMA-POC-POCv2-2007-1038 OMA-POC-POCv2-2007-1040R01 OMA-POC-POCv2-2007-1051 OMA-POC-POCv2-2007-1055
	08 Aug 2007		Inclusion of CRs: OMA-POC-POCv2-2007-0998R04 OMA-POC-POCv2-2007-1022R06 OMA-POC-POCv2-2007-1037R02 OMA-POC-POCv2-2007-1057 OMA-POC-POCv2-2007-1058 OMA-POC-POCv2-2007-1059 OMA-POC-POCv2-2007-1060 OMA-POC-POCv2-2007-1062 OMA-POC-POCv2-2007-1063R01 OMA-POC-POCv2-2007-1064
	22 Aug 2007		Inclusion of CRs: OMA-POC-POCv2-2007-1029R04 OMA-POC-POCv2-2007-1043R03 OMA-POC-POCv2-2007-1050R04 OMA-POC-POCv2-2007-1053R01 OMA-POC-POCv2-2007-1061R03 OMA-POC-POCv2-2007-1067 OMA-POC-POCv2-2007-1068R02 OMA-POC-POCv2-2007-1072R01 OMA-POC-POCv2-2007-1074R01 OMA-POC-POCv2-2007-1076R01 OMA-POC-POCv2-2007-1078 OMA-POC-POCv2-2007-1080R04 OMA-POC-POCv2-2007-1083 OMA-POC-POCv2-2007-1085 OMA-POC-POCv2-2007-1087R02 OMA-POC-POCv2-2007-1093
	23 Aug 2007		Inclusion of CR: OMA-POC-POCv2-2007-1084R05
	24 Aug 2007	2.1	Minor editorial changes to References section.
Candidate version: OMA-TS-PoC_ControlPlane-V2_0	02 Oct 2007	All	Status changed to Candidate by TP TP ref # OMA-TP-2007-0343R01- INP_POC_V2_0_ERP_for_Candidate_Approval
Draft versions: OMA-TS-PoC_ControlPlane-V2_0	25 Oct 2007	6.1.3.2.1, 6.1.3.2.3.1, 6.1.14, 7.1.2,	Inclusion of CRs: OMA-POC-POCv2-2007-1115R01 OMA-POC-POCv2-2007-1117R02

		7.2.1.1, 7.2.1.24, 7.2.1.25, 7.2.2.8, 7.3.1.1, 7.3.1.17, 7.3.2.1, 7.3.2.9, F.14.1, F.14.2, F.17, F.18	OMA-POC-POCv2-2007-1119R01 OMA-POC-POCv2-2007-1120 OMA-POC-POCv2-2007-1121R01 OMA-POC-POCv2-2007-1122 OMA-POC-POCv2-2007-1123R01 OMA-POC-POCv2-2007-1127R01 OMA-POC-POCv2-2007-1128 OMA-POC-POCv2-2007-1130
	12 Nov 2007	6.1.1.1, 6.1.3.1, 6.1.3.1a, 6.1.4.1, 6.2.1.1, 6.2.1.1a, 6.2.2.3, 7.3.2.1a, F1	Inclusion of CRs: OMA-POC-POCv2-2007-1098R02 OMA-POC-POCv2-2007-1100R01 OMA-POC-POCv2-2007-1116R01
Candidate version: OMA-TS-PoC_ControlPlane-V2_0	11 Dec 2007	n/a	Status changed to Candidate by TP TP ref # OMA-TP-2007-0468-INP_PoC_V2_0_ERP_for_Notification
Draft versions: OMA-TS-PoC_ControlPlane-V2_0	19 Dec 2007	All	Inclusion of CRs: OMA-POC-POCv2-2007-1109R03 OMA-POC-POCv2-2007-1133R04 OMA-POC-POCv2-2007-1134R01 OMA-POC-POCv2-2007-1135R04 OMA-POC-POCv2-2007-1150 OMA-POC-POCv2-2007-1158 OMA-POC-POCv2-2007-1159 OMA-POC-POCv2-2007-1164 OMA-POC-POCv2-2007-1168 OMA-POC-POCv2-2007-1174
	04 Feb 2008	All	Inclusion of CRs: OMA-POC-POCv2-2007-1132R03 OMA-POC-POCv2-2007-1149R01
Candidate version: OMA-TS-PoC_ControlPlane-V2_0	26 Feb 2008	n/a	Status changed to Candidate by TP TP ref # OMA-TP-2008-0098-INP_Push_to_talk_over_Cellular_V2_0_ERP_for_Notification
Draft version: OMA-TS-PoC_ControlPlane-V2_0	06 Mar 2008	All	Inclusion of CRs: OMA-POC-POCv2-2007-1167R01 OMA-POC-POCv2-2008-0034R01 OMA-POC-POCv2-2008-0005 OMA-POC-POCv2-2008-0018R02 OMA-POC-POCv2-2008-0020 OMA-POC-POCv2-2008-0025 OMA-POC-POCv2-2008-0027 OMA-POC-POCv2-2008-0036R01
Candidate version: OMA-TS-PoC_ControlPlane-V2_0	21 Apr 2008	n/a	Status changed to Candidate by TP TP ref # OMA-TP-2008-0169-INP_Push_to_talk_over_Cellular_V2_0_ERP_for_Notification
Draft version: OMA-TS-PoC_ControlPlane-V2_0	25 Apr 2008	All	Inclusion of CRs: OMA-POC-POCv2-2008-0026R02 OMA-POC-POCv2-2008-0023R03 OMA-POC-POCv2-2007-1176R02 OMA-POC-POCv2-2008-0019R04 OMA-POC-POCv2-2008-0024R01 OMA-POC-POCv2-2008-0038 OMA-POC-POCv2-2008-0040 OMA-POC-POCv2-2008-0041 OMA-POC-POCv2-2008-0049 OMA-POC-POCv2-2008-0003R03 CR_CP_Multiple_PoC_Addresses_solved_by_reg_event

			Editorial change to AC reference.
Draft version: OMA-TS-PoC_ControlPlane-V2_0	30 Apr 2008	All	Editorial corrections following PoC R&A comments.
Candidate version: OMA-TS-PoC_ControlPlane-V2_0	07 May 2008	n/a	Status changed to Candidate by TP TP ref # OMA-TP-2008-0189- INP_Push_to_talk_over_Cellular_V2_0_ERP_for_Notification