



# **OMA SIMPLE IM Charging Specification**

## **Candidate Version 1.0 – 16 Aug 2007**

---

**Open Mobile Alliance**  
OMA-TS-SIMPLE\_IM\_Charging-V1\_0-20070816-C

Use of this document is subject to all of the terms and conditions of the Use Agreement located at <http://www.openmobilealliance.org/UseAgreement.html>.

Unless this document is clearly designated as an approved specification, this document is a work in process, is not an approved Open Mobile Alliance™ specification, and is subject to revision or removal without notice.

You may use this document or any part of the document for internal or educational purposes only, provided you do not modify, edit or take out of context the information in this document in any manner. Information contained in this document may be used, at your sole risk, for any purposes. You may not use this document in any other manner without the prior written permission of the Open Mobile Alliance. The Open Mobile Alliance authorizes you to copy this document, provided that you retain all copyright and other proprietary notices contained in the original materials on any copies of the materials and that you comply strictly with these terms. This copyright permission does not constitute an endorsement of the products or services. The Open Mobile Alliance assumes no responsibility for errors or omissions in this document.

Each Open Mobile Alliance member has agreed to use reasonable endeavors to inform the Open Mobile Alliance in a timely manner of Essential IPR as it becomes aware that the Essential IPR is related to the prepared or published specification. However, the members do not have an obligation to conduct IPR searches. The declared Essential IPR is publicly available to members and non-members of the Open Mobile Alliance and may be found on the “OMA IPR Declarations” list at <http://www.openmobilealliance.org/ipr.html>. The Open Mobile Alliance has not conducted an independent IPR review of this document and the information contained herein, and makes no representations or warranties regarding third party IPR, including without limitation patents, copyrights or trade secret rights. This document may contain inventions for which you must obtain licenses from third parties before making, using or selling the inventions. Defined terms above are set forth in the schedule to the Open Mobile Alliance Application Form.

NO REPRESENTATIONS OR WARRANTIES (WHETHER EXPRESS OR IMPLIED) ARE MADE BY THE OPEN MOBILE ALLIANCE OR ANY OPEN MOBILE ALLIANCE MEMBER OR ITS AFFILIATES REGARDING ANY OF THE IPR'S REPRESENTED ON THE “OMA IPR DECLARATIONS” LIST, INCLUDING, BUT NOT LIMITED TO THE ACCURACY, COMPLETENESS, VALIDITY OR RELEVANCE OF THE INFORMATION OR WHETHER OR NOT SUCH RIGHTS ARE ESSENTIAL OR NON-ESSENTIAL.

THE OPEN MOBILE ALLIANCE IS NOT LIABLE FOR AND HEREBY DISCLAIMS ANY DIRECT, INDIRECT, PUNITIVE, SPECIAL, INCIDENTAL, CONSEQUENTIAL, OR EXEMPLARY DAMAGES ARISING OUT OF OR IN CONNECTION WITH THE USE OF DOCUMENTS AND THE INFORMATION CONTAINED IN THE DOCUMENTS.

© 2007 Open Mobile Alliance Ltd. All Rights Reserved.

Used with the permission of the Open Mobile Alliance Ltd. under the terms set forth above.

# Contents

1.	SCOPE.....	6
2.	REFERENCES .....	7
2.1	NORMATIVE REFERENCES.....	7
2.2	INFORMATIVE REFERENCES.....	7
3.	TERMINOLOGY AND CONVENTIONS.....	8
3.1	CONVENTIONS.....	8
3.2	DEFINITIONS.....	8
3.3	ABBREVIATIONS.....	8
4.	INTRODUCTION .....	9
5.	SIMPLE IM CHARGING ARCHITECTURE .....	10
6.	IM CHARGING PRINCIPLES AND SCENARIOS.....	11
6.1	IM CHARGING PRINCIPLES .....	11
6.1.1	Charging principles for IM Events.....	11
6.1.2	Charging principles for IM Sessions.....	11
6.2	IM OFFLINE CHARGING SCENARIOS.....	12
6.2.1	Basic principles.....	12
6.2.2	Offline Charging for IM Events.....	13
6.2.2.1	<i>Pager mode message to a single user</i> .....	13
6.2.2.2	<i>Pager mode message to an ad hoc or pre-defined group</i> .....	14
6.2.2.3	<i>Large message</i> .....	16
6.2.2.4	<i>Large message to an ad-hoc or predefined group</i> .....	17
6.2.2.5	<i>Conversation History Retrieval</i> .....	18
6.2.2.6	<i>Deferred Message Retrieval</i> .....	19
6.2.2.7	<i>Deferred Message Push</i> .....	20
6.2.3	Offline Charging for IM sessions.....	21
6.2.3.1	<i>Successful one-to-one IM session Establishment</i> .....	21
6.2.3.2	<i>Successful conference IM session Establishment</i> .....	22
6.2.3.3	<i>Joining or departure of a conference participant</i> .....	22
6.2.3.4	<i>Session Modification</i> .....	23
6.2.3.5	<i>Message exchange during a chat session</i> .....	24
6.2.3.6	<i>IM Session end</i> .....	25
6.3	IM ONLINE CHARGING SCENARIOS.....	27
6.3.1	Basic principles.....	27
6.3.2	Online Charging for IM Events .....	29
6.3.2.1	<i>Pager mode message to a single user</i> .....	29
6.3.2.2	<i>Pager mode message to an ad hoc or predefined group</i> .....	31
6.3.2.3	<i>Large message</i> .....	32
6.3.2.4	<i>Large message to a predefined or ad hoc group</i> .....	34
6.3.2.5	<i>Conversation History Retrieval</i> .....	36
6.3.2.6	<i>Deferred Message Retrieval</i> .....	37
6.3.2.7	<i>Deferred Message Push</i> .....	38
6.3.3	Online Charging for IM sessions .....	40
6.3.3.1	<i>Successful one-to-one IM session Establishment</i> .....	40
6.3.3.2	<i>Successful conference IM session Establishment</i> .....	41
6.3.3.3	<i>Joining or departure of a conference participant</i> .....	41
6.3.3.4	<i>Session modification</i> .....	42
6.3.3.5	<i>Message exchange during a chat session</i> .....	44
6.3.3.6	<i>IM Session end</i> .....	45
6.3.3.7	<i>Participant number based online charging for session owner</i> .....	46
7.	DEFINITION OF CHARGING INFORMATION.....	49
7.1	MAPPING OF IM PARAMETERS TO OMA CHARGING DATA ELEMENTS .....	49
APPENDIX A.	CHANGE HISTORY (INFORMATIVE).....	52
A.1	APPROVED VERSION HISTORY .....	52
A.2	DRAFT/CANDIDATE VERSION 1.0 HISTORY .....	52

APPENDIX B.....	54
B.1  EXAMPLE 1 .....	54
B.2  EXAMPLE 2 .....	55
B.3  EXAMPLE 3 .....	55
B.4  EXAMPLE 4 .....	56
B.5  EXAMPLE 5 .....	56

## Figures

Figure 1: Charging architecture for IM charging .....	10
Figure 2: Offline Charging for Pager Mode Messaging .....	14
Figure 3: Offline Charging for Pager Mode Messaging to AdHoc or pre-defined group .....	15
Figure 4: Offline Charging for Large Mode Messaging.....	16
Figure 5: Offline Charging for Large mode message to an ad hoc or predefined group .....	17
Figure 6: Offline Charging for Conversation History Retrieval .....	18
Figure 7: Offline charging for retrieval of deferred messages.....	19
Figure 8: Offline charging for deferred message push .....	20
Figure 9: Offline Charging for one-to-one IM Session Establishment.....	21
Figure 10: Offline Charging for conference IM Session Establishment .....	22
Figure 11: Offline Charging for Arrival or departure of a conference participant.....	23
Figure 12: Offline Charging for session modification .....	24
Figure 13: Offline Charging for IM Session message exchange .....	25
Figure 14: Offline Charging for IM Session end (client terminating).....	26
Figure 15: Offline charging for IM Session end (Server terminating).....	27
Figure 16: Online Charging for Pager Mode Messages to a Single User .....	30
Figure 17: Online Charging for Pager Mode Message to an ad hoc or predefined group .....	31
Figure 18: Online Charging for Large message .....	32
Figure 19: Online Charging for Large message to an ad hoc or predefined group .....	34
Figure 20: Online charging for Conversation History retrieval .....	36
Figure 21: Online charging for retrieving deferred messages .....	37
Figure 22: online charging for pushing deffered messages .....	38
Figure 23: Online Charging for IM Session Establishment .....	40
Figure 24: Online Charging for Conference IM Session Establishment.....	41
Figure 25: Online Charging for joining or departure of a conference participant.....	42
Figure 26: Online Charging for session modification .....	43
Figure 27: Online Charging for message exchange during IM session .....	44

Figure 28: Online Charging for IM Session end (client terminating) .....45

Figure 29: Online Charging for IM Session end (Server terminating) .....46

Figure 30: Participant number based Online Charging for session owner .....47

## Tables

Table 1: Charging Request Message Triggered by SIP Methods or MSRP Messages for SIMPLE IM Server .....13

Table 2: The Charging Request Messages Triggered by SIP Methods or MSRP Messages for SIMPLE IM Server ....29

Table 3: Structure of the IM\_Information .....51

# 1. Scope

This document specifies the use of OMA Charging Enabler to realise the offline and online charging requirements of OMA SIMPLE IM Enabler. The OMA Charging Enabler defines a set of interfaces that are utilised by the other Enablers to fulfil their charging requirements. The interfaces are specified in [OMA-AD-Charging-V1\_0]. This document defines how, when and by which entities charging is triggered and which function invokes charging over the OMA Charging Enabler interfaces. This document also defines the data that will be exchanged during the process.

This document specifies in detail:

- The charging models for the OMA SIMPLE IM enabler,
- The logical messages and message types used on CH-1 and CH-2 interfaces,
- The flow of messages between the Charging Enabler User and the Charging Enabler with regard to the IM Service and applicable IM scenarios,
- Mapping of the IM parameters to the OMA Charging Data Elements

---

## 2. References

### 2.1 Normative References

- [RFC2119] “Key words for use in RFCs to Indicate Requirement Levels”, S. Bradner, March 1997,  
[URL:http://www.ietf.org/rfc/rfc2119.txt](http://www.ietf.org/rfc/rfc2119.txt)
- [SCRRULES] “SCR Rules and Procedures”, Open Mobile Alliance™, OMA-ORG-SCR\_Rules\_and\_Procedures,  
[URL:http://www.openmobilealliance.org/](http://www.openmobilealliance.org/)
- [IM-TS] “Instant Messaging using SIMPLE”, Open Mobile Alliance™,  
OMA-TS\_SIMPLE\_IM-V1\_0, URL: <http://www.openmobilealliance.org/>
- [IM-AD] “Instant Messaging Architecture ”, Open Mobile Alliance™,  
OMA-AD\_SIMPLE\_IM-V1\_0, URL: <http://www.openmobilealliance.org/>

### 2.2 Informative References

- [OMA-DICT] “Dictionary for OMA Specifications”, Version x.y, Open Mobile Alliance™,  
OMA-ORG-Dictionary-Vx\_y, [URL:http://www.openmobilealliance.org/](http://www.openmobilealliance.org/)

## 3. Terminology and Conventions

### 3.1 Conventions

The key words “MUST”, “MUST NOT”, “REQUIRED”, “SHALL”, “SHALL NOT”, “SHOULD”, “SHOULD NOT”, “RECOMMENDED”, “MAY”, and “OPTIONAL” in this document are to be interpreted as described in [RFC2119].

All sections and appendixes, except “Scope” and “Introduction”, are normative, unless they are explicitly indicated to be informative.

### 3.2 Definitions

<b>CH-1 EventRequest</b>	Refers to the EventRequest defined in OMA Offline charging TS
<b>CH-1 StartRequest</b>	Refers to the StartRequest defined in OMA Offline charging TS
<b>CH-1 InterimRequest</b>	Refers to the InterimRequest defined in OMA Offline charging TS
<b>CH-1 StopRequest</b>	Refers to the StopRequest defined in OMA Offline charging TS
<b>CH-1 Response</b>	Refers to the Charging Response Message defined in OMA Offline charging TS
<b>CH-2 Initial Request</b>	Refers to the Initial Request defined in OMA Online Charging TS
<b>CH-2 Update Request</b>	Refers to the Update Request defined in OMA Online Charging TS
<b>CH-2 Termination Request</b>	Refers to the Termination Request defined in OMA Online Charging TS
<b>CH-2 Response</b>	Refers to the Charging Response Message defined in OMA Online charging TS
<b>CH-2 Balance Check Request</b>	Refers to the Balance Check Request defined in OMA Online Charging TS
<b>IM Session</b>	Exchange of near real-time messages where the senders and receivers join together for a period of time (session). The session is established at some moment in time, continues for a finite duration and then is dissolved. Messages exchanged are associated together in the context of this session.

### 3.3 Abbreviations

<b>IM</b>	Instant Messaging
<b>OMA</b>	Open Mobile Alliance
<b>SIMPLE</b>	SIP for Instant Messaging and Presence Leveraging Extensions
<b>SIP</b>	Session Initiation Protocol



## 4. Introduction

The OMA Charging Enabler provides offline and online charging specifications for the other OMA enablers. This document is part of the SIMPLE IM enabler and specifies charging for the OMA IM service.

## 5. SIMPLE IM Charging Architecture

The OMA SIMPLE IM service architecture is described in [IM-AD]. Figure 1 depicts the high-level OMA SIMPLE IM charging architecture.

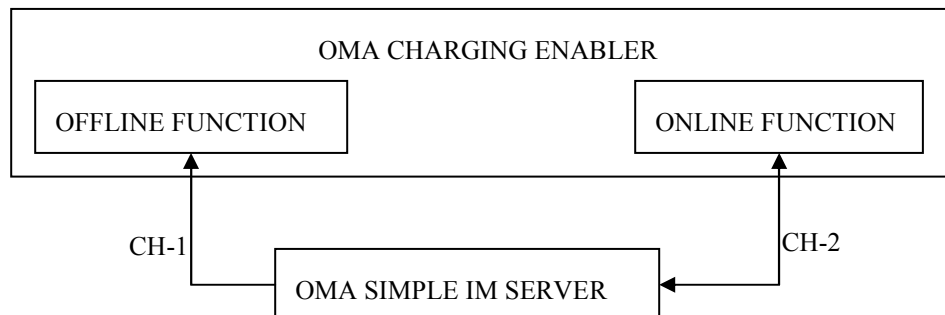

**Figure 1: Charging architecture for IM charging**

In this figure:

- CH-1 is Offline charging reference point between SIMPLE IM Server and the Offline Function of the Charging Enabler.
- CH-2 is Online charging reference point between SIMPLE IM Server and the Online Function of the Charging Enabler.

The OMA SIMPLE IM Server MAY comprise of the Charging Enabler User, an integrated function that monitors and generates the charging events, sends the charging requests to the Charging Enabler and receives the responses from the Charging Enabler, over the CH-1 or the CH-2 interface, or both.

NOTE: No distinction is made between the individual IM functions such as the controlling and the participating functions, i.e. both functions are referred to as IM Server for the purposes.

The OMA SIMPLE IM Server SHALL generate charging requests for all the users registered to that Server.

## 6. IM charging principles and scenarios

OMA SIMPLE IM charging is based on the concept of charging for the usage of the service. The criteria for charging for the service provided may vary, i.e. charging may be based on sessions, duration of the session, number of participants, numbers of messages, size of messages, etc. or a combination of such criteria.

OMA SIMPLE IM charging SHALL support both charging models, i.e. an Event-based charging model that charges for session unrelated events, and a Session-based charging model, that charges for the an OMA SIMPLE IM sessions. These models are applicable for both online and offline charging procedures.

The IM Server may process a Large message or a message within an IM session which MAY be broken down into smaller chunks for the purposes of transmission. In such cases, the IM Server may receive multiple intermediate [MSRP 200 OK] messages; however, these [MSRP 200 OK] messages SHALL NOT trigger a charging request message. In this case, the IM Server MAY trigger a charging request message only after receiving the last [MSRP 200 OK], i.e. on determining that the transmission of the chunked messages is completed.

### 6.1 IM charging principles

#### 6.1.1 Charging principles for IM Events

The OMA Charging Enabler User SHALL use Event-based charging to enable charging for the following IM session unrelated procedures.

- Sending or receiving of pager mode message(s) to a single user or to a predefined/ad-hoc group. Deferred messages shall be considered as successful. Unsuccessful pager mode messages sent to a single user or to a predefined/ad-hoc group SHALL be reported (related to charging scenarios 1.x, 2.x defined in [IM-TS]).
- Sending or receiving of Large message to a single user or to a predefined/ad-hoc group. Unsuccessful Large message to a single user or to a predefined/ad-hoc group SHALL be reported (related to charging scenarios 3, 4 defined in [IM-TS]).
- Retrieval of conversation history (related to charging scenario 9.4 defined in [IM-TS]).
- Retrieval of one or all deferred messages (related to charging scenario 10.1 defined in [IM-TS]).
- Having all deferred messages pushed (related to charging scenario 10.3 defined in [IM-TS])

#### 6.1.2 Charging principles for IM Sessions

Charging requests for an OMA SIMPLE IM session SHALL be generated by the IM Server for the participants being served by it.

The charged parties may be any of the OMA SIMPLE IM participants, depending on the role of the participant. These roles are:

- IM participant.
- IM inviting user or group owner (in the case of OMA SIMPLE IM sessions)

Information about the OMA SIMPLE IM session SHALL be collected by the IM Server. Charging SHALL be done according to the following types of OMA SIMPLE IM sessions [IM-AD], if such information is available:

- 1-1 IM session peer-to-peer,
- 1-1 IM session through different OMA SIMPLE IM servers,
- IM group session,
  - Ad-hoc IM group session,

- Pre-defined IM group session.

OMA SIMPLE IM session owner and/or participants MAY be charged based on, e.g.:

1. IM session duration,
2. Number of participants,
3. Volume of messages sent and/or received by the participant,
4. Number of messages sent and/or received by the participant,

or a combination of the above.

In addition the following parameters MAY be considered for a final charge:

- a) Number of exploded messages,
- b) Identity of the network hosting the IM Server where messages are exploded.

Online and offline specific charging details are given in the subsequent chapters.

## 6.2 IM Offline Charging Scenarios

### 6.2.1 Basic principles

The charging models as given in chapter 6 SHALL be supported for offline charging.

These charging requests SHALL contain distinct service usage data for any of the described sub-services. IM usage data in the charging requests SHALL comprise the duration, volume and number of messages.

OMA SIMPLE IM sessions MAY be charged either using the Event-based messages (EventRequest) or the Session-based messages (StartRequest, InterimRequest (zero or more), and StopRequest). Event-based requests SHALL be generated for pager message and large message mode delivery.

InterimRequest and StopRequest messages SHALL be generated for the IM sessions in accordance to the defined triggers for offline charging. The generation of InterimRequest(s) SHALL be governed in accordance to triggers defined for Session-based requests, or on the values received in the charging responses, or based on locally configured values.

The charging request messages sent from a SIMPLE IM Server are described in the following table. The table summarises the SIP or MSRP messages which may trigger the charging messages.

OMA Charging Message	Triggering SIP Method /MSRP Message
StartRequest	SIP 200 OK to Initial SIP INVITE in one-to-one IM session Establishment SIP 200 OK to Initial SIP INVITE in successful conference IM Session Establishment
InterimRequest	SIP 200 OK/SIP BYE indicating an arrival or departure of a conference participant SIP re-INVITE in Session modification The final MSRP 200 OK acknowledging a MSRP SEND in IM Session Message exchange MSRP error message in IM Session Message exchange
StopRequest	SIP BYE received by IM Server in IM Session End signifying the end of the session. SIP BYE generated by the IM Server to close the session.
EventRequest	SIP 200 OK acknowledging a SIP MESSAGE is successfully accepted in Pager mode message transmission SIP BYE sent from IM Server in deferred message push. SIP BYE sent from IM Server in deferred message retrieval The final MSRP 200 OK acknowledging a MSRP SEND of a Large message. MSRP 200 OK acknowledging MSRP SEND in Conversation History Retrieval MSRP error message during the transmission of a Large message.

**Table 1: Charging Request Message Triggered by SIP Methods or MSRP Messages for SIMPLE IM Server**

## 6.2.2 Offline Charging for IM Events

### 6.2.2.1 Pager mode message to a single user

Figure 2 shows the charging request transactions between the Charging Enabler User in the IM Server and the Charging Enabler for the Pager mode message delivery. The charging principle is the same whether the receiving client belongs to the same network or not and is online or not (deferred message).

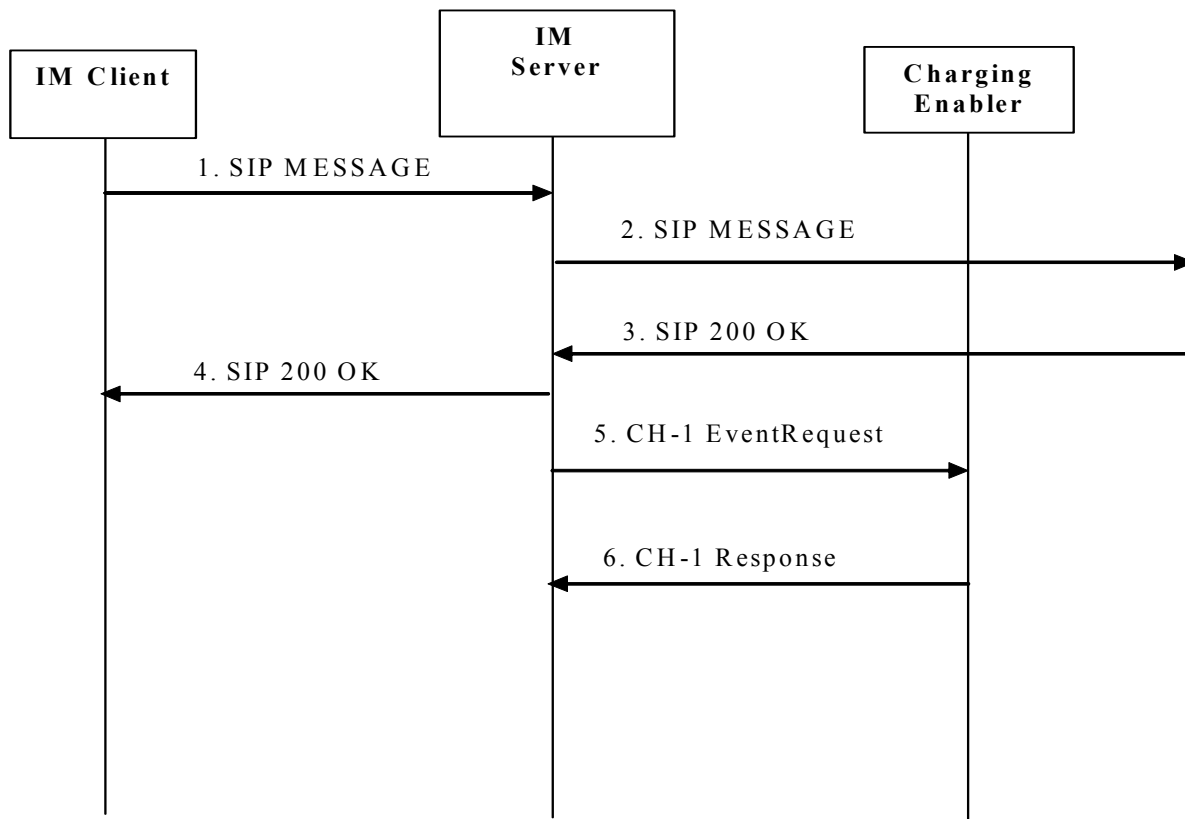
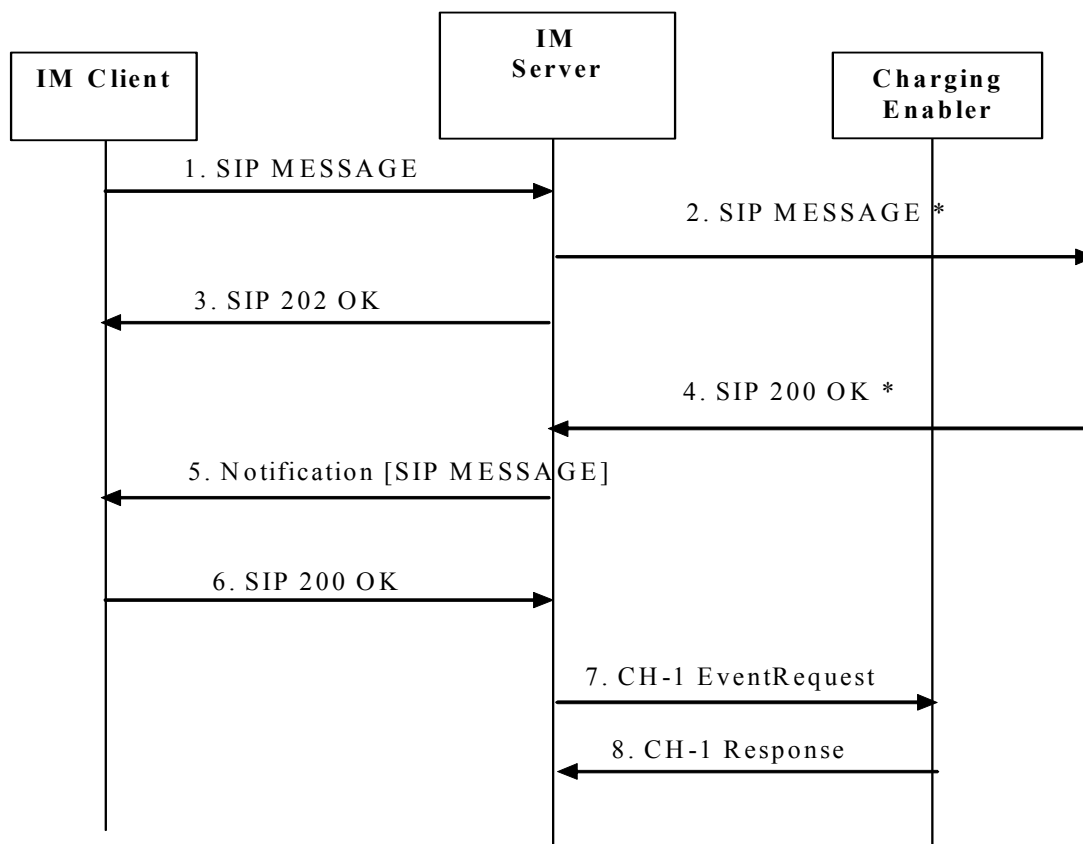

**Figure 2: Offline Charging for Pager Mode Messaging**

1. The IM Server receives a [SIP MESSAGE] from the IM Client.
2. The IM Server forwards the [SIP MESSAGE] to the recipient.
3. The IM Server receives a [SIP 200 OK] or any SIP error.
4. The IM Server forwards the [SIP 200 OK] or any SIP error to the IM Client.
5. In the case of an IM Server forwarding [SIP 200 OK], the Charging Enabler User SHALL trigger a CH-1 EventRequest message towards the Charging Enabler.
6. The Charging Enabler acknowledges with a CH-1 Response message.

### 6.2.2.2 Pager mode message to an ad hoc or pre-defined group

Figure 3 shows the charging request transactions between the Charging Enabler User in the IM Server and the Charging Enabler for the Pager mode message delivery to an ad-hoc or pre-defined group. The charging principle is the same whether the receiving client belongs to the same network or not and is online or not (deferred message).

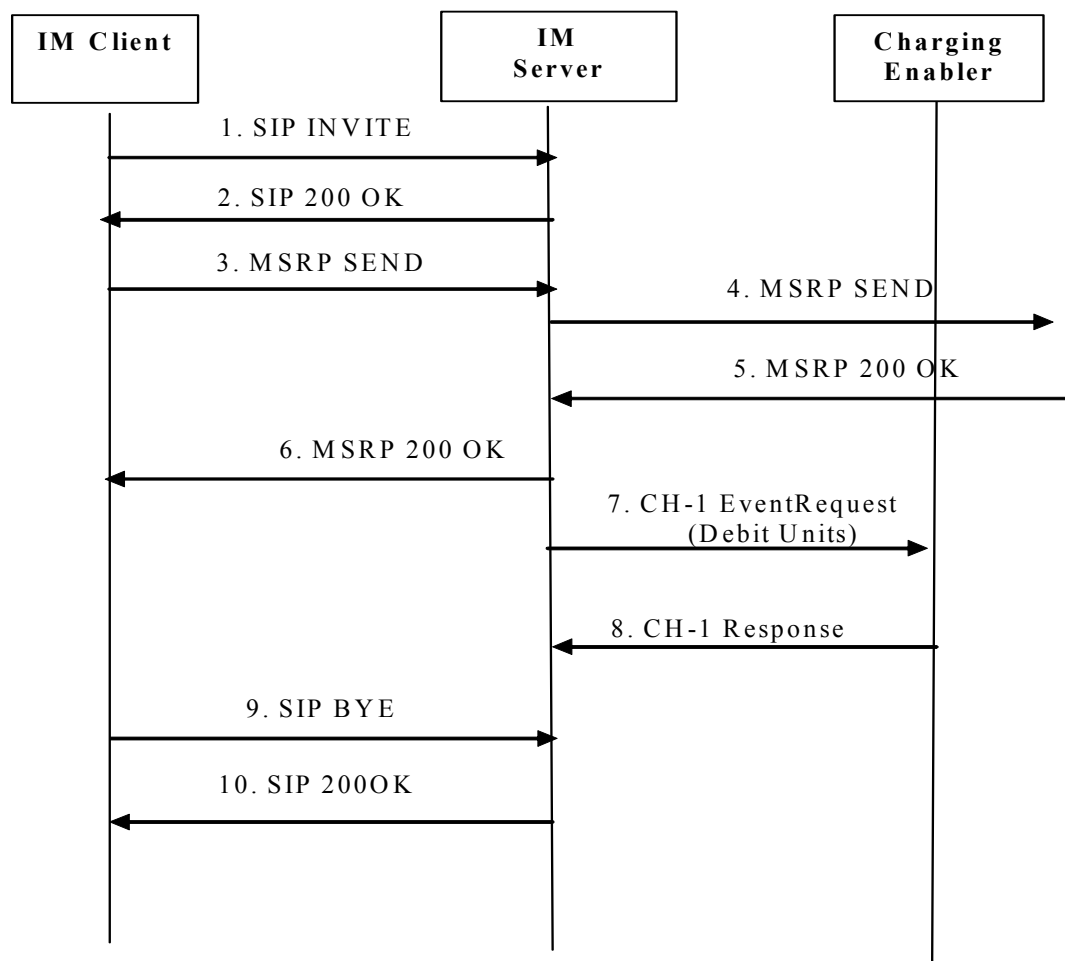

**Figure 3: Offline Charging for Pager Mode Messaging to AdHoc or pre-defined group**

1. The IM Server receives a [SIP MESSAGE] from the IM Client.
2. The IM Server forwards the [SIP MESSAGE] to each of the recipients in the ad-hoc or predefined group.
3. The IM Server sends a [SIP 202 OK] to the IM Client.
4. The IM Server receives a [SIP 200 OK] or any SIP error response from each of the recipients in the ad-hoc or predefined group.
5. At the timer expiration the IM Server sends the aggregated delivery notifications to the originating client in a [SIP MESSAGE].
6. The IM Server receives a [SIP 200 OK] confirmation from the IM Client.
7. The Charging Enabler User in the IM Server, after receiving a [SIP 200 OK] from the IM client, SHALL trigger a CH-1 EventRequest message towards the Charging Enabler.
8. The Charging Enabler acknowledges with a CH-1 Response message.

### 6.2.2.3 Large message

Figure 4 shows the charging request transactions between the Charging Enabler User in the IM Server and the Charging Enabler for the Large message delivery. The charging principle is the same whether the receiving client belongs to the same network or not and is online or not (deferred message).



**Figure 4: Offline Charging for Large Mode Messaging**

1. The IM Server receives a [SIP INVITE] from the IM Client.
2. The IM Server confirms with a [SIP 200 OK].
3. The IM Client sends a large message over [MSRP SEND] to the IM Server
4. The IM Server forwards the [MSRP SEND] to the recipient.
5. The IM Server receives a [MSRP 200 OK] from the recipient.
6. The IM Server forwards the [MSRP 200 OK] to the IM Client.



7. The Charging Enabler User in the IM Server SHALL trigger a CH-1 EventRequest (Debit Units) message towards the Charging Enabler. The charging message SHALL be triggered when one of the following has occurred:
  - [MSRP 200 OK] response indicating the receipt of the complete message by a recipient (i.e. all chunks within the MSRP )
  - a MSRP error message is received
  - timeout has been reached.
8. The Charging Enabler acknowledges with a CH-1 Response message.
9. The IM Client triggers a [SIP BYE] towards the IM Server.
10. The IM Server responds with a [SIP 200 OK].

#### 6.2.2.4 Large message to an ad-hoc or predefined group

Figure 5 shows the Charging Request transactions between the Charging Enabler User in an IM Server and Charging Enabler for the Large mode message delivery to a predefined or ad hoc group. Each Large mode group message SHALL be treated independently.

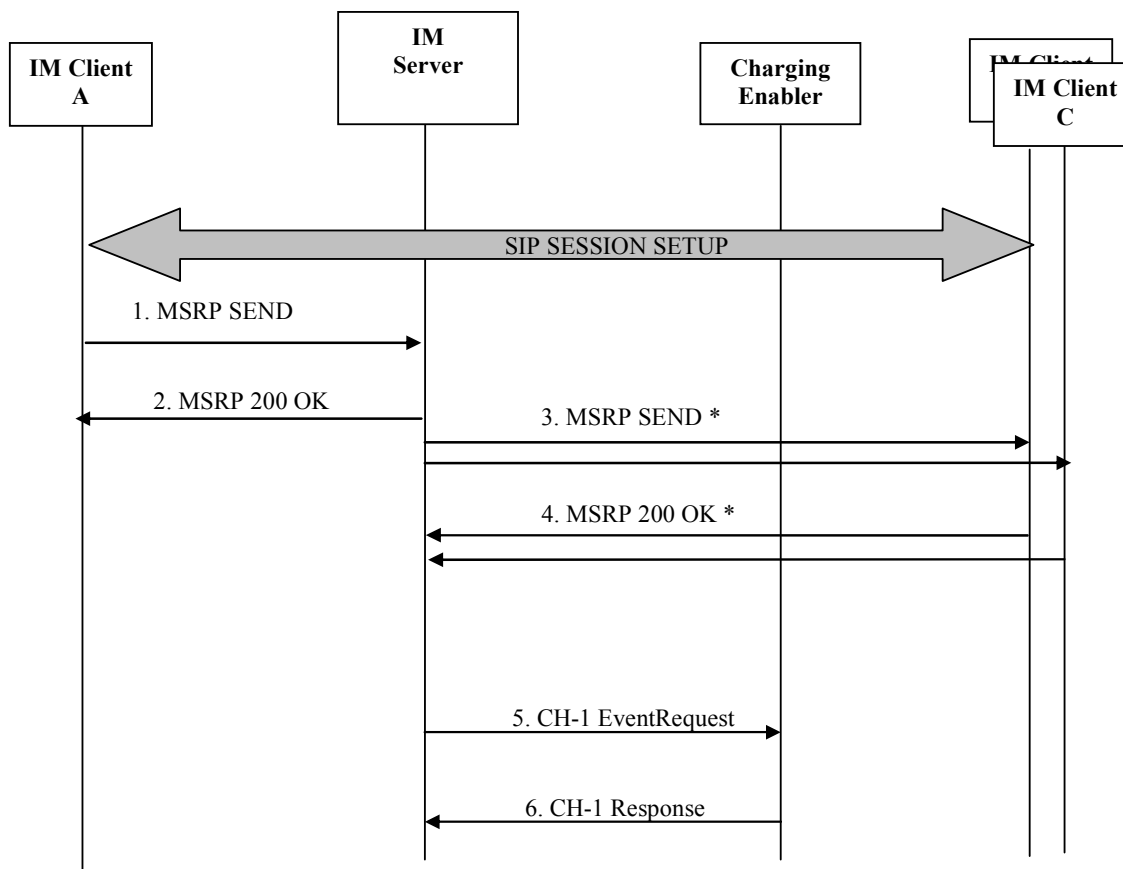

**Figure 5: Offline Charging for Large mode message to an ad hoc or predefined group**

1. The IM Server receives a [MSRP SEND] from the IM Client
2. The IM Server sends a [MSRP 200 OK] confirming the receipt of the message.

3. The IM Server forwards the [MSRP SEND] to the recipients.
4. The IM Server receives the corresponding [MSRP 200 OK] messages.
5. The Charging Enabler User in the IM Server SHALL trigger a CH-1 EventRequest message towards the Charging Enabler in the following cases:
  - all responses have been received ([MSRP 200 OK] or MSRP error message)
  - a timeout for the response message has been reached.
6. The Charging Enabler acknowledges with a CH-1 Response message.

### 6.2.2.5 Conversation History Retrieval

Figure 6 shows the charging request transactions between the Charging Enabler User in the IM Server and the Charging Enabler for the conversation history retrieval.

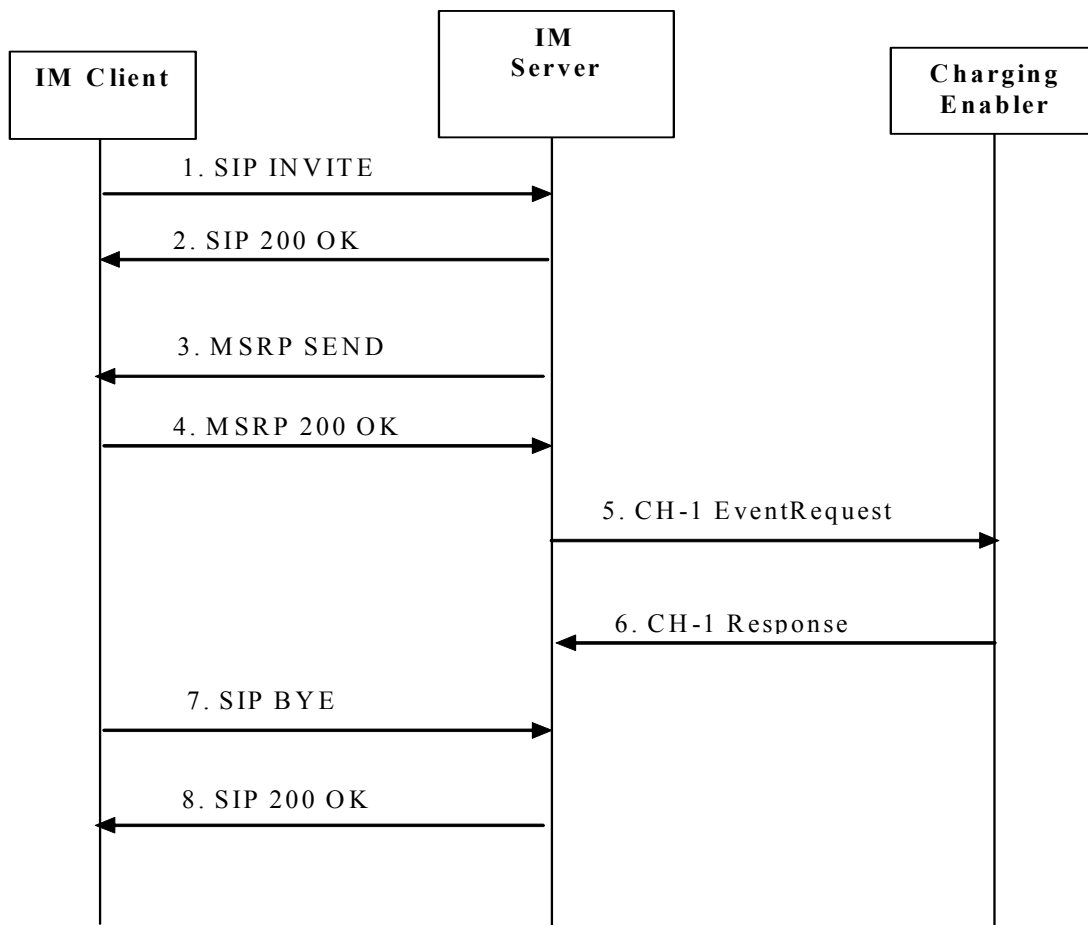
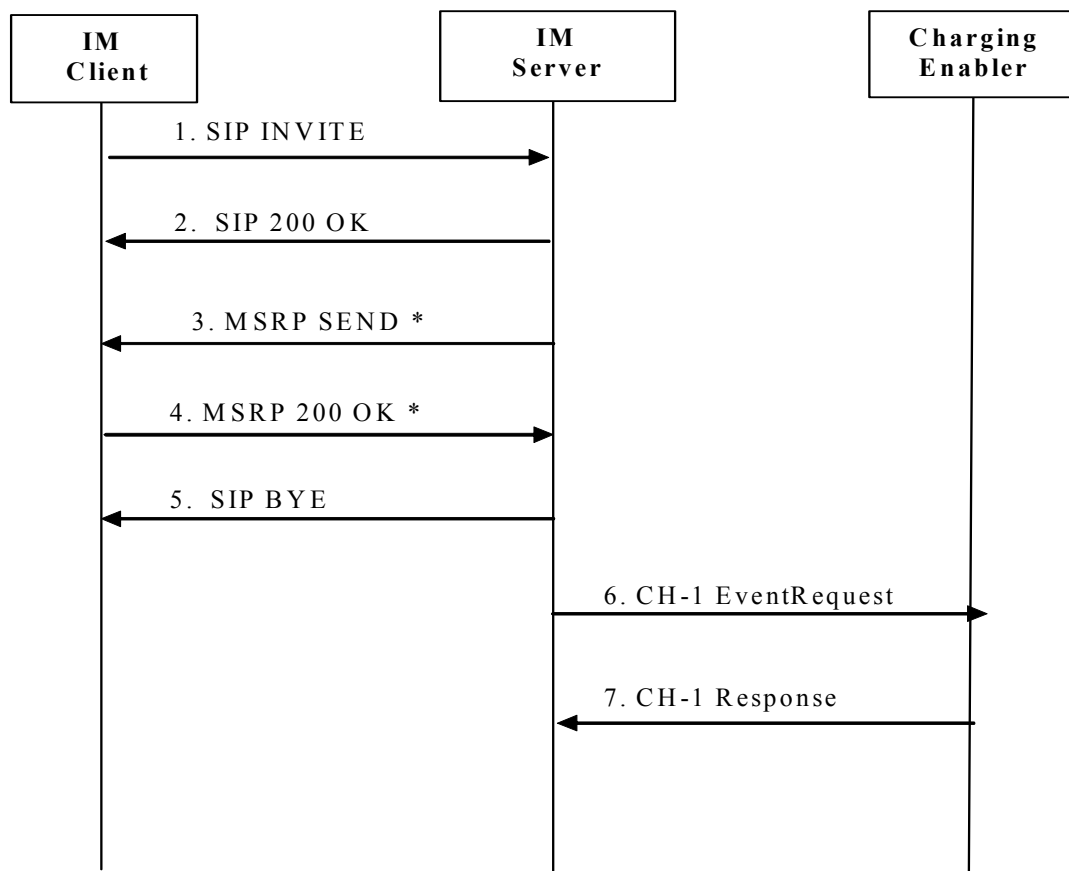

**Figure 6: Offline Charging for Conversation History Retrieval**

1. The IM Server receives a [SIP INVITE] from the IM Client.
2. The IM Server confirms with a [SIP 200 OK].
3. The IM Server sends saved history over MSRP to the IM Client [MSRP SEND].
4. The IM Client confirms with a [MSRP 200 OK].

5. The Charging Enabler User in the IM Server, after receiving a [MSRP 200 OK] from the IM client, SHALL trigger a CH-1 EventRequest message towards the Charging Enabler.
6. The Charging Enabler acknowledges with a CH-1 Response message.
7. The IM Client triggers a [SIP BYE] towards the IM Server.
8. The IM Server confirms with a [SIP 200 OK].

### 6.2.2.6 Deferred Message Retrieval



**Figure 7: Offline charging for retrieval of deferred messages**

NOTE: The last [SIP 200 OK] response from the IM Client has been omitted from figure; however, can occur at any point after the [SIP BYE] is received from IM Client.

1. The IM Server receives a [SIP INVITE] from the IM Client.
2. The IM Server sends a confirmation [SIP 200 OK] to the IM Client.
3. The IM Server sends one or more [MSRP SEND] containing the deferred message(s).
4. The IM Server receives one or more [MSRP 200 OK] from the IM Client.

5. The IM Server sends a [SIP BYE] to the IM Client.
6. The Charging Enabler User in the IM Server, after sending a [SIP BYE] to the IM client, SHALL trigger a CH-1 EventRequest message towards the Charging Enabler.
7. The Charging Enabler acknowledges with a CH-1 Response message.

### 6.2.2.7 Deferred Message Push

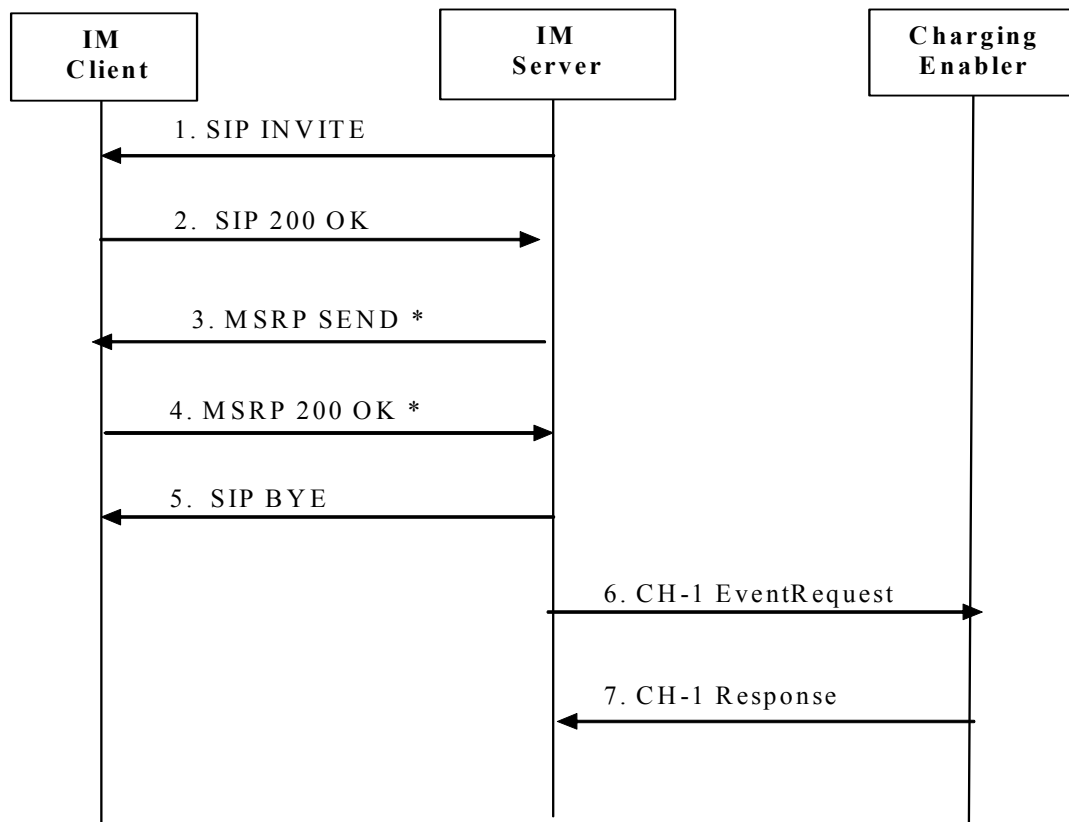

**Figure 8: Offline charging for deferred message push**

NOTE: The last [SIP 200 OK] response from the IM Client has been omitted from figure; however can occur at any point after the [SIP BYE] is sent to the IM Client.

1. The IM Server sends a [SIP INVITE] to the IM Client.
2. The IM Server receives a confirmation [SIP 200 OK] from the IM Client.
3. The IM Server sends one or more [MSRP SEND] containing the deferred message(s).
4. The IM Server receives one or more [MSRP 200 OK] from the Client.

5. The IM Server sends a [SIP BYE] to the IM Client.
6. The Charging Enabler User in the IM Server, after sending a [SIP BYE] to the IM client, SHALL trigger a CH-1 EventRequest message towards the Charging Enabler.
7. The Charging Enabler acknowledges with a CH-1 Response message.

## 6.2.3 Offline Charging for IM sessions

### 6.2.3.1 Successful one-to-one IM session Establishment

Figure 9 shows the charging request transactions between the Charging Enabler User in the IM Server and the Charging Enabler for an IM session establishment originated by an IM Client.

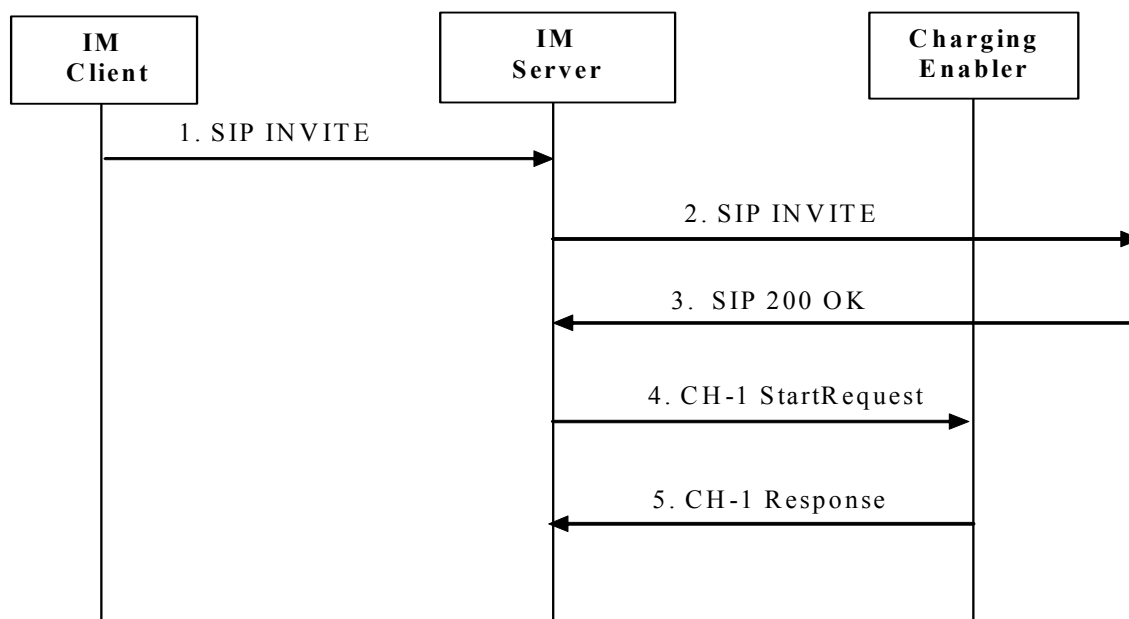

**Figure 9: Offline Charging for one-to-one IM Session Establishment**

NOTE: The forward of the [SIP 200 OK] response to the IM Client has been omitted from figure; however, can be sent at any point after the [SIP 200 OK] is received from the recipient.

1. The IM Server receives a [SIP INVITE] from the IM Client.
2. The IM Server forwards the [SIP INVITE] to the recipient.
3. The IM Server receives a confirmation [SIP 200 OK].
4. The Charging Enabler User in the IM Server receiving a [SIP 200 OK] SHALL trigger a CH-1 StartRequest message towards the Charging Enabler.
5. The Charging Enabler acknowledges with a CH-1 Response message.

### 6.2.3.2 Successful conference IM session Establishment

Below figure shows the charging request transactions between the Charging Enabler User in the IM Server and the Charging Enabler for a conference IM session establishment originated by an IM Client.

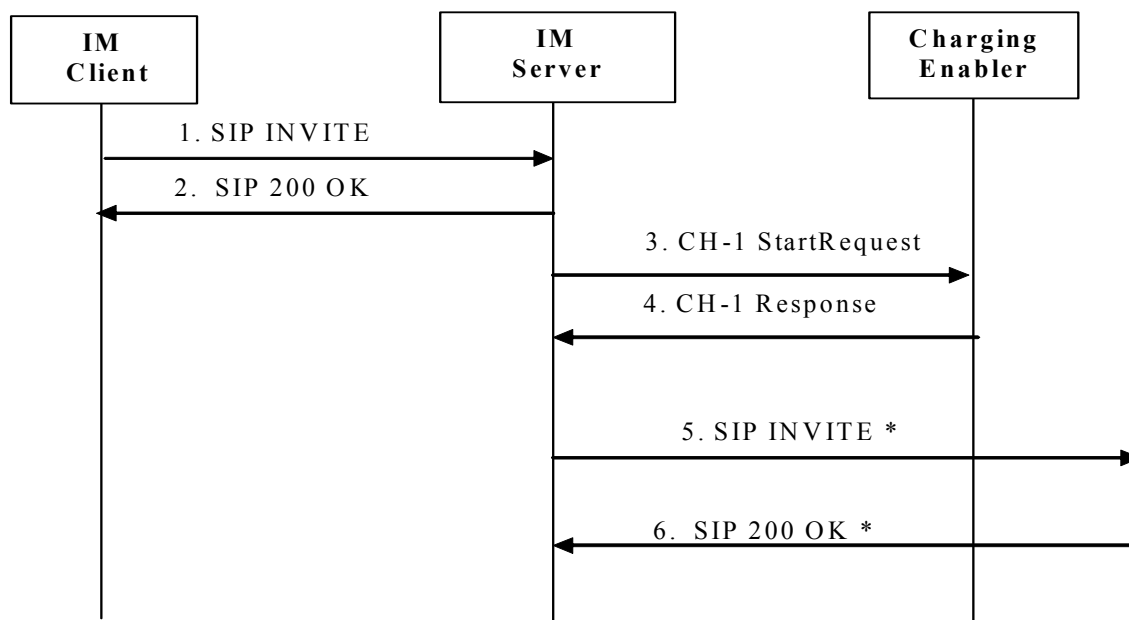
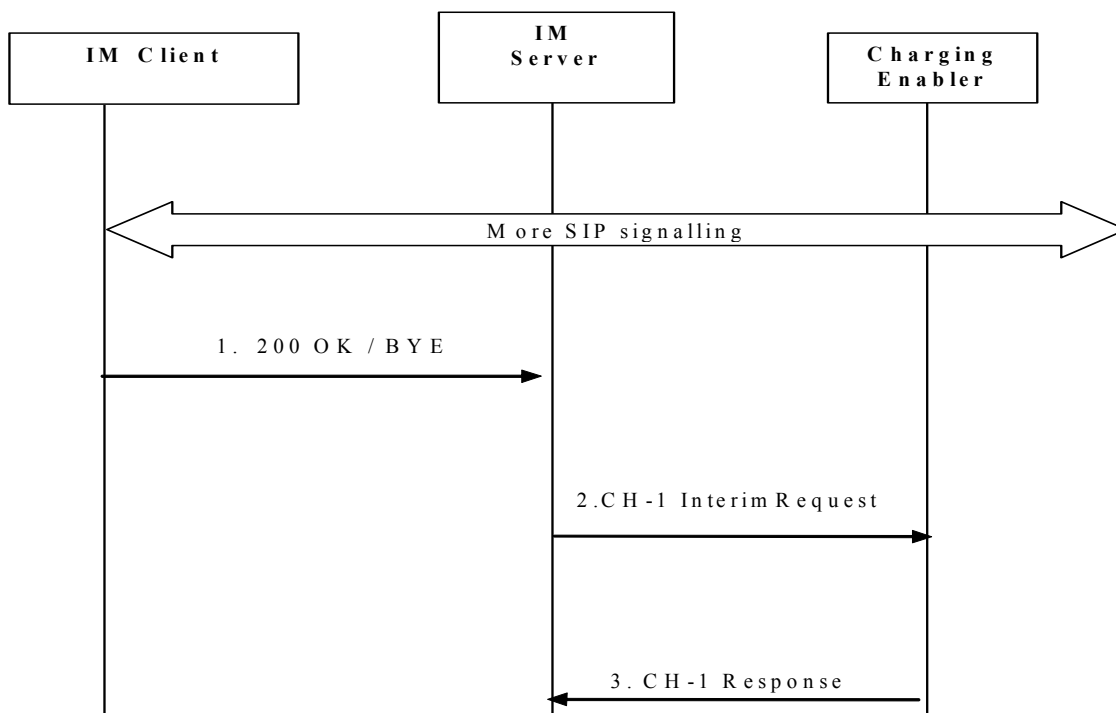

**Figure 10: Offline Charging for conference IM Session Establishment**

1. The IM Server receives a [SIP INVITE] from the IM Client.
2. The IM Server confirms with a [SIP 200 OK] to the recipient.
3. The Charging Enabler User in the IM Server sending a [SIP 200] SHALL trigger a CH-1 StartRequest message towards the Charging Enabler.
4. The Charging Enabler acknowledges with a CH-1 Response message.
5. The IM Server forwards the [SIP INVITE] to the recipients.
6. The IM Server receives confirmation [SIP 200 OK].

### 6.2.3.3 Joining or departure of a conference participant

Figure 11 shows the offline charging request transactions between the Charging Enabler User in the IM Server and the Charging Enabler for joining or departure of a conference participant, i.e when SIP INVITE or BYE requests are received at the IM Server during a session.

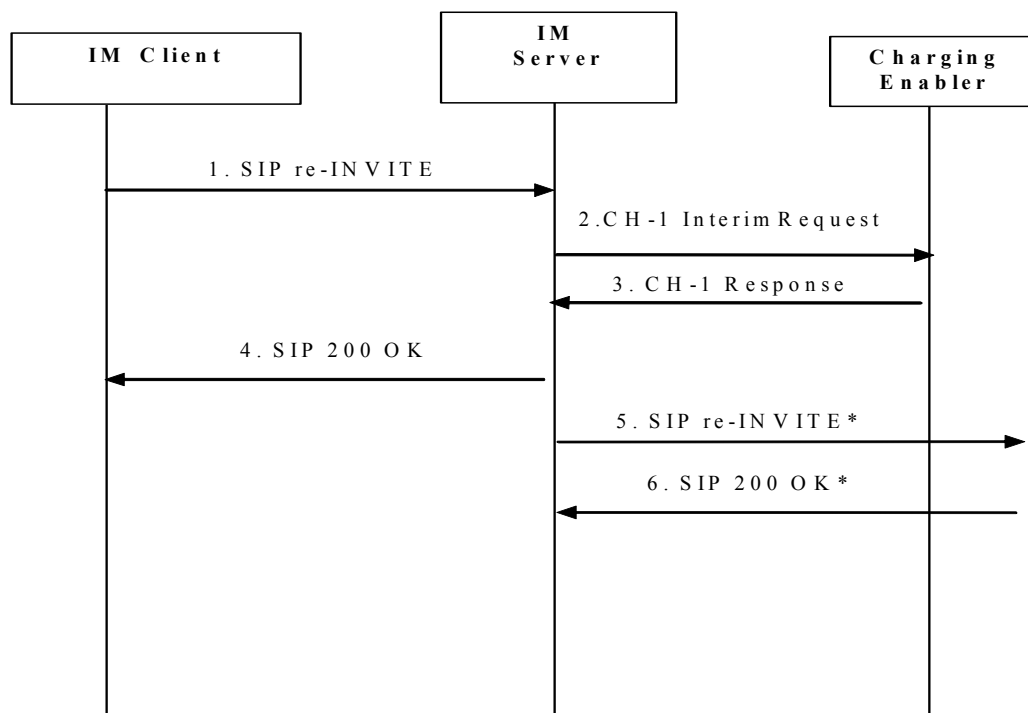

**Figure 11: Offline Charging for Arrival or departure of a conference participant**

1. [SIP 200 OK] (in response to a Server [SIP INVITE] or [SIP BYE]) or [SIP BYE] request is sent to IM Server.
2. The Charging Enabler User in the IM Server receiving a [SIP 200OK] message or a [SIP BYE] message SHALL trigger a CH-1 InterimRequest message towards the Charging Enabler.
3. The Charging Enabler acknowledges with a CH-1 Response message.

#### 6.2.3.4 Session Modification

Figure 12 shows the offline Charging Request transactions between the Charging Enabler User in an IM Server and the Charging Enabler for session modification.



**Figure 12: Offline Charging for session modification**

1. The IM Server receives a [SIP re-INVITE] message from an IM client.
2. The Charging Enabler User in the IM Server receiving a [SIP re-INVITE] SHALL trigger a CH-1 InterimRequest message towards the Charging Enabler.
3. The Charging Enabler acknowledges with a CH-1 Response message.
4. The IM Server confirms IM Client with a [SIP 200 OK].
5. The IM Server forwards the [SIP re-INVITE] message to the recipients.
6. The IM Server receives the corresponding [SIP 200 OK] message from the recipients.

### 6.2.3.5 Message exchange during a chat session

Figure 13 shows the charging request transactions between the Charging Enabler User in the IM Server and the Charging Enabler for message exchange during an IM session.



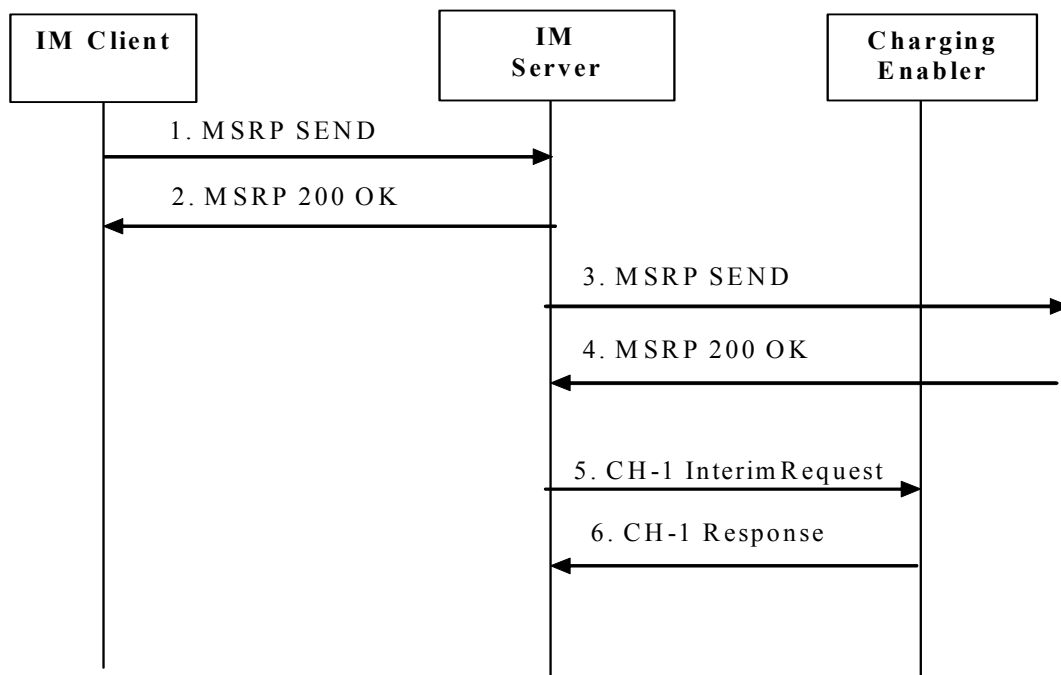

**Figure 13: Offline Charging for IM Session message exchange**

1. The IM Server receives a [MSRP SEND] from the IM Client.
2. The IM Server confirms with a [MSRP 200 OK].
3. The IM Server forwards the [MSRP SEND] to the recipient.
4. The recipient confirms with a [MSRP 200 OK].
5. The Charging Enabler User in the IM Server MAY trigger a CH-1 InterimRequest message towards the Charging Enabler in following cases :
  - a [MSRP 200 OK] or a MSRP error message has been received
  - a timeout for the response message has been reached.
6. The Charging Enabler acknowledges with a CH-1 Response message.

Note that the trigger for sending CH-1 InterimRequest message depends on the interim interval received from the Charging Enabler. However, to prevent the generation of a heavy charging traffic, the trigger configuration should lead to a reasonable InterimRequest message sending frequency.

### 6.2.3.6 IM Session end

The IM Session may be closed either by the IM Client or the IM Server.

Figure 14 shows the charging request transactions between the Charging Enabler User in the IM Server and the Charging Enabler when the IM session is closed at the initiative of the IM Client.

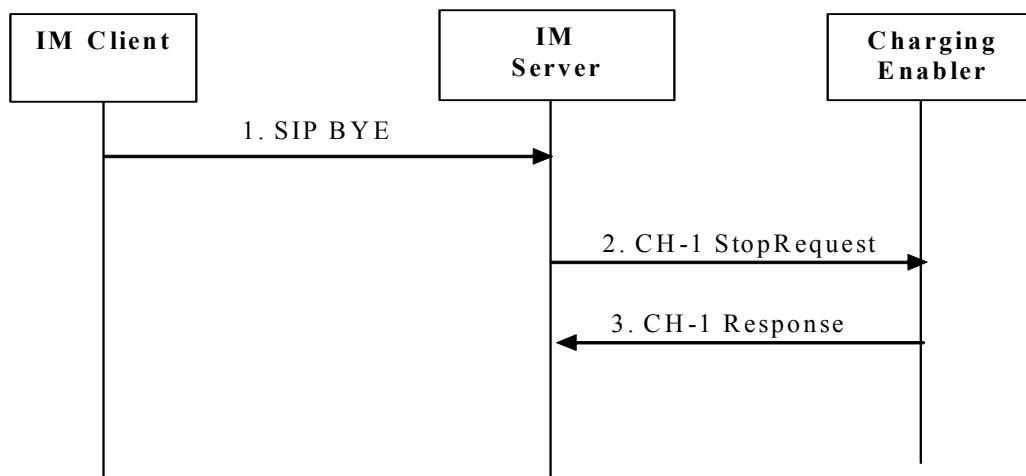
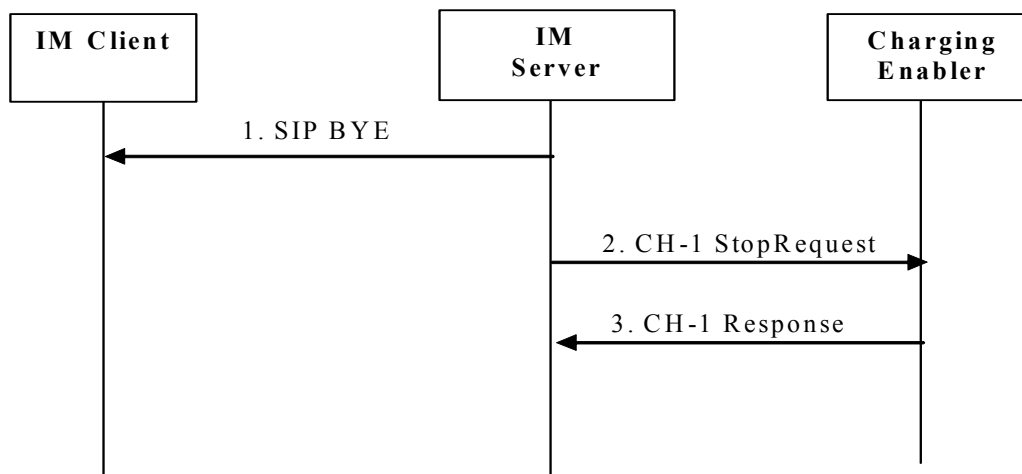

**Figure 14: Offline Charging for IM Session end (client terminating)**

NOTE: The last [SIP 200 OK] response from the IM Server has been omitted from the figure; however, can occur at any point after the [SIP BYE] is received by the IM Server.

1. The IM Client triggers a [SIP BYE] towards the IM Server to terminate the IM Session.
2. The Charging Enabler User in the IM Server receiving a [SIP BYE] message SHALL trigger a CH-1 StopRequest message towards the Charging Enabler.
3. The Charging Enabler acknowledges with a CH-1 Response message.

Figure 15 shows the charging request transactions between the Charging Enabler User in the IM Server and the Charging Enabler when the IM Session is closed at the initiative of the IM Server.



**Figure 15: Offline charging for IM Session end (Server terminating)**

NOTE: The last [SIP 200 OK] response from the IM Client has been omitted from figure; however, can occur at any point after the [SIP BYE] is received by the IM Client.

1. The IM Server sends a [SIP BYE] towards the IM Client to terminate the IM Session.
2. The Charging Enabler User in the IM Server sending a [SIP BYE] message SHALL trigger a CH-1 StopRequest message towards the Charging Enabler.
3. The Charging Enabler acknowledges with a CH-1 Response message.

## 6.3 IM online charging scenarios

### 6.3.1 Basic principles

The charging models as given in chapter 6 SHALL be supported for online charging.

These charging requests SHALL contain distinct service usage data for any of the described sub-services. IM usage data in the charging requests SHALL comprise the duration, volume and number of messages.

OMA SIMPLE IM sessions MAY be charged either using the Event-based messages for online (EventRequest) or the Session-based messages for online (Initial Request, Update Request(s) (zero or more), and Termination Request).

Initial Request and Termination Request message SHALL be generated for the IM session in accordance to the defined triggers for online charging. The generation of UpdateRequests SHALL be governed in accordance to triggers defined for Session-based requests for online requests, or on the values received in the charging responses.

Event-based online charging requests SHALL be generated for pager and Large message mode delivery and MAY be also used for session mode messaging. Session-based charging requests SHALL be generated only for session mode messaging.

In IM session mode, message exchanges within the IM session SHALL be charged using the Session-based Charging with Reservation and may be metered by duration, volume or number of messages. The metering is done by the Charging Enabler User within the IM Server and governed as described by the Charging Enabler [OMA ONLINE CHG].

For events unrelated to a session (e.g. Pager mode message, large mode message, history retrieval), the Charging Enabler User within the IM Server SHALL use Event-based Charging with Unit Reservation.

The Charging Request messages to be sent from a SIMPLE IM Server are described in the following table. Table 2: The Charging Request Messages Triggered by SIP Methods or MSRP Messages for SIMPLE IM Server.

OMA Charging Message	Triggering SIP Method
CH-2 Initial Request	SIP MESSAGE in Page Mode message transmission(ECUR)
	MSRP SEND in Large message transmission(ECUR)
	SIP INVITE in conversation history retrieval(ECUR)
	SIP INVITE in deferred message retrieval(ECUR)
	SIP PUBLISH in deferred message push(ECUR)
	SIP INVITE in successful one-to-one session establishment(SCUR)
	SIP INVITE in successful conference IM session establishment(SCUR)
CH-2 Update Request	MSRP SEND in Message exchange during a chat session(SCUR)
	SIP re-INVITE in Mid IM Session procedure(SCUR)
	SIP BYE acknowledging a party departing from an ongoing adhoc or pre-defined group session
CH-2 Termination Request	SIP 200 OK acknowledging a SIP MESSAGE in Page Mode message transmission(ECUR)
	SIP error message for a SiP MESSAGE in Page Mode message to a single user(ECUR)
	SIP BYE sent from IM Server in Message Exchange during a chat session(SCUR)
	SIP BYE sent from IM Client in Message Exchange during a chat session(SCUR)
	MSRP 200 OK for a MSRP SEND in Large message transmission (ECUR)
	MSRP 200 OK acknowledging MSRP SEND in deferred message retrieval(ECUR)
	MSRP 200 OK for a MSRP SEND in conversation history retrieval(ECUR)
	MSRP 200 OK for aMSRP SEND in deferred message push(ECUR)
	MSRP 200 OK for MSRP SEND in message exchange during a chat session(SCUR)
	MSRP error message for a MSRP SEND in Large message transmission(ECUR)
	MSRP error message for a MSRP SEND in conversation history retrieval(ECUR)
	MSRP error message for a MSRP SEND in deferred message retrieval(ECUR)
	MSRP error message for a MSRP SEND in deferred message push(ECUR)
CH-2 Balance Check Request	SIP INVITE in Large message transmission (Balance Check)

**Table 2: The Charging Request Messages Triggered by SIP Methods or MSRP Messages for SIMPLE IM Server**

## 6.3.2 Online Charging for IM Events

### 6.3.2.1 Pager mode message to a single user

Figure 16 shows the online Charging Request transactions between the Charging Enabler User in the IM Server and the Charging Enabler for the Pager mode message delivery.

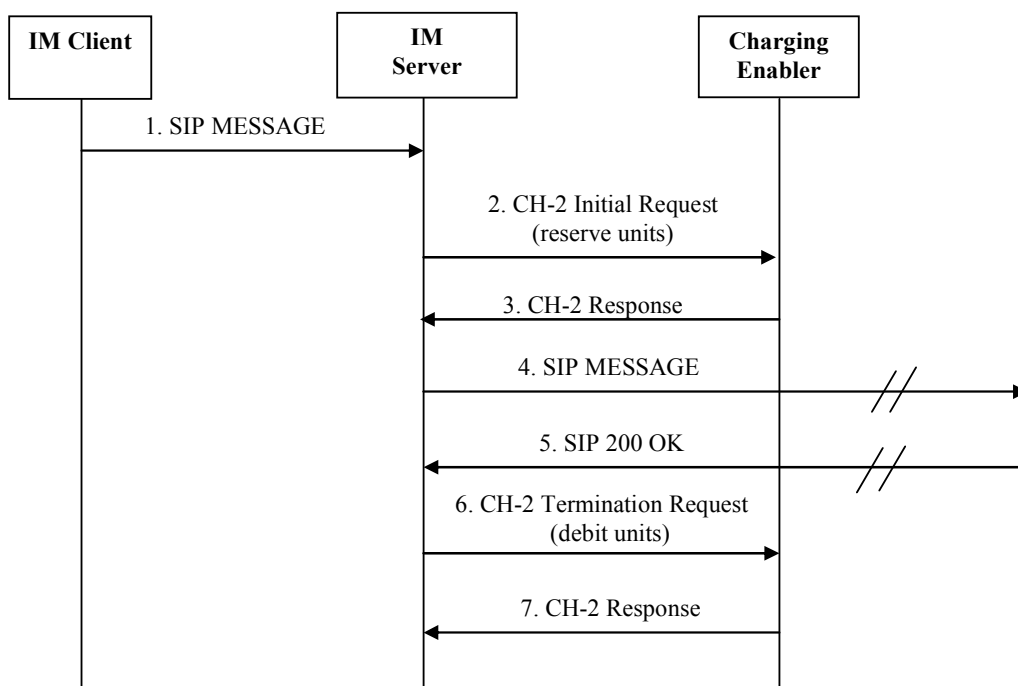

**Figure 16: Online Charging for Pager Mode Messages to a Single User**

NOTE: The [SIP 200 OK] response to the IM Client has been omitted from figure; however can occur at any point after the [SIP 200 OK] is received from the user agent of the recipient.

1. The IM Server receives a [SIP MESSAGE] from the IM Client.
2. The Charging Enabler User in the IM Server receiving a [SIP MESSAGE] message SHALL trigger a CH-2 Initial Request (reserve units) message towards the Charging Enabler for credit reservation.
3. The Charging Enabler acknowledges with a CH-2 Response message including the result of the credit reservation.
4. The IM Server forwards the [SIP MESSAGE] to the recipient.
5. The IM Server receives a [SIP 200 OK] confirmation.
6. The Charging Enabler User in the IM Server SHALL trigger a CH-2 Termination Request (debit units) message towards the Charging Enabler for used units to be debited in the following cases:
  - a [SIP 200 OK] or a SIP error message has been received
  - a timeout for the response message has been reached.
7. The Charging Enabler acknowledges with a CH-2 Response including the result of the debit operation.

### 6.3.2.2 Pager mode message to an ad hoc or predefined group

Figure 17 shows the online Charging Request transactions between the Charging Enabler User in the IM Server and the Charging Enabler for the Pager mode message delivery to an ad hoc or predefined group. Each Pager mode group message shall be treated independently.

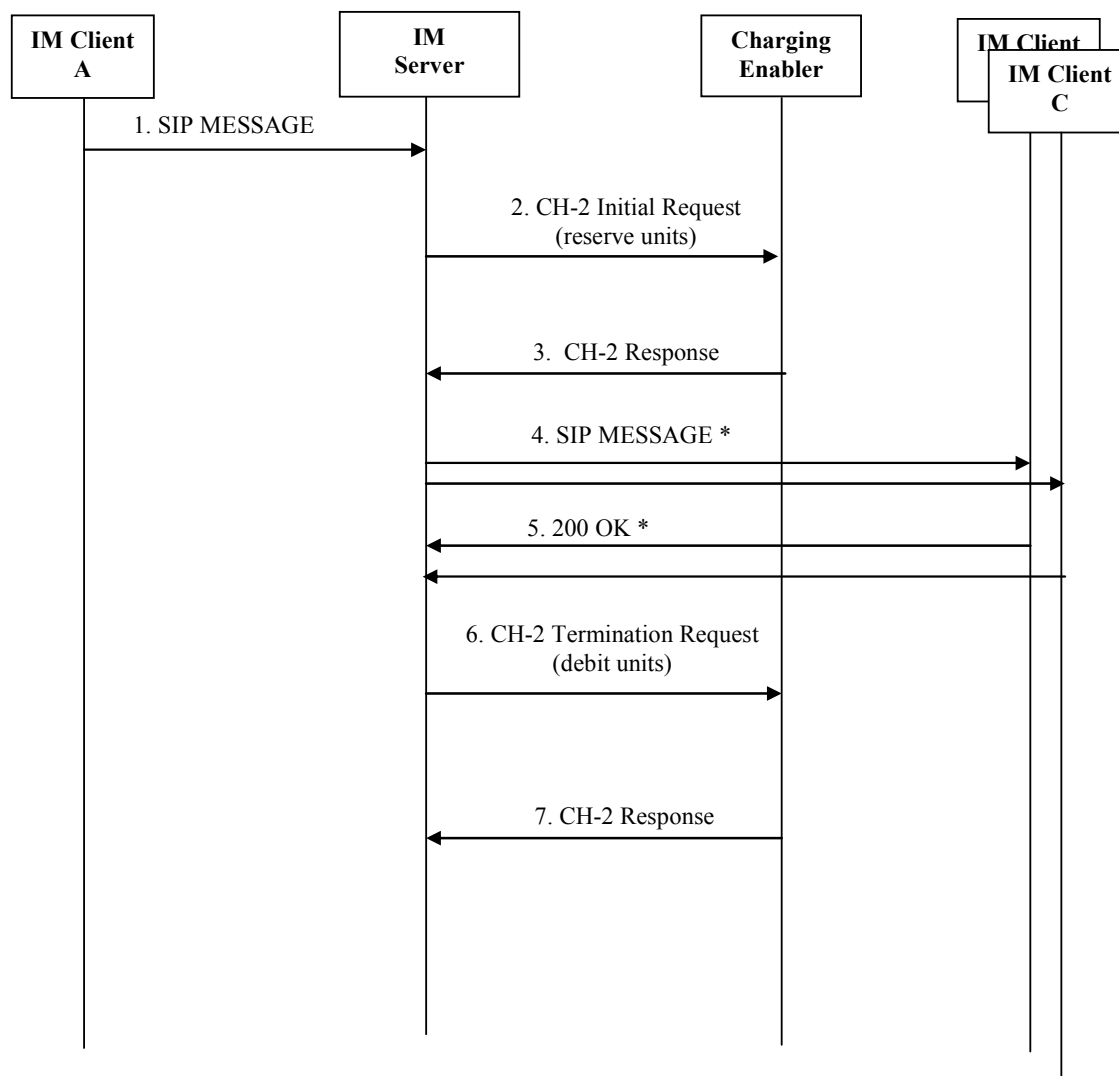

**Figure 17: Online Charging for Pager Mode Message to an ad hoc or predefined group**

NOTE: The [SIP 200 OK] response to the IM Client A has been omitted from figure; however can occur at any point after all the [SIP 200 OK] are received from IM Client B and C.

1. The IM Server receives a [SIP MESSAGE] from the IM Client.
2. The Charging Enabler User in the IM Server receiving a [SIP MESSAGE] message SHALL trigger a CH-2 Initial Request (reserve units) message towards the Charging Enabler for credit reservation.
3. The Charging Enabler acknowledges with a CH-2 Response message including the result of the credit reservation.
4. The IM Server forwards the [SIP MESSAGE]s to the recipients.

5. The IM Server receives corresponding [SIP 200OK]s or SIP error messages.
6. The Charging Enabler User in the IM Server SHALL trigger a CH-2 Termination Request (debit units) message towards the Charging Enabler for used units to be debited. The message SHALL be triggered when all responses have been received ([SIP 200 OK] or SIP error message) or a timeout for responses has been reached. Note that the 'reserve units' validity timer SHALL be greater than the IM delivery notifications timer (Ts2) as defined in [IM-TS].
7. The Charging Enabler acknowledges with a CH-2 Response including the result of the debit operation.

### 6.3.2.3 Large message

Figure 18 shows the online Charging Request transactions between the Charging Enabler User in the IM Server and the Charging Enabler for the Large message delivery. Each Large message shall be treated independently.

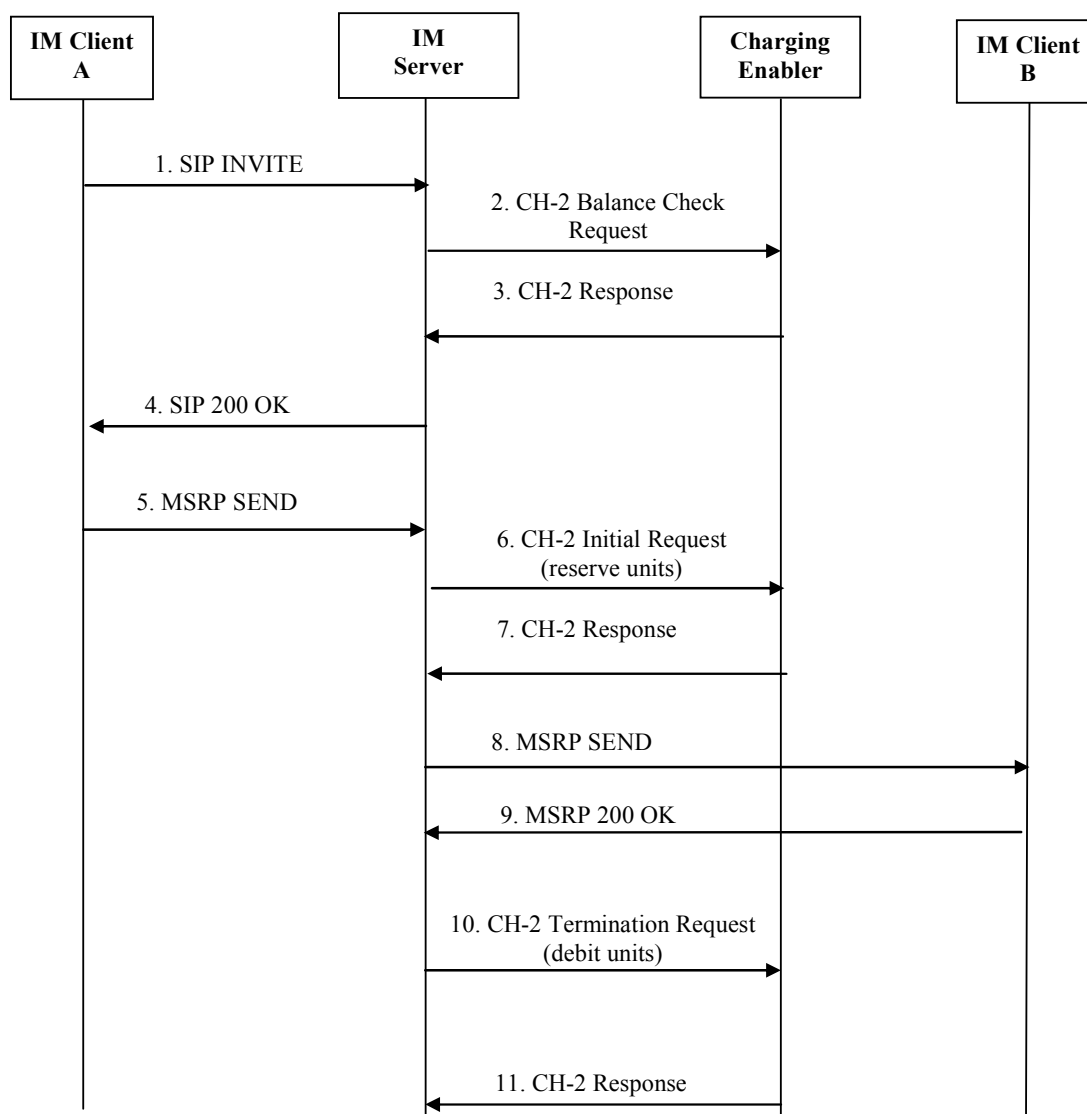

**Figure 18: Online Charging for Large message**

NOTE: The [MSRP 200 OK] response to the IM Client A has been omitted from figure; however can occur at any point after the [MSRP 200 OK] is received from IM Client B.



1. The IM Server receives a [SIP INVITE] from the IM Client.
2. The Charging Enabler User in the IM Server receiving a [SIP INVITE] message MAY trigger a CH-2 BalanceCheck Request message towards the Charging Enabler to ensure the IM Client has the minimum credit for sending a Large message.
3. The Charging Enabler acknowledges with a CH-2 Response message including the result of the balance check.
4. The IM Server confirms with a [SIP 200 OK].
5. The IM Server receives a [MSRP SEND] from the IM Client.
6. The Charging Enabler User in the IM Server receiving a [MSRP SEND] message SHALL trigger a CH-2 Initial Request (reserve units) message towards the Charging Enabler for credit reservation. The amount of credit reserved MAY be based on message size described in [MSRP SEND].
7. The Charging Enabler acknowledges with a CH-2 Response message including the result of the credit reservation.
8. The IM Server forwards the [MSRP SEND] to the recipient.
9. The IM Server receives the corresponding [MSRP 200 OK].
10. The Charging Enabler User in the IM Server SHALL trigger a CH-2 Termination Request (debit units) message towards the Charging Enabler for used units to be debited. The charging message SHALL be triggered when one of the following has occurred: - [MSRP 200 OK] response indicating the receipt of the complete message by a recipient (i.e. all chunks within the MSRP )
  - an MSRP error message is received
  - timeout has been reached.

NOTE: The IM Server MAY receive multiple [MSRP 200 OK] messages (e.g. when a large message has been broken down in to smaller chunks); however, these [MSRP 200 OK] messages SHALL NOT trigger a charging request message. In this case, the IM Server SHALL trigger a CH-2 Termination Request message only after receiving the last [MSRP 200 OK] and determining that the transmission of the chunked messages is completed.

11. The Charging Enabler acknowledges with a CH-2 Response including the result of the debit operation.

### 6.3.2.4 Large message to a predefined or ad hoc group

Figure 19 shows the online Charging Request transactions between the Charging Enabler User in the IM Server and the Charging Enabler for the Large message delivery to a predefined or ad hoc group. Each Large mode group message shall be treated independently.

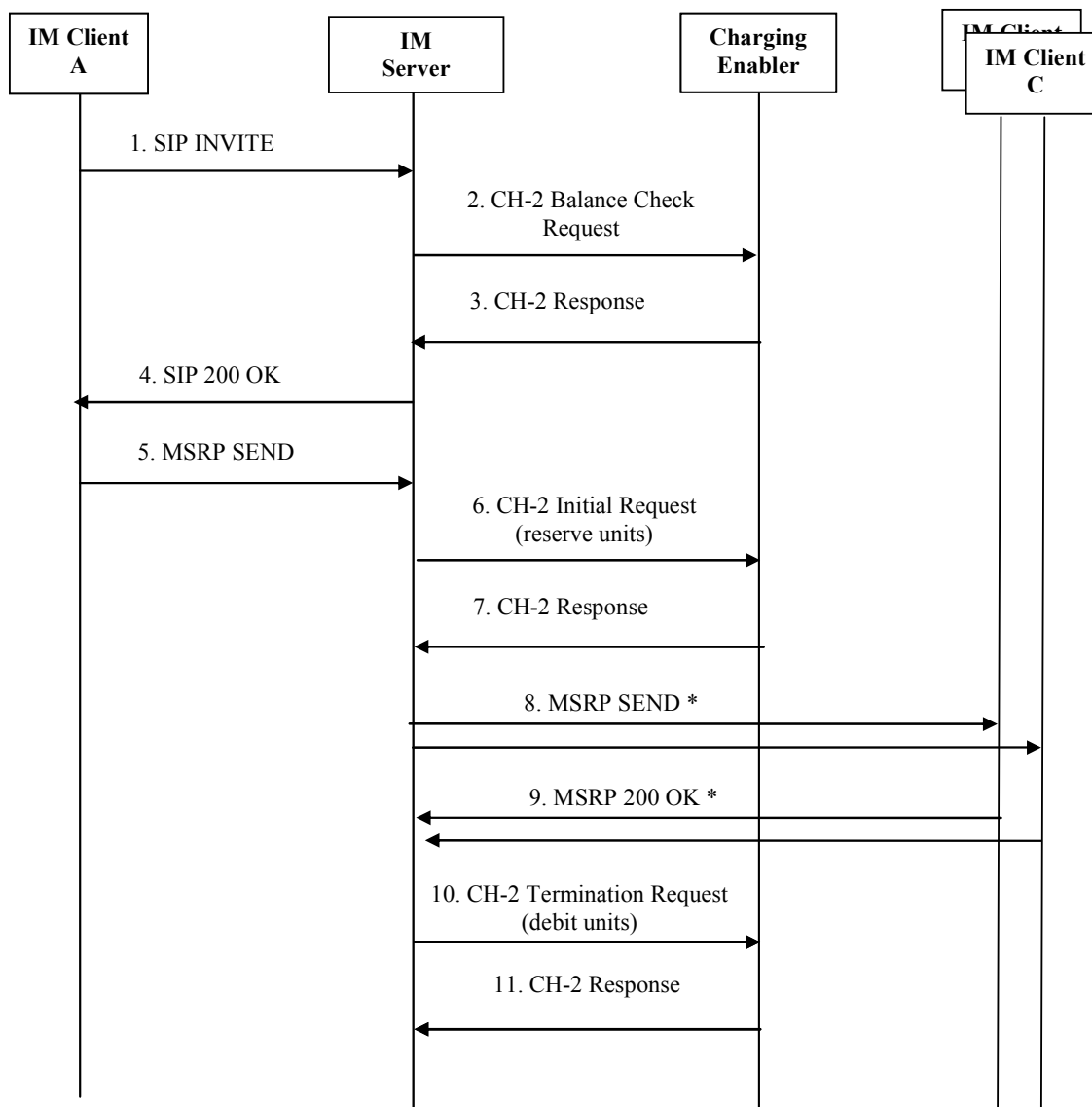

**Figure 19: Online Charging for Large message to an ad hoc or predefined group**

NOTE: The [MSRP 200 OK] response to the IM Client A has been omitted from figure; however can occur at any point after the [MSRP 200 OK] is received from IM Client B or C.

1. The IM Server receives a [SIP INVITE] from the IM Client.
2. The Charging Enabler User in the IM Server receiving a [SIP INVITE] message MAY trigger a CH-2 BalanceCheck Request message towards the Charging Enabler to ensure the IM Client has the minimum credit for sending a Large message.

3. The Charging Enabler acknowledges with a CH-2 Response message including the result of the credit balance check.
4. The IM Server confirms with a [SIP 200 OK].
5. The IM Server receives a [MSRP SEND] from the IM Client.
6. The Charging Enabler User in the IM Server receiving a [SIP INVITE] message SHALL trigger a CH-2 Initial Request (reserve units) message towards the Charging Enabler for credit reservation. The amount of credit reserved will be based on the message size described in the [MSRP SEND].
7. The Charging Enabler acknowledges with a CH-2 Response message including the result of the credit reservation.
8. The IM Server forwards the [MSRP SEND] to the recipients.
9. The IM Server receives the corresponding [MSRP 200 OK](s).
10. The Charging Enabler User in the IM Server SHALL trigger a CH-2 Termination Request (debit units) message towards the Charging Enabler for used units to be debited when, for each message, a all [MSRP 200 OK] message or a MSRP error response messages have been received or the timeout for response has been reached.
11. The Charging Enabler acknowledges with a CH-2 Response including the result of the debit operation.

### 6.3.2.5 Conversation History Retrieval

Figure 20 shows the online Charging Request transactions between the Charging Enabler User in the IM Server and the Charging Enabler for the History retrieval. Each history retrieval request shall be treated independently.

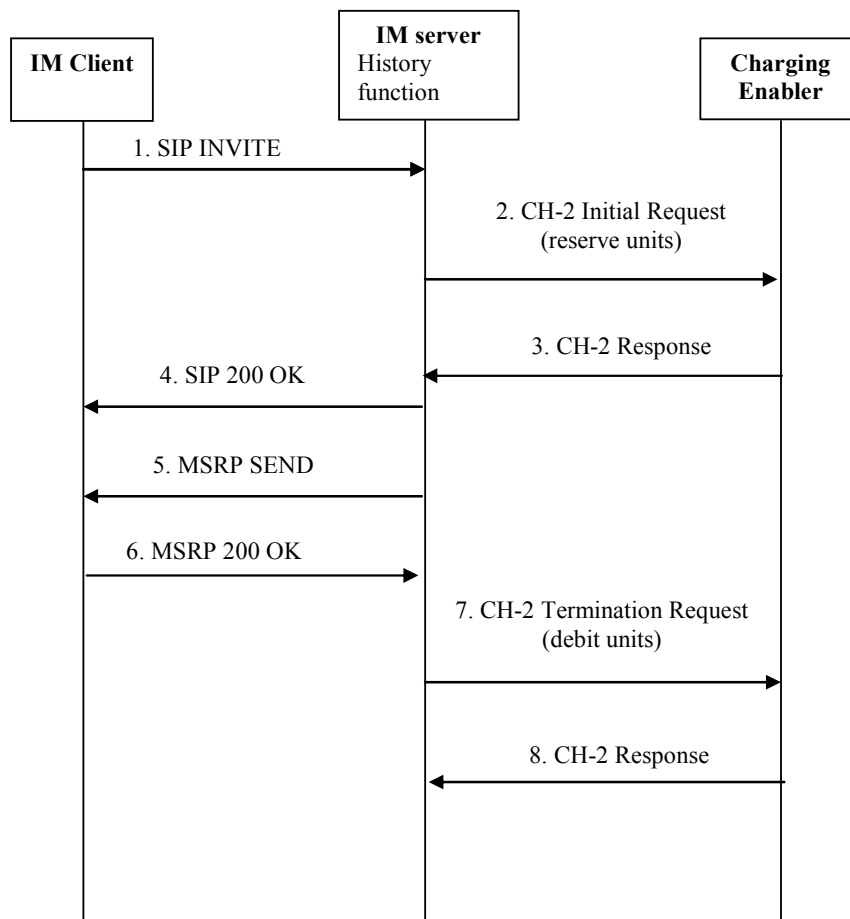

**Figure 20: Online charging for Conversation History retrieval**

NOTE: The [SIP BYE] from the IM Client has been omitted from figure; however can occur at any point after the [MSRP 200 OK] is sent by the IM Client.

1. The IM Server receives a [SIP INVITE] from IM Client.
2. The Charging Enabler User in the IM Server receiving a [SIP INVITE] message SHALL trigger a CH-2 Initial Request (reserve units) message towards the Charging Enabler for credit reservation.
3. The Charging Enabler acknowledges with a CH-2 Response message including the result of the credit reservation.
4. The IM Server confirms with a [SIP 200 OK].
5. The IM Server sends [MSRP SEND] to IM Client including the conversation history.
6. The IM Server receives a [MSRP 200 OK] from IM Client.
7. The Charging Enabler User in the IM Server SHALL trigger a CH-2 Termination Request (debit units) message towards the Charging Enabler for used units to be debited in the following cases:

- a [MSRP 200 OK] or a MSRP error message has been received
- a timeout for the response message has been reached.

8. The Charging Enabler acknowledges with a CH-2 Response including the result of the debit operation.

### 6.3.2.6 Deferred Message Retrieval

Figure 21 shows the online Charging Request transactions between the Charging Enabler User in the IM Server and the Charging Enabler for the History retrieval. Each history retrieval request shall be treated independently.

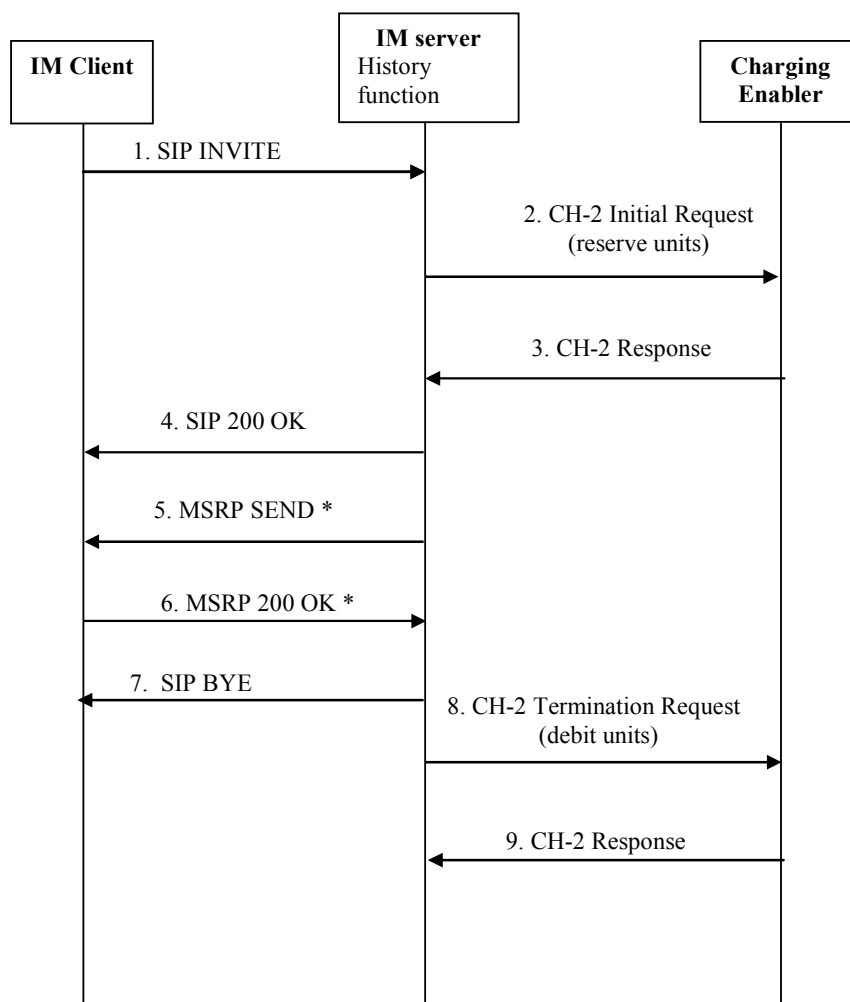

**Figure 21: Online charging for retrieving deferred messages**

NOTE: The last [SIP 200 OK] from the IM Client has been omitted from the figure; however it can occur at any point after the [SIP BYE] is received from IM Server.

1. The IM Server receives a [SIP INVITE] from IM Client.
2. The Charging Enabler User in the IM Server receiving a [SIP INVITE] message SHALL trigger a CH-2 Initial Request (reserve units) message towards the Charging Enabler for credit reservation.

3. The Charging Enabler acknowledges with a CH-2 Response message including the result of the credit reservation.
4. The IM Server confirms with a [SIP 200 OK].
5. The IM Server sends one or more [MSRP SEND] containing the deferred messages to the IM Client.
6. The IM Client responds with one or more [MSRP 200 OK].
7. The IM Server sends a [SIP BYE] to the IM Client.
8. The Charging Enabler User in the IM Server SHALL trigger a CH-2 Termination Request (debit units) message towards the Charging Enabler for used units to be debited in the following cases:
  - a [MSRP 200 OK] or an MSRP error message has been received
  - a timeout for the response message has been reached.
9. The Charging Enabler acknowledges with a CH-2 Response including the result of the debit operation.

### 6.3.2.7 Deferred Message Push

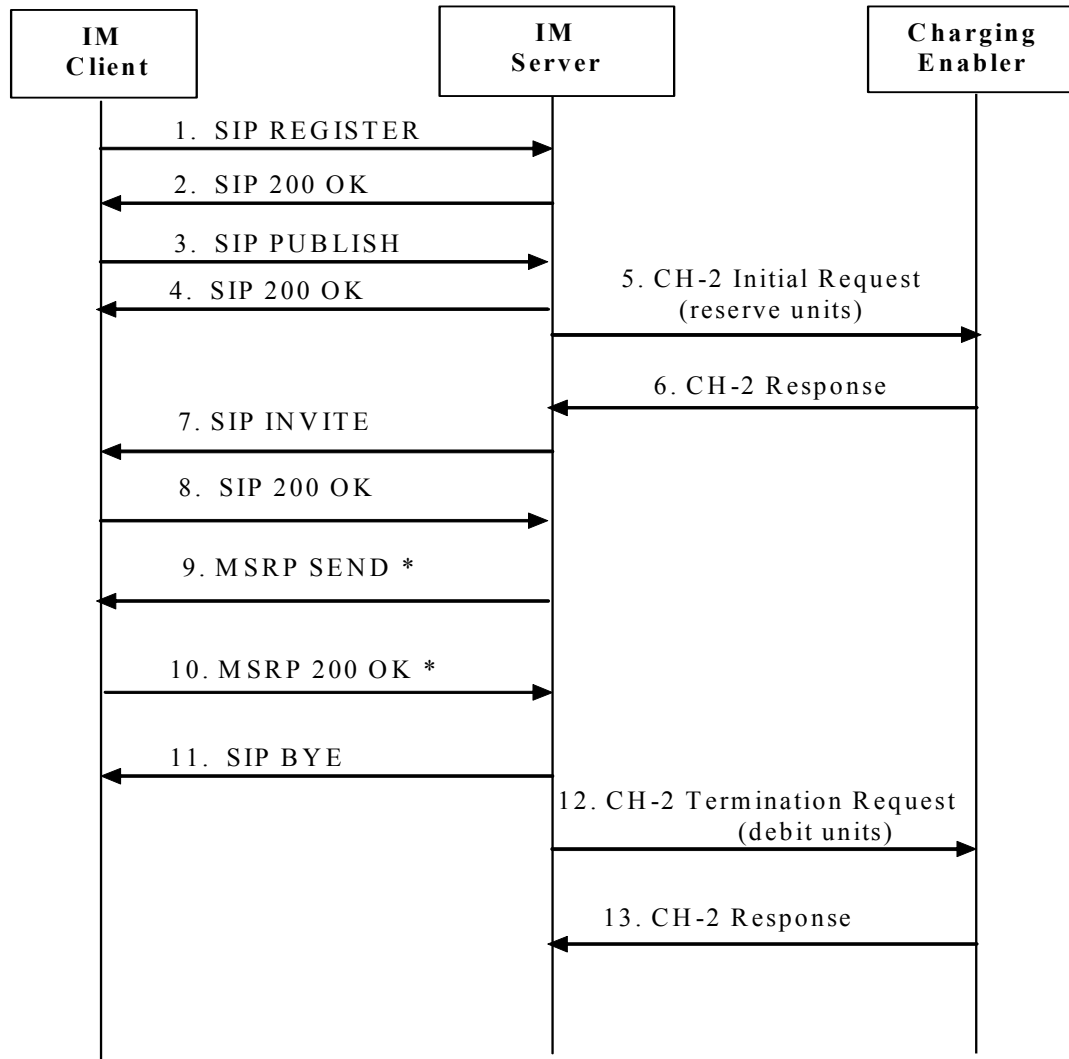

Figure 22: online charging for pushing deferred messages

NOTE: The last [SIP 200 OK] response from the IM Client has been omitted from figure; however can occur at any point after the [SIP BYE] is sent to the IM Client.

1. The IM Server receives a [SIP REGISTER] from the IM Client, this third-party register is optional but very common.
2. The IM Server acknowledges with a [SIP 200 OK].
3. THE IM Server receives a [SIP PUBLISH] of IM Service settings from the IM Client.
4. The IM Server acknowledges with a [SIP 200 OK].
5. The Charging Enabler User receiving [SIP PUBLISH] message SHALL trigger a CH-2 Initial Request (reserve units) message towards the Charging Enabler for credit reservation.
6. The Charging Enabler acknowledges with a CH-2 Response message including the result of the credit reservation.
7. The IM Server sends a [SIP INVITE] to the IM Client.
8. The IM Server receives a confirmation [SIP 200 OK] from the IM Client.
9. The IM Server sends one or more [MSRP SEND] containing the deferred message(s).
10. The IM Server receives one or more [MSRP 200 OK] from the IMClient.
11. The IM Server sends a [SIP BYE] to the IM Client.
12. The Charging Enabler User in the IM Server SHALL trigger a CH-2 Termination Request (debit units) message towards the Charging Enabler for used units to be debited in the following cases:
  - all responses have been received ([MSRP 200 OK] or MSRP error message)
  - a timeout for the response message has been reached.
13. The Charging Enabler acknowledges with a CH-2 Response including the result of the debit operation.

## 6.3.3 Online Charging for IM sessions

### 6.3.3.1 Successful one-to-one IM session Establishment

Figure 23 shows the Charging Request transactions between the Charging Enabler User in the IM Server and the Charging Enabler for IM session establishment originated by an IM Client.

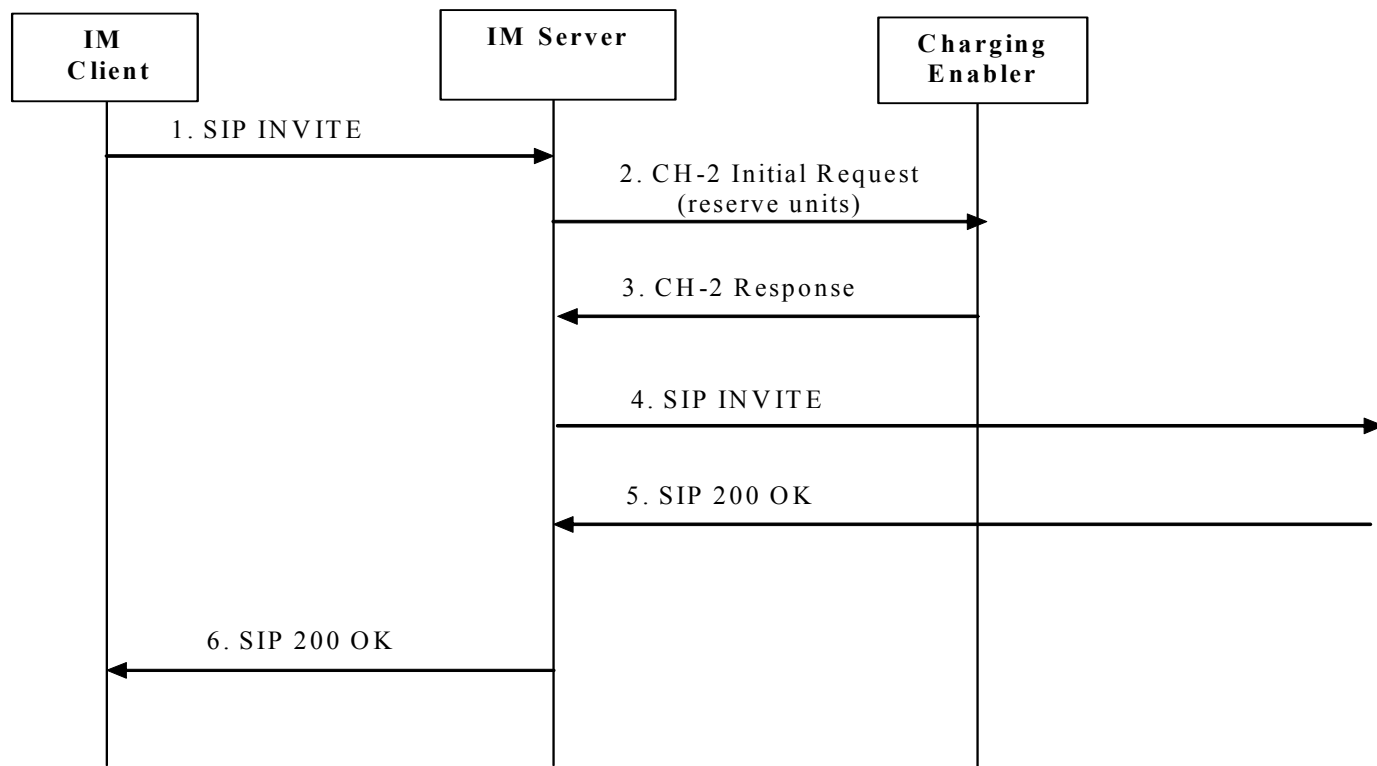

**Figure 23: Online Charging for IM Session Establishment**

1. The IM Server receives a [SIP INVITE] from the IM Client.
2. The Charging Enabler User in the IM Server receiving a [SIP 200 OK] SHALL trigger a CH-2 Initial Request (reserve units) message towards the Charging Enabler to reserve the units and start the charging session.
3. The Charging Enabler acknowledges with a CH-2 Response message including the result of the credit reservation.
4. The IM Server forwards the [SIP INVITE] to the recipient.
5. The IM Server receives a confirmation [SIP 200 OK].
6. The IM Server forwards the [SIP 200 Ok] to the IM Client.



### 6.3.3.2 Successful conference IM session Establishment

Figure 24 shows the Charging Request transactions between the Charging Enabler User in the IM Server and the Charging Enabler for IM session establishment originated by an IM Client.

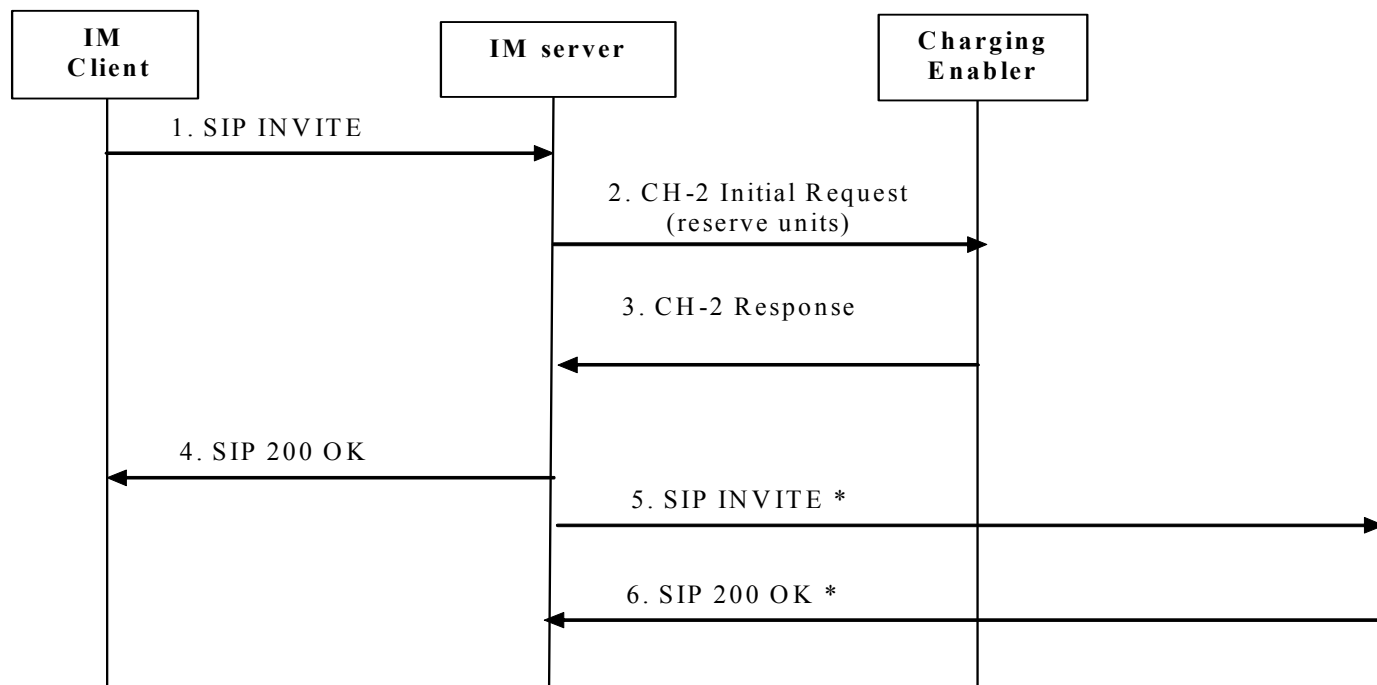
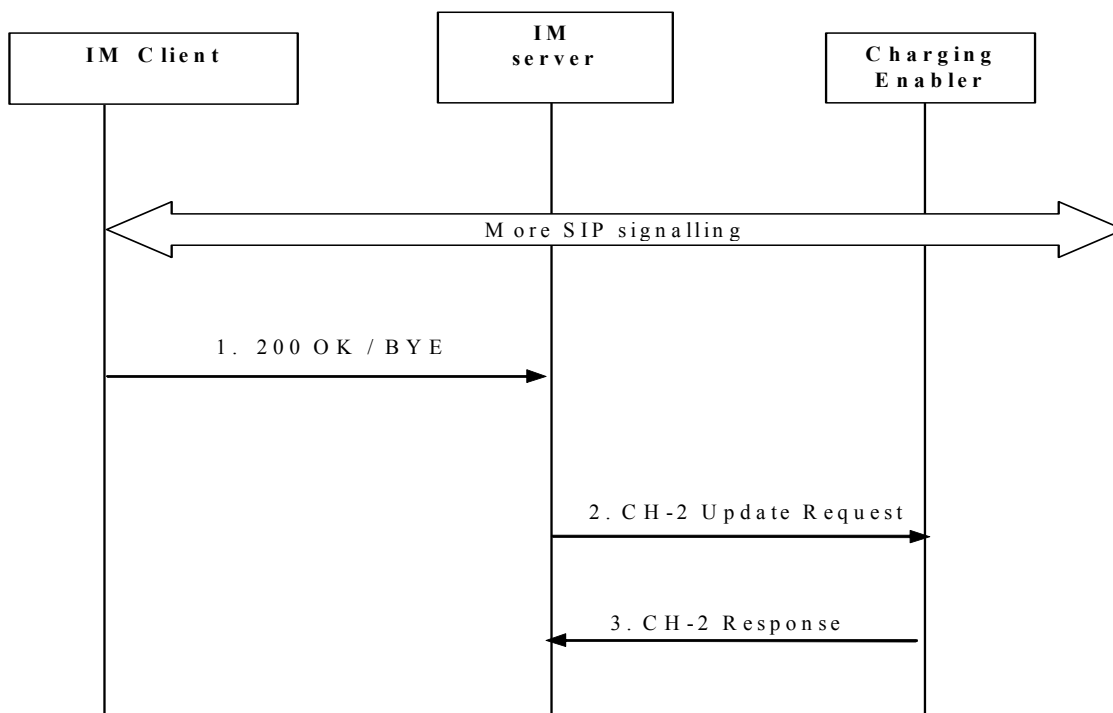

**Figure 24: Online Charging for Conference IM Session Establishment**

1. The IM Server receives a [SIP INVITE] from the IM Client.
2. The Charging Enabler User in the IM Server receiving a [SIP INVITE] SHALL trigger a CH-2 Initial Request (reserve units) message towards the Charging Enabler to reserve the units and start the charging session.
3. The Charging Enabler acknowledges with a CH-2 Response message including the result of the credit reservation.
4. The IM Server acknowledges the [SIP INVITE] with a [SIP 200 OK] to the IM Client.
5. The IM Server forwards the [SIP INVITE] to the recipients.
6. The IM Server receives confirmation [SIP 200 OK].

### 6.3.3.3 Joining or departure of a conference participant

Figure 25 shows the online charging request transactions between the Charging Enabler User in the IM Server and the Charging Enabler for the joining or departure of a conference participant.

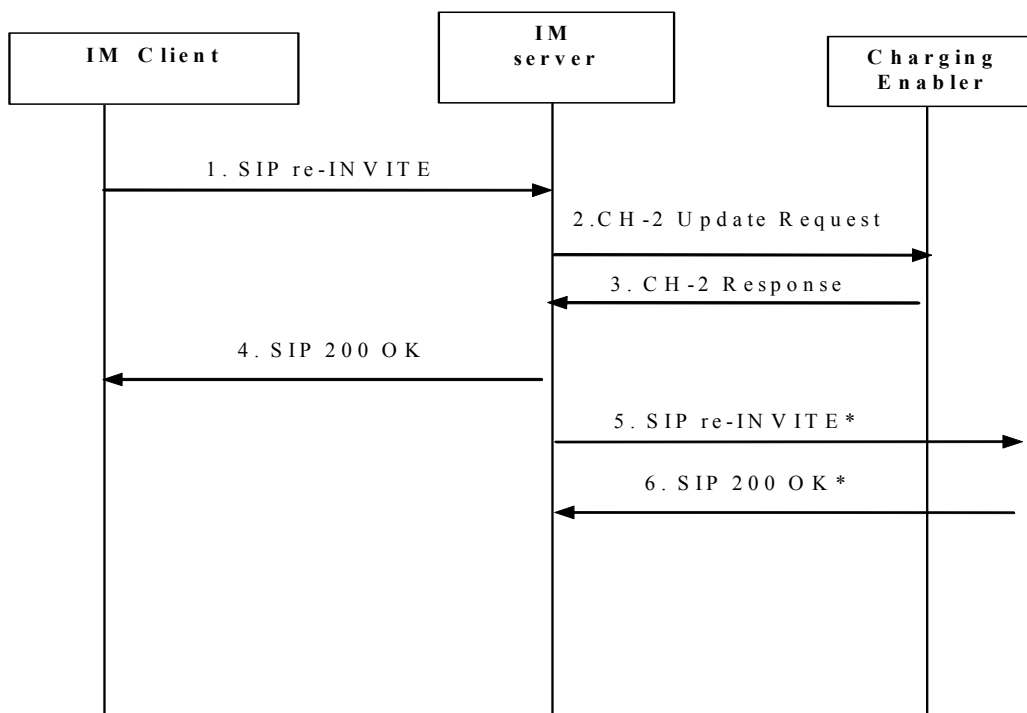

**Figure 25: Online Charging for joining or departure of a conference participant**

1. SIP 200 OK (in response to a Server SIP INVITE or SIP BYE) or BYE request are sent to the IM Server.
2. The Charging Enabler User in the IM Server receiving a [SIP 200OK] message or a [SIP BYE] message SHALL trigger a CH-2 Update Request message towards the Charging Enabler to debit the used units and reserve new units.
3. The Charging Enabler acknowledges with a CH-2 Response message.

#### 6.3.3.4 Session modification

Figure 26 shows the online Charging Request transactions between the Charging Enabler User in the IM Server and the Charging Enabler for session modification.

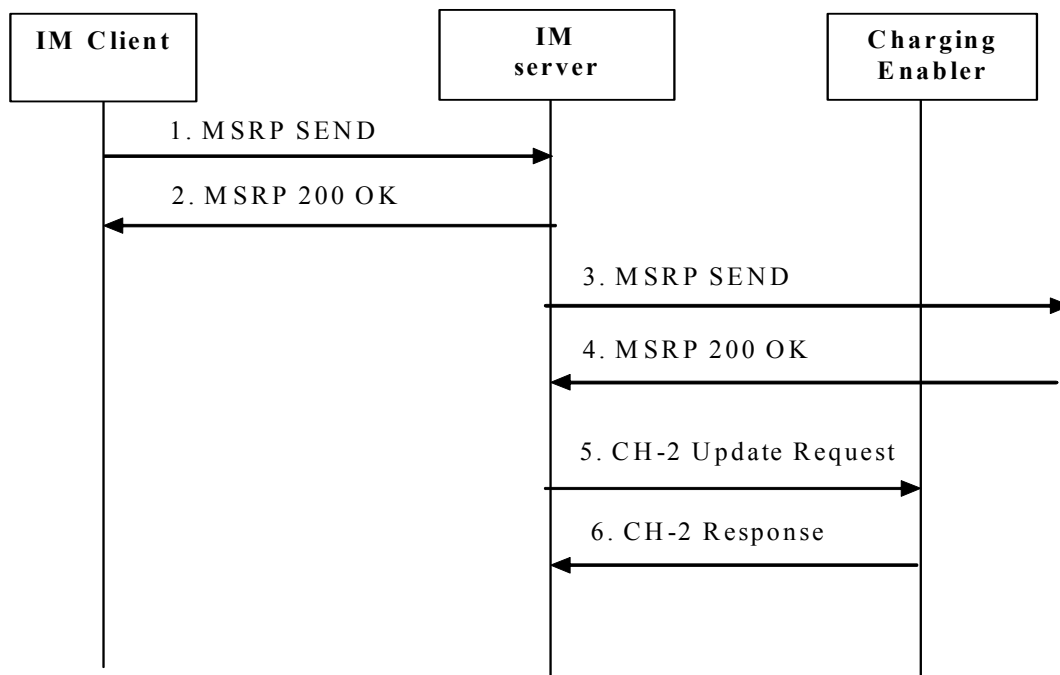

**Figure 26: Online Charging for session modification**

1. The IM Server receives a [SIP re-INVITE] from IM client.
2. The Charging Enabler User in the IM Server receiving a [SIP re-INVITE] SHALL trigger a CH-2 Update Request message towards the Charging Enabler to debit the used units and reserve new units.
3. The Charging Enabler acknowledges with a CH-2 Response.
4. The IM Server confirms with a [SIP 200 OK].
5. The IM Server forwards the [SIP re-INVITE] to the recipients.
6. The IM Server receives the corresponding [SIP 200 OK] from the recipients.

### 6.3.3.5 Message exchange during a chat session

Figure 27 shows the online Charging Request transactions between the Charging Enabler User in the IM Server and the Charging Enabler for message exchange during an IM session.



**Figure 27: Online Charging for message exchange during IM session**

1. The IM Server receives a [MSRP SEND] from the IM Client.
2. The IM Server acknowledges with a [MSRP 200 OK].
3. The IM Server forwards the [MSRP SEND] to the recipient.
4. The recipient confirms with a [MSRP 200 OK].
5. The Charging Enabler User in the IM Server MAY trigger a CH-2 Update Request message towards the Charging Enabler to debit the used units and reserve new units in the following cases :
  - a [MSRP 200 OK] or a MSRP error message has been received
  - a timeout for the response message has been reached.
6. The Charging Enabler acknowledges with a CH-2 Response including the result of the debit operation.

Note that the trigger for sending CH-2 Update Request message depends on the interim interval received from the Charging Enabler. However, to prevent the generation of a heavy charging traffic, the trigger configuration should lead to a reasonable sending frequency.

### 6.3.3.6 IM Session end

The closing of a session can either be at the initiative of the IM Server or the IM Client.

Figure 28 shows the online charging request transactions between the Charging Enabler User in the IM Server and the Charging Enabler when the IM session is closed at the initiative of the IM Client.

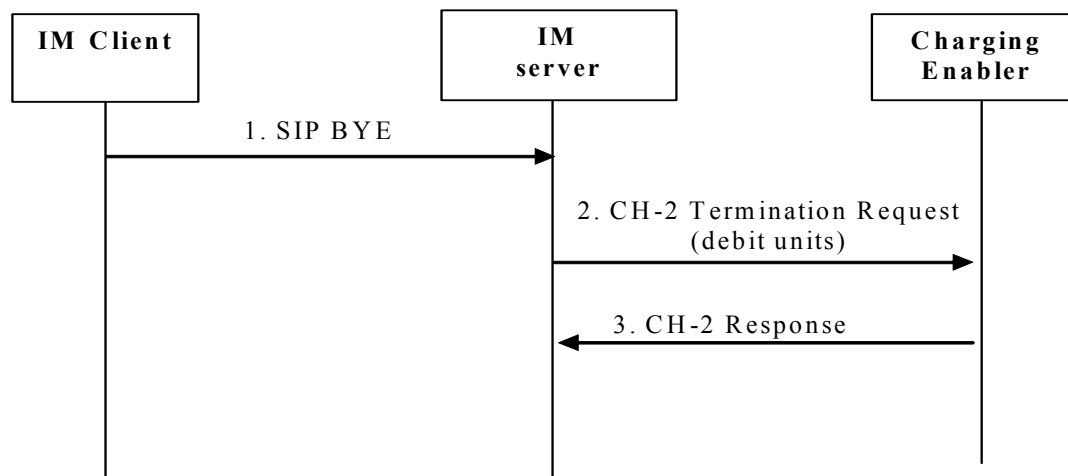
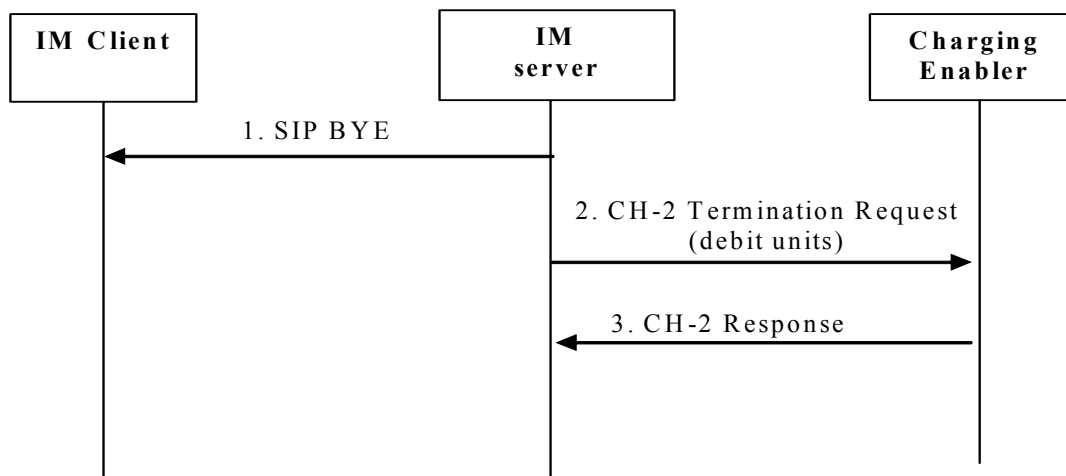

**Figure 28: Online Charging for IM Session end (client terminating)**

NOTE: The last [SIP 200 OK] response from the IM Server has been omitted from figure; however can occur at any point after the [SIP BYE] is received by the IM Server.

1. The IM Server receives a [SIP BYE] from the IM Client.
2. The Charging Enabler User in the IM Server receiving the [SIP BYE] message SHALL trigger a CH-2 Termination Request (debit units) message towards the Charging Enabler to debit the used units and close the charging session.
3. The Charging Enabler acknowledges with a CH-2 Response including the result of the debit operation.

Figure 29 shows the online charging request transactions between the Charging Enabler User in the IM Server and the Charging Enabler when the IM session is closed at the initiative of the IM Server.



**Figure 29: Online Charging for IM Session end (Server terminating)**

NOTE: The last [SIP 200 OK] response from the IM Client has been omitted from figure; however can occur at any point after the [SIP BYE] is received by the IM Client.

1. The IM Server sends a [SIP BYE] to the IM Client.
2. The Charging Enabler User in the IM Server sending the [SIP BYE] message SHALL trigger a CH-2 Termination Request (debit units) message towards the Charging Enabler to debit the used units and close the charging session.
3. The Charging Enabler acknowledges with a CH-2 Response including the result of the debit operation.

### 6.3.3.7 Participant number based online charging for session owner

Figure 30 shows the charging request transactions between IM Server and Charging Enabler in Participant number based charging for session owner.

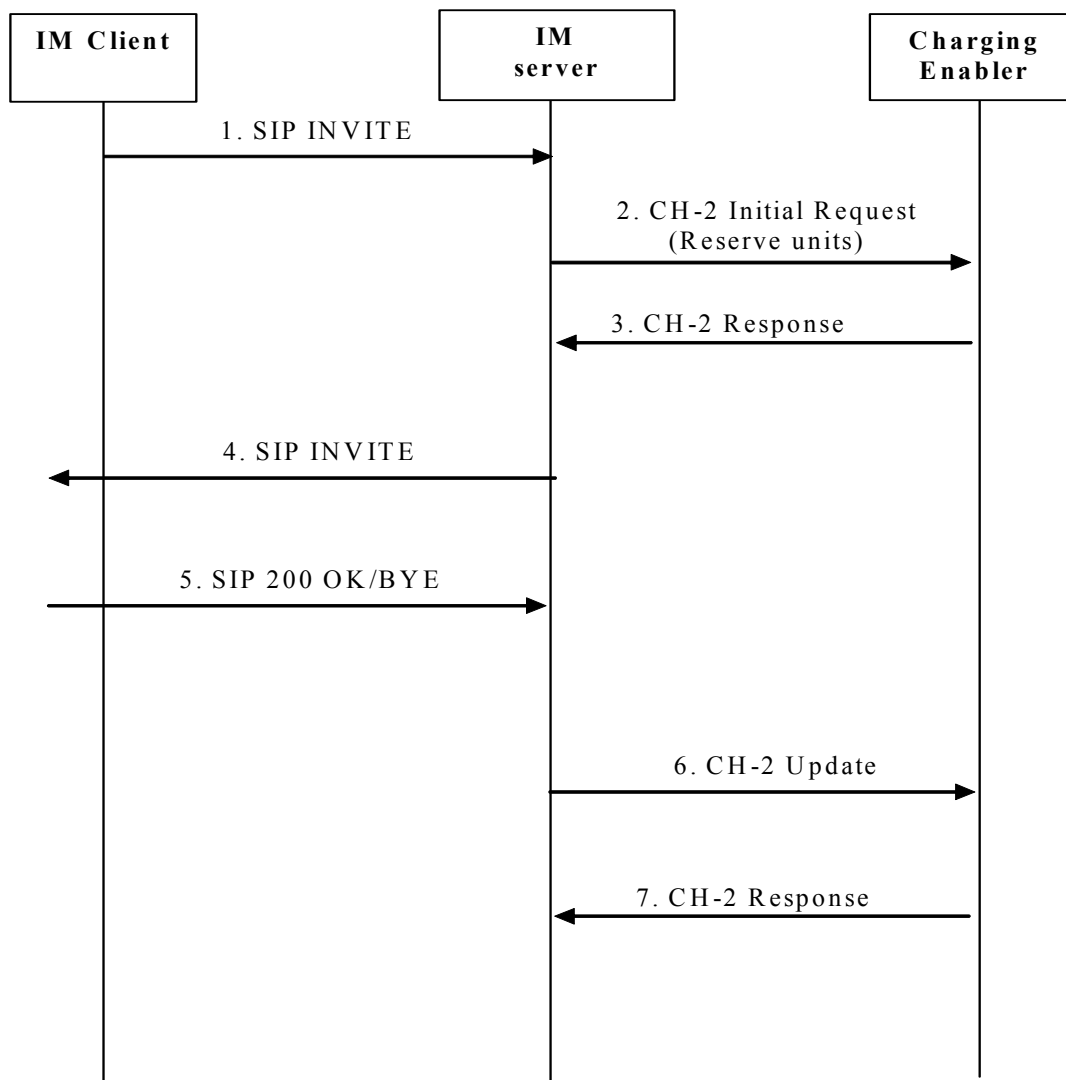

**Figure 30: Participant number based Online Charging for session owner**

1. IM Client sends [SIP INVITE] message to IM Server to create a multi-participants session.
2. IM Server sends initial CH-2 Initial Request to the Charging Enabler with pre-defined group participant number for quota reservation. In case of Ad-hoc session, IM Server sends initial CH-2 Initial Request for quota reservation with initially invited participant number.
3. The Charging Enabler acknowledges with a CH-2 Response message to IM Server with trigger type as CHANGE\_IN\_PARTICIPANTS\_NMB or CHANGE\_IN\_THRSHLD\_OF\_PARTICIPANTS\_NMB.
4. IM Server forwards the [SIP INVITE] request.

5. During the session ongoing, participant can send [SIP 200 OK] or [SIP BYE] to IM Server when joining or leaving the session.
6. In case the trigger type is CHANGE\_IN\_PARTICIPANTS\_NMB, the IM Server SHALL trigger a CH-2 Update Request toward the Charging Enabler with the changed number of participants each time a participant is joining or leaving the conference.  
In case the trigger type is CHANGE\_IN\_THRSHLD\_OF\_PARTICIPANTS\_NMB the IM Server SHALL trigger a CH-2 Update Request toward the Charging Enabler with the changed number of participants only when the threshold is reached.
7. The Charging Enabler acknowledges with a CH-2 Response message to IM Server.



## 7. Definition of charging information

### 7.1 Mapping of IM parameters to OMA charging data elements

IM specific charging information is provided within the IM Information. The detailed structure of the IM-Information can be found in **Error! Reference source not found.**

IM Field Name	Category	Type	Description	OMA Charging Data Element
Value: <a href="mailto:SIMPLE_IM@openmobilealliance.org">SIMPLE_IM@openmobilealliance.org</a>	O <sub>M</sub>	String	Fixed value to identify the service specification in the context of which the charging events must be interpreted.	Service Context Id
IM Server Role	O <sub>M</sub>	Enumerated	Identifies the IM Server function as participating function, controlling function.	Role of node
IM User Role	O <sub>C</sub>	Enumerated	Identifies if the IM user is the owner of the session or the normal participant	Role of User
IM Messaging Service	O <sub>M</sub>	Enumerated	Identifies the type of the IM session as: Pager mode, Large message mode, Session mode, conversation history .	Service Identifier
IM Message Service Type	O <sub>C</sub>	Enumerated	Identifies the type of the service as Sending, Receiving, Retrieval, Inviting, Leaving, Joining.	Application Service Type
Number of Participants	O <sub>C</sub>	Integer	Indicates the number of invited parties of the IM session when included in the initial charging request message. When included in interim / update charging messages, it indicates the number of parties currently who are attached to the session at the time the interim / update charging messages are sent.	Number Of Participants
List Of Participants	O <sub>C</sub>	String	Holds the information for participants, e.g., the addresses.	Participant Group
Called Party Address	O <sub>C</sub>	String	The address of the participants can be of the following type: - SIP URI - TEL URI	Called Party Address
IM Server Identity	O <sub>C</sub>	String	Identifies the IM Server	Application Server Id
IM Group Name	O <sub>C</sub>	String	Identifies a pre-defined group	Group Name
IM Session Id	O <sub>C</sub>	Integer	Uniquely identifies an IM session.	Application Session Id
Served Party	O <sub>M</sub>	String	Holds the identity of the party that the charging information relates to.	Subscription Id

IM Field Name	Category	Type	Description	OMA Charging Data Element
Inter Operator Identifier	O <sub>C</sub>	Integer	The IOI identifies both originating and terminating networks involved in a session/transaction. The IOI may be generated from each side of session/transaction to identify the home networks associated with each side. The orig-ioi and term-ioi parameters of P-Charging-Vector represent the originating and terminating operator identifiers. For further information regarding the composition and usage of the orig-ioi and term-ioi parameters refer to RFC 3455	Inter Operator Identifier
Access Network Identifier	O <sub>C</sub>	String	This identifies the access network and may be populated if available.	Access Network Charging Identifier Value
MSRP info	O <sub>C</sub>	Group	Identifies the information of MSRP message	Message Body
Content Type	O <sub>C</sub>	Enumerated	Identifies the	Content Type
Message Size	O <sub>C</sub>	Integer	Identifies the content summary delivered in MSRP	Content Length
Delivery status	O <sub>C</sub>	String	Identifies if the message is successfully or unsuccessfully sent	Delivery Status
Total Number of messages sent	O <sub>C</sub>	Integer	Identifies the total Number of messages (incremental) sent during a specified time interval within an IM session by a single user. It also applies to number of messages sent when not within an IM session. (see Appendix B for examples)	Total number of messages sent
Total Number of messages exploded	O <sub>C</sub>	Integer	Number of exploded message is number of messages sent multiplied by number of recipients. Identifies the total Number of messages (incremental) exploded during a specified time interval within an IM session on behalf of a single sender. It also applies to number of messages exploded when not within an IM session. (see Appendix B for examples)	Total number of messages exploded
Number of messages successfully sent	O <sub>C</sub>	Integer	Identifies the total Number of messages successfully sent by a user during a portion of an IM session. (see Appendix B for examples)	Number of messages successfully sent

IM Field Name	Category	Type	Description	OMA Charging Data Element
Number of messages successfully exploded	O <sub>C</sub>	Integer	Identifies the total Number of messages successfully exploded on behalf of a user during a portion of an IM session.  (see Appendix B for examples)	Number of messages successfully exploded
Charging Correlation Identifier	O <sub>C</sub>	<b>Integer</b>	Identifies the correlation information to correlate with bearer network. It can be populated from 'icid-value', a mandatory part of the P-Charging-Vector and coded as a text-based UTF-8 charset (as are all SIP messages). For further information regarding the composition and usage of the P-Charging-Vector refer RFC 3455 [reference code xxx]	Application Charging Identifier
SIP Method	O <sub>C</sub>		Specifies the SIP-method for which the CDR is generated. Only available in session unrelated cases.	SIP Method
Expires Information	O <sub>C</sub>		This field indicates the validity time of either the SIP message or its content, depending on the SIP method.	Expires
Service Request Time Stamp	O <sub>M</sub>		This field contains the time stamp which indicates the time at which the service was requested. This parameter corresponds to SIP Request Timestamp. Present with Charging Data Request [Start] and Charging Data Request [Event].	Event Timestamp
Service Delivery Start Time Stamp	O <sub>M</sub>		This field holds the time stamp reflecting either: successful session set-up, a delivery unrelated service, an unsuccessful session set-up and an unsuccessful session unrelated request. This parameter corresponds to SIP Response Timestamp. Present with Charging Data Request [Start] and Charging Data Request [Event].	SIP Request Timestamp
Service Delivery End Time Stamp	O <sub>C</sub>		This field records the time at which the service delivery was terminated. It is Present only in SIP session related case. This parameter corresponds to SIP Request Timestamp. Present with Charging Data Request [Stop].	SIP Response Timestamp
Service Reason Return Code	O <sub>M</sub>		This parameter provides the returned SIP status code for the service request for the successful and failure case,	Cause Code

Table 3: Structure of the IM\_Information

## Appendix A. Change History

(Informative)

### A.1 Approved Version History

Reference	Date	Description
n/a	n/a	No prior version –or- No previous version within OMA

### A.2 Draft/Candidate Version 1.0 History

Document Identifier	Date	Sections	Description
Draft version OMA-TS-SIMPLE_IM_Charging-V1_0	8 Mar 2007	All	Initial draft
	12 Apr 2007	6.2.2.1 6.2.2.2 6.2.2.6 6.2.3.5 6.3.2.1 6.3.2.3 6.3.2.4 6.3.2.5 6.2.2.8	OMA-MCC-IM_Charging-2007-0002R02 OMA-MCC-IM_Charging-2007-0003R02 OMA-MCC-IM_Charging-2007-0005R01 OMA-MCC-IM_Charging-2007-0006 OMA-MCC-IM_Charging-2007-0007 OMA-MCC-IM_Charging-2007-0008R04 OMA-MCC-IM_Charging-2007-0009R03 OMA-MCC-IM_Charging-2007-0010R04 OMA-MCC-IM_Charging-2007-0012R02
	06 May 2007	6.2.3.4 6.2.3.1 6.2.2.7 6.3.2.2 and 6.1.1 6.3.2.6 6.3.3.1 and 6.3.3.2 6.3.2.8 6.2.2.5 6.2.2.4 6 6.2.1 6.2.2.2 6.3.2.2 6.3.2.3 6 6.2.3.2	OMA-MCC-IM_Charging-2007-0004R04 OMA-MCC-IM_Charging-2007-0011R02 OMA-MCC-IM_Charging-2007-0013R01 OMA-MCC-IM_Charging-2007-0014-CR OMA-MCC-IM_Charging-2007-0015R02 OMA-MCC-IM_Charging-2007-0017R01 OMA-MCC-IM_Charging-2007-0018R01 OMA-MCC-IM_Charging-2007-0020R01 OMA-MCC-IM_Charging-2007-0021R02 OMA-MCC-IM_Charging-2007-0022 OMA-MCC-IM_Charging-2007-0023R01 OMA-MCC-IM_Charging-2007-0024 OMA-MCC-IM_Charging-2007-0025 OMA-MCC-IM_Charging-2007-0026R01 OMA-MCC-IM_Charging-2007-0030R01 OMA-MCC-IM_Charging-2007-0032R02

Document Identifier	Date	Sections	Description
	24 May 2007	1 and 4 5 and 6 and 6.1.1 and 6.1.2 6.2.1 and 6.2.2.1 and 6.2.2.2 and 6.2.2.3 and 6.2.2.4 and 6.2.2.5 and 6.2.2.6 and 6.2.2.7 and 6.2.3.1 and 6.2.3.2 and 6.2.3.3 and 6.2.3.4 and 6.2.3.5 7.1 7.1	OMA-MCC-IM_Charging-2007-0034R01  OMA-MCC-IM_Charging-2007-0035R01  OMA-MCC-IM_Charging-2007-0036R01          OMA-MCC-IM_Charging-2007-0038R02 OMA-MCC-IM_Charging-2007-0040R01
	01 Jun 2007	7.1	OMA-MCC-IM_Charging-2007-0040R01 (CR 41)
	11 Jun 2007	6.2.1 6.3.3.1 and 6.3.2.5 and 6.3.3.3 and 6.3.3.4	OMA-MCC-IM_Charging-2007-0036R01 OMA-MCC-IM_Charging-2007-0037R01
	15 Jun 2007	6.3.2.5 6.3.3.3 and 6.3.3.4 6.3.3.5 and 6.3.3.6 7.1 6.2.3.6 6.2.3.3 and 6.2.3.4 Appendix B.	OMA-MCC-IM_Charging-2007-0042R01 OMA-MCC-IM_Charging-2007-0043R01  OMA-MCC-IM_Charging-2007-0044R01  OMA-MCC-IM_Charging-2007-0045R03 OMA-MCC-IM_Charging-2007-0047R01 OMA-MCC-IM_Charging-2007-0048R01  OMA-MCC-IM_Charging-2007-0049
	10 Jul 2007	All sections 6.3.3.7	OMA-MCC-IM_Charging-2007-0064R01 OMA-MCC-IM_Charging-2007-0065R02
	13 Jul 2007	All	Editorial Clean-up
	Candidate Versions: OMA-TS-SIMPLE_IM_Charging-V1_0	16 Aug 2007	n/a

## Appendix B.

These examples clarify the meaning of the following parameters : Total Number of messages sent, Total Number of messages exploded, Number of messages successfully sent, Number of messages successfully exploded.

These charging parameters were defined for performance reasons e.g. to avoid having to send a charging record for every single message sent.

For IM sessions, these charging parameters are incremental e.g. they contain the addition of all messages sent during a certain period of time. When the charging record is sent to the charging enabler, the counter is reset to 0.

### B.1 Example 1

A participant to an IM session containing 11 participants (including himself) sends 5 messages in an IM session.

Of the 10 receivers, 8 participants receive the messages successfully. 2 participants don't receive any messages.

#### After the first message

Total Number of messages sent	1
Total Number of messages exploded	10
Number of messages successfully sent	1
Number of messages successfully exploded	8

**After 5 messages**

Total Number of messages sent	5
Total Number of messages exploded	50
Number of messages successfully sent	5
Number of messages successfully exploded	40

After this, a charging record may be sent to the charging enabler, containing the above charging parameters.

The charging parameters mentioned above are reset to 0. The accumulation (grand total of messages) is made by the charging enabler.

**B.2 Example 2**

A participant to an IM session containing 11 participants (including himself) sends 5 messages in an IM session.

4 of the 5 messages succeed, e.g. they are received successfully by at least one receiver, e.g. 8 participants receive the message successfully, 2 participants don't receive the message.

1 of the 5 messages fails, e.g. the message is not received by any of the participants.

**After 5 messages**

Total Number of messages sent	5
Total Number of messages exploded	50
Number of messages successfully sent	4
Number of messages successfully exploded	32

**B.3 Example 3**

A participant to an IM session sends 5 messages in an IM session. Some participants are joining later. e.g.

When sending the first 2 messages, there are 6 participants in the session.

When sending the next 3 messages, there are 11 participants in the session.

**After 5 messages**

Total Number of messages sent	5
Total Number of messages exploded	$5+5+10+10+10 = 40$
Number of messages successfully sent	5

Number of messages successfully exploded	$5+5+10+10+10 = 40$
--	---------------------

## B.4 Example 4

A user sends a pager mode message to a uri-list containing 10 people. 8 of them receive the message successfully.

### Result

Total Number of messages sent	1
Total Number of messages exploded	10
Number of messages successfully sent	1
Number of messages successfully exploded	8

## B.5 Example 5

A user sends a pager mode message to a uri-list containing 10 people. None of them receive the message successfully.

### Result

Total Number of messages sent	1
Total Number of messages exploded	10
Number of messages successfully sent	0
Number of messages successfully exploded	0