



# Lightweight Machine to Machine Technical Specification: Core

Approved Version: 1.2.2 - 2024-06-13

Open Mobile Alliance

OMA-TS-LightweightM2M\_Core-V1\_2\_2-20240613-A

master: 18 Jun 2024 14:22:00 rev: e58dc1c

Use of this document is subject to all of the terms and conditions of the Use Agreement located at <https://www.omaspecworks.org/about/policies-and-terms-of-use/>.

Unless this document is clearly designated as an approved specification, this document is a work in process, is not an approved Open Mobile Alliance™ specification, and is subject to revision or removal without notice.

You may use this document or any part of the document for internal or educational purposes only, provided you do not modify, edit or take out of context the information in this document in any manner. Information contained in this document may be used, at your sole risk, for any purposes. You may not use this document in any other manner without the prior written permission of the Open Mobile Alliance. The Open Mobile Alliance authorizes you to copy this document, provided that you retain all copyright and other proprietary notices contained in the original materials on any copies of the materials and that you comply strictly with these terms. This copyright permission does not constitute an endorsement of the products or services. The Open Mobile Alliance assumes no responsibility for errors or omissions in this document.

Each Open Mobile Alliance member has agreed to use reasonable endeavors to inform the Open Mobile Alliance in a timely manner of Essential IPR as it becomes aware that the Essential IPR is related to the prepared or published specification.

However, the members do not have an obligation to conduct IPR searches. The declared Essential IPR is publicly available to members and non-members of the Open Mobile Alliance and may be found on the “OMA IPR Declarations” list at <https://www.omaspecworks.org/about/intellectual-property-rights/>. The Open Mobile Alliance has not conducted an independent IPR review of this document and the information contained herein, and makes no representations or warranties regarding third party IPR, including without limitation patents, copyrights or trade secret rights. This document may contain inventions for which you must obtain licenses from third parties before making, using or selling the inventions. Defined terms above are set forth in the schedule to the Open Mobile Alliance Application Form.

NO REPRESENTATIONS OR WARRANTIES (WHETHER EXPRESS OR IMPLIED) ARE MADE BY THE OPEN MOBILE ALLIANCE OR ANY OPEN MOBILE ALLIANCE MEMBER OR ITS AFFILIATES REGARDING ANY OF THE IPR’S REPRESENTED ON THE “OMA IPR DECLARATIONS” LIST, INCLUDING, BUT NOT LIMITED TO THE ACCURACY, COMPLETENESS, VALIDITY OR RELEVANCE OF THE INFORMATION OR WHETHER OR NOT SUCH RIGHTS ARE ESSENTIAL OR NON-ESSENTIAL.

THE OPEN MOBILE ALLIANCE IS NOT LIABLE FOR AND HEREBY DISCLAIMS ANY DIRECT, INDIRECT, PUNITIVE, SPECIAL, INCIDENTAL, CONSEQUENTIAL, OR EXEMPLARY DAMAGES ARISING OUT OF OR IN CONNECTION WITH THE USE OF DOCUMENTS AND THE INFORMATION CONTAINED IN THE DOCUMENTS.

THIS DOCUMENT IS PROVIDED ON AN "AS IS" "AS AVAILABLE" AND "WITH ALL FAULTS" BASIS.

Copyright 2024 Open Mobile Alliance.

Used with the permission of the Open Mobile Alliance under the terms set forth above.

# Table of Contents

- [1. Scope](#)
  - [1.1. Revision 1.2.2](#)
  - [1.2. Revision 1.2.1](#)
  - [1.3. LwM2M version 1.2](#)
  - [1.4. LwM2M version 1.1](#)
  - [1.5. LwM2M version 1.0](#)
- [2. References](#)
  - [2.1. Normative References](#)
  - [2.2. Informative References](#)
- [3. Terminology and Conventions](#)
  - [3.1. Conventions](#)
  - [3.2. Definitions](#)
  - [3.3. Abbreviations](#)
- [4. Introduction](#)
  - [4.1. Version 1.2](#)
  - [4.2. Version 1.1](#)
  - [4.3. Version 1.0](#)
- [5. Compatibility](#)
  - [5.1. LwM2M Server and LwM2M Client Versions](#)
  - [5.2. Optional Objects and Object Versions](#)
  - [5.3. Optional Resources](#)
- [6. Interfaces](#)
  - [6.1. Bootstrap Interface](#)
    - [6.1.1. LwM2M Bootstrap-Server](#)
    - [6.1.2. Bootstrap Information](#)
    - [6.1.3. Bootstrap Modes](#)
      - [6.1.3.1. Factory Bootstrap](#)
      - [6.1.3.2. Bootstrap from Smartcard](#)
      - [6.1.3.3. Client Initiated Bootstrap](#)
      - [6.1.3.4. Server Initiated Bootstrap](#)
    - [6.1.4. Bootstrap Sequence](#)
    - [6.1.5. Bootstrap Security](#)
    - [6.1.6. Bootstrap and Configuration Consistency](#)
    - [6.1.7. Bootstrap Operations](#)
      - [6.1.7.1. Bootstrap-Request Operation](#)
      - [6.1.7.2. Bootstrap-Finish Operation](#)
      - [6.1.7.3. Bootstrap-Discover Operation](#)
      - [6.1.7.4. Bootstrap-Read Operation](#)
      - [6.1.7.5. Bootstrap-Write Operation](#)
      - [6.1.7.6. Bootstrap-Delete Operation](#)
      - [6.1.7.7. Bootstrap-Pack-Request Operation](#)
  - [6.2. Client Registration Interface](#)
    - [6.2.1. Register Operation](#)
      - [6.2.1.1. Bootstrap and LwM2M Server Registration Mechanisms](#)
      - [6.2.1.2. Behaviour with Current Transport Binding and Modes](#)
    - [6.2.2. Update Operation](#)
    - [6.2.3. De-register Operation](#)
  - [6.3. Device Management and Service Enablement Interface](#)
    - [6.3.1. Read Operation](#)
    - [6.3.2. Discover Operation](#)
    - [6.3.3. Write Operation](#)
      - [6.3.3.1. Examples](#)
    - [6.3.4. Write-Attributes Operation](#)
    - [6.3.5. Execute Operation](#)

- [6.3.6. Create Operation](#)
  - [6.3.7. Delete Operation](#)
  - [6.3.8. Read-Composite Operation](#)
  - [6.3.9. Write-Composite Operation](#)
- [6.4. Information Reporting Interface](#)
  - [6.4.1. Observe Operation](#)
  - [6.4.2. Notify Operation](#)
  - [6.4.3. Cancel Observation Operation](#)
  - [6.4.4. Observe-Composite Operation](#)
  - [6.4.5. Cancel Observation-Composite Operation](#)
  - [6.4.6. Send Operation](#)
- [7. Identifiers and Resources](#)
  - [7.1. Resource Model](#)
  - [7.2. Object Versioning](#)
    - [7.2.1. General Policy](#)
    - [7.2.2. Object Version format](#)
    - [7.2.3. Object Definition and Object Version Usage](#)
  - [7.3. Attributes](#)
    - [7.3.1. <PROPERTIES> Class Attributes](#)
    - [7.3.2. <NOTIFICATION> Class Attributes](#)
  - [7.4. Identifiers](#)
    - [7.4.1. Endpoint Client Name](#)
    - [7.4.2. Reusable Resources](#)
  - [7.5. Data Formats for Transferring Resource Information](#)
    - [7.5.1. Plain Text](#)
    - [7.5.2. Opaque](#)
    - [7.5.3. CBOR](#)
    - [7.5.4. LwM2M CBOR](#)
      - [7.5.4.1. Single Resource Example](#)
      - [7.5.4.2. Multiple Resource Example](#)
      - [7.5.4.3. Single Object Instance Example](#)
      - [7.5.4.4. Multiple Object Instances Example](#)
      - [7.5.4.5. Composite Operation Example](#)
      - [7.5.4.6. Create Operation Example](#)
    - [7.5.5. TLV](#)
      - [7.5.5.1. Single Object Instance Request Example](#)
      - [7.5.5.2. Multiple Object Instance Request Examples](#)
      - [7.5.5.3. Example of Request on an Object Instance containing an Object Link Resource](#)
    - [7.5.6. SenML JSON](#)
      - [7.5.6.1. LwM2M TS 1.0 JSON format](#)
    - [7.5.7. SenML CBOR](#)
- [8. Access Control](#)
  - [8.1. Access Control Object](#)
    - [8.1.1. Access Control Object Overview](#)
    - [8.1.2. Access Control Object Management](#)
      - [8.1.2.1. Access Control on Object](#)
      - [8.1.2.2. Access Control on Object Instance](#)
    - [8.1.3. LwM2M Access Control Context Switch](#)
  - [8.2. Authorization](#)
    - [8.2.1. Obtaining Access Right](#)
    - [8.2.2. Operation on Resource\(s\) and Object Instance\(s\)](#)
    - [8.2.3. Operation on Object](#)
    - [8.2.4. Notify Operation Consideration](#)
- [Appendix A. Change History \(Informative\)](#)
  - [A.1 Approved Version History](#)
- [Appendix B. Static Conformance Requirements](#)
- [Appendix C. Data Types \(Normative\)](#)
- [Appendix D. LwM2M Object Template and Guidelines \(Normative\)](#)

- [D.1 Object Template](#)
- [D.2 Open Mobile Naming Authority \(OMNA\) Guidelines](#)
  - [D.2.1 Object Registry](#)
  - [D.2.2 Resource Registry](#)
- [Appendix E. LwM2M Objects defined by OMA \(Normative\)](#)
  - [E.1 LwM2M Object: LwM2M Security](#)
  - [E.2 LwM2M Object: LwM2M Server](#)
  - [E.3 LwM2M Object: LwM2M Access Control](#)
  - [E.4 LwM2M Object: Device](#)
  - [E.5 LwM2M Object: Connectivity Monitoring](#)
  - [E.6 LwM2M Object: Firmware Update](#)
    - [E.6.1 Firmware Update State Machine](#)
    - [E.6.2 Examples](#)
    - [E.6.3 Firmware Update Consideration](#)
  - [E.7 LwM2M Object: Location](#)
  - [E.8 LwM2M Object: Connectivity Statistics](#)
  - [E.9 LwM2M Object: LWM2M OSCORE](#)
  - [E.10 LwM2M Object: LwM2M COSE](#)
  - [E.11 LwM2M Object: MQTT Server](#)
  - [E.12 LwM2M Object: LwM2M Gateway](#)
  - [E.13 LwM2M Object: LwM2M Gateway Routing](#)
  - [E.14 LwM2M Object: 5G NR Connectivity](#)
- [Appendix F. Example LwM2M Client \(Informative\)](#)
- [Appendix G. Storage of LwM2M Bootstrap Information on the Smartcard \(Normative\)](#)
  - [G.1 File structure](#)
  - [G.2 Bootstrap Information on UICC](#)
    - [G.2.1 Access to the file structure](#)
    - [G.2.2 Files Overview \(example\)](#)
    - [G.2.3 Access Method](#)
    - [G.2.4 Access Conditions](#)
    - [G.2.5 Requirements on the Device](#)
  - [G.3 Files Description](#)
    - [G.3.1 EF\(DIR\) – optional](#)
    - [G.3.2 Object Directory File, EF\(ODF\)](#)
    - [G.3.3 Data Object Directory File, EF\(DODF-bootstrap\)](#)
    - [G.3.4 EF \(LwM2M\\_Bootstrap\)](#)
- [Appendix H. Secure channel between Smartcard and LwM2M Device Storage for secure Bootstrap Data provisioning \(Normative\)](#)
- [I Media Types \(Normative\)](#)
  - [I.1 Media-Type application/vnd.oma.lwm2m+tlv Registration](#)
  - [I.2 Media-Type application/vnd.oma.lwm2m+json Registration](#)
  - [I.3 Media-Type application/vnd.oma.lwm2m+cbor Registration](#)
- [Appendix J. LwM2M Schema and Object Definition File \(Informative\)](#)
- [Appendix K. LwM2M Schema \(Normative\)](#)
- [Appendix L. Example of Trigger Message from Server \(Informative\)](#)
- [Appendix M. SenML CBOR Example \(Informative\)](#)

## Table of Figures

[Figure: 4.-1 The overall architecture of the LwM2M Enabler](#)

[Figure: 6.-1 Bootstrap Interface with Bootstrap-Request operation](#)

[Figure: 6.-2 Bootstrap Interface with Bootstrap-Pack-Request operation](#)

[Figure: 6.-3 Client Registration](#)

[Figure: 6.-4 Device Management and Service Enablement](#)

[Figure: 6.-5 Information Reporting](#)

[Figure: 6.1.3.3.-1 Client Initiated Bootstrap with Bootstrap-Request operation](#)

[Figure: 6.1.3.3.-2 Client Initiated Bootstrap with Bootstrap-Pack-Request operation](#)

[Figure: 6.1.3.4.-1 Procedure of Server Initiated Bootstrap initiated by an authorized LwM2M Server](#)

[Figure: 6.2.-1 Client Registration Interface example flows](#)

[Figure: 6.2.1.1.-1 Ordered Servers Procedure](#)

[Figure: 6.2.1.1.-2 Single Ordered Server Procedure](#)

[Figure: 6.2.1.1.-3 Single Unordered Server Procedure](#)

[Figure: 6.2.2.-1 Update Example Flow #1](#)

[Figure: 6.2.2.-2 Update Example Flow #2](#)

[Figure: 6.3.-1 Example flows of Device Management & Service Enablement Interface](#)

[Figure: 6.4.-1 Example flow for Information Reporting Interface for the RSSI Resource of the Connectivity Monitoring Object of the example client Appendix LwM2M Objects defined by OMA \(Normative\)](#)

[Figure: 6.4.2.-1 Example of Minimum and Maximum periods in an Observation](#)

[Figure: 7.1.-1 Relationship between LwM2M Client, Object, and Resources](#)

[Figure: 7.1.-2 Example of Supported operations and Associated Access Control Object Instance](#)

[Figure: 7.5.5.-1 TLV nesting](#)

[Figure: 8.1.2.2.-1 Illustration of the relations between the LwM2M Access Control Object and the other LwM2M Objects](#)

[Figure: C.-1 Object link Resource simple illustration](#)

[Figure: E.6.1-1 Firmware Update Mechanisms](#)

[Figure: E.6.2-1 Example of a LwM2M Server pushing a firmware image to a LwM2M client](#)

[Figure: E.6.2-2 Example of a client fetching a firmware image](#)

[Figure: G.2.2-1 Example of a UICC File Structure embedding a specific PKCS\#15 file structure containing LwM2M Bootstrap data location](#)

[Figure: H.-1 Bootstrap Information transfer from Smartcard to LwM2M Device using Secure Channel according to \[GLOBALPLATFORM\]](#)

## Table of Tables

[Table: 2.1.-1 Normative References](#)

[Table: 2.2.-1 Informative References](#)

[Table: 3.2.-1 Definitions](#)

[Table: 3.3.-1 Abbreviations](#)

[Table: 6.-1 Relationship of operations and interfaces](#)

[Table: 6.1.2.-1 Bootstrap Information List](#)

[Table: 6.1.7.1.-1 Bootstrap-Request Parameters](#)

[Table: 6.1.7.3.-1 Bootstrap-Discover Parameters](#)

[Table: 6.1.7.4.-1 Bootstrap-Read Parameters](#)

[Table: 6.1.7.4.-2 Bootstrap-Read Example with Multiple Object Instances](#)

[Table: 6.1.7.5.-1 "Bootstrap-Write" Parameters](#)

[Table: 6.1.7.6.-1 Bootstrap-Delete Parameters](#)

[Table: 6.1.7.7.-1 Bootstrap-Pack-Request Parameters](#)

[Table: 6.1.7.7.-2 Bootstrap-Pack Example with Multiple Objects and Multiple Object Instances](#)

[Table: 6.2.1.-1 Registration Parameters](#)

[Table: 6.2.1.1.-1 Registration Procedures Default Values](#)

[Table: 6.2.1.2.-1 Behaviour with Current Transport Bindings](#)

[Table: 6.2.2.-1 Update Parameters](#)

[Table: 6.3.1.-1 Read Parameters](#)

[Table: 6.3.2.-1 Discover Parameters](#)

[Table: 6.3.2.-2 Depth Modifier](#)

[Table: 6.3.3.-1 Write Parameters](#)

[Table: 6.3.4.-1 Write-Attributes Parameters](#)

[Table: 6.3.5.-1 Execute parameters](#)

[Table: 6.3.6.-1 Create parameters](#)

[Table: 6.3.7.-1 Delete parameters](#)

[Table: 6.4.1.-1 Observe Parameters](#)

[Table: 6.4.2.-1 Notify Parameters](#)

[Table: 7.3.-1 Attribute Characteristics](#)

[Table: 7.3.1.-1 <PROPERTIES> Class Attributes](#)

[Table: 7.3.2.-1 <NOTIFICATION> class Attributes](#)

[Table: 7.4.-1 LwM2M Identifiers](#)

[Table: 7.4.1.-1 Endpoint Client Name](#)

[Table: 7.4.1.-2 Deprecated Endpoint Client Name](#)

[Table: 7.5.-1 IANA registered Media Types supported in LwM2M TS 1.0](#)

[Table: 7.5.-2 Additional standardized Media Types supported in LwM2M TS 1.1](#)

[Table: 7.5.-3 Additional IANA registered Media Type supported in LwM2M TS 1.2](#)

[Table: 7.5.5.-1 TLV format and description](#)

[Table: 7.5.5.1.-1 Single Object Instance Request Example](#)

[Table: 7.5.5.2.-1 Request on Single-Instance Object](#)

[Table: 7.5.5.2.-2 Request on Multiple-Instance Object having 2 instances](#)

[Table: 7.5.5.2.-3 Example, a request to the Server Object Instances of an LwM2M client is performed \(Read /1\)](#)

[Table: 7.5.5.3.-1 Example 1\) Request to Object 65 Instance 0: Read /65/0](#)

[Table: 7.5.5.3.-2 Example 2\) request to Object 66: Read /66: TLV payload will contain 2 Object Instances](#)

[Table: 7.5.6.-1 SenML JSON format and description](#)

[Table: 7.5.6.-2 SenML JSON payload returned from example request to Device Object \(Read /3/0\)](#)

[Table: 7.5.6.-3 SenML JSON payload from example notification about a Resource containing multiple historical representations of a Temperature Resource](#)

[Table: 7.5.6.-4 SenML JSON payload returned from example request to Object 65 of the LwM2M example seen on Figure: C.-1 Object link Resource simple illustration \(Read /65/0\)](#)

[Table: 7.5.6.-5 SenML JSON payload returned from example request to Device Object on Resource 0 of the LwM2M example client \(Read /3/0/0\)](#)

[Table: 7.5.6.-6 SenML JSON payload in the server request to read manufacturer name, battery level and registration lifetime](#)

[Table: 7.5.6.-7 SenML JSON payload in the client response to server request to read manufacturer name, battery level and registration lifetime](#)

[Table: 7.5.6.-8 SenML JSON payload in the server request to read Network Bearer, Available Network Bearer, Radio Signal Strength and Location](#)

[Table: 7.5.6.-9 SenML JSON payload in the server Write-Composite to switch off /3311/0 and /3311/1, while dimming /3311/2](#)

[Table: 7.5.6.-10 SenML JSON payload in the request to all objects](#)

[Table: 7.5.6.-11 SenML JSON payload in the request to all object instances of the LwM2M Server Object](#)

[Table: 7.5.6.-12 SenML JSON payload in the request to all resources of the first and third instance of the LwM2M Server Object](#)

[Table: 8.1.2.1.-1 Access Control on Object](#)

[Table: 8.1.2.2.-1 Access Control on Object Instance](#)

[Table: 8.2.-1 Authorization](#)

[Table: A.1-1 Approved Version History](#)

[Table: C.-1 Data Types](#)

[Table: C.-2 Data Type Mapping](#)

[Table: D.1-1 Object definition](#)

[Table: D.1-2 Resource definition](#)

[Table: D.1-3 Executable Resource Arguments Definition](#)

[Table: D.2.1-1 LwM2M Object Classes](#)

[Table: E.-1 LwM2M Objects](#)

[Table: E.1-1 LwM2M Object: LWM2M Security object definition](#)

[Table: E.1-2 LwM2M Object: LWM2M Security Resource definitions](#)

[Table: E.2-1 LwM2M Object: LwM2M Server object definition](#)

[Table: E.2-2 LwM2M Object: LwM2M Server Resource definitions](#)

[Table: E.3-1 LwM2M Object: LwM2M Access Control object definition](#)

[Table: E.3-2 LwM2M Object: LwM2M Access Control Resource definitions](#)

[Table: E.4-1 LwM2M Object: Device object definition](#)

[Table: E.4-2 LwM2M Object: Device Resource definitions](#)

[Table: E.4-3 Battery Status](#)

[Table: E.5-1 LwM2M Object: Connectivity Monitoring object definition](#)

[Table: E.5-2 LwM2M Object: Connectivity Monitoring Resource definitions](#)

[Table: E.6-1 LwM2M Object: Firmware Update object definition](#)

[Table: E.6-2 LwM2M Object: Firmware Update Resource definitions](#)

[Table: E.7-1 LwM2M Object: Location object definition](#)

[Table: E.7-2 LwM2M Object: Location Resource definitions](#)

[Table: E.8-1 LwM2M Object: Connectivity Statistics object definition](#)

[Table: E.8-2 LwM2M Object: Connectivity Statistics Resource definitions](#)

[Table: E.9-1 LwM2M Object: LWM2M OSCORE object definition](#)

[Table: E.9-2 LwM2M Object: LWM2M OSCORE Resource definitions](#)

[Table: E.10-1 LwM2M Object: LwM2M COSE object definition](#)

[Table: E.10-2 LwM2M Object: LwM2M COSE Resource definitions](#)

[Table: E.11-1 LwM2M Object: MQTT Server object definition](#)

[Table: E.11-2 LwM2M Object: MQTT Server Resource definitions](#)

[Table: E.12-1 LwM2M Object: LwM2M Gateway object definition](#)

[Table: E.12-2 LwM2M Object: LwM2M Gateway Resource definitions](#)

[Table: E.13-1 LwM2M Object: LwM2M Gateway Routing object definition](#)

[Table: E.13-2 LwM2M Object: LwM2M Gateway Routing Resource definitions](#)

[Table: E.14-1 LwM2M Object: 5G NR Connectivity object definition](#)

[Table: E.14-2 LwM2M Object: 5G NR Connectivity Resource definitions](#)

[Table: F.-1 Object Instances of the example](#)

[Table: F.-2 LwM2M Security Object \[0\]](#)

[Table: F.-3 LwM2M Security Object \[1\]](#)

[Table: F.-4 LwM2M Security Object \[2\]](#)

[Table: F.-5 LwM2M Server Object \[0\]](#)

[Table: F.-6 LwM2M Server Object \[1\]](#)

[Table: F.-7 Access Control Object \[0\] \(for the LwM2M Server Object Instance 0\)](#)

[Table: F.-8 Access Control Object \[1\] \(for the LwM2M Server Object Instance 1\)](#)

[Table: F.-9 Access Control Object \[2\] \(for the Device Object Instance\)](#)

[Table: F.-10 Access Control Object \[3\] \(for the Connectivity Monitoring Object Instance\)](#)

[Table: F.-11 Access Control Object \[4\] \(for the Firmware Update Object\)](#)

[Table: F.-12 Device Object Instance](#)

[Table: F.-13 Connectivity Monitoring Object Instance](#)

[Table: G.3.2-1 Object Directory File, EF ODF](#)

[Table: G.3.3-1 Bootstrap Data Object Directory File, EF DODF-bootstrap](#)

[Table: G.3.4-1 EF LwM2M Bootstrap](#)

[Table: L.-1 Example WAP Push over SMS containing the trigger information](#)

[Table: L.-2 Example WAP Push over SMS containing the trigger information](#)

# 1. Scope

This document, the LwM2M CORE technical specification, describes the LwM2M messaging layer. The LwM2M TRANSPORT specification [LwM2M-TRANSPORT], a companion specification, details the mapping of the messaging layer to selected transports. The separation between transport and messaging layer improves readability and simplifies extending LwM2M to further transports. The LwM2M messaging layer uses a RESTful design with several interfaces and a simple data model.

## 1.1. Revision 1.2.2

Please refer to the ERELD LwM2M for details what has changed.

For detail changes, please refer to this link for [deltas between v1.2.2 and v1.2.1](#).

## 1.2. Revision 1.2.1

This revision of the specification includes the following fixes or clarifications:

- Add an optional parameter to the Bootstrap-Pack-Request operation.
- Fix a possible ambiguity when LwM2M CBOR is used in the Create operation.
- Rewrite the text describing the usage of attributes for clarity and simplification.
- Clarify that each argument to the Execute operation is unique.
- Clarify that the LwM2M COSE Object must not be part of the "Objects and Object Instances" parameter of the Register operation.
- Clarify that the LwM2M COSE Object and the MQTT Server Object are part of the response to a Bootstrap-Discover operation.
- Indicate the LwM2M CBOR content format assigned number.
- Consolidate the list of recommended URN formats for the Endpoint Client Name.
- Move the Attributes section to the Identifiers and Resources section.
- Fix the SenML JSON syntax in the Bootstrap-Pack example.
- Fix the binary in the EF DODF-bootstrap example in Appendix G.
- Fix the examples of the "Arguments" parameter of the Execute operation to remove unauthorized spaces.
- Fix the reference of [OSCORE].

## 1.3. LwM2M version 1.2

This specification defines version 1.2 of the LwM2M protocol and augments [LwM2M-TS\_1.1]. Version 1.2 is backwards compatible to LwM2M version v1.0 and v1.1 with respect to mandatory features.

LwM2M v1.2 adds the following new features:

- New transports for LwM2M; this allows LwM2M messaging to be conveyed over MQTT and over HTTP.
- Optimizations for the bootstrapping interface; this reduces the amount of data and the number of messages transmitted during the bootstrapping exchange.
- Optimizations for the registration interface; this reduces the amount of data transmitted during registration exchanges.
- Optimizations for the information reporting interface; observation attributes may now be included in an Observe operation.
- Support for LwM2M gateway functionality; this allows non-LwM2M IoT devices as well as LwM2M devices behind a gateway to be connected to the LwM2M ecosystem and to manage those devices remotely.
- New, highly optimized encoding format based on CBOR called LwM2M CBOR.
- Enhanced functionality for firmware updates.
- Definition of new notification attributes (edge, confirmable notification, and maximum historical queue). Edge allows notifications to be triggered on rising and falling edges. Confirmable notifications allow the control of reliable transmissions of notifications. Maximum historical queue allows the control of time-series data usage.
- Clarifications of object versioning rules.

- Updates to use the latest communication security protocols based on TLS and DTLS 1.3 (as well as the use of the Connection ID).
- Flexibility to control the use of TLS and DTLS 1.3 through configuration information.
- Untangling the relationship of security credentials and their server configuration.

There also numerous clarifications and editorial improvements as well as additional examples based on feedbacks received from the LwM2M development community.

Details about the transport bindings can be found in [LwM2M-TRANSPORT].

#### 1.4. LwM2M version 1.1

LwM2M v1.1 added the following features to v1.0:

- Enhancement of the LwM2M bootstrapping capabilities allowing for incremental upgrades.
- Improved support for Public Key Infrastructure (PKI) deployments.
- Introduction of enhanced registration sequence mechanisms by the LwM2M Client to LwM2M Server(s).
- Support for LwM2M over TCP/TLS to better support firewall and NAT traversal.
- Support for application layer security for LwM2M based on OSCORE.
- Better support of LwM2M over Low Power WANs, including 3GPP CIoT & LoRaWAN.
- Extended LwM2M operations to enable Resource Instance level access.
- Performance improvement for retrieving and updating Resources of multiple objects.
- Support for JSON using SenML with CBOR serialization for compressed payload with highly efficient transmission.
- Addition of new data types.

#### 1.5. LwM2M version 1.0

LwM2M v1.0 offers the following features:

- Simple resource model with the core set of objects and resources defined in this specification. The full list of registered objects can be found at [OMNA](#).
- Operations for creation, update, deletion, and retrieval of resources.
- Asynchronous notifications of resource changes.
- Support for several serialization formats, namely TLV, JSON, Plain Text and binary data formats and the core set of LightweightM2M Objects.
- UDP and SMS transport support.
- Communication security based on the DTLS protocol supporting different types of credentials.
- Queue Mode offers functionality for a LwM2M Client to inform the LwM2M Server that it may be disconnected for an extended period and when it becomes reachable again.
- Support for use of multiple LwM2M Servers.
- Provisioning of security credentials and access control lists by a dedicated LwM2M bootstrap-server.

## 2. References

### 2.1. Normative References

[LwM2M-TRANSPORT]	Open Mobile Alliance, "Lightweight Machine to Machine Technical Specification: Transport Layer"
[LwM2M-TS_1.0]	Open Mobile Alliance, "Lightweight Machine to Machine Technical Specification, Version 1.0.2", February 2018
[LwM2M-TS_1.1]	Open Mobile Alliance, "Lightweight Machine to Machine Technical Specification, Version 1.1.1", June 2019
[DMREPPRO]	"OMA Device Management Representation Protocol, Version 1.3", Open Mobile Alliance™, OMA-TS-DM_RepPro-V1_3, <a href="http://www.openmobilealliance.org/">URL:http://www.openmobilealliance.org/</a>
[OMADICT]	"Dictionary for OMA Specifications", Open Mobile Alliance™, OMA-ORG-Dictionary-V2_9, <a href="http://www.openmobilealliance.org/">URL:http://www.openmobilealliance.org/</a>
[OMNA]	"OMNA Lightweight M2M (LwM2M) Object & Resource Registry", <a href="http://www.openmobilealliance.org/">URL:http://www.openmobilealliance.org/</a>
[3GPP 23.003]	3GPP TS 23.003 "Numbering, addressing and identification"
[3GPP 23.032]	3GPP TS 23.032 "Universal Geographical Area Description (GAD)"
[3GPP 23.401]	3GPP TS 23.401 "General Packet Radio Service (GPRS) enhancements for Evolved Universal Terrestrial Radio Access Network (E-UTRAN) access"
[3GPP 24.008]	3GPP TS 24.008 "Mobile radio interface Layer 3 specification; Core network protocols; Stage 3"
[3GPP 25.331]	3GPP TS 25.331 "Radio Resource Control (RRC); Protocol specification"
[3GPP 31.115]	3GPP TS 31.115 "Secured packet structure for (Universal) Subscriber Identity Module (U)SIM Toolkit applications"
[3GPP 31.116]	3GPP TS 31.116 "Remote APDU Structure for (U)SIM Toolkit applications"
[3GPP 36.133]	3GPP TS 36.133 "Evolved Universal Terrestrial Radio Access (E-UTRA); Requirements for support of radio resource management"
[3GPP 36.214]	3GPP TS 36.214 "Evolved Universal Terrestrial Radio Access (E-UTRA); Physical layer; Measurements"
[3GPP 44.018]	3GPP TS 44.018 "Mobile radio interface layer 3 specification; GSM/EDGE Radio Resource Control (RRC) protocol"
[3GPP2 C.50078-0]	3GPP2 C.50078-0 (V1.0): "Secured packet structure for CDMA Card Application Toolkit (CCAT) applications"
[3GPP2 C.50079-0]	3GPP2 C.50079-0 (V1.0) "Remote APDU Structure for CDMA Card Application Toolkit (CCAT) applications"
[ETSI 102 221]	ETSI TS 102 221 "Smart Cards; UICC-Terminal interface; Physical and logical characteristics", <a href="http://www.etsi.org/">URL:http://www.etsi.org/</a>
[ETSI 102 223]	ETSI TS 102 223 "Smart Cards; Card Applications Toolkit (CAT)", <a href="http://www.etsi.org/">URL:http://www.etsi.org/</a>
[ETSI 102 225]	ETSI TS 102 225 "Smart Cards; Secured packet structure for UICC based applications", <a href="http://www.etsi.org/">URL:http://www.etsi.org/</a>
[ETSI 102 226]	ETSI TS 102 226 "Smart cards; Remote APDU structure for UICC based applications", <a href="http://www.etsi.org/">URL:http://www.etsi.org/</a>
[CoAP]	Z. Shelby, K. Hartke, C. Bormann, B. Frank, "The Constrained Application Protocol (CoAP)", June 2014, <a href="http://www.ietf.org/rfc/rfc7252.txt">URL:http://www.ietf.org/rfc/rfc7252.txt</a>
[CoAP_Blockwise]	C. Bormann, Z. Shelby, "Block-wise transfers in CoAP", August 2016, <a href="http://www.ietf.org/rfc/rfc7959.txt">URL:http://www.ietf.org/rfc/rfc7959.txt</a>
[Cond_Attr]	M. Koster, A. Soloway, B. Silverajan, Ed., "Conditional Attributes for Constrained RESTful Environments", (work in progress) <a href="https://tools.ietf.org/html/draft-ietf-core-conditional-attributes">draft-ietf-core-conditional-attributes</a> , May 2022
[FLOAT]	ANSI/IEEE Std 754-2019, "IEEE Standard for Floating-Point Arithmetic", IEEE Microprocessor Standards Committee, July 2019
[GLOBALPLATFORM]	GlobalPlatform Card Specification V2.3.1 (GPC_SPE_034), <a href="http://www.globalplatform.org/">URL:http://www.globalplatform.org/</a>
[OSCORE]	G. Selander, J. Mattsson, F. Palombini, L. Seitz, "Object Security for Constrained RESTful Environments (OSCORE)", July 2019, <a href="https://tools.ietf.org/html/rfc8613">URL:https://tools.ietf.org/html/rfc8613</a>
[PKCS#15]	"PKCS #15 v1.1: Cryptographic Token Information Syntax Standard", RSA Laboratories, June 6, 2000, <a href="ftp://ftp.cert.dfn.de/pub/pca/docs/PKCS/ftp.rsa.com/pkcs-15/pkcs-15v1_1.pdf">URL:ftp://ftp.cert.dfn.de/pub/pca/docs/PKCS/ftp.rsa.com/pkcs-15/pkcs-15v1_1.pdf</a>

[SENML]	C. Jennings, Z. Shelby, J. Arkko, A. Keranen, C. Bormann, "Sensor Measurement Lists (SenML)", July 2018, <a href="https://tools.ietf.org/html/rfc8428.txt">URL:https://tools.ietf.org/html/rfc8428.txt</a>
[TR-069]	Broadband Forum: "TR-069 CPE WAN Management Protocol" Issue: 1 Amendment 5", <a href="http://www.broadband-forum.org/technical/download/TR-069_Amendment-5.pdf">URL:http://www.broadband-forum.org/technical/download/TR-069_Amendment-5.pdf</a>
[WGS84]	World Geodetic System 1984 (WGS 84), <a href="https://earth-info.nga.mil/GandG/update/index.php?dir=wgs84&amp;action=wgs84">URL:https://earth-info.nga.mil/GandG/update/index.php?dir=wgs84&amp;action=wgs84</a>
[BCP 14]	"Key words for use in RFCs to Indicate Requirement Levels", B. Leiba, May 2017, URL:https://www.rfc-editor.org/info/bcp14
[RFC2119]	"Key words for use in RFCs to Indicate Requirement Levels", S. Bradner, March 1997, URL:https://www.rfc-editor.org/rfc/rfc2119.txt
[RFC8174]	"Ambiguity of Uppercase vs Lowercase in RFC 2119 Key Words", B. Leiba, May 2017, URL:https://www.rfc-editor.org/rfc/rfc8174.txt
[RFC3986]	T. Berners-Lee, R. Fielding, L. Masinter, "Uniform Resource Identifier (URI): Generic Syntax", January 2005 <a href="http://www.ietf.org/rfc/rfc3986.txt">URL:http://www.ietf.org/rfc/rfc3986.txt</a>
[RFC4648]	P. S. Josefsson, "The Base16, Base32, and Base64 Data Encodings", October 2006 <a href="http://www.ietf.org/rfc/rfc4648.txt">URL:http://www.ietf.org/rfc/rfc4648.txt</a>
[RFC6234]	D. Eastlake 3rd, T. Hansen, "US Secure Hash Algorithms (SHA and SHA-based HMAC and HKDF)", May 2011, <a href="http://www.ietf.org/rfc/rfc6234.txt">URL:http://www.ietf.org/rfc/rfc6234.txt</a>
[RFC6690]	Shelby, Z. "Constrained RESTful Environments (CoRE) Link Format", August 2012, <a href="http://www.ietf.org/rfc/rfc6690.txt">URL:http://www.ietf.org/rfc/rfc6690.txt</a>
[RFC6920]	S. Farrell, D. Kutscher, C. Dannewitz, B. Ohlman, A. Keranen, P. Hallam-Baker, "Naming Things with Hashes", April 2013, <a href="https://tools.ietf.org/rfc/rfc6920.txt">URL:https://tools.ietf.org/rfc/rfc6920.txt</a>
[RFC7542]	A. DeKok, "The Network Access Identifier", May 2015 <a href="https://tools.ietf.org/rfc/rfc7542.txt">URL:https://tools.ietf.org/rfc/rfc7542.txt</a>
[RFC8790]	A. Keränen, M. Mohajer, "FETCH and PATCH with Sensor Measurement Lists (SenML)", June 2020, <a href="https://tools.ietf.org/rfc/rfc8790.txt">URL:https://tools.ietf.org/rfc/rfc8790.txt</a>
[RFC8949]	AC. Bormann, P. Hoffman, "Concise Binary Object Representation (CBOR)", December 2020, <a href="https://tools.ietf.org/rfc/rfc8949.txt">URL:https://tools.ietf.org/rfc/rfc8949.txt</a>
[ISO/IEC 7812-1]	Identification cards – Identification of issuers – Part 1: Numbering system.

Table: 2.1.-1 Normative References

## 2.2. Informative References

[3GPP 23.682]	3GPP TS 23.682 "Architecture enhancements to facilitate communications with packet data networks and applications"
[3GPP 23.720]	3GPP TR 23.720 "Study on architecture enhancements for Cellular Internet of Things"
[3GPP 24.301]	3GPP TS 24.301 "Non-Access-Stratum (NAS) protocol for Evolved Packet System (EPS); Stage 3"
[3GPP 27.060]	3GPP TS 27.060 "Packet domain; Mobile Station (MS) supporting Packet Switched services"
[3GPP 29.061]	3GPP TS 29.061 "Interworking between the Public Land Mobile Network (PLMN) supporting packet based services and Packet Data Networks (PDN)"
[3GPP 31.102]	3GPP TS 31.102 "Characteristics of the Universal Subscriber Identity Module (USIM) application"
[RFC4122]	P. Leach, M. Mealling, R. Salz, "A Universally Unique Identifier (UUID) URN Namespace", July 2005, <a href="https://tools.ietf.org/html/rfc4122">URL:https://tools.ietf.org/html/rfc4122</a>
[RFC5612]	P. Leach, M. Mealling, R. Salz, "A Universally Unique Identifier (UUID) URN Namespace", July 2005, <a href="https://tools.ietf.org/html/rfc5612">URL:https://tools.ietf.org/html/rfc5612</a>
[RFC7254]	M. Montemurro, A. Allen, D. McDonald, P. Gosden, "A Uniform Resource Name Namespace for the Global System for Mobile Communications Association (GSMA) and the International Mobile station Equipment Identity (IMEI)", May 2014, <a href="https://tools.ietf.org/html/rfc7254">URL:https://tools.ietf.org/html/rfc7254</a>
[RFC7459]	M. Thomson, J. Winterbottom, "Representation of Uncertainty and Confidence in the Presence Information Data Format Location Object (PIDF-LO)", February 2015, <a href="https://tools.ietf.org/html/rfc7459">URL:https://tools.ietf.org/html/rfc7459</a>
[RFC8141]	P. Saint-Andre, J. Klensin, "Uniform Resource Names (URNs)", April 2017, <a href="https://tools.ietf.org/html/rfc8141">URL:https://tools.ietf.org/html/rfc8141</a>
[RFC8464]	R. Atarius, "A URN Namespace for Device Identity and Mobile Equipment Identity (MEID)", September 2018, <a href="https://tools.ietf.org/html/rfc8464">URL:https://tools.ietf.org/html/rfc8464</a>
[RFC9039]	J. Arkko, C. Jennings, Z. Shelby, "Uniform Resource Names for Device Identifiers", June 2021, <a href="https://tools.ietf.org/html/rfc9039">URL:https://tools.ietf.org/html/rfc9039</a>

Table: 2.2.-1 Informative References

## 3. Terminology and Conventions

### 3.1. Conventions

The key words "MUST", "MUST NOT", "REQUIRED", "SHALL", "SHALL NOT", "SHOULD", "SHOULD NOT", "RECOMMENDED", "NOT RECOMMENDED", "MAY", and "OPTIONAL" in this document are to be interpreted as described in BCP 14 [RFC2119] [RFC8174] when, and only when, they appear in all capitals, as shown here.

All sections and appendixes, except "Scope" and "Introduction", are normative, unless they are explicitly indicated to be informative.

### 3.2. Definitions

<b>Object</b>	An Object is a collection of logically related resources.
<b>Object Instance</b>	An Object Instance is one occurrence of an Object.
<b>Resource</b>	A Resource is an atomic unit of information.
<b>Resource Instance</b>	A Resource Instance is one occurrence of a Resource.
<b>LwM2M Client</b>	Component running on a device implementing the LwM2M protocol for interacting with the LwM2M Server and the LwM2M Bootstrap-Server. LwM2M Clients are often implemented in IoT devices and gateways.
<b>LwM2M Server</b>	Component implementing the server-side functionality of the LwM2M protocol for interacting with a LwM2M Client. Typically, the LwM2M Server software is running on a non-IoT device, such as an on-premise server or in a cloud-based infrastructure.
<b>LwM2M Bootstrap-Server</b>	The LwM2M Bootstrap-Server is a server responsible for provisioning essential information, including credentials, into the LwM2M Client to enable the LwM2M Client to perform the "Register" operation with one or more LwM2M Servers. Very often, the LwM2M Bootstrap-Server is the first LwM2M entity a LwM2M Client interacts with. The Bootstrap Interface is the only interface used between the LwM2M Client and the LwM2M Bootstrap-Server.
<b>LwM2M Bootstrap-Server Account</b>	LwM2M Security Object Instance with Bootstrap-Server Resource true, potentially with an associated LwM2M OSCORE Object Instance, LwM2M COSE Object Instance and/or MQTT Server Object Instance
<b>LwM2M Server Account</b>	LwM2M Server Object Instance and associated LwM2M Security Object Instance with Bootstrap-Server Resource false, potentially with an associated LwM2M OSCORE Object Instance, LwM2M COSE Object Instance and/or MQTT Server Object Instance
<b>LwM2M Registration Session</b>	An LwM2M Registration Session is an association between a LwM2M Client and a LwM2M Server. It starts with the successful LwM2M register operation and ends when the registration lifetime expires, with a successful LwM2M de-register operation or when an error is detected.
<b>LwM2M Bootstrap Session</b>	An LwM2M Bootstrap Session is an association between a LwM2M Client and a LwM2M Bootstrap-Server. It starts with the successful Bootstrap-Request or Bootstrap-Pack-Request operation and ends respectively with the Bootstrap-Finish or Bootstrap-Pack operation or when an error is detected.
<b>Transport Session</b>	A Transport Session is application-independent association between the LwM2M Client and LwM2M Server or LwM2M Bootstrap-Server to enable application layer communications.

Table: 3.2.-1 Definitions

Kindly consult [OMADICT] for more definitions used in this document.

### 3.3. Abbreviations

3GPP	3rd Generation Partnership Project
------	------------------------------------

AID	Application Identifier
ABNF	Augmented Backus-Naur Form
ACL	Access Control List
AEAD	Authenticated Encryption with Additional Data
AES	Advanced Encryption Standard
APN	Access Point Name
ASCII	American Standard Code for Information Interchange
ASN.1	Abstract Syntax Notation #1
CA	Certification Authority
CBOR	Concise Binary Object Representation
CDMA	Code Division Multiple Access
CIoT	Cellular Internet of Things
CoAP	Constrained Application Protocol
CoRE	Constrained RESTful Environments
COSE	CBOR Object Signing and Encryption
CRS	Coordinate Reference Systems
DF	Dedicated File
DER	Distinguished Encoding Rules
DIR	Directory File
DO	Data Object
DODF	Data Object Directory File
DSL	Digital Subscriber Line
DTLS	Datagram Transport Layer Security
EDGE	Enhanced Data rates for GSM Evolution
EF	Elementary File
ESN	Electronic Serial Number
EST	Enrollment over Secure Transport
FDD	Frequency Division Duplex
GSM	Global System for Mobile
HKDF	MAC-based Key Derivation Function
HMAC	Hashed Message Authentication Code
HTTP	Hypertext Transfer Protocol
HTTPS	HTTP Secure
IANA	Internet Assigned Numbers Authority
ICCID	Integrated Circuit Card Identification Number
ID	Identity/Identifier
IE	Information(al) Element
IEEE	Institute of Electrical and Electronic Engineers

IMEI	International Mobile Equipment Identity
IMSI	International Mobile Subscriber Identity
IP	Internet Protocol
IPSO	Internet Protocol for Smart Objects
ISDN	Integrated Services Digital Network
JOSE	Javascript Object Signing and Encryption
JSON	JavaScript Object Notation
kB	Kilobyte; one kilobyte is 1000 bytes
KiB	Kibibyte; one kibibyte is 1024 bytes
Kic	Key and algorithm Identifier for ciphering
kID	Key and algorithm Identifier
LAC	Location Area Code
LoRaWAN	LOng RAnge Wide Area Network
LQI	Link Quality Indicator
LSB	Least Significant Bit
LTE	Long Term Evolution
LwM2M	Lightweight M2M
M2M	Machine to Machine
MEID	Mobile Equipment Identifier
MQTT	Message Queuing Telemetry Transport
MSISDN	Mobile Subscriber ISDN Number
MSB	Most Significant Bit
NAI	Network Access Identifier
NB-IoT	NarrowBand Internet of Things
NRSRQ	Narrowband Reference Signal Received Quality
OCSP	Online Certificate Status Protocol
ODF	Object Directory File
OID	Object ID
OMNA	Open Mobile Naming Authority
OSCORE	Object Security for Constrained RESTful Environments
PDN	Packet Data Network
PDU	Protocol Data Unit Data Network
PFS	Perfect Forward Secrecy
PIX	Proprietary application Identifier eXtension
PKI	Public Key Infrastructure
PKCS	Public Key Cryptography Standard
PLC	Power Line Communications
PSK	Pre-Shared Key

RID	Registered application provider IDentifier
RDS	Reliable Data Service
RPK	Raw Public Key
RSCP	Received Signal Code Power
RSRP	Reference Signal Received Power
RSRQ	Reference Signal Received Quality
RSSI	Received Signal Strength Indicator
RTT	Round Trip Time
RX	Receive
SCEF	Service Capability Exposure Function
SCR	Static Conformance Requirements
SenML	Sensor Measurement Lists
SHA	Secure Hash Algorithm
SINR	Signal to Interference plus Noise Ratio
SMCC	Serving Mobile Country Code
SMNC	Serving Mobile Network Code
SMS	Short Message Service
SNI	Server Name Indication
SPI	Security Parameters Indication
TAR	Toolkit Application Reference
TCP	Transmission Control Protocol
TD-SCMACP	Time Division Synchronous Code Division Multiple Access
TDD	Time Domain Duplex
TLS	Transmission Layer Security
TVL	Type-Length-Value
TX	Transmit
TZ	Timezone
TLS	Transport Layer Security
UDH	User-Data-Header
UDHL	UDH Length
UDP	User Datagram Protocol
UICC	Universal Integrated Circuit Card
UML	Unified Modeling Language
UMTS	Universal Mobile Telephone System
URI	Uniform Resource Identifier
URN	Uniform Resource Name
USB	Universal Serial Bus
UTC	Universal Time Coordinated

UTF	Unicode Transformation Format
UTRAN	UMTS Terrestrial Radio Access Network
UICC	Universally Unique Identifier
WAP	Wireless Application Protocol
WCDMA	Wideband Code Division Multiple Access
WDP	Wireless Datagram Protocol
WiMAX	Worldwide Interoperability for Microwave Access
WLAN	Wireless Local Area Network
WSP	Wireless Session Protocol
XML	eXtensible Markup Language

Table: 3.3. -1 Abbreviations

## 4. Introduction

This enabler defines the application layer communication protocol between a LwM2M Server and a LwM2M Client as well as between the LwM2M Bootstrap-Server and the LwM2M Client. The LwM2M Device includes a LwM2M Client component. The OMA Lightweight M2M enabler includes device management and service enablement for LwM2M Devices. This device management protocol was designed to make use of lightweight protocols and an efficient data model.

The LwM2M messaging layer is inspired by the RESTful design model based on [CoAP]. Interactions are between clients and servers using request/response model. Uniform Resource Identifiers (URIs) are used to identify and interact with object and resources while the protocol allows stateless and layered architecture.

Four interfaces are designed between the three entities, as shown in the architecture in [Figure: 4.-1 The overall architecture of the LwM2M Enabler](#):

- Bootstrap
- Client Registration
- Device Management and Service Enablement
- Information Reporting

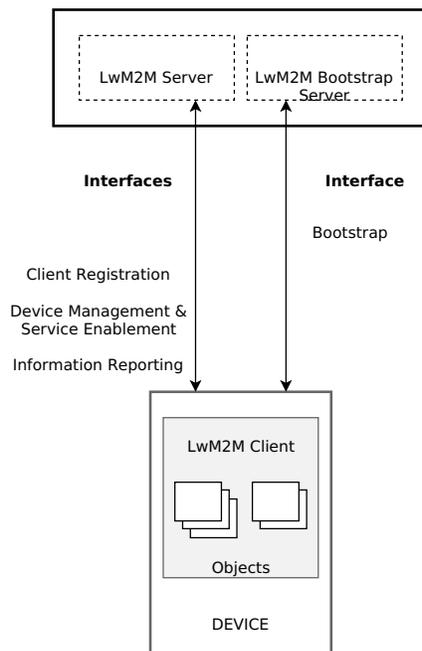

Figure: 4.-1 The overall architecture of the LwM2M Enabler

### 4.1. Version 1.2

Version 1.2 of LwM2M introduced the following objects, which are part of core specification:

- LwM2M COSE (Object ID:23)
- MQTT Server (Object ID:24)
- LwM2M Gateway (Object ID:25)
- LwM2M Gateway Routing (Object ID:26)

- 5G-NR Connectivity Object (Object ID:27)

Version 1.2 of LwM2M modified the following objects, which are part of core specification:

- LwM2M Security Object (Object ID:0)
- LwM2M Server Object (Object ID:1)
- Firmware Update Object (Object ID:5)
- LwM2M OSCORE Object (Object ID:21)

## 4.2. Version 1.1

[LwM2m-TS\_1.1] introduced the following objects, which are part of core specification:

- OSCORE Object (Object ID:21)

[LwM2m-TS\_1.1] modified the following objects, which are part of core specification:

- LwM2M Security Object (Object ID:0)
- LwM2M Server Object (Object ID:1)
- Device Object (Object ID:3)
- Connectivity Monitoring Object (Object ID:4)

## 4.3. Version 1.0

[LwM2M-TS\_1.0] introduced the following objects, which are part of core specification:

- LwM2M Security Object (Object ID:0)
- LwM2M Server Object (Object ID:1)
- LwM2M Access Control Object (Object ID:2)
- Device Object (Object ID:3)
- Connectivity Monitoring Object (Object ID:4)
- Firmware Update Object (Object ID:5)
- Location Object (Object ID:6)
- Connectivity Statistics Object (Object ID:7)

## 5. Compatibility

### 5.1. LwM2M Server and LwM2M Client Versions

The LwM2M Server **MUST** support a LwM2M Client of the same major and minor version. For example, a LwM2M Server whose version is 1.2 **MUST** support a LwM2M Client whose version is 1.2.

The LwM2M Server **SHOULD** support all LwM2M Client versions of the same major version. Backward compatibility with a common major version is strongly recommended to support deployment scenarios where LwM2M Servers are updated before the LwM2M Clients. For example, a LwM2M Server whose version is 1.2 should support LwM2M Clients that are version 1.0 or 1.1. Forward compatibility with a common major version is also recommended to support deployment scenarios where the LwM2M Clients are updated before the LwM2M Server. For example, a LwM2M Server whose version is 1.1 should support a LwM2M Client whose version is 1.2.

### 5.2. Optional Objects and Object Versions

Operations initiated by the LwM2M Client to the LwM2M Server may address optional objects that are not supported by the LwM2M Server. Similarly, operations initiated by the LwM2M Server to the LwM2M Client may address objects that are not supported by the LwM2M Client. This may occur because the objects are not recognized or the object versions are not compatible.

### 5.3. Optional Resources

Operations initiated by the LwM2M Client to the LwM2M Server may address optional resources that are not supported by the LwM2M Server. Operations initiated by the LwM2M Server to the LwM2M Client may address optional resources that are not supported by the LwM2M Client.

To enable compatibility between LwM2M Clients and LwM2M Servers for optional resources that are not supported, the LwM2M Client or LwM2M Server, when possible, **MUST NOT** interpret transactions targeted at those resources as errors.

## 6. Interfaces

According to [Figure: 4.-1 The overall architecture of the LwM2M Enabler](#) there are four interfaces: 1) Bootstrap, 2) Client Registration, 3) Device Management and Service Enablement, and 4) Information Reporting. The operations for the four interfaces can be classified into uplink operations and downlink operations. The operations for each interface are defined in this section, and then mapped to protocol mechanisms in the LwM2M Transport specification [LwM2M-TRANSPORT].

[Figure: 6.-1 Bootstrap Interface with Bootstrap-Request operation](#) and [Figure: 6.-2 Bootstrap Interface with Bootstrap-Pack-Request operation](#) show the operation model for the "Bootstrap" interface. For this interface, the operations are uplink operations named "Bootstrap-Request" and "Bootstrap-Pack-Request", downlink operations named "Bootstrap-Discover", "Bootstrap-Write", "Bootstrap-Read", "Bootstrap-Delete" and "Bootstrap-Finish". These operations are used to initialize the needed Object(s) for the LwM2M Client to register with one or more LwM2M Server(s). When a "Bootstrap-Write" operation initiated on the "Bootstrap" interface by the LwM2M Bootstrap-Server, the LwM2M Client MUST write the value included in the payload regardless of an existence of the targeting Object Instance(s) or Resource(s) and access rights. In the mode where the LwM2M Bootstrap-Server is addressing the Bootstrap Information to the LwM2M Client when initiated with "Bootstrap-Request", the LwM2M Bootstrap-Server MUST inform the LwM2M Client when this transfer is over by sending a "Bootstrap-Finish" operation.

In addition to the bootstrapping interface the required information for the LwM2M Client to function with LwM2M Server(s) may also be configured during manufacturing (called Factory Bootstrap) or via a smartcard (called Smartcard Bootstrap).

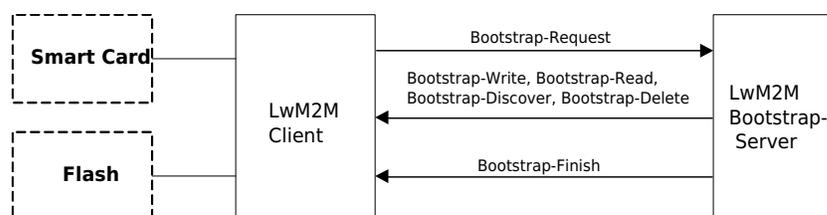

Figure: 6.-1 Bootstrap Interface with Bootstrap-Request operation

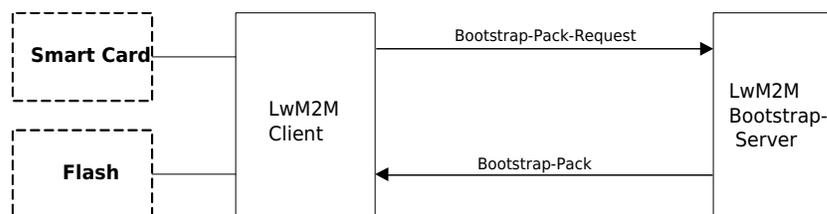

Figure: 6.-2 Bootstrap Interface with Bootstrap-Pack-Request operation

[Figure: 6.-3 Client Registration](#) shows the operation model for the interface "Client Registration". For this interface, the operations are uplink operations named "Registration", "Update" and "De-register".

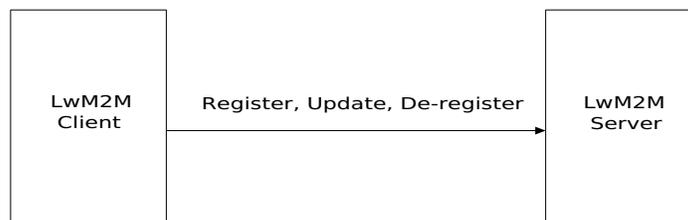

Figure: 6.-3 Client Registration

[Figure: 6.-4 Device Management and Service Enablement](#) shows the operational model for the "Device Management and Service Enablement" interface. For this interface, the downlink operations are "Read", "Read-Composite", "Create", "Delete", "Write", "Write-Composite", "Execute", "Write-Attributes", and "Discover". These operations are used to interact with Resources, Resource Instances, Objects, Object Instances and/or their attributes exposed by the LwM2M Client. The "Read" and "Read-Composite" operations are used to read the current values. The "Discover" operation is used to discover attributes and to discover which Resources are implemented in a certain Object. The "Write" and "Write-Composite" operations are used to update values. The "Write-Attributes" operation is used to change attribute values. The "Execute" operation is used to initiate an action. The "Create" and "Delete" operations are used to create and delete Instances, respectively.

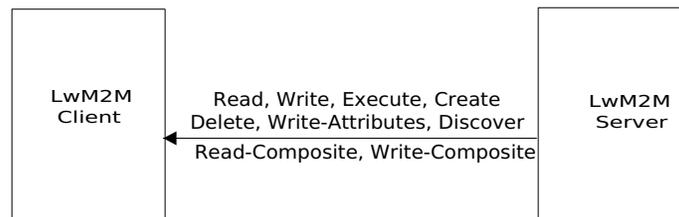

Figure: 6.-4 Device Management and Service Enablement

[Figure: 6.-5 Information Reporting](#) shows the operational model for the "Information Reporting" interface. For this interface, the downlink operations are "Observe", "Observe-Composite", "Cancel Observation", and "Cancel Observation-Composite". The "Notify" is an uplink operation, which is used to send a new value of a Resource from the LwM2M Client to the LwM2M Server. The "Send" operation is another uplink operation which is used by the LwM2M Client to send data to the LwM2M Server.

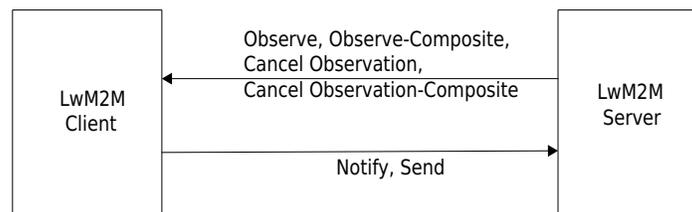

Figure: 6.-5 Information Reporting

The relationship between operations and interfaces is listed in [Table: 6.-1 Relationship of operations and interfaces](#).

Interface	Direction	Operation
Bootstrap	Uplink	Bootstrap-Request, Bootstrap-Pack-Request
Bootstrap	Downlink	Bootstrap-Write, Bootstrap-Read, Bootstrap-Discover, Bootstrap-Delete, Bootstrap-Finish
Client Registration	Uplink	Register, Update, De-register
Device Management and Service Enablement	Downlink	Create, Read, Read-Composite, Write, Delete, Execute, Write-Attributes, Write-Composite, Discover
Information Reporting	Downlink	Observe, Observe-Composite, Cancel Observation, Cancel Observation-Composite
Information Reporting	Uplink	Notify, Send

Table: 6.-1 Relationship of operations and interfaces

## 6.1. Bootstrap Interface

The Bootstrap Interface is used to provision essential information into the LwM2M Client to enable the LwM2M Client to perform the "Register" operation with one or more LwM2M Servers.

There are four bootstrap modes supported by the LwM2M Enabler:

- Factory Bootstrap
- Bootstrap from Smartcard
- Client Initiated Bootstrap
- Server Initiated Bootstrap

The last two Bootstrap modes require the help of an LwM2M Bootstrap-Server to achieve the ultimate goal to connect a LwM2M Client to their LwM2M Server(s). As specified in Section [6.1.3.4. Server Initiated Bootstrap](#), the "Server Initiated Bootstrap" mode is a method to invoke the "Client Initiated Bootstrap" mode.

The LwM2M Client MUST support at least one bootstrap mode specified in the Bootstrap Interface.

The LwM2M Bootstrap-Server MUST support the "Client Initiated Bootstrap" mode with the "Bootstrap-Request" operation specified in the Bootstrap Interface. The LwM2M Bootstrap-Server MAY support the "Client Initiated Bootstrap" mode with the "Bootstrap-Pack-Request" operation specified in the Bootstrap Interface.

This section describes what information is conveyed across the Bootstrap Interface, where the LwM2M Client puts that information and how to provision the Bootstrap Information for each of these bootstrap modes. [LwM2M-TRANSPORT] provides further security-relevant information concerning the bootstrap techniques.

### 6.1.1. LwM2M Bootstrap-Server

The LwM2M Bootstrap-Server is used to provision the LwM2M Client with the information required to contact the LwM2M Server(s).

In order for the LwM2M Client and the LwM2M Bootstrap-Server to establish a connection on the Bootstrap Interface, either in Client Initiated Bootstrap mode or in Server Initiated Bootstrap mode, the LwM2M Client MUST have an LwM2M Bootstrap-Server Account pre-provisioned.

Note: During the Bootstrap Phase the LwM2M Client MAY ignore requests and flush all pending responses not related to the Bootstrap sequence.

### 6.1.2. Bootstrap Information

This section specifies the information that needs to be configured for a LwM2M Client to connect to LwM2M Server(s) or to the LwM2M Bootstrap-Server. This Bootstrap Information can be available before performing the Bootstrap Sequence described in Section [6.1.4. Bootstrap Sequence](#) or obtained as a result of the Bootstrap Sequence.

Bootstrap Information can be categorized into two types:

- LwM2M Server Bootstrap Information
- LwM2M Bootstrap-Server Bootstrap Information

Bootstrap Information Type	Entity	Required
The LwM2M Server Bootstrap Information	LwM2M Server Account	Yes*
	Additional Object Instances (e.g. Access Control, Connectivity Monitoring Object)	No
The LwM2M Bootstrap-Server Bootstrap Information	LwM2M Bootstrap-Server Account (LwM2M Security Object Instance + potential LwM2M OSCORE Object Instance + potential LwM2M COSE Object Instance + potential MQTT Server Object Instance)	No

Table: 6.1.2. -1 Bootstrap Information List

The LwM2M Client MUST have the LwM2M Server Bootstrap Information after the bootstrap sequence specified in Section [6.1.4. Bootstrap Sequence](#). The LwM2M Server Bootstrap Information is used by the LwM2M Client to register and connect to the LwM2M Server.

The LwM2M Client SHOULD have the LwM2M Bootstrap-Server Bootstrap Information. The LwM2M Server Bootstrap Information MUST contain at least one LwM2M Server Account.

Note that according to the LwM2M Server Account definition, a usual LwM2M Server Account is composed of a LwM2M Security Object Instance and a LwM2M LwM2M Server Object Instance which are paired by sharing (respectively in Resource 10 and Resource 0 of that Objects) the same Short Server ID; a Short Server ID being unique in the LwM2M Client. Note also that a Security Object Instance may potentially be associated to a LwM2M OSCORE Object Instance by means of an Object Link (Resource 17 of the LwM2M Security Object Instance), a LwM2M COSE Object Instance by means of an Object Link (Resource 27 of the LwM2M Security Object Instance), and/or a MQTT Server Object Instance by means of an Object Link (Resource 26 of the LwM2M Security Object Instance), .

The LwM2M Server Bootstrap Information MAY additionally contain further Object Instances (e.g. Access Control, Connectivity Monitoring Object).

The LwM2M Client MAY be configured to use one or more LwM2M Server Account(s).

The LwM2M Client MUST have at most one LwM2M Bootstrap-Server Account.

The LwM2M Bootstrap-Server Bootstrap Information is used by the LwM2M Client to contact the LwM2M Bootstrap-Server to get the LwM2M Server Bootstrap Information.

The LwM2M Bootstrap-Server Bootstrap Information MUST be an LwM2M Bootstrap-Server Account.

(\*) The LwM2M Client MUST have at least one LwM2M Server Account after completion of Bootstrap Sequence specified in Section [6.1.4. Bootstrap Sequence](#).

Please note that the LwM2M Client MUST accept Bootstrap Information sent via Bootstrap Interface without applying access control, as specified in Section [8.2. Authorization](#).

### 6.1.3. Bootstrap Modes

The following sub-sections provide further information for the four Bootstrap modes.

#### 6.1.3.1. Factory Bootstrap

In this mode, the LwM2M Client has been configured with the necessary bootstrap information prior to deployment of the device. The configured information may be the LwM2M Bootstrap-Server Bootstrap Information and/or the LwM2M Server Bootstrap Information.

#### 6.1.3.2. Bootstrap from Smartcard

When the Device supports a Smartcard, the LwM2M Client MUST retrieve and process the bootstrap data contained in the Smartcard as described in [Appendix G. Storage of LwM2M Bootstrap Information on the Smartcard \(Normative\)](#). When the bootstrap data retrieval is successful, the LwM2M Client MUST process the bootstrap data from the Smartcard and SHOULD apply the Bootstrap Information to its configuration to enhance security benefits.

Due to the sensitive nature of the Bootstrap Information, a secure channel SHOULD be established between the Smartcard and the LwM2M Device.

When such a secure channel is established between the Smartcard and the LwM2M Device, this secure channel MUST be based on [GLOBALPLATFORM] procedure, mainly described in Section [Appendix H. Secure channel between Smartcard and LwM2M Device Storage for secure Bootstrap Data provisioning \(Normative\)](#).

In this Bootstrap mode, the LwM2M Client MUST also ensure that the bootstrap data previously retrieved from the Smartcard is unchanged within the Smartcard. If bootstrap data is changed, and if the previous Bootstrap Information was applied from Smartcard, this previous Bootstrap Information MUST be disabled in the LwM2M Client and the

LwM2M Client SHOULD apply the new Bootstrap Information from Smartcard to its configuration.

If the Smartcard is disabled (e.g. removing the Smartcard) then the Bootstrap Information created from the bootstrap data of the previous Smartcard MUST be deleted.

Checking for Smartcard change and disabling MUST be performed by the LwM2M Client, each time a "Register" or "Update" operation take place, with a LwM2M Server provisioned from Smartcard. As usual, the Bootstrap security rules (see Section [6.1.5. Bootstrap Security](#)) then apply.

NOTE: Bootstrap Information in Smartcard can be updated by using Smartcard OTA protocol as specified in [ETSI 102 225] / [ETSI 102 226] and extensions such as [3GPP 31.115] / [3GPP 31.116] and [3GPP2 C.S0078-0] / [3GPP2 C.S0079-0].

### 6.1.3.3. Client Initiated Bootstrap

The "Client Initiated Bootstrap" mode provides a mechanism for the LwM2M Client to retrieve Bootstrap Information from an LwM2M Bootstrap-Server. The "Client Initiated Bootstrap" mode requires an LwM2M Bootstrap-Server Account preloaded in the LwM2M Client.

At a minimum a LwM2M Client needs to have DTLS/TLS and/or OSCORE [OSCORE] security credentials preloaded to authenticate to an LwM2M Bootstrap-Server.

Before entering the "Client Initiated Bootstrap" mode, the LwM2M Client may be registered to LwM2M Servers. Whether or not the LwM2M Client keeps these registrations active during the Client Initiated Bootstrap is implementation dependent.

[Figure: 6.1.3.3.-1 Client Initiated Bootstrap with Bootstrap-Request operation](#) and [Figure: 6.1.3.3.-2 Client Initiated Bootstrap with Bootstrap-Pack-Request operation](#) depict protocol exchange graphically for two different ways to perform Client Initiated Bootstrap.

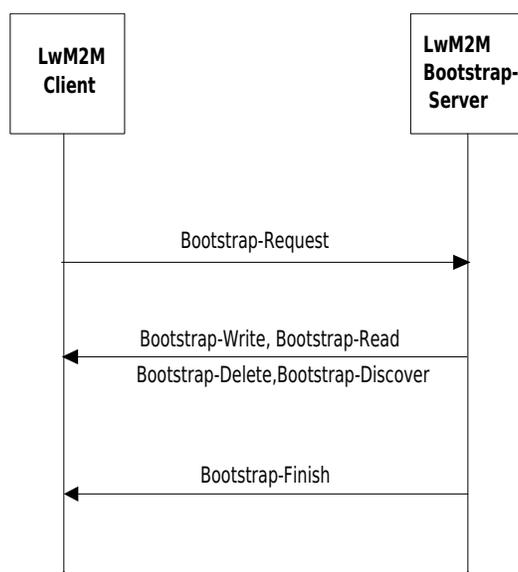

Figure: 6.1.3.3.-1 Client Initiated Bootstrap with Bootstrap-Request operation

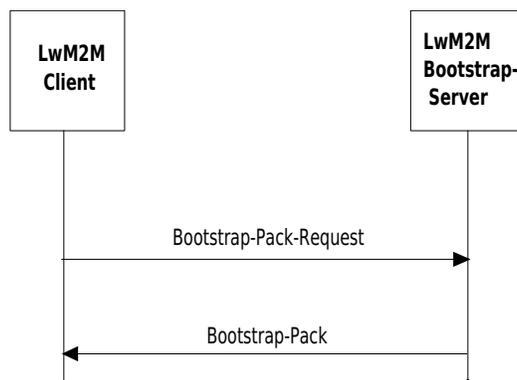

Figure: 6.1.3.3.-2 Client Initiated Bootstrap with Bootstrap-Pack-Request operation

Step #0: Bootstrap-Request or Bootstrap-Pack-Request to bootstrap URI

The LwM2M Client sends a "Bootstrap-Request" or "Bootstrap-Pack-Request" operation to LwM2M Bootstrap-Server URI, which has been pre-provisioned. When requesting the bootstrap, the LwM2M Client SHOULD send the LwM2M Client's "Endpoint Client Name" as a parameter to allow the LwM2M Bootstrap-Server to provision the proper bootstrap information for the LwM2M Client. The LwM2M Client MAY omit "Endpoint Client Name" if it is equal to the identifier utilized in the security protocol.

Step #1: Configure Bootstrap Information

The LwM2M Bootstrap-Server configures the LwM2M Client with the Bootstrap Information using the "Write" and/or "Delete" operations or using "Bootstrap-Pack", depending on the operation used in Step #0.

This Bootstrap mode MAY be used to configure some Resources of the Bootstrap Information in the LwM2M Client after initial bootstrap to update Bootstrap Information. In this case, all Bootstrap Information is OPTIONAL.

Step #2: Bootstrap-Finish

When the LwM2M Server has finished sending the Bootstrap Information to the LwM2M Client, the Server MUST send the "Bootstrap-Finish" operation to the Client to properly end this phase. "Bootstrap-Finish" operation is not required if the Bootstrap Information is sent to the client using a "Bootstrap-Pack".

If "Bootstrap-Request" operation is used in Step #0, the bootstrap procedure fails when the LwM2M Client does not receive the "Bootstrap-Finish" operation after the EXCHANGE\_LIFETIME time period expired. The EXCHANGE\_LIFETIME parameter is defined in [CoAP].

Step #3: Clean-up after successful Bootstrapping

Successful Bootstrapping means that the Bootstrap-Finish operation has been received by the LwM2M Client, if the "Bootstrap-Request" has been used in Step #0, and the loaded configuration is considered consistent by the LwM2M Client. In this case the Bootstrap-Finish response sent to the LwM2M Bootstrap-Server should indicate a success code. If Bootstrapping was unsuccessful, the Bootstrap-Server Account MUST retain the values it had before the unsuccessful Bootstrapping sequence started and further statements below in Step #3 do not apply. If Bootstrapping was unsuccessful using "Bootstrap-Pack-Request", the LwM2M Client MUST retry bootstrapping with "Bootstrap-Request".

In the case the LwM2M Client is registered to a LwM2M Server, if the matching LwM2M Server Account was deleted, the LwM2M Client MUST consider itself de-registered from the LwM2M Server. Note that if the matching LwM2M Server Account was modified, the LwM2M Client may need to update its registration to the LwM2M Server depending on the nature of the modifications.

If the Bootstrap-Server Account Timeout Resource is instantiated in the LwM2M Security Object Instance of the Bootstrap-Server, the LwM2M Client MUST purge the LwM2M Bootstrap-Server Account after the expiration time provided by the value of this Resource. If this Resource is not instantiated or its value is set to 0, the Bootstrap-Server Account lifetime is infinite (Section [E.1 LwM2M Object: LwM2M Security](#)).

High entropy keys that are unique per device SHOULD be used for the LwM2M Bootstrap-Server Account. In that case the LwM2M Bootstrap-Server Account SHOULD be kept after bootstrapping i.e. the Bootstrap-Server Account Timeout Resource may be set to 0, or may stay not instantiated.

In case the Bootstrap-Server Account has to be replaced, the replacement and the purge of the previous Bootstrap-Server Account MUST properly take place before the Client sends the Bootstrap-Finish response message back to the Bootstrap-Server; otherwise a "Not Acceptable" Response MUST be returned, and the previous Bootstrap-Server Account is still the only one active.

Note: If the original LwM2M Bootstrap-Server Account is purged from the device, and a new LwM2M Bootstrap-Server Account has not been created, further adding or removing of LwM2M Server Accounts will no longer be possible. Furthermore, updating security credentials e.g. X.509 certificates will also no longer be possible.

#### 6.1.3.4. Server Initiated Bootstrap

In this mode the decision to trigger a Bootstrap Sequence is made by an authorized LwM2M Server. The LwM2M Server triggers the LwM2M Client to enter the "Client Initiated Bootstrap" mode rather than initiating a different protocol for configuring the Bootstrap Information in the LwM2M Client.

The trigger mechanism is performed through the execution of the "Bootstrap-Request Trigger" Resource available from the related Server Object Instance. A connection between a LwM2M Client and a LwM2M Server must already exist to enter this "Server Initiated Bootstrap" mode.

Note: proprietary mechanisms can be used to cause a LwM2M Client to enter the standard "Client Initiated Bootstrap" mode, but that is outside the scope of this specification.

The figure below depicts the "Server Initiated Bootstrap" flow initiated by an authorized LwM2M Server.

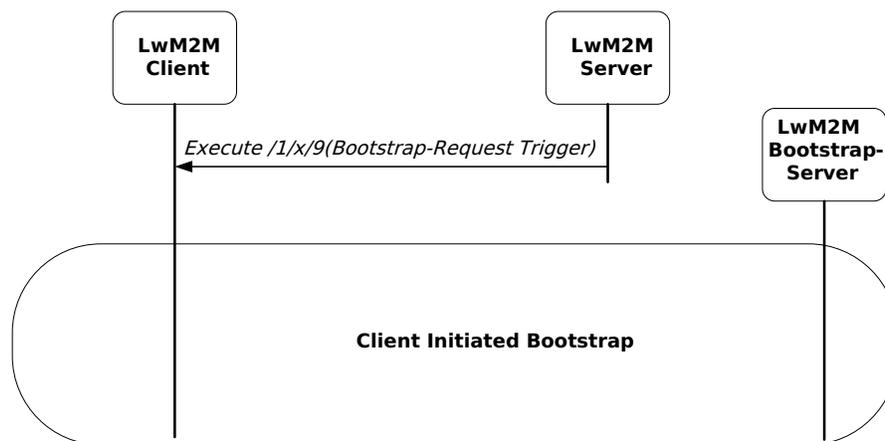

Figure: 6.1.3.4.-1 Procedure of Server Initiated Bootstrap initiated by an authorized LwM2M Server

#### 6.1.4. Bootstrap Sequence

The LwM2M Client MUST respect step by step the procedural sequence specified below when attempting to bootstrap an LwM2M Device:

1. If the LwM2M Device has Smartcard, the LwM2M Client tries to obtain Bootstrap Information from the Smartcard using the Bootstrap from Smartcard mode. Any Server Initiated Bootstrap attempt MUST be ignored by the LwM2M Client until it has tried to bootstrap via Smartcard or Factory Bootstrap mode.
2. If the LwM2M Client is not configured using the Bootstrap from Smartcard mode, the LwM2M Client tries to obtain the Bootstrap Information by using Factory Bootstrap mode. Any Server Initiated Bootstrap attempt MUST be ignored by the LwM2M Client until it has tried to bootstrap via Smartcard or Factory Bootstrap mode.

3. If the LwM2M Client has any LwM2M Server Object Instances from the previous steps, the LwM2M Client tries to register to the LwM2M Server(s) configured in the LwM2M Server Object Instance(s).
4. If the LwM2M Client fails to register to all the LwM2M Servers or the Client doesn't have any LwM2M Server Object Instances, the LwM2M Client performs the Client Initiated Bootstrap.
5. A Server Initiated Bootstrap attempt (e.g. for updating a LwM2M Server Account) remains possible, but only if the LwM2M Client retains the corresponding LwM2M Bootstrap-Server Account.

### 6.1.5. Bootstrap Security

The information conveyed through the Bootstrap Interface is sensitive and requires communication security to be used. The security requirements for the Bootstrap Interface is discussed in [LwM2M-TRANSPORT].

### 6.1.6. Bootstrap and Configuration Consistency

When a Bootstrap Information is loaded in the LwM2M Client, any detected inconsistency **MUST** be reported in sending an error response code to the Bootstrap-Finish operation. If the Bootstrap Information is delivered to the LwM2M Client with "Bootstrap-Pack", in case of any inconsistency, the LwM2M Client **MUST** retry bootstrapping with "Bootstrap-Request" operation.

As an example, during a Bootstrap phase, a Multi-Servers Configuration is loaded in a LwM2M Client with the associated Instances of the Access Control Object, while this particular LwM2M Client is not supporting the Access Control Object itself (Single Server context support only). In that case, the client is not able to find a satisfactory consistent configuration by itself, so that the Bootstrap sequence cannot be ended successfully.

On receipt of the error response code to the Bootstrap-Finish operation, the Bootstrap-Server **MAY** take corrective actions before issuing a new Bootstrap-Finish operation.

As specified in Section [6.1.3. Bootstrap Modes](#), the LwM2M Client **MUST** consider the Bootstrap procedure is failed when the LwM2M Client didn't receive a Bootstrap-Finish operation in a certain period (EXCHANGE\_LIFETIME), if the bootstrap was initiated with "Bootstrap-Request" operation.

### 6.1.7. Bootstrap Operations

The mapping to underlying transports is detailed in [LwM2M-TRANSPORT].

The Bootstrap operations are used to help the Bootstrap-Server of setting a proper configuration in a LwM2M Client especially in the case of an incremental Bootstrap procedure for which a particular care must be observed to preserve the Client consistency (e.g. adding a new Server Account without breaking the access rights already in place in the targeted LwM2M Client).

#### 6.1.7.1. Bootstrap-Request Operation

The Bootstrap-Request operation is only performed to initiate the Bootstrap Sequence in the "Client Initiated Bootstrap" mode.

The Bootstrap-Request operation has the following parameters:

Parameter	Required	Default Value	Notes
Endpoint Client Name	No	-	Indicates the LwM2M Client's "Endpoint Client Name". This parameter is optional if it is equal to the identifier in the security protocol and deployment is such that the security protocol identifier is always available for the server (e.g. no proxies in between).
Preferred Content Format	No	-	Indicates the numeric ID of the LwM2M Client's preferred Content Format for bootstrap configuration. The Content Format ID MUST be one of the SenML JSON, SenML CBOR, LwM2M CBOR, or TLV formats defined in Section <a href="#">7.5. Data Formats for Transferring Resource Information</a> .

Table: 6.1.7.1.-1 Bootstrap-Request Parameters

### 6.1.7.2. Bootstrap-Finish Operation

The Bootstrap-Finish operation is performed to terminate the Bootstrap Sequence previously initiated in "Client Initiated Bootstrap" mode (or in "Server Initiated Bootstrap" mode by extension).

This operation informs the LwM2M Client, that all the Bootstrap Information have been provided by the LwM2M Bootstrap-Server.

### 6.1.7.3. Bootstrap-Discover Operation

The "Bootstrap-Discover" operation in the Bootstrap Interface is different from the "Discover" operation in the Device Management and Service Enablement interface.

The "Bootstrap-Discover" operation on the Bootstrap Interface is used to discover which LwM2M Objects and Object Instances are supported by a certain LwM2M Client. In particular, the list of LwM2M Security Object Instances (ID:0) is reported, while it is not accessible in Device Management and Service Enablement Interface. If OSCORE is supported on the client, a list of LwM2M OSCORE Objects (ID:21) is also reported, since this is not reported in Device Management and Service Enablement Interface either. If the MQTT Transport Binding is supported on the client, a list of LwM2M COSE Objects (ID:23) and MQTT Server Objects (ID:24) is also reported. This operation is useful to clean-up or to update a LwM2M Client configuration (e.g. adding (removing) a LwM2M Server Account to (from) the LwM2M Client configuration).

The returned payload is a list of application/link-format CoRE Links [RFC6690] containing the LwM2M Enabler Version and for each targeted Object - in addition to the Object Version, see Section [7.2. Object Versioning](#) and [Table: 7.3.1.-1 Class Attributes](#) - a sub-list of the Instances of such an Object Instance. In order to fully identify the Server Accounts supported by the Client, each element of the Instances list of the LwM2M Security Object (Object ID:0) includes the associated Short Server ID and LwM2M Server URI in its parameters list while the elements of the Instances list of the LwM2M Server Object (Object ID:1) also report the associated Short Server ID in their parameters list. If the LwM2M Client supports OSCORE and/or the MQTT Transport Binding, each element of the Instances list of the LwM2M OSCORE Object (Object ID:21), LwM2M COSE Objects (ID:23), and MQTT Server Objects (ID:24) includes the associated Short Server ID in its parameters list, except the Object Instances which are associated with the LwM2M Bootstrap-Server.

The Bootstrap-Server LwM2M Security Object Instance does not include a Short Server ID in its parameter list (none is defined); therefore the LwM2M Server URI for the Bootstrap Server can also be omitted in such a parameters list.

In "Bootstrap-Discover" operation the targeted path '/' is accepted in place of the Object ID, for informing the Client to report all existing Object Instances.

The "Bootstrap-Discover" operation has the following parameters:

Parameter	Required	Default Value	Notes
Object ID	No	-	Indicates the Object. (/ means all Objects)

Table: 6.1.7.3.-1 Bootstrap-Discover Parameters

For example:

- when the "Bootstrap-Discover" operation targets an Object with Object ID of 0 (LwM2M Security Object), the response to the operation could be:

```
</>;lwm2m=1.1,</o/0>;ssid=101;uri="coaps://server_1.example.com", </o/1/>,</o/2>;ssid=102;uri="coaps://server_2.example.com"
```

with the meaning three LwM2M Servers are supported in that Client (which support the LwM2M Enabler in version 1.1), while the Instance ID:1 of the LwM2M Security Object ID:0 contains the credentials for the LwM2M Bootstrap-Server.

- when the "Bootstrap-Discover" operation targets an Object with '/' the response to the operation could be:

```
</>;lwm2m=1.1,</o/0>;ssid=101;uri="coaps://server_1.example.com", </o/1>, </1/0/>;ssid=101, </3/0>,</5>,</4>
```

with the meaning the Client is supporting (in LwM2M version 1.1) a LwM2M Bootstrap-Server Account (/0/1), a LwM2M Server Account (/0/0, /1/0) with a Short Server ID=101, A Device Object Instance (/3/0) and two other Objects, which are not instantiated yet (Firmware Update /5, and Connectivity Monitor Object /4).

- when the "Bootstrap-Discover" addresses a LwM2M Client supporting the LwM2M Enabler in release 1.1, and containing a configuration with Objects with Object ID of 0 (LwM2M Security Object) and Object ID of 21 (LwM2M OSCORE Object):

```
</>;lwm2m=1.1,</o/0>;ssid=101;uri="coaps://server_1.example.com",</o/2>;ssid=102;uri="coap://server_1.example.com",</21/0>;ssid=101,</21/2>;ssid=102,</o/1>,</21/1/>
```

with the meaning two LwM2M Servers are supported in that Client (that supports the LwM2M Enabler in version 1.1), the Instance ID:0 of the LwM2M Security Object ID:0 and the Instance ID:0 of the LwM2M OSCORE Object ID:21 contains the DTLS and OSCORE credentials, respectively, of the LwM2M Server with ssid=101. The instance ID:2 of the LwM2M OSCORE Object ID:21 contains the OSCORE credentials of the LwM2M Server with ssid=102, which supports No\_Sec mode. The Instance ID:1 of the LwM2M OSCORE Object ID:21 contains the OSCORE credentials for the LwM2M Bootstrap-Server.

- when the "Bootstrap-Discover" addresses a LwM2M Client supporting the LwM2M Enabler in release 1.1, and containing a configuration with an hypothetical LwM2M Object ID:55 in Version 1.9, with one Instance (/55/0):

```
</>;lwm2m=1.1,</o/0>,</o/1>;ssid=101;uri="coaps://server_1.example.com", </1/0>;ssid=101, </3/0>,</5>,</4>,</55>;ver=1.9,</55/0>
```

- when the "Bootstrap-Discover" addresses a LwM2M Client supporting the LwM2M Enabler in release 1.2, and containing a configuration with Objects with Object ID of 0 (LwM2M Security Object), Object ID of 21 (LwM2M OSCORE Object), Object ID of 23 (LwM2M COSE Object), and Object ID of 24 (MQTT Server Object):

```
</>;lwm2m=1.2,</o/0>;ssid=101;uri="coaps://server_1.example.com", </o/1>,</21/0>;ssid=101,</24/1>,</23/65>
```

with the meaning one LwM2M Server is supported in that Client (that supports the LwM2M Enabler in version 1.2), the Instance ID:0 of the LwM2M Security Object ID:0 and the Instance ID:0 of the LwM2M OSCORE Object ID:21 contains the DTLS and OSCORE credentials, respectively, of the LwM2M Server with ssid=101. the Instance ID:1 of the LwM2M Security Object ID:0, the Instance ID:1 of the MQTT Server Object ID:24 and the Instance ID:65 of the LwM2M COSE Object ID:23 contain the TLS credentials, MQTT configuration, and COSE keying material, respectively, for the LwM2M Bootstrap-Server.

Note: In previous versions of this document, the LwM2M Enabler Version link parameter was not associated to any URI-Reference in the examples (e.g. "lwm2m=1.0,</o/0>;ssid=101,</o/1/>,</o/2>;ssid=102"). Thus, the provided examples were not in conformance with the ABNF of [RFC6690]. LwM2M Servers MAY accept this particular error in the LwM2M Client's response to the "Bootstrap-Discover" operation.

#### 6.1.7.4. Bootstrap-Read Operation

The "Bootstrap-Read" operation in the Bootstrap Interface is a restricted form of the "Read" operation found in the Device Management and Service Enablement interface, and MUST be limited to target Objects that are strictly necessary to setup a proper configuration in a LwM2M Client.

In this specification the only acceptable targets for the "Bootstrap-Read" operation is the LwM2M Server Object (Object ID: 1) and the Access Control Object (Object ID:2). This operation will allow the Bootstrap-Server to query the existing Server Account(s) to determine validity and to add new Server Account(s) without breaking the access control rights already in place in the targeted LwM2M Client.

The "Bootstrap-Read" operation is used to access a single Instance or all Instances of the Server Object (ID:1) and the Access Control Object (ID:2).

The "Bootstrap-Read" operation has the following parameters:

Parameter	Required	Default Value	Notes
Object ID	Yes	-	Indicates the Object. Object ID MUST be '1' (Server Object) or '2' (Access Control Object). An error is reported otherwise.
Object Instance ID	No	-	Indicates the Object Instance to be read. If no Object Instance ID is indicated, then all Instances of the targeted Object are returned.

Table: 6.1.7.4.-1 Bootstrap-Read Parameters

As a simple illustration based on the second example of Section [7.5.5.2. Multiple Object Instance Request Examples](#): the "Bootstrap-Read /2" operation with JSON requested format could provide the following answer:

```
{ "bn": "/2/", "n": "o/o", "v": 1},
  { "n": "o/1", "v": 0},
  { "n": "o/2/127", "v": 7},
  { "n": "o/3", "v": 127},
  { "n": "2/o", "v": 3},
  { "n": "2/1", "v": 0},
  { "n": "2/2/127", "v": 7},
  { "n": "2/2/310", "v": 7},
  { "n": "2/3", "v": 127}
```

Table: 6.1.7.4.-2 Bootstrap-Read Example with Multiple Object Instances

Any optional resources included in the "Bootstrap-Read" operation response that are not supported by, or unknown to, the LwM2M Bootstrap-Server MUST NOT be interpreted as an error by the LwM2M Bootstrap-Server.

### 6.1.7.5. Bootstrap-Write Operation

The "Bootstrap-Write" operation in Bootstrap Interface is different from the "Write" Operation in the Device Management and Service Enablement interface. The LwM2M Client MUST write the value included in the payload regardless of an existence of the targeted Object Instance(s) or Resource(s).

Any optional Resources included in the "Bootstrap-Write" operation targeting an Object or an Object Instance that are not supported by, or unknown to, the LwM2M Client MUST NOT be interpreted as an error by the LwM2M Client. If the LwM2M Client supports optional resources not present in the payload, it MUST NOT instantiate these optional resources.

If New Value does not contain values for all Resources (mandatory and optional) of the Object, the LwM2M Client MAY populate the missing Resources with implementation dependent default values.

The "Bootstrap-Write" operation can be sent multiple times.

Only in the Bootstrap Interface, the "Bootstrap-Write" MAY target just an Object ID, which will allow a Bootstrap-Server in using a TLV, LwM2M CBOR, SenML CBOR or SenML JSON formatted payload, to populate a LwM2M Client in a single message containing several Instances of the same Object.

The "Bootstrap-Write" operation has the following parameters:

Parameter	Required	Default Value	Notes
Object ID	Yes	-	Indicates the Object.
Object Instance ID	No	-	Indicates the Object Instance to write. If no Object Instance ID is indicated, Object Instance(s) MUST be specified in the TLV, LwM2M CBOR, SenML CBOR or SenML JSON payload.
Resource ID	No	-	Indicates the Resource to write. The payload is the new value for the Resource. If no Resource ID is indicated, then the value included payload is an Object Instance containing the Resource values.
New Value	Yes	-	The new value included in the payload to update the Object Instance(s) or Resource

Table: 6.1.7.5.-1 "Bootstrap-Write" Parameters

### 6.1.7.6. Bootstrap-Delete Operation

The "Bootstrap-Delete" operation targets one or several Object Instances and can be sent multiple times.

Only in the Bootstrap Interface, the "Bootstrap-Delete" operation MAY target any Instance or all Instances of any Object including the LwM2M Security Object (ID:0), supported by the LwM2M Client. The two exceptions are the LwM2M Bootstrap-Server Account, potentially including an associated Instance of a LwM2M OSCORE Object ID:21, an associated Instance of a LwM2M COSE Object ID:23, an associated Instance of a MQTT Server Object ID:24; and the single Instance of the mandatory Device Object (ID:3), which are not affected by any Delete operation.

When the "Bootstrap-Delete" operation is used without any parameter (i.e. without Object ID parameter), all Instances of all Objects in the LwM2M Client MUST be removed (except for the two cases mentioned above). This functionality could be used for initialization purposes before LwM2M Bootstrap-Server sends Write operation(s) to the LwM2M Client.

The "Bootstrap-Delete" operation has the following parameters:

Parameter	Required	Default Value	Notes
Object ID	No	-	Indicates the Object from which Object Instance will be deleted. If no Object ID is indicated, all existing Object Instances (except the LwM2M Bootstrap-Server Account, potentially including an associated Instance of an OSCORE Object, and the Instance of the Device Object) in the LwM2M Client will be deleted.
Object Instance ID	No	-	Indicates the Object Instance to delete. If no Object Instance ID is indicated, then all Instances of the designated Object (Object ID MUST be provided) are deleted.

Table: 6.1.7.6.-1 Bootstrap-Delete Parameters

### 6.1.7.7. Bootstrap-Pack-Request Operation

The "Bootstrap-Pack-Request" operation is only performed to initiate the Bootstrap Sequence in the "Client Initiated Bootstrap" mode by the client indicating that the client wants to retrieve a "Bootstrap-Pack".

"Bootstrap-Pack" contains, at minimum, the required bootstrap information defined in Section [6.1.2. Bootstrap Information](#). Only by using "Bootstrap-Pack" in the Bootstrap Interface, an LwM2M client can be populated in a single message containing several Objects and several Instances of such Objects.

In "Bootstrap-Pack-Request" operation, the Bootstrap Server receives a "Bootstrap-Pack-Request" and the Bootstrap Server responds with a "Bootstrap-Pack" which the client uses to create or replace objects on the client.

The LwM2M client MUST delete the existing Objects and their Instances in the client with the Objects and their Instances given in the "Bootstrap-Pack" if the Object IDs are the same. Object IDs available in the LwM2M Client which are not provided in the "Bootstrap-Pack" MUST NOT be deleted. The two exceptions are the LwM2M Bootstrap-Server Account, potentially including an associated Instance of an OSCORE Object ID:21, and the single Instance of the mandatory Device Object (ID:3), which are not affected by any Delete operation. Thus, when checking the configuration consistency, the LwM2M Client MUST ensure that the LwM2M Bootstrap-Server Account is still present.

The LwM2M Client MUST write the value included in the "Bootstrap-Pack" payload regardless of a previous existence of the targeted Object Instance(s) or Resource(s). Any optional Resources included in the "Bootstrap-Pack" targeting an Object or an Object Instance that are not supported by, or unknown to, the LwM2M Client MUST NOT be interpreted as an error by the LwM2M Client. If the LwM2M Client supports optional resources not present in the payload, it MUST NOT instantiate these optional resources.

If the LwM2M Bootstrap-Server does not support "Bootstrap-Pack-Request", it MUST return an error code indicating not implemented to the LwM2M Client when "Bootstrap-Pack-Request" is received. If the LwM2M Server supports the "Bootstrap-Pack-Request" but wishes the LwM2M Client not to use "Bootstrap-Pack" for bootstrapping, it MUST return an error code indicating that the method is not allowed to the LwM2M Client. After receiving an error in response to a "Bootstrap-Pack-Request", the LwM2M Client MUST use "Bootstrap-Request" operation to continue Client Initiated Bootstrap.

If the LwM2M Client does not receive any response from the LwM2M Bootstrap-Server during the EXCHANGE\_LIFETIME time period, the LwM2M Client MAY retry bootstrapping with "Bootstrap-Pack-Request".

The "Bootstrap-Pack-Request" operation has the following parameters:

Parameter	Required	Default Value	Notes
Endpoint Client Name	No	-	Indicates the LwM2M Client's "Endpoint Client Name". This parameter is optional if it is equal to the identifier in the security protocol and deployment is such that the security protocol identifier is always available for the server (e.g. no proxies in between).
LwM2M Bootstrap-Server Account Object Instances	No	-	Indicates the LwM2M Object Instances related to the LwM2M Bootstrap-Server Account in the CoRE Link format.

Table: 6.1.7.7.-1 Bootstrap-Pack-Request Parameters

LwM2M Bootstrap-Server Account Object Instances, if present, MUST be expressed in the CoRE Link Format defined in [RFC6690], so that each Object Instance is described as a Link according to that format. The Target component of the link is required, and consists of the Object Instance path. The link MUST NOT include any parameter.

For the LwM2M Client example defined in Section [Appendix F. Example LwM2M Client \(Informative\)](#), the LwM2M Bootstrap-Server Account Object Instances would be: `</0/0>`.

For another LwM2M Client where the LwM2M Bootstrap-Server Account is defined by the Instance 2 of the LwM2M Security Object and Instance 0 of the LwM2M OSCORE Object, the LwM2M Bootstrap-Server Account Object Instances would be: `</0/2>,</21/0>`.

As a simple illustration based on the LwM2M Client example defined in Section [Appendix F. Example LwM2M Client \(Informative\)](#), a Bootstrap-Pack could look like the following in SenML JSON encoded format below. For editorial purposes line breaks have been added to the example.

```

[{"n": "/0/1/", "o": "o", "vs": "coaps://server1.example.com"},
{"n": "1", "vb": false},
{"n": "2", "v": 0},
{"n": "3", "vd": "YjMxM2NmJltZjk2OSooMmVjLWFkNDI"},
{"n": "4", "vd": ""},
{"n": "5", "vd": "HKICjXGXx3jprvXvaQgr6g"},
{"n": "10", "v": 101},
{"bn": "/0/2/", "n": "o", "vs": "coaps://server2.example.com"},
{"n": "1", "vb": false},
{"n": "2", "v": 1},
{"n": "3", "vd": "MFkwEwYHkoZlZjoCAQYIKoZlZjoDAQcDQgAEoJ3LG8c55_Ga-prcsZRJaL-6c-_OwptQSG6oTRspwZNEmXCjc2gwyvV1-wForofwHtt9eSLVM53pqcindqRwg"},
{"n": "4", "vd": "MFkwEwYHkoZlZjoCAQYIKoZlZjoDAQcDQgAEgsdz83jTDCeDpl64Ebls9qkGikHwTx5_bTZhUvEWmJUPb3xAzaWFMo-Dd1ChAvW_JVCM655V38DxKkVRmaTJYA"},
{"n": "5", "vd": "MHcCAQEElJ81LaFklXSOFGLU3C46WopLO1Vz6j65VoIUz2fZFIg4oAoGCCqGSM49AwEHoUQDQgAEoJ3LG8c55_Ga-prcsZRJaL-6c-_OwptQSG6oTRspwZNEmXCjc2gwyvV1-wForofwHtt9eSLVM53pqcindqRwg"},
{"n": "10", "v": 102},
{"bn": "/1/0/", "n": "o", "v": 101},
{"n": "1", "v": 86400},
{"n": "2", "v": 300},
{"n": "3", "v": 6000},
{"n": "5", "v": 86400},
{"n": "6", "vb": true},
{"n": "7", "vs": "U"},
{"bn": "/1/1/", "n": "o", "v": 102},
{"n": "1", "v": 86400},
{"n": "2", "v": 60},
{"n": "3", "v": 6000},
{"n": "5", "v": 86400},
{"n": "6", "vb": false},
{"n": "7", "vs": "U"},
{"bn": "/2/0/", "n": "o", "v": 1},
{"n": "1", "v": 0},
{"n": "2/101", "v": 15},
{"n": "3", "v": 101},
{"bn": "/2/1/", "n": "o", "v": 1},
{"n": "1", "v": 1},
{"n": "2/102", "v": 15},
{"n": "3", "v": 102}
]

```

Table: 6.1.7.7.-2 Bootstrap-Pack Example with Multiple Objects and Multiple Object Instances

## 6.2. Client Registration Interface

The LwM2M Server MUST support all operations in this interface. The LwM2M Client MUST support the "Register" and the "Update" operations. The LwM2M Client SHOULD support the "De-register" operation.

The Client Registration Interface is used by a LwM2M Client to register with one or more LwM2M Servers, maintain each registration, and de-register from a LwM2M Server. The registration is based on the Resource Model and Identifiers defined in Section 7 [Identifiers and Resources](#). When registering, the LwM2M Client performs the "Register" operation and provides the information required by the LwM2M Server (e.g. the supported Objects and existing Object Instances) as well as optional parameters (e.g. Endpoint Client Name). The LwM2M Client and the LwM2M Server maintain the LwM2M Registration Session based upon the configured parameters (e.g. Lifetime, security context). The ability to maintain an LwM2M Registration Session may be impacted by a change in the Transport Session, e.g. a binding change.

The LwM2M Client periodically performs an update of its registration information to the registered LwM2M Server(s) by performing the "Update" operation.

If the lifetime of a registration expires without receiving an update from the LwM2M Client, the LwM2M Server will consider it a de-registration:

- The LwM2M Server MUST remove the registration of that LwM2M Client and existing observations. If the LwM2M Client is unaware of the expiration, when the LwM2M Client performs a registration update the LwM2M Server will respond with an error.
- Upon receipt of the error message, the LwM2M Client SHOULD reset its state and register again. The LwM2M Client

MUST re-register ("Update" is not sufficient) to the LwM2M Server in order to be connected again, before initiating any further communication.

If the LwM2M Server or the LwM2M Client sets a value to the Lifetime Resource of the Server Object Instance, this value becomes the new lifetime of the Registration.

During "Register" or "Update" operations, the parameter Lifetime – if present – MUST match the current value of the Mandatory Lifetime Resource of the LwM2M Server Object Instance.

Finally, when shutting down or discontinuing use of a LwM2M Server, the LwM2M Client SHOULD perform a "De-register" operation.

The Binding Resource of the LwM2M Server Object informs the LwM2M Client about the transport protocol preferences of the LwM2M Server for the Transport Session between the LwM2M Client and LwM2M Server. The LwM2M Client SHOULD perform the operations with the modes indicated by the Binding Resource of the LwM2M Server Object Instance.

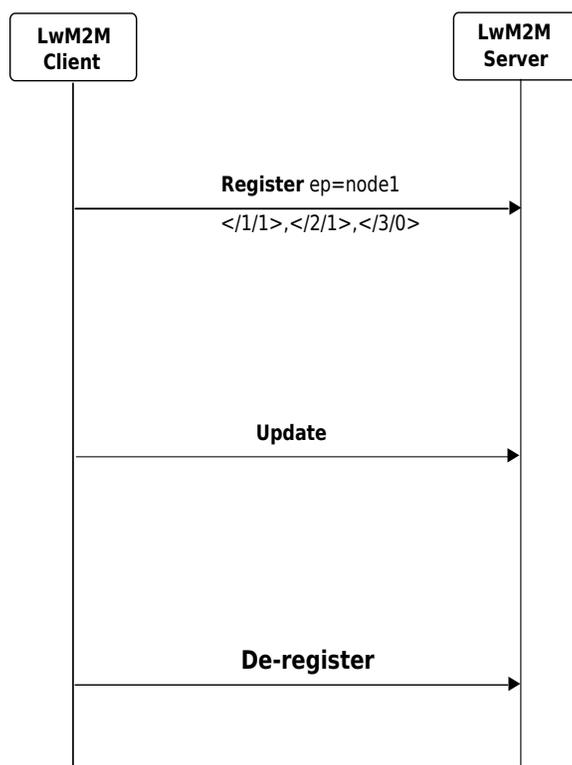

Figure: 6.2.-1 Client Registration Interface example flows

The mapping to underlying transports is detailed in [LwM2M-TRANSPORT].

### 6.2.1. Register Operation

Registration is performed when a LwM2M Client sends a "Register" operation to the LwM2M Server. After the LwM2M Device is turned on and the bootstrap procedure has been completed, the LwM2M Client MUST perform a "Register" operation to each LwM2M Server that the LwM2M Client has a Server Object Instance. [Table: 6.2.1.-1 Registration Parameters](#) describes the parameters used for the "Register" operation.

The "Register" operation SHOULD include the Endpoint Client Name parameter along with other parameters listed in [Table: 6.2.1.-1 Registration Parameters](#). When the Endpoint Client Name parameter is provided in the "Register" operation then it MUST contain a value for the Endpoint Client Name parameter that is unique on that LwM2M Server.

Upon receiving a "Register" operation from the LwM2M Client, the LwM2M Server records the connection information

of the registration message (e.g. source IP address and port or MSISDN) and uses this information for all future interactions with that LwM2M Client.

If the LwM2M Client sends a "Register" operation to the LwM2M Server, even though the LwM2M Server has registration information of the LwM2M Client, the LwM2M Server removes the existing registration information and performs the new "Register" operation. This situation happens when the LwM2M Client forgets the state of the LwM2M Server (e.g. factory reset).

The LwM2M Server MUST support all the parameters and payloads listed at [Table: 6.2.1.-1 Registration Parameters](#), except for the Profile ID. The LwM2M Client MUST implement LwM2M Version, Lifetime, Object and Object Instances and MAY implement all other parameters.

Parameter	Required	Default Value	Notes
Endpoint Client Name	No		See Section <a href="#">7.4. Identifiers</a>
Lifetime	Yes		Indicates the expected lifetime of the registration for this LwM2M client. This value MUST be the same as the value held in the Resource named "Lifetime" of the corresponding instance of Server Object (ID \#1): /1/x/1.
LwM2M Version	Yes		Indicates the version of the LwM2M Enabler that the LwM2M Client supports. The LwM2M version number reported MUST correspond to the approved version number of this document.
Binding Mode	No	U	Indicates the supported binding modes in the LwM2M Client. This value SHOULD be the same as the value in the "Supported Binding and Modes" resource in the Device Object (/3/0/16). The valid values of the parameter are listed in Section <a href="#">6.2.1.2. Behaviour with Current Transport Binding and Modes</a>
Queue Mode	No		Indicates whether Queue Mode is supported. The Queue Mode is useful when the LwM2M Device is not reachable by the LwM2M Server at all times and it helps the LwM2M Client to reduce power consumption by sleeping longer.
SMS Number	No		The value of this parameter is the MSISDN or External Identifier where the LwM2M Client can be reached for use with the SMS binding or when both the LwM2M Client and the LwM2M Server support the SMS registration update trigger mechanism defined in [LwM2M-TRANSPORT].
Objects and Object Instances	No		A list of Objects supported and Object Instances available on the LwM2M Client (LwM2M Security Object ID:0, LwM2M OSCORE Object ID:21, and LwM2M COSE Object ID:23, if present, MUST NOT be part of this list).
Profile ID	No		The Profile ID parameter represents a list of Objects supported and Object Instances available on the LwM2M Client (LwM2M Security Object ID:0, LwM2M OSCORE Object ID:21, and LwM2M COSE Object ID:23, if present, MUST NOT be part of this list) by reference rather than by value. Multiple Profile IDs MAY be included. The Profile ID argument value MUST be encoded as an ASCII string following the ABNF below.

Table: 6.2.1.-1 Registration Parameters

The syntax of the "Profile ID" argument value is as follows:

```
value = profileID / ( "" profileID *( "," profileID ) "" )
profileID = dynamicID / preConfigID
dynamicID = suite-identifier ":" 1*(ahlc)
suite-identifier = 1*( DIGIT )
ahlc = DIGIT / "a" / "b" / "c" / "d" / "e" / "f"
preConfigID = ("oma" / "v") ":" 1*(ALPHA / DIGIT / "-")
```

The Profile ID can be used in two different deployment modes, namely

- In the pre-configured mode, the identifier used in the Profile ID refers to a list of Objects supported and Object Instances available on the LwM2M Client (LwM2M Security Object ID:0, LwM2M OSCORE Object ID:21, and LwM2M COSE Object ID:23, if present, MUST NOT be part of this list). The value is either registered with the Open Mobile Naming Authority (OMNA) or a vendor-specific value. The value needs to be pre-configured on the LwM2M Client and on the LwM2M Server so that both communication peers understand how to map the Profile ID value to the list of Objects and Object Instances it represents.

- In the dynamically generated mode the LwM2M Client itself creates a fingerprint (in form of a cryptographic hash) of a list of Objects supported, the object versions and Object Instances available on the LwM2M Client (LwM2M Security Object ID:0, LwM2M OSCORE Object ID:21, and LwM2M COSE Object ID:23, if present, MUST NOT be part of this list) it wants to convey with the register operation to the LwM2M Server. Object versions MUST always be included in the finger print calculation even for version 1.0 of objects as well as those that can be inferred from the LwM2M protocol version. The LwM2M Client then puts this fingerprint value into the Profile ID parameter. To avoid collisions, the selected hash algorithm needs to be sufficiently long, i.e. 32 bits and longer.

If the LwM2M Server cannot retrieve the list of Objects and Object Instances based on the received Profile ID value, it MUST reply to the registration message with an error code. The LwM2M Client MUST then perform the register operation with a registration message that MUST include the list of Objects supported and Object Instances available on the LwM2M Client.

Using the dynamically generated mode the LwM2M Server may be able to determine the mappings between the Profile ID value and its corresponding list of Objects and Object Instances.

An LwM2M Client MAY include multiple Profile ID parameters in a single message and MAY mix the Profile ID parameter with a list of Objects and Object Instances in the payload of the message. The latter allows the LwM2M Client to use the Profile ID for a commonly used combination of Objects and Object Instances while offering the possibility to include rarely used configurations in the payload.

The LwM2M Server uses all provided Profile ID values and the provided Objects and Object Instances to determine the list of supported Objects and Object Instances of the LwM2M Client. If no information is provided in the registration request the LwM2M Server MAY determine the list of supported Objects and Object Instances of the LwM2M Client through pre-configuration, which is outside the scope of this specification. If the LwM2M Server cannot determine the list of Objects and Object Instances it MUST reply to the registration message with an error code.

The value used in the Profile ID follows a naming convention:

- For hashes this specification uses the numerical ID value of IANA registered Named Information Hash Algorithms defined by [RFC6920] to indicate the hash algorithms used. For example, the use of SHA256 truncated to 32 bits is indicated by the profile ID value "6:1234abcd".
- For values used in application domains registered via the OMNA, the prefix is "oma:" followed by the registered value. The list of standardized values can be found at [OMNA].
- For values used in vendor-specific deployments, the prefix "v:" followed by the value is used.

An LwM2M Server MUST refuse a Client's Registration request, if it does not support the LwM2M Enabler version indicated by the Client.

An LwM2M Server MAY refuse to use the Profile ID by returning an error requiring the LwM2M to indicate the list of Objects and Object Instances in a subsequent registration message.

When an Object defined outside of an LwM2M Enabler has to be registered by the Client, but is not supported by the Server (unknown Object or unsupported Object version) it MUST NOT be interpreted as an error by the Server and will not prevent the Client's Registration request to be accepted.

The Media-Type of the registration message, if used, MUST be the CoRE Link Format (application/link-format) defined in [RFC6690], so that each Object is described as a Link according to that format. The Target component of the link is required, and consists of the Object path and Object Version CoRE link parameter "ver" if required as it is defined in Section [7.2. Object Versioning](#) of this document. Any other parameters included in the link MUST NOT be interpreted as an error, unless specified for use by the LwM2M Enabler.

As an example, the payload for a LwM2M Client supporting LwM2M Server, Access Control, Device, Connectivity Monitoring and Firmware Update Objects from Section [Appendix E. LwM2M Objects defined by OMA \(Normative\)](#) would be (for the example client of Section [Appendix F. Example LwM2M Client \(Informative\)](#)):

```
</1/0>,</1/1>,</2/0>,</2/1>,</2/2>,</2/3>,</2/4>,</3/0>,</4/0>,</5>
```

If the LwM2M Client supports optional data formats, it MAY inform the LwM2M Server by including the content types in the root path link using the ct= link attribute defined in [CoAP]. An example is as follows (note that the content type value 110 is the value assigned in the CoAP Content-Format Registry for the SenML JSON format used by LwM2M).

```
</>ct=110, </1/0>, </1/1>, </2/0>, </2/1>, </2/2>, </2/3>, </2/4>, </3/0>, </4/0>, </5>
```

Another example if the LwM2M Client supports the SenML JSON format, the CBOR format, and the SenML CBOR format:

```
</>ct="110 112 60", </1/0>, </1/1>, </2/0>, </2/1>, </2/2>, </2/3>, </2/4>, </3/0>, </4/0>, </5>
```

### *6.2.1.1. Bootstrap and LwM2M Server Registration Mechanisms*

In order to provide robust mechanisms for LwM2M Server registrations, resources have been defined in the LwM2M Server Object to configure the order of LwM2M Server registrations, registration retry behavior and the ability for the LwM2M Client to react during registration failure conditions. These resources are optional, so the behavior is only enabled when these resources are defined. If these resources are not defined, default values in [Table: 6.2.1.1.-1 Registration Procedures Default Values](#) or a manufacturer defined implementation may be used.

The first step is for the LwM2M Client to determine the registration order when multiple LwM2M Servers are defined (i.e. multiple instances of LwM2M Server Objects). The LwM2M Client orders the LwM2M Server registrations in ascending order of the "Registration Priority Order" value. It is recommended that each ordered LwM2M Server has a unique priority, so it is implementation dependent how to order those LwM2M Servers with the same priority. If this value is not defined for a LwM2M Server, registration attempts to that LwM2M Server are managed independently and do not impact other LwM2M Server registrations.

For each LwM2M Server that is defined in the registration order, the "Registration Failure Block" resource indicates the behavior of the LwM2M Client upon registration failure to that LwM2M Server. When the "Registration Failure Block" value is set to true and registration to the LwM2M server fails, the LwM2M Client performs additional registration retry sequences and blocks registration to other LwM2M Servers in the priority order. When the "Registration Failure Block" value is set to false, the LwM2M Client proceeds with registration to the next LwM2M Server in the priority order whether the current LwM2M Server is successfully registered or not.

The procedure to manage the registration to LwM2M Servers that have a "Registration Priority Order" resource included is defined here:

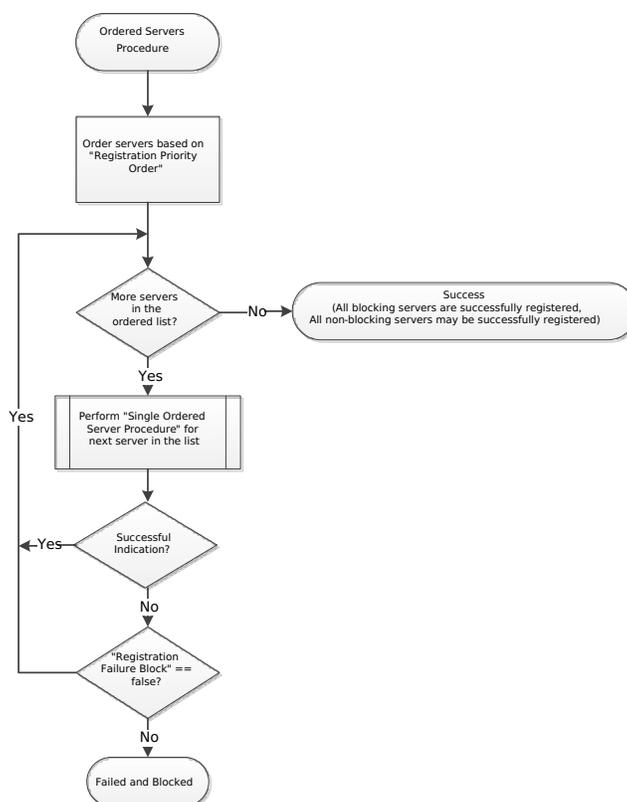

Figure: 6.2.1.1.-1 Ordered Servers Procedure

When registration fails to non-blocking LwM2M Servers in the "Ordered Servers Procedure", it is outside the scope of this specification how the LwM2M Client retries registration with those LwM2M Servers. One solution could be to execute the "Single Unordered Servers Procedure" for all failed non-blocking LwM2M Servers.

The "Communication Retry Count", "Communication Retry Timer", "Communication Sequence Delay Timer" and "Communication Sequence Retry Count" resources indicate to the LwM2M Client the retry mechanism to be used for registration attempts to a single LwM2M Server. The registration mechanism to a LwM2M Server consists of a sequence of "Communication Retry Count" attempts within a retry sequence. The "Communication Retry Timer" value is multiplied by two to the power of the current attempt minus one ( $2^{(\text{Current Attempt}-1)}$ ) to create an exponential back-off between attempts within a single retry sequence to a LwM2M Server. If one retry sequence of attempts to a LwM2M Server fails, then a new sequence of attempts may be retried after "Communication Sequence Delay Timer." The maximum number of retry sequences to a LwM2M Server is set by the "Communication Sequence Retry Count."

How these values are applied to those LwM2M Servers that are part of the ordered registration is defined in the "Single Ordered Server Procedure" here:

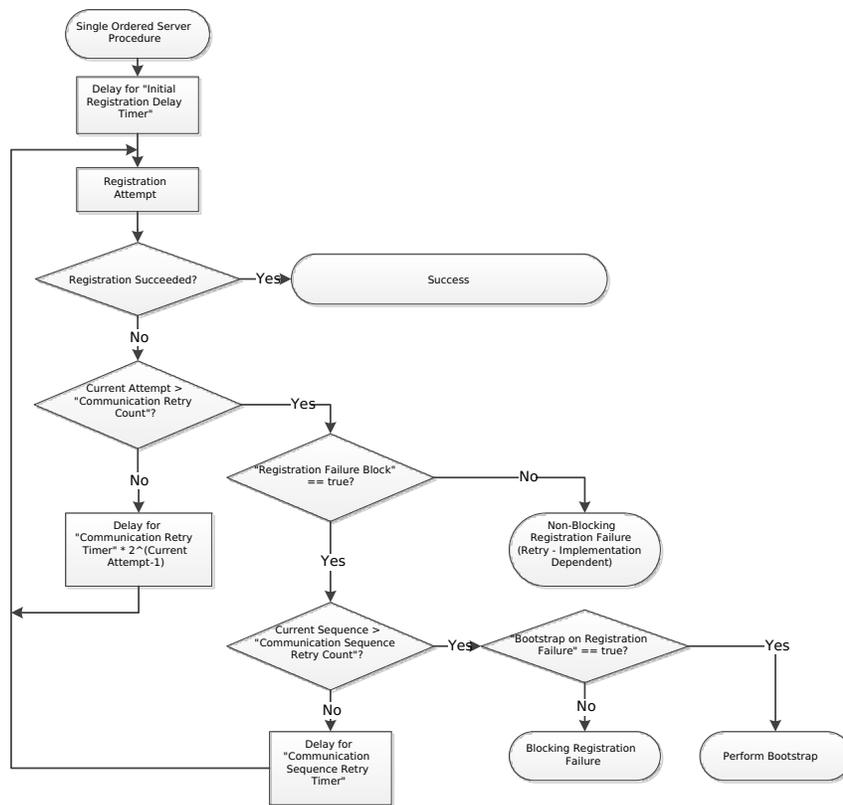

Figure: 6.2.1.1. -2 Single Ordered Server Procedure

How these values are applied to those LwM2M Servers that are NOT part of the ordered registration is defined in the "Single Unordered Server Procedure" here:

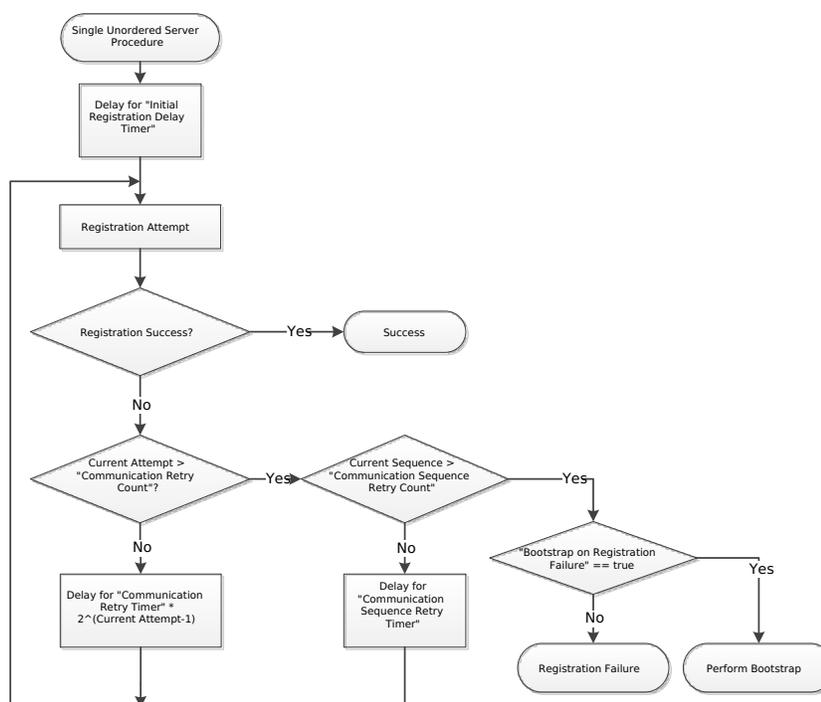

Figure: 6.2.1.1.-3 Single Unordered Server Procedure

Note: Current Attempt and Current Sequence start at 1 to represent the first attempt or sequence in the "Single Ordered Server Procedure" and "Single Unordered Server Procedure". These values should be reset to 1 at the start of each sequence and between sequences.

The "Initial Registration Delay Timer" defines the delay before the single registration procedure (ordered or unordered) is attempted for a LwM2M Server.

The "Bootstrap on Registration Failure" resource indicates to the LwM2M Client whether to re-bootstrap in case of a registration failure to the LwM2M Server. The exact behavior in case of bootstrap registration success, triggered by a server registration failure, is implementation dependent. For example, already successful LwM2M Server registrations may be maintained.

Note: It is recommended to set the "Bootstrap on Registration Failure" resource to true only when "Registration Failure Block" is set to true for any ordered LwM2M Server (i.e. that LwM2M Server is critical) to avoid a situation where the device has no recovery method. On the other hand, if the "Bootstrap on Registration Failure" resource is set to false, it is recommended to set the "Registration Failure Block" resource to false for an ordered LwM2M Server."

Note: It is recommended to set the "Communication Sequence Retry Timer" resource sufficiently large to accommodate for an entire registration attempt sequence to avoid an immediate retry sequence.

The registration retry mechanisms for the Bootstrap Server are implementation dependent.

The following table represents the recommended default values to use when the resources are not defined in the LwM2M Server Object:

Resource	Default Value
Registration Priority Order	Not defined
Registration Failure Block	False
Initial Registration Delay Timer	0 (seconds)
Bootstrap on Registration Failure	True
Communication Retry Count	5
Communication Retry Timer	1 (minute)
Communication Sequence Delay Timer	24 (hours)
Communication Sequence Retry Count	1

Table: 6.2.1.1.-1 Registration Procedures Default Values

### 6.2.1.2. Behaviour with Current Transport Binding and Modes

Behaviour of the LwM2M Server and the LwM2M Client is differentiated by Current Transport Binding and Modes. Current Transport Bindings are decided by "Binding" Resource set by the LwM2M Server. The "Binding" resource contains a combination of supported transports, for example UDP and TCP.

[Table: 6.2.1.2.-1 Behaviour with Current Transport Bindings](#) describes the behaviour of the LwM2M Server and the LwM2M Client for each Current Transport Bindings.

Current Transport Bindings	Behaviour
U (UDP)	<p>The LwM2M Server expects that the LwM2M Client is reachable via the UDP binding at any time.</p> <p>The LwM2M Server MUST send requests to a LwM2M Client using the UDP binding. The LwM2M Client MUST send the response to such a request over the UDP binding.</p> <p>This is the normal default mode of operation.</p>
M (MQTT)	<p>The LwM2M Server expects that the LwM2M Client is reachable via the MQTT binding at any time.</p> <p>The LwM2M Server MUST send requests to a LwM2M Client using the MQTT binding. The LwM2M Client MUST send the response to such a request over the MQTT binding.</p>
H (HTTP)	<p>The LwM2M Server expects that the LwM2M Client is reachable via the HTTP binding at any time.</p> <p>The LwM2M Server MUST send requests to a LwM2M Client using the HTTP binding. The LwM2M Client MUST send the response to such a request over the HTTP binding.</p>
T (TCP)	<p>The LwM2M Server expects that the LwM2M Client is reachable via the TCP binding at any time.</p> <p>The LwM2M Server MUST send requests to a LwM2M Client using the TCP binding. The LwM2M Client MUST send the response to such a request over the TCP binding.</p>
S (SMS)	<p>The LwM2M Server expects that the LwM2M Client is reachable via the SMS binding at any time.</p> <p>The LwM2M Server MUST send requests to a LwM2M Client using the SMS binding. The LwM2M Client MUST send the response to such a request over the SMS binding.</p>

N (Non-IP)	<p>Non-IP is defined in accordance with \[3GPP 23.401\] and is applicable for both NB-IoT and LTE M networks. Appendix C in \[LwM2M-TRANSPORT\]: LwM2M over 3GPP LPWA Networks - NB-IoT and LTE M, describes in detail the alternate routes for delivering non-IP data. Non-IP can also refer to alternate transports such as LoRaWAN</p> <p>The LwM2M Server MUST send requests to a LwM2M Client using the Non-IP binding. The LwM2M Client MUST send the response to such a request over the Non-IP binding.</p>
------------	---

Table: 6.2.1.2.-1 Behaviour with Current Transport Bindings

- While multiple transports are supported, only one transport binding can be used during the entire Transport Session. As an example, when UDP and SMS are both supported, the LwM2M Client and the LwM2M Server can choose to communicate either over UDP or SMS during the entire Transport Session.
- "Preferred Transport" is an optional resource in the LwM2M Server Object (/1/x/22). If this resource is defined, the LwM2M Client SHALL use this to initiate a connection over the specified transport, unless unable to do so. If this resource is not defined, the LwM2M Client SHALL use a client-preferred binding supported by both the LwM2M Server (from the list in the "binding" resource of the LwM2M Server Object - /1/x/7) and LwM2M Client (from the list in "Supported Binding and Modes" resource in the Device object - /3/x/16). The "Preferred Transport" resource can also be used to select a required transport. For example, when Non-IP is normally indicated as preferred, this resource can be set to UDP temporarily to perform a firmware update.
- "Registration Update Trigger" is a mandatory resource in the LwM2M Server Object (/1/x/8). The client SHALL use the argument when the "Registration Update Trigger" resource is executed unless not supported by the client or not indicated as supported by the server in the "binding" resource of the LwM2M Server Object (/1/x/7). When that argument indicates an overriding binding that is supported by the client, the client SHALL immediately release the existing transport connection and establish a new transport connection using the overriding binding if that overriding binding is different than the current transport connection.
- UDP SHALL be supported by the Server for binding and support for TCP is Optional. Clients SHALL assume UDP binding is supported by the Server even if the Server does not include UDP ("U") in the "binding" resource of the LwM2M server object (/1/x/7).
- When the APN Connection Profile object is defined with a "PDN Type" resource (/11/x/24), that "PDN Type" SHALL be preferred when present in the "binding" resource of the LwM2M server object (/1/x/7).
- When configurations related to the bindings change, those new values SHALL NOT affect the current Transport Session, and the new values SHALL be applied to the future Transport Sessions. The existing LwM2M client registration SHALL NOT be affected by the use of updated bindings configuration.
- Queue Mode and device triggering can be enabled independently, and can be used in conjunction with one or more transports. Using the device triggering, the LwM2M Server MAY request the LwM2M Client to perform operations, such as the "Update" operation by sending an "Execute" to the "Registration Update Trigger" Resource via SMS. An LwM2M Client is not expected to send an SMS response for a device trigger message.

## 6.2.2. Update Operation

Periodically or based on certain events within the LwM2M Client or initiated by the LwM2M Server, the LwM2M Client updates its registration information with a LwM2M Server by sending an "Update" operation to the LwM2M Server.

The "Update" operation can be initiated by the LwM2M Server via an "Execute" operation on the "Registration Update Trigger" Resource of the LwM2M Server Object. The LwM2M Client can perform an "Update" operation to refresh the lifetime of its registration to a LwM2M Server.

When any of the parameters listed in [Table: 6.2.2.-1 Update Parameters](#) changes, the LwM2M Client MUST send an "Update" operation to the LwM2M Server. This "Update" operation MUST contain only the parameters listed in [Table: 6.2.2.-1 Update Parameters](#) which have changed compared to the last registration parameters sent to the LwM2M Server.

Parameter	Required
Lifetime	No
Binding Mode	No
SMS Number	No
Objects and Object Instances	No
Profile ID	No

Table: 6.2.2.-1 Update Parameters

When present, the Objects and Object Instance list and/or the Profile ID MUST follow the same rules as in the Register operation.

The payload Media-Type of that "Update" operation is the same as the one of the "Registration" operation.

When an Object defined outside of an LwM2M Enabler is part of the LwM2M Client update registration list, but is not supported by the LwM2M Server (unknown Object or unsupported Object version), it MUST NOT be interpreted as an error by this LwM2M Server and will not prevent the LwM2M Client's "Update" operation to be accepted.

Two common operations are:

1. Extending the lifetime of a registration

In this case the LwM2M Client sends an "Update" operation with no parameters.

[Figure: 6.2.2.-1 Update Example Flow #1](#) shows an example exchange where the LwM2M Client sends an "Update" operation that only refreshes the registration, i.e. the message does not contain any parameters. With the second "Update" the Client changes the lifetime field to 6000 (seconds) and hence the It parameter is included in the message.

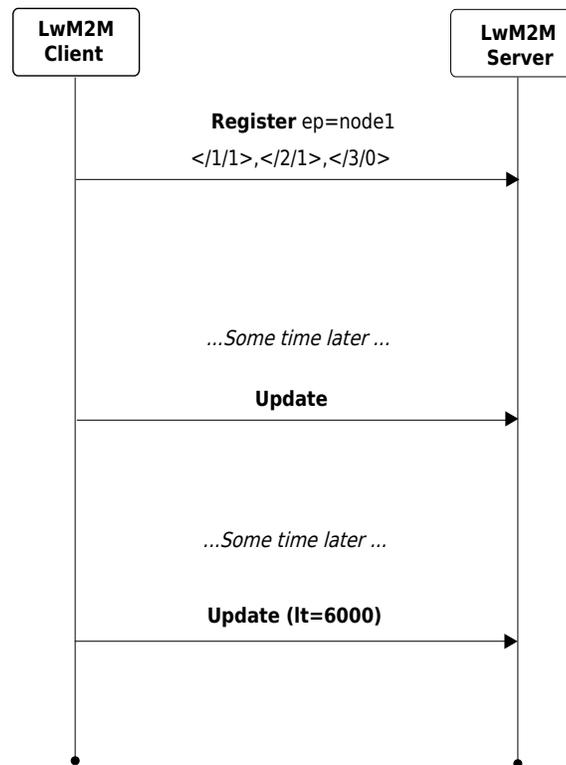

Figure: 6.2.2.-1 Update Example Flow #1

## 2. Adding and removing Objects and Object Instances

In this case the LwM2M Client sends an "Update" with a body listing the complete list of objects and object instances.

[Figure: 6.2.2.-2 Update Example Flow #2](#) shows an example exchange whereby the LwM2M Client starts with an initial registration of two instances for an LwM2M Object with ID 12. Later, the LwM2M Server adds a third instance and subsequently deletes the second. With the "Update" operation the LwM2M Client includes the new list of Objects and Object Instances.

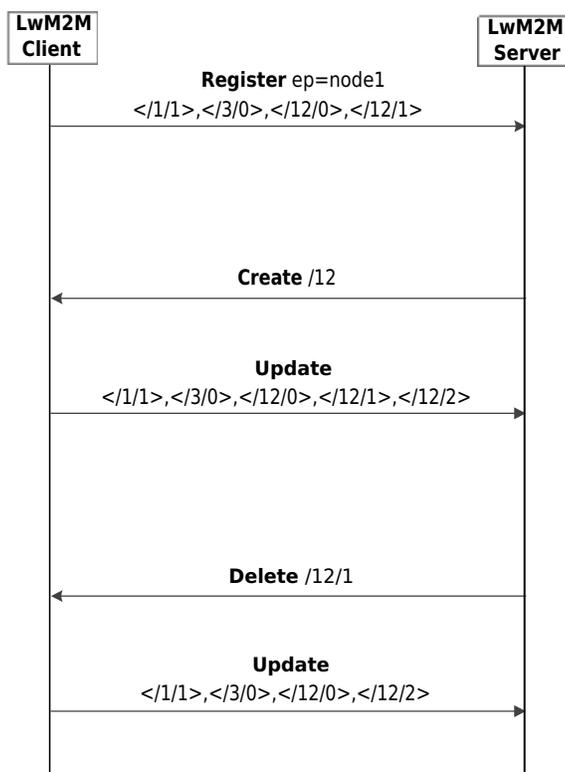

Figure: 6.2.2.-2 Update Example Flow #2

### 6.2.3. De-register Operation

When a LwM2M Client determines that it no longer requires to be available to a LwM2M Server (e.g. LwM2M Device factory reset), the LwM2M Client SHOULD send a "De-register" operation to the LwM2M Server. Upon receiving this message, the LwM2M Server removes the registration information from the LwM2M Server.

## 6.3. Device Management and Service Enablement Interface

The LwM2M Server and the LwM2M Client MUST support all the operations on this interface unless clearly stated otherwise. Support for some of the non-mandatory operations may also be dependent on the choice of transport layer and the services it provides.

The Device Management and Service Enablement Interface is used by the LwM2M Server to access Object Instances and Resources available from a registered LwM2M Client. The interface provides this access through the use of "Create", "Read", "Read-Composite", "Write", "Write-Composite", "Delete", "Execute", "Write-Attributes", or "Discover" operations. The operations that a Resource supports are defined in the Object definition using the Object Template. The Object Template is described in Section [Appendix D. LwM2M Object Template and Guidelines \(Normative\)](#). The Normative Objects defined by the LwM2M Enabler are described in Section [Appendix E. LwM2M Objects defined by OMA \(Normative\)](#).

The LwM2M Client MUST ignore LwM2M Server operations on this interface until the registration procedure with the respective LwM2M Server is completed.

The LwM2M Client MUST reject any LwM2M Server operation on the LwM2M Security Object (ID: 0) with a response code indicating that the operation is not authorized.

The LwM2M Client MUST reject any LwM2M Server operation on the LwM2M OSCORE Object (ID: 21) with a response code indicating that the operation is not authorized.

The LwM2M Client MUST reject any LwM2M Server operation on the LwM2M COSE Object (ID: 23) with a response code indicating that the operation is not authorized.

The LwM2M Server SHOULD NOT perform any operation on this interface before replying to the registration request of this LwM2M Client.

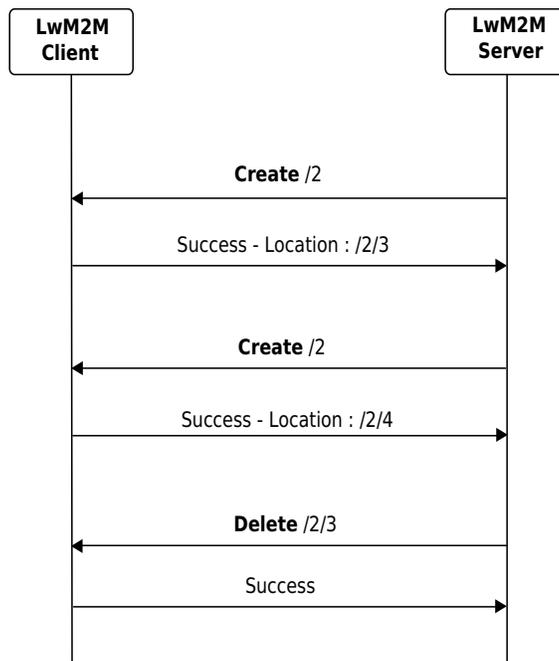
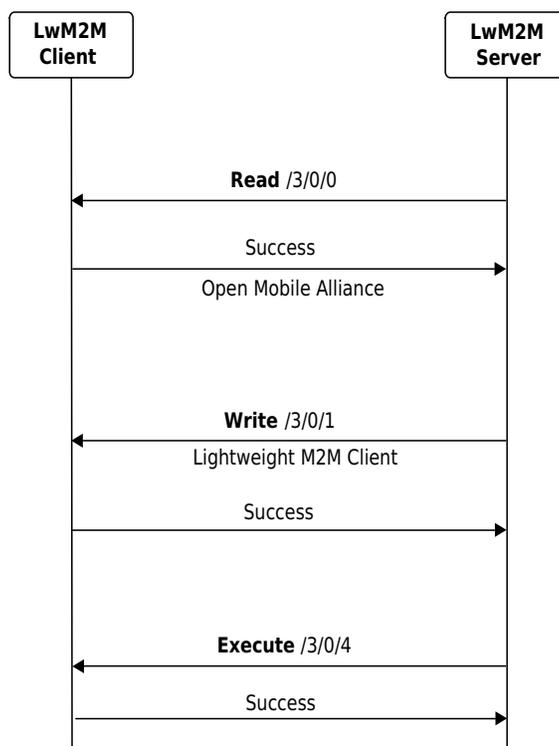

Figure: 6.3.-1 Example flows of Device Management & Service Enablement Interface

The mapping to underlying transports is detailed in [LwM2M-TRANSPORT].

### 6.3.1. Read Operation

The "Read" operation is used to access the value of a Resource, a Resource Instance, an array of Resource Instances, an Object Instance or all the Object Instances of an Object. The "Read" operation has the following parameters:

Parameter	Required	Default Value	Notes
Object ID	Yes	–	Indicates the Object.
Object Instance ID	No	–	Indicates the Object Instance to read. If no Object Instance ID is indicated, then Resource ID and Resource Instance ID MUST NOT be indicated otherwise an error is returned by the Client; if no error, the authorized Instances of the Object are returned to the Server
Resource ID	No	–	Indicates the Resource to read. If the final target is not a Resource Instance (see below), then the Resource value is returned. If no Resource ID is indicated, then the Resource Instance ID MUST NOT be indicated as well, and the whole Object Instance is returned
Resource Instance ID	No	–	Indicates the Resource Instance to read. An error MUST be returned by the Client, if the Resource ID is absent or if the targeted Resource is not defined as a Multiple-Instance Resource.

Table: 6.3.1.-1 Read Parameters

If the Resource ID is specified and if the requested Resource does not support the "Read" operation, the LwM2M Client MUST return an error code indicating that the method is not allowed to the LwM2M Server.

If the Resource ID is not specified, the LwM2M Client MUST retrieve all the requested Resources except the Resource(s) which does not support the "Read" operation and send the retrieved Resource(s) information to the LwM2M Server.

Any optional Resources included in the "Read" operation response that are not supported by, or unknown to, the LwM2M Server MUST NOT be interpreted as an error by the LwM2M Server.

### 6.3.2. Discover Operation

The "Discover" operation is used to discover LwM2M Attributes attached to or inherited by an Object, Object Instances, and Resources. This operation can be used to discover which Resources are instantiated in a given Object Instance. The returned payload is a list of application/link-format CoRE Links [RFC6690] for each targeted Object, Object Instance, or Resource, along with their attached or inherited Attributes including the Object Version attribute if required (see Section [7.2. Object Versioning](#) and [Table: 7.3.1.-1 Class Attributes](#)).

The "Discover" operation has the following parameters:

Parameter	Required	Default Value	Notes
Object ID	Yes	–	Indicates the Object.
Object Instance ID	No	–	Indicates the Object Instance.
Resource ID	No	–	Indicates the Resource.
Depth	No	2 if only Object ID is specified. 1 otherwise.	Indicates the depth of the returned list of links relative to the targeted URI. Possible values are 0..3

Table: 6.3.2.-1 Discover Parameters

The LwM2M Client SHOULD support the "Depth" parameter. If the LwM2M Client does not support the "Depth" parameter, it MUST ignore it and use the default value from [Table: 6.3.2.-2 Depth Modifier](#).

The LwM2M Client MUST respond to the "Discover" operation with the list of Object, Object Instances, Resources, and Resource Instances instantiated under the targeted Object according to [Table: 6.3.2.-2 Depth Modifier](#), with their

respective attached Attributes.

Specified Parameters	Depth 0	Depth 1	Depth 2	Depth 3	Default
Object ID	Object	Object and Object Instances	Object, Object Instances, and Resources	Object, Object Instances, Resources, and Resource Instances	Object, Object Instances, and Resources
Object ID, Object Instance ID	Object Instance	Object Instance and Resources	Object Instance, Resources, and Resource Instances	Object Instance, Resources, and Resource Instances	Object Instance and Resources
Object ID, Object Instance ID, Resource ID	Resource	Resource and Resource Instances	Resource and Resource Instances	Resource and Resource Instances	Resource and Resource Instances

Table: 6.3.2.-2 Depth Modifier

If a Resource, an Object Instance, or an Object have attributes for multiple LwM2M Servers, then the Attributes returned in the link, MUST only be related to the LwM2M Server which performed the "Discover" operation.

In addition, the list of Attributes attached to or inherited by the targeted Object, Object Instance, or Resource MUST be returned (see Section [Attributes Classification](#)). If a Resource Instance, a Resource, an Object Instance, or an Object have attributes for multiple LwM2M Servers, then the Attributes returned in the link, MUST only be related to the LwM2M Server which performed the "Discover" operation.

For example:

- when the "Discover" operation targets an Object with Object ID of 3, the response to the operation could be:

```
</3>;pmin=10, </3/0>;pmax=60, </3/0/1>, </3/0/2>, </3/0/3>, </3/0/4>, </3/0/6>;dim=2, </3/0/7>;dim=2;gt=50;lt=42.2, </3/0/8>;dim=2, </3/0/11>, </3/0/16>
```

which means that the LwM2M Client supports the Device Object (Instance 0) Resources with IDs 1, 2, 3, 4, 6, 7, 8, 11, and 16 among the Resources of Device Info Object. A Maximum Period Attribute has been attached to the Object and a Minimum Period Attribute has been attached to the Object Instance. The Resources 7 and 8 both have two Resource Instances. A Greater Than and a Less Than Attributes has been attached to Resource 7.

- when the "Discover" operation targets an Object with Object ID of 1 and a Depth of 1, the response to the operation could be:

```
</1>, </1/0>, </1/4>;pmax=300
```

which means that the LwM2M Client has two Object Instances of the Server Object with IDs 0 and 4. A Maximum Period Attribute has been attached to the Instance 4.

- when the "Discover" operation targets an Object with Object ID of 3 and Object Instance ID of 0, the response to the operation could be:

```
</3/0>;pmin=10;pmax=60, </3/0/1>, </3/0/2>, </3/0/3>, </3/0/4>, </3/0/6>;dim=2, </3/0/6/0>, </3/0/6/3>, </3/0/7>;dim=2;gt=50;lt=42.2, </3/0/7/0>, </3/0/7/1>;lt=45, </3/0/8>;dim=2, </3/0/8/1>, </3/0/8/2>, </3/0/11>, </3/0/16>
```

which means that regarding the Device Object Instance, a Maximum Period Attribute has been attached to this Instance level and a Minimum Period Attribute inherited from the Object level; the LwM2M Client supports the Multiple-Instance Resources 6, 7, and 8 with a dimension of 2 and has 2 additional Notification parameters attached to Resource 7.

- when the "Discover" operation targets an Object with Object ID of 3, Object Instance ID of 0, and a Depth of 0, the response to the operation could be:

```
</3/0>;pmin=10;pmax=60
```

which means that regarding the Device Object Instance, a Maximum Period Attribute has been attached to this Instance level and a Minimum Period Attribute inherited from the Object level.

- when the "Discover" operation targets an Object with Object ID of 3, Object Instance ID of 0, and Resource ID of 7 the response to the operation could be:

```
</3/0/7>;dim=2;pmin=10;pmax=60;gt=50;lt=42.2, </3/0/7/0>, </3/0/7/1>;lt=45
```

which means that regarding the Power Source Voltage of the Device Object, two Resource Instances with IDs 0 and 1 are present; a Less Than Attribute has been attached to this Resource, a Maximum Period Attribute and a Minimum Period Attribute are inherited from the Object and Object Instance levels; a different Less Than Attribute has been attached to the Resource Instance 1.

- If the Device Object (ID:3) having the Resource ID:7 with attached Attributes from two LwM2M Servers 1 and 2, then the answers to the "Discover" operation on both LwM2M Servers will be differentiated e.g.

from LwM2M Server 1: Discover /3/0/7 could provide the answer: </3/0/7>;dim=2;gt=50;lt=42.2, </3/0/7/0>, </3/0/7/1>

from LwM2M Server 2: Discover /3/0/7 could provide the answer: </3/0/7>;dim=2;pmax=300;gt=80;lt=65.5, </3/0/7/0>, </3/0/7/1>

### 6.3.3. Write Operation

The "Write" operation is used to change the value of a Resource, the value of a Resource Instance, the values of an array of Resources Instances or the values of multiple Resources from an Object Instance. The "Write" operation can also be used to request the deletion or the allocation of specific Instances of a Multiple-Instance Resource.

The LwM2M Client MUST perform the operation only if all the Resources conveyed in the operation are allowed to support the "Write" operation. If any Resource does not support the "Write" operation, the LwM2M Client MUST inform the LwM2M Server that the Object Instance cannot perform the requested operation by returning an error code indicating that the method is not allowed.

The request includes the value to be written encoded in one of the data format defined in Section [7.5. Data Formats for Transferring Resource Information](#).

The TLV, LwM2M CBOR, SenML CBOR or SenML JSON data format MUST be used in a "Write" request:

- when more than a single value of a Resource has to be changed
- when one or several Instances of a Multiple-Instance Resource have to be deleted or allocated.

The Write request MUST be rejected:

- if the specified data format is not supported by the LwM2M Client
- or if, checking the value of the incoming Resource against its data type, at least one of the following conditions is not met:
  - the value matches the expected format
  - the value is in the range specified in the Object definition
  - if the value is an ObjInk value, it must either point to an Object actually present in the LwM2M Client (the value will then be ObjectID:MAX\_ID), or point to an Object Instance actually present in the LwM2M Client, or contain the null pointer (the value will then be MAX\_ID:MAX\_ID)
- or if the deletion or allocation of an Instance of a Multiple-Instance Resource is not allowed by the LwM2M Client.

The LwM2M Client and LwM2M Server MUST support the following mechanisms to change multiple Resources or an array of Resource Instances:

- Replace: replaces the Object Instance or the Resource(s) with the new value provided in the "Write" operation. When the Resource is a Multiple-Instance Resource, the existing array of Resource Instances is replaced to the condition the LwM2M Client authorizes that operation.
- Partial Update: updates Resources provided in the new value and leaves other existing Resources unchanged. When the Resource is a Multiple-Instance Resource, the existing array of Resource Instances is updated meaning some Instances may be created or overwritten to the condition the LwM2M Client authorizes such operations. Deleting via Partial Update is not possible.

Note: Partial Update can also be done by the "Write-Composite" operation.

The "Write" operation has the following parameters:

Parameter	Required	Default Value	Notes
Object ID	Yes	–	Indicates the Object.
Object Instance ID	Yes	–	Indicates the Object Instance to write.
Resource ID	No	–	Indicates the Resource to write. If the final target is not a Resource Instance (see below), the payload is the new value for the Resource. The payload is the new value for the Resource. If no Resource ID is indicated, the Resource Instance ID MUST NOT be indicated, then the value included payload is an Object Instance containing the Resource values.
Resource Instance ID	No	–	Indicates the Resource Instance to write. An error MUST be returned by the Client, if the Resource ID is absent, if the targeted Resource is not defined as a Multiple-Instance Resource, or if the targeted Resource Instance doesn't exist.
New Value	Yes	–	The new value included in the payload to update the Object Instance, a Resource or a Resource Instance.

Table: 6.3.3.-1 Write Parameters

In a "Write" operation targeting an Object Instance, any optional Resources that are not supported by, or unknown to, the LwM2M Client MUST NOT be interpreted as an error by the LwM2M Client.

### 6.3.3.1. Examples

Let's consider a hypothetical Object 34 having a Multiple-Instance Resource 1 of type String with the following values:

```
/34/0/1/0: "Red"
/34/0/1/1: "Green"
```

The LwM2M Server performs a Write on /34/0/1 with the New Value containing:

```
[ { "n": "/34/0/1/1", "vs": "Yellow" },
  { "n": "/34/0/1/3", "vs": "Blue" } ]
```

For a Write Replace, the Object new values will be:

```
/34/0/1/1: "Yellow"
/34/0/1/3: "Blue"
```

For a Write Partial Update, the Object new values will be:

```
/34/0/1/0: "Red"
/34/0/1/1: "Yellow"
/34/0/1/3: "Blue"
```

### 6.3.4. Write-Attributes Operation

Only Attributes from the <NOTIFICATION> class MAY be changed in using the "Write-Attributes" operation.

The general rules for Attributes which are specified in Section [Attributes Definitions and Rules](#) fully apply here. [Table: 7.3.1.-1 Class Attributes](#) in Section [Attributes Classification](#) provides explanation on the Attributes supported by the "Write-Attributes" operation.

The value of a writable Attribute MUST be LwM2M Server specific.

The operation permits multiple Attributes to be modified within the same operation.

Including <NOTIFICATION> class Attributes specified in [Table: 7.3.1.-1 Class Attributes](#) Section [6.2.1. Register Operation](#), the "Write-Attributes" operation has the following parameters:

Parameter	Required	Default Value	Notes
Object ID	Yes	-	Indicates the Object.
Object Instance ID	No	-	Indicates the Object Instance. When this parameter is omitted, the Resource ID and Resource Instance ID parameters MUST NOT be indicated and Attributes in the parameters of the operation are valid for all resources of all instances of the Object according to the precedence rules (Section <a href="#">Attributes Definitions and Rules</a> ).
Resource ID	No	-	Indicates the Resource. When this parameter is omitted, then the ResourceInstance ID MUST NOT be indicated as well and it means the Attributes of this operation are set at an upper level (Object or Object Instance level).
Resource Instance ID	No	-	Indicates the Resource Instance. The LwM2M Client MUST return an error if the Resource ID is absent or if the targeted Resource is not defined as a Multiple-Instance Resource.
<NOTIFICATION> class Attributes	Yes		Indicates which Attributes are concerned. When an Attribute is specified without value, it means this Attribute value is unset at the level specified in the operation (Object, Object Instance, Resource, or Resource Instance levels).

Table: 6.3.4.-1 Write-Attributes Parameters

### 6.3.5. Execute Operation

The "Execute" operation is used by the LwM2M Server to initiate some action, and can only be performed on individual Resources. An LwM2M Client MUST return an error when the "Execute" operation is received for Object Instance(s) or Resource Instance(s).

If the Resource does not support the "Execute" operation, the LwM2M Client MUST return an error code indicating that the method is not allowed to the LwM2M Server.

The "Execute" operation MAY have arguments.

Parameter	Required	Default Value	Notes
Object ID	Yes	-	Indicates the Object.
Object Instance ID	Yes	-	Indicates the Object Instance.
Resource ID	Yes	-	Indicates the Resource to execute.
Arguments	No	-	The "Execute" operation accepts arguments. Arguments MUST be in plain text following the ABNF syntax below. Each DIGIT MUST appear at most once.

Table: 6.3.5.-1 Execute parameters

The syntax of the arguments is as follows:

```
arglist = arg *( "," arg )
arg = DIGIT / DIGIT "=" *CHAR ""
DIGIT = "0" / "1" / "2" / "3" / "4" / "5" / "6" / "7" / "8" / "9"
CHAR = "!" / %x23-26 / %x28-5B / %x5D-7E
```

Examples of valid lists of arguments:

- 5
- 2='10.3'

- 7,0=' <https://www.omaspecworks.org>'
- 0,1,2,3,4

### 6.3.6. Create Operation

The "Create" operation is used by the LwM2M Server to create Object Instance(s) within the LwM2M Client. The "Create" operation MUST target an Object, and MUST follow the rules specified in Section [8. Access Control](#) and its subsections. If any error occurs, it MUST NOT create anything.

The Object Instance created in the LwM2M Client by the LwM2M Server MUST be an Object type supported by the LwM2M Client and announced to the LwM2M Server using the "Register" and "Update" operations of the LwM2M Client Registration Interface.

Object Instance whose Object supports at most one Object Instance MUST be assigned an Object Instance ID of 0 when the Object Instance is Created.

The "Create" operation has the following parameters:

Parameter	Required	Default Value	Notes
Object ID	Yes	-	Indicates the Object.
New Value	No	-	The new value included in the payload to create the Object Instance(s).

Table: 6.3.6.-1 Create parameters

The New Value parameter included in the payload MUST follow the TLV, LwM2M CBOR, SenML CBOR or SenML JSON data format according to Section [7.5. Data Formats for Transferring Resource Information](#).

When there is no reference to an Object Instance in the TLV/LwM2M CBOR payload of the "Create" operation, the LwM2M Client MUST assign the ID of the created Object Instance.

If a new Object Instance is created through that operation and the "Access Control-Enabled" configuration is used, then the LwM2M Client creates an Access Control Object Instance for the created Object Instance (see Section [8. Access Control](#)) with the following requirements:

- The Access Control Owner MUST be the LwM2M Server.
- The LwM2M Server MUST have full access rights to the created Object Instance.

Any optional Resources included in the "Create" operation that are not supported by, or unknown to, the LwM2M Client MUST NOT be interpreted as an error by the LwM2M Client.

If a New Value parameter is not present or if it does not contain values for all Resources (mandatory and optional) of the Object, the LwM2M Client MAY populate the missing Resources with implementation dependent default values. If all the mandatory Resources of the created Object Instance are not instantiated, the LwM2M Client MUST return an error.

The values of the Read-only Resources MUST be setup by the LwM2M Client. If a value of a Read-only Resource is present in the "New Value" parameter then this value MUST NOT be processed nor should it result in an error. If the payload (New Value) conveys an Object Instance ID in conflict with one already present in the LwM2M Client then the entire request MUST be rejected and an error code indicating that the request is incorrect MUST be returned.

The LwM2M Client MAY reject the "Create" operation by returning an error code to the LwM2M Server.

### 6.3.7. Delete Operation

The "Delete" operation is used for LwM2M Server to delete an Object Instance or a Resource Instance within the LwM2M Client.

The Object Instance that is deleted in the LwM2M Client by the LwM2M Server MUST be an Object Instance that is

announced by the LwM2M Client to the LwM2M Server using the "Register" and "Update" operations of the Client Registration Interface.

The only exception concerns the single Instance of the mandatory Device Object (ID:3) which SHALL NOT be affected by any Delete operation.

The LwM2M Client MAY reject the "Delete" operation by returning an error code to the LwM2M Server.

The Delete operation has the following parameters:

Parameter	Required	Default Value	Notes
Object ID	Yes	-	Indicates the Object.
Object Instance ID	Yes	-	Indicates the Object Instance to delete if no Resource Instance ID is provided.
Resource ID	No	-	Indicates the Resource. When this parameter is provided, Resource Instance ID parameters MUST be provided.
Resource Instance ID	No	-	Indicates the Resource Instance to delete.

Table: 6.3.7.-1 Delete parameters

### 6.3.8. Read-Composite Operation

The LwM2M Client MAY support the "Read-Composite" operation.

The "Read-Composite" operation can be used by the LwM2M Server to selectively read any combination of Objects, Object Instance(s), Resources, and/or Resource Instances of different or same Objects in a single request. The list of elements to be read are provided as SenML Pack where the records contain Base Name and/or Name Fields, but no Value fields as specified in [RFC8790]. The Read-Composite operation is treated as non-atomic and handled as best effort by the LwM2M Client. That is, if any of the requested resources do not have a valid value to return, they will not be included in the response. Section [7.5.6. SenML JSON](#) shows examples of Read-Composite use.

The LwM2M Client MUST retrieve all the requested Resources except the Resource(s) which does not support the "Read" operation and sends the retrieved Resource(s) information to the LwM2M Server.

### 6.3.9. Write-Composite Operation

The LwM2M Client MAY support the "Write-Composite" operation.

In contrast to "Write" operation, the scope of which is limited to a Resource(s) of a single Instance of a single Object, the "Write-Composite" operation can be used by the LwM2M Server to update values of a number of different Resources across different Instances of one or more Objects. Similar to Read-Composite the Write-Composite operation provides a list of all resources to be updated, and their new values, using one of LwM2M CBOR, SenML JSON/CBOR, or SenML-ETCH JSON/CBOR formats. Unlike for Write operation, the Resources that are not provided are not impacted by the operation. Examples are shown in Section [7.5.6. SenML JSON](#).

The LwM2M Client MUST perform the operation only if all the Resources conveyed in the operation are allowed to support the "Write" operation. If any Resource does not support the "Write" operation, the LwM2M Client MUST inform the LwM2M Server that the Object Instance cannot perform the requested operation by returning an error code indicating that the method is not allowed.

The "Write-Composite" operation is atomic and cannot have partial success. That is, if the LwM2M Client supports this operation, it MUST reject a LwM2M Server request where it cannot successfully write all the requested values to the requested list of Resources. Therefore, before processing Write-Composite, the client MUST ensure that all addressed objects exist and that the Server has write access to those Objects and Resources.

## 6.4. Information Reporting Interface

The Information Reporting Interface is used by a LwM2M Server to observe any changes in a Resource on a registered LwM2M Client, receiving notifications when new values are available. This observation relationship is initiated by sending an "Observe" or "Observe-Composite" operation to the LwM2M Client for an Object, an Object Instance or a Resource. An observation ends when a "Cancel Observation" or "Cancel Observation-Composite" operation is performed.

The LwM2M Server and the LwM2M Client MUST support all the operations on this interface unless clearly stated otherwise.

The LwM2M Client MUST ignore LwM2M Server operations on this interface until it received its Registration acknowledgement.

The LwM2M Server SHOULD NOT perform any operation on this interface before replying to the registration request of this LwM2M Client.

The LwM2M Client MUST reject any LwM2M Server operation on the LwM2M Security Object (ID: 0) with a response code indicating that the operation is not authorized.

The LwM2M Client MUST reject any LwM2M Server operation on the LwM2M OSCORE Object (ID: 21) with a response code indicating that the operation is not authorized.

The LwM2M Client MUST reject any LwM2M Server operation on the LwM2M COSE Object (ID: 23) with a response code indicating that the operation is not authorized.

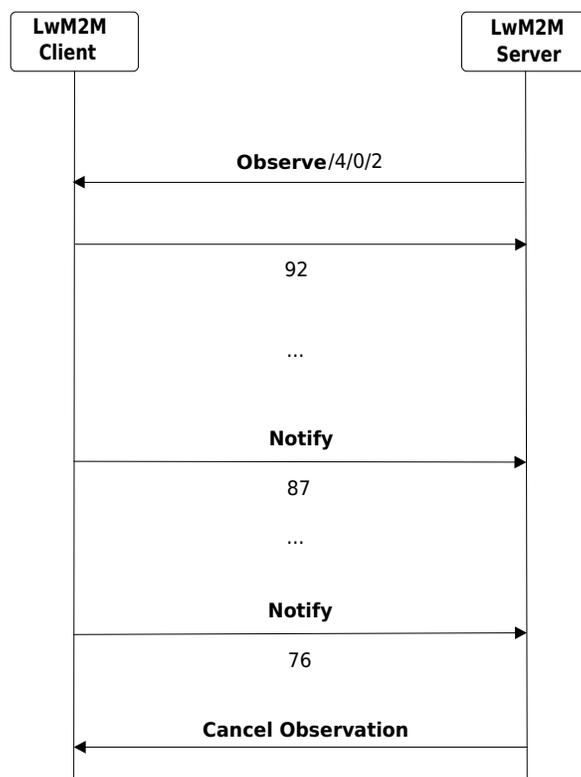

Figure: 6.4.-1 Example flow for Information Reporting Interface for the RSSI Resource of the Connectivity Monitoring Object of the example client Appendix LwM2M Objects defined by OMA (Normative)

The mapping to underlying transports is detailed in [LwM2M-TRANSPORT].

### 6.4.1. Observe Operation

The LwM2M Server initiates an observation request for changes of a specific Resource, Resources within an Object Instance or for all the Object Instances of an Object within the LwM2M Client.

Related attributes for "Observe" operation are described in [Table <NOTIFICATION> Class Attributes](#) in Section 7.3. [Attributes](#). The rules <NOTIFICATION> Attributes which are specified in this section fully apply here.

The "Observe" operation includes the following parameters:

Parameter	Required	Default Value	Notes
Object ID	Yes	-	Indicates the Object.
Object Instance ID	No	-	Indicates the Object Instance to observe. If no Object Instance ID is indicated, then Resource ID and Resource Instance ID MUST NOT be indicated as well, otherwise an error is returned by the Client; if no error, all the Instances of the Object are observed.
Resource ID	No	-	Indicates the Resource to observe. If no Resource ID is indicated, then the Resource Instance ID MUST NOT be indicated as well, and the whole Object Instance is observed.
Resource Instance ID	No	-	Indicates the Resource Instance to observe. An error MUST be returned by the Client, if no Resource ID is indicated or if the targeted Resource is not defined as a Multiple-Instance Resource.
Observation Attributes	No	-	<NOTIFICATION> Class Attributes valid only for this Observation. When these attributes are present, all the attached attributes of the targeted URI MUST be ignored for this Observation.

Table: 6.4.1. -1 Observe Parameters

If the Resource ID is specified and if the requested Resource does not support the "Read" operation, the LwM2M Client MUST return an error code indicating that the method is not allowed to the LwM2M Server.

If the Resource ID is not specified, the LwM2M Client MUST retrieve all the requested Resources except the Resource(s) which does not support the "Read" operation and sends the retrieved Resource(s) information to the LwM2M Server.

Until the LwM2M Client sends a new registration, the LwM2M Server expects the LwM2M Client to remember the observation requests. If a LwM2M Client forgets the observation requests (e.g. device factory reset) it MUST perform a new "Register" operation. The LwM2M Server MUST re-initiate the desired observation requests whenever the LwM2M Client registers.

In order to avoid network traffic increase, the LwM2M Client SHOULD maintain previous observation states in case of reboot, power cycle.

It has to be noted that an "Observe" operation containing only Object ID, will produce the report of all Object Instances information.

The LwM2M Client SHOULD support the "Observation Attributes" parameter. If the LwM2M Client does not support the "Observation Attributes" parameter, it MUST reject an observation that includes Observation Attributes.

Note: The <NOTIFICATION> Class Attributes can also be configured by the "Write-Attributes" operation described in section 6.3.4. [Write-Attributes Operation](#). In that case, the Attributes will be permanent and apply to all "Observe" operations not specifying their own.

Note: The <NOTIFICATION> Class Attributes contained in the "Observation Attributes" parameter are not part of the LwM2M Client response to a Discover operation since they are not attached.

Note: When a LwM2M Client deregisters, the LwM2M Server should assume past states are nullified including the previous observations.

### 6.4.2. Notify Operation

Note: For readability in this section, the term "Resource value" is used to designate either the value of a Single-Instance

Resource, or the value of an Instance of a Multiple-Instance Resource, according to the nature of the considered Resource (i.e. Single- or Multiple-Instance Resource).

The "Notify" operation is sent from the LwM2M Client to the LwM2M Server during a valid observation on an Object, Object Instance, Resource, or Resource Instance. The "Notify" operation MUST be sent when the state of the observed item changes and all conditions (i.e. Minimum Period, Maximum Period, Greater Than, Less Than, Step) are met, or when the "Maximum Period" timing condition is fulfilled. These conditions are either "Observation Attributes" sent as parameters or attributes attached at the level of the "Observe" operation.

Any attributes attached at lower levels (e.g., at the Resource level if the observation is created at the Object Instance level) MUST be ignored.

The LwM2M Client MUST retrieve all the observed Resources values except for the Resource(s) which does not support the "Read" operation and send the retrieved Resource value(s) to the LwM2M Server.

The response sent by a LwM2M Client to an "Observe" or "Observe-Composite" operation MUST be considered as the initial notification.

Each time a "Notify" operation is sent, the "Minimum Period" and "Maximum Period" timers associated to this "Observe" or "Observe-Composite" operation are restarted.

Additionally, a "Maximum Period" (pmax) applied to an observation smaller than the "Minimum Period" applied to the same observation MUST be ignored for that observation.

Note: The conditions may be modified by the "Write-Attributes" operation after the observation request. The LwM2M Client behavior is implementation dependent for the evaluation of the Change Value Conditions started prior to the "Write-Attributes" operation. For deterministic behavior when changing observation attributes, the current observation SHOULD be cancelled and a new observation SHOULD be created with the desired observation attributes. However, some information may be lost in the transition between the two observations.

Parameter	Required	Default Value	Notes
Updated Value	Yes	-	The new value included in the payload about the Object Instance or Resource.

Table: 6.4.2.-1 Notify Parameters

The following example shows how the Minimum and Maximum period parameters work as shown in Section [6.3.4. Write-Attributes Operation](#). An LwM2M Server makes an observation for a Temperature Resource that is updated inside the LwM2M Client at irregular periods (based on change). The LwM2M Server makes an observation when the Minimum Period = 10 Seconds and Maximum Period = 60 Seconds attributes have been set for that Resource. The LwM2M Client will wait at least 10 Seconds before sending a "Notify" operation to the LwM2M Server (even if the Resource has changed before that), and no longer than 60 Seconds before sending a "Notify" operation (even if the Resource has not changed yet). The "Notify" operation is sent anywhere between 10-60 seconds upon change.

Note: In case an "Observe" operation is initiated on a Resource, an Object Instance or an Object without any conditions previously configured, and with the "Default Minimum Period" in the LwM2M Server Object set to 0 (possibly by default), the "Notify" operation will be sent upon any change of, respectively, the observed Resource value, any Resource value of the observed Object Instance or any Resource value of any Instance of the observed Object. As specified in Section [6.4.1. Observe Operation](#) and in [Table: 6.4.1.-1 Observe Parameters](#), in case of an "Observe" operation on a certain Object the "Notify" operation includes all Resources of all Instances of the observed Object.

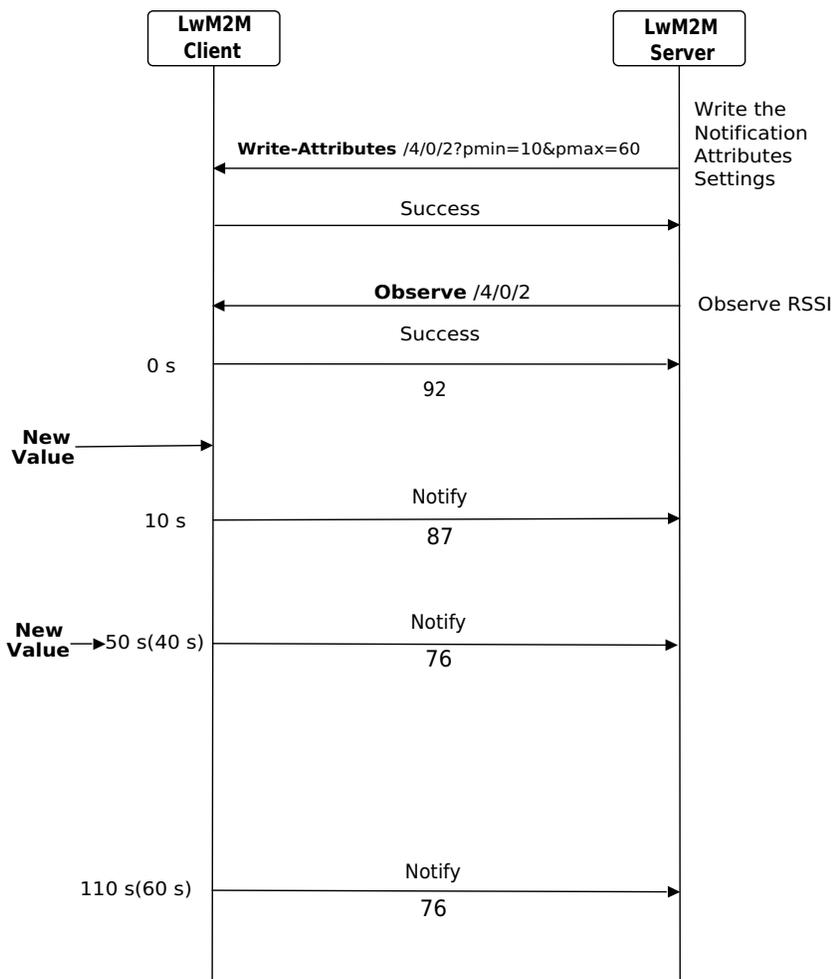

Figure: 6.4.2.-1 Example of Minimum and Maximum periods in an Observation

In this example the Minimum Period has been set to 10 and the Maximum Period set to 60 for the Resource `/4/0/2` before making the observation.

### 6.4.3. Cancel Observation Operation

The "Cancel Observation" operation is sent from the LwM2M Server to the LwM2M Client to end an observation relationship that was previously created with an "Observe" operation.

### 6.4.4. Observe-Composite Operation

The LwM2M Client MAY support the "Observe-Composite" operation.

The LwM2M Server can use the "Observe-Composite" operation to initiate observations for a group of resources and/or resource instances across multiple object instances within the client. As with the "Read-Composite" operation, the list of elements to be observed is provided as a separate parameter to the operation in SenML JSON/CBOR format.

The <NOTIFICATION> Class Attributes for each resource that is observed through the "Observe-Composite" operation may be individually configured by the LwM2M Server using the "Write-Attribute". Each resource can have multiple observe conditions attached. If any of the conditions attached to one or more resources under observation meets the notification criteria a notify will be generated by the LwM2M Client, which will include the value for each of the resources listed in the "Observe-Composite" operation. Hence, the resources that have not met the notify condition will still be included in the notification message.

Note: It is the responsibility of the LwM2M Server to ensure that the Minimum and Maximum Period Attributes attached to observed resources follow the rules defined in Section [Attributes Classification](#). For example, the Minimum Period Attributes attached to targeted resources must be less than the Maximum Period Attributes attached to all targeted resources.

As with the "Observe" operation, <NOTIFICATION> Class Attributes can be provided as a separate parameter to the operation. However, these attributes MUST have the Object Attachment Level, i.e. Minimum Period, Maximum Period, Minimum Evaluation Period, Maximum Evaluation Period, and Confirmable Notification. When these attributes are present, all the attached or inherited Attributes with the Object Assignment Level of the targeted URI MUST be ignored for this Observation-Composite.

For example, the following attributes are attached to the Device Object and the Connectivity Monitoring Object:

```
</3>;pmin=60
</4>;pmax=300
```

if the LwM2M Server performs an Observe-Composite operation on the Resources /3/0/8 and /4/0/2 with a parameter Minimum Evaluation Period set to 30, when evaluating the Notification conditions for this Observation-Composite, the LwM2M Client will ignore the Minimum Period and Maximum Period attributes inherited by the Resources and will consider only the Minimum Evaluation Period on both Resources.

### 6.4.5. Cancel Observation-Composite Operation

If the "Observe-Composite" operation is supported by the LwM2M Client, the "Cancel Observation-Composite" operation MUST be supported by the LwM2M Client.

The "Cancel Observation-Composite" operation is sent from the LwM2M Server to the LwM2M Client to end the previously set up composite observation relationship.

### 6.4.6. Send Operation

The LwM2M Client and the LwM2M Server MAY support the "Send" operation.

The "Send" operation is used by the LwM2M Client to send data to the LwM2M Server without explicit request by that LwM2M Server.

The "Send" operation can be used by the LwM2M Client to report values for Resources and Resource Instances of LwM2M Object Instance(s) to the LwM2M Server. The Resources and Resource Instances to send is implementation specific. The LwM2M Server MAY use the "Mute Send" Resource in the LwM2M Server Object (Resource ID 23) to enable or disable the use of the "Send" operation. When information reporting should be controlled by the LwM2M Server, the "Observe" or "Observe-Composite" operations can be used.

The reported LwM2M Object Instances (potentially different Object types) MUST have been registered by the LwM2M Client to the LwM2M Server. That LwM2M Server MUST have Read access right granted on the Object Instances of the reportable Resources which MUST support the Read operation (see Section [8.2. Authorization](#)). If these criteria are not met for some Resources, the LwM2M Client MUST NOT include those Resources in the "Send" operation.

Any optional Resources included in the "Send" operation that are not supported by, or unknown to, the LwM2M Server MUST NOT be interpreted as an error by the LwM2M Server.

In addition, if any of the rules mentioned below is violated, the LwM2M Server MUST respond with an error in reply to the "Send" operation.

The value included in the payload MUST be either LwM2M CBOR, SenML JSON, or SenML CBOR format described in Section [7.5. Data Formats for Transferring Resource Information](#). As example:

Reporting the location of the LwM2M Client and the radio signal strength in a JSON payload:

```
Send
New Value:
[
  {"n":"/6/0/0", "v":43.61092},
```

```
{ "n": "/6/0/1", "v": 3.87723 },  
{ "n": "/4/0/2", "v": -49 }  
]
```

## 7. Identifiers and Resources

This section defines the identifiers and resource model for the LwM2M Enabler.

### 7.1. Resource Model

The LwM2M Enabler defines a simple resource model where each piece of information made available by the LwM2M Client is a Resource. Resources are logically organized into Objects. Each Resource is given a unique identifier within that Object and a data type among those defined in Section [Appendix C. Data Types \(Normative\)](#).

[Figure: 7.1.-1 Relationship between LwM2M Client, Object, and Resources](#) illustrates this structure, and the relationship between Resources, Objects, and the LwM2M Client. The LwM2M Client may have any number of Resources, each of which belongs to an Object; for example the Firmware Update Object contains all the Resources used for firmware update purposes.

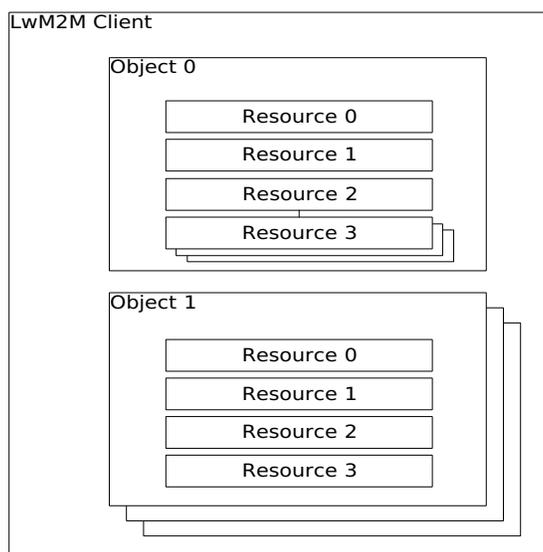

Figure: 7.1.-1 Relationship between LwM2M Client, Object, and Resources

Each Object, defined for the LwM2M Enabler, is assigned a unique OMA LwM2M Object identifier allocated and maintained by [OMNA]. The LwM2M Enabler defines standard Objects and Resources, see Section [Appendix E. LwM2M Objects defined by OMA \(Normative\)](#). Further Objects may be added by OMA or other organizations to enable additional M2M Services.

As an Object only specifies a grouping of Resources, an Object **MUST** first be instantiated so that the LwM2M Client can use the Resources of such an Object and the associated functionalities.

When an Object is instantiated – either by the LwM2M Server or the LwM2M Client – an Object Instance is created with a subset of the Resources defined in the Object specification; a LwM2M Server can then access that Object Instance and its set of instantiated Resources.

A Resource which is instantiated within an Object Instance is a Resource which can either:

- contain a value (if the Resource is Readable and/or Writeable)
- or can be addressed by a LwM2M Server to trigger an action in the LwM2M Client (if the Resource is Executable)

Data Type checking on a Resource value **MUST** be performed:

- by the LwM2M Client when the LwM2M Server tries to set such a Resource,
- by the LwM2M Server when the LwM2M Server retrieves such a Resource

The LwM2M Client MUST reject a request, if an error is detected when checking an incoming Resource value against its data type.

The Object specification defines the operations (Read, Write, Execute) which are individually supported by the Resources belonging to that Object; this specification also defines the Mandatory or Optional characteristics of such Resources.

A Resource specified as Mandatory within an Object MUST be instantiated in any Instance of that Object.

A Resource specified as Optional within an Object MAY be omitted from some or even all Instances of that Object.

As illustration, the following example using the discover operation on the Server Object, exposes a configuration in which the Server Object (ID:1) has 2 Instances (ID:0, ID:1): the Optional Resources ID:2, ID:4 are only instantiated in the Instance 1 of the Object, while the Optional Resources ID:3 and ID:5 are not instantiated in either of the Server Object Instances. In Server Object ID:1, the Resources 0,1, and 6,7,8 are Mandatory Resources.

According to the DISCOVER /1 request, the following payload is returned:

```
</1/0/0>,</1/0/1>,</1/0/6>,</1/0/7>, </1/0/8>, </1/1/0>,</1/1/1>,</1/1/2>,</1/1/4>,</1/1/6>,</1/1/7>, </1/1/8>
```

Objects and Resources have the capability to have multiple instances. Multiple-Instance Resources can be instantiated by LwM2M Server operations in using SenML JSON, SenML CBOR, LwM2M CBOR, or TLV formats (see Section 7.5. [Data Formats for Transferring Resource Information](#)). The LwM2M Client also has the capability to instantiate Single or Multiple-Instance Resources.

The LwM2M Server performs operations on an Object, Object Instance and Resources as described in Section 6. [Interfaces](#). These operations are conveyed as described in [LwM2M-TRANSPORT] and how to convey the Operation data is defined in Section 7.5. [Data Formats for Transferring Resource Information](#).

The LwM2M Enabler defines an access control mechanism per Object Instance. Object Instances SHOULD have an associated Access Control Object Instance. An Access Control Object Instance contains Access Control Lists (ACLs) that define which operations on a given Object Instance are allowed for which LwM2M Server(s).

[Figure 7.1.-2 Example of Supported operations and Associated Access Control Object Instance](#) shows an example of the operations the Resources support and how Object Instances and Resources are associated with Access Control Object Instance. In the example, Object Instance 0 for Object 1 has 2 Resources. Resource 1 supports the "Read", "Write" operations, while Resource 0 supports only the "Read" operation. The associated Access Control Object Instance has ACL of Object Instance 0 for Object 1. LwM2M Server 1 is authorized to perform "Read" and "Write" operations to the Object Instance 0 for Object 1 and Resources of the Object Instance. However, due to the supported operations of each Resource, LwM2M Server 1 can perform the "Read" operation on Resource 1 and 0, and also can perform the "Write" operations on Resource 1, but LwM2M Server 1 cannot perform the "Write" operation on Resource 0. The detailed access control mechanism is defined in Section 8. [Access Control](#).

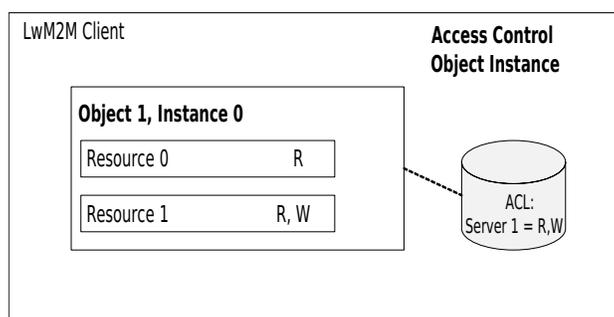

Figure: 7.1.-2 Example of Supported operations and Associated Access Control Object Instance

## 7.2. Object Versioning

### 7.2.1. General Policy

The official specification of the Objects is available at [OMNA].

An LwM2M Server MUST be able to determine without ambiguity the specification of the Objects intended to be registered by the LwM2M Client.

An LwM2M Object can evolve. Object versioning aims at identifying these LwM2M Object modifications, which can be categorized in two types:

- Evolution of type I: representing non-backwards-compatible ("breaking") evolutions are:
  - changing the "Instances" characteristic of the Object.
  - changing the normative text in the Object description.
  - adding or removing a mandatory Resource.
  - modifying the list of allowed operations of a Resource.
  - changing the "Instances" characteristic of a Resource.
  - changing the Data Type of a Resource.
  - modifying the Range of a Resource value (not associated with new enumeration values described in type II).
  - removing a Resource enumeration value.
  - changing the unit of a Resource.
  - changing the normative text in a Resource description.
- Evolution of type II: representing backwards-compatible ("non-breaking") evolutions are:
  - changing the non-normative text in the Object description.
  - adding or removing an optional Resource.
  - adding a Resource enumeration value.
  - reusing a Resource enumeration value, which was marked as "reserved".
  - changing the non-normative text in a Resource description.

Any other changes are forbidden (e.g. changing the name of an Object, changing the name of a Resource, or reusing a previously removed Resource ID).

With Object versioning, the Object Identifier is not changed but a new URN identifying that particular version of the Object specification MUST be registered according to the following format

"urn:oma:lwm2m:{oma, ext, x}:ObjectID[:{version}]" where 'version' is the Object Version as defined in the following section

### 7.2.2. Object Version format

The Object Version of an Object is composed of 2 digits separated by a dot '.':

- the first digit represents the Major Version of the Object: this digit marks the non-backward compatible evolution of such an Object (Object evolution of type I: Section [7.2.1. General Policy](#))
- the second digit represents the Minor Version of the Object: this digit marks the backward compatible evolution of such an Object (Object evolution of type II: Section [7.2.1. General Policy](#))

By convention when an Object is in version 1.0, the Object Version MAY be omitted in the URN.

To be more precise, two separate URNs are accepted as valid for the corresponding version of the object specification:

- the URN where the Object Version is mentioned explicitly: "urn:oma:lwm2m:{oma, ext, x}:ObjectID:1.0"
- the URN where the Object Version is absent: "urn:oma:lwm2m:{oma, ext, x}:ObjectID" (and supposed to be 1.0).

Example: "urn:oma:lwm2m:oma:44:2.2"

This URN uniquely identifies Object ID:44 in its version "2.2". Registered Objects are available at [OMNA], see Section [7.4. Identifiers](#) and Section [Appendix J. LwM2M Schema and Object Definition File \(Informative\)](#) for further information.

### 7.2.3. Object Definition and Object Version Usage

Objects can be either:

- Core Objects, which are LwM2M Objects specified within the LwM2M Enabler specification (e.g. the Device Object).
- Non-core Objects, which are LwM2M Objects specified outside of an LwM2M Enabler specification (e.g. the Cellular Connectivity Object, which is defined in its own OMA specification, or any Object from a third party).

An LwM2M Client can always attach Object Version information to an Object. In certain circumstances Object Version information can, however, be omitted.

If a Core Object version does not correspond to version contained in the LwM2M Enabler release supported by the LwM2M Client, the Object Version MUST be provided by the LwM2M Client to the LwM2M Server.

If a Non-core Object is not version 1.0, the Object Version MUST be provided by the LwM2M Client to the LwM2M Server.

In "Register", "Register Update", and "Discover" operations, when the Object Version of a given Object is communicated, the LwM2M Client MUST use the Object Version <PROPERTIES> Class attribute ("ver"). If the Object has no Object Instance or several Object Instances, the Object Version attribute MUST be attached to the Object link. If the Object has exactly one instance, the Object link MAY be omitted. In that case, the Object Version attribute MUST be associated to the Object Instance link.

A few examples:

1. An LwM2M Client supporting LwM2M Enabler version 1.1 registers the Server Object version 1.1 ("urn:oma:lwm2m:oma:1:1.1"), and the Device Object version 1.1 ("urn:oma:lwm2m:oma:3:1.1"). The registration payload is:

```
</1/0>,</1/1>,</3/0>
```

2. An LwM2M Client supporting LwM2M Enabler version 1.1 registers the Server Object version 1.0 ("urn:oma:lwm2m:oma:1"), and the Device Object version 1.1 ("urn:oma:lwm2m:oma:3:1.1"). The registration payload is:

```
</1>;ver=1.0,</1/0>,</1/1>,</3/0>
```

3. At [OMNA], the Object ID:44 will be registered at least twice:

- with the URN "urn:oma:lwm2m:oma:44" (version 1.0)
- with the URN "urn:oma:lwm2m:oma:44:2.2"

An LwM2M Client supporting LwM2M Enabler version 1.0 registers this Object in version 2.2 along with the Server Object version 1.0 ("urn:oma:lwm2m:oma:1"), and the Device Object version 1.0 ("urn:oma:lwm2m:oma:3"). The registration payload is:

```
</1/0>,</1/1>,</3/0>,</44/0>;ver=2.2
```

4. An LwM2M Client supporting LwM2M Enabler version 1.1 registers the Server Object version 1.1 ("urn:oma:lwm2m:oma:1:1"), the Device Object version 1.1 ("urn:oma:lwm2m:oma:3:1.1"), and the Connectivity Monitoring Object version 1.2 ("urn:oma:lwm2m:oma:4:1.2"). Because each of these Object versions correspond to the Object versions released as part of the LwM2M Enabler version 1.1, the Object version information can be omitted. The registration payload is:

```
</1>,</1/0>,</1/1>,</3/0>,</4/0>
```

## 7.3. Attributes

Attributes are metadata which can be attached to an Object, an Object Instance, a Resource, or a Resource Instance. These attributes can fulfil various roles, from carrying information only (e.g. Discover) to carrying parameters for setting up certain actions on the LwM2M Client (e.g. Notifications). These Attributes may be carried in the message payload of Registration and Discover operations. They can be updated – when writable – through the "Write-Attributes" operation.

An attribute is fully determined by several characteristics, which are listed in [Table: 7.3.-1 Attribute Characteristics](#).

Attribute characteristic	Description
Name	Attribute Name used to reference a specific Attribute in that Enabler (e.g. "Minimum Period")
CoRE Link Param	The encoding used when this Attribute is transferred through a CoRE link parameter. See section 2 of [RFC6690]
Attachment	The Level (Object, Object Instance, Resource, Resource Instance) to which an Attribute is attached
Access Mode	R, W, RW: operation allowed by the LwM2M Server.
Value Type	Data Type (Refer <a href="#">Appendix C. Data Types (Normative)</a> )
Default Value	<value> or "-" or " "
Applicability	Condition to fulfil for allowing to attach such an Attribute

Table: 7.3.-1 Attribute Characteristics

The value of Attributes marked as "R" (readable) are exposed to the LwM2M Server in the payload response to a "Discover" operation (Section [6.3.2. Discover Operation](#)).

The value of Attributes marked as "W" (writable) can be changed by the LwM2M Server in using the "Write-Attributes" operation (Section [6.3.4. Write-Attributes Operation](#)).

Note: A payload response to a "Discover" operation is a list of application/link-format CoRE Links [RFC6690], which will include the LwM2M Attributes.

### 7.3.1. <PROPERTIES> Class Attributes

The role of these Attributes is to provide metadata which may communicate helpful information to the LwM2M Server for example easing data management.

The LwM2M Server, the LwM2M Bootstrap-Server, and the LwM2M Client SHOULD support [Table: 7.3.1.-1 Class Attributes](#), except when specifically mentioned as not required.

Attribute Name	CoRE Link param	Attachment	Access Mode	Value Type	Default Value	Applicability	Notes	Support Required
Dimension	"dim" "=" 1*DIGIT	Resource	R	Integer [0:65535]	-	Multiple-Instance Resource	Number of instances existing for a Multiple-Instance Resource	YES (Client)
Short Server ID	"ssid" "=" 1*DIGIT	Object Instance	R	Integer [1:65534]	-	Security, Server and OSCORE Objects	Provides the LwM2M Server Short ID information (see Section <a href="#">6.1.7.3. Bootstrap-Discover Operation</a> )	YES (Client)
Server URI	"uri" "=" quoted-string	Object Instance	R	String	-	LwM2M Security Object	Provides the LwM2M Server URI information (see Section <a href="#">6.1.7.3. Bootstrap-Discover Operation</a> )	YES (Client)
Object Version	"ver" "=" 1*DIGIT "." 1*DIGIT	Object	R	String	1.0		Provides the version of the associated Object. The rules governing the usage of this parameter are specified in <a href="#">7.2.3. Object Definition and Object Version Usage</a> .	YES (Server) YES (Client) when able to support Objects in version > 1.0
Enabler Version	"lwm2m" "=" 1*DIGIT "." 1*DIGIT	None	R	String	-		Used exclusively in the response to a <a href="#">6.1.7.3. Bootstrap-Discover Operation</a> to provide the version of the supported LwM2M Enabler.	YES (Bootstrap-Server) YES (Client)

Table: 7.3.1.-1 &lt;PROPERTIES&gt; Class Attributes

### 7.3.2. <NOTIFICATION> Class Attributes

The role of these Attributes is to provide parameters to the "Notify" operation.

These Attributes can be attached at various levels: Object, Object Instance, Resource levels, or Resource Instance. The rules below govern the usage of these Attributes:

- Inheritance: <NOTIFICATION> attributes apply to the level they are attached to, and to the lower.

For instance, a <NOTIFICATION> attribute attached to an Object Instance applies also to "Notify" operation on the Resources and Resource Instances of this Object Instance.

- Precedence: <NOTIFICATION> attributes attached to a level prevail over the same attribute attached to an upper level.

For instance, if the same <NOTIFICATION> attribute is attached to both an an Object Instance and a Resource of this Object Instance, "Notify" operation on this Resource (and its Resource Instances in the case of a Multiple-Instance Resource) will consider only the value of the attribute attached to the Resource.

The "Greater Than", "Less Than", and "Step" values MUST respect the two following conditions:

- "lt" value < "gt" value
- ("lt" value + 2\*"st" values) < "gt" value

When the "Greater Than", "Less Than", and "Step" Attributes are set in a Write-Attributes operation, or passed as parameter to an "Observe" or "Observe-Composite" operation, the operation MUST be rejected if the conditions above are violated.

The "Minimum Evaluation Period" (epmin) and "Maximum Evaluation Period" (epmax) values can be used to configure the device to perform reporting evaluations. After the expiry of epmin, the device MAY immediately perform an evaluation per the "Notification Conditions" above. After the expiry of epmax, the device MUST perform an evaluation per the "Notification Conditions". If both the epmin and epmax attributes are defined, the epmin value must be less than the epmax value.

The behaviour of Notification class attributes MUST follow [Cond\_Attr] unless stated otherwise in this specification.

Note: The attribute Maximum Historical Queue is specified in this specification but currently not referenced in [Cond\_Attr]. [Cond\_Attr], however, introduced the Notification Band (c.band) attribute, which is not used in this version of LwM2M specification.

The LwM2M Server MUST support and LwM2M Client SHOULD support all the <NOTIFICATION> Class Attributes listed in [Table: 7.3.2.-1 class Attributes](#).

Attribute Name	CoRE Link param	Attachment	Access Mode	Value Type	Default Value	Applicability
Minimum Period	"pmin" "=" 1*DIGIT	Object Object Instance Resource Resource Instance	RW	Integer	0 (sec)	Readable Resource
<p><i>Notes:</i> The Minimum Period Attribute indicates the minimum time in seconds the LwM2M Client MUST wait between two notifications. If a notification of an observed Resource is supposed to be generated but it is before pmin expiry, notification MUST be sent as soon as pmin expires. In the absence of this parameter, the Minimum Period is defined by the Default Minimum Period set in the LwM2M Server Account.</p>						
Maximum Period	"pmax" "=" 1*DIGIT	Object Object Instance Resource Resource Instance	RW	Integer	-	Readable Resource
<p><i>Notes:</i> The Maximum Period Attribute indicates the maximum time in seconds the LwM2M Client MAY wait between two notifications. When this "Maximum Period" expires after the last notification, a new notification MUST be sent. In the absence of this parameter, the "Maximum Period" is defined by the Default Maximum Period when set in the LwM2M Server Account or considered as 0 otherwise. The value of 0, means pmax MUST be ignored. The maximum period parameter MUST be greater than or equal to the minimum period parameter otherwise pmax will be ignored for the Resource to which such inconsistent timing conditions are applied.</p>						
Greater Than	"gt" "=" 1*DIGIT [ "." 1*DIGIT ]	Resource Resource Instance	RW	Float	-	Numerical & Readable Resource
<p><i>Notes:</i> This "gt" Attribute defines a threshold high value. When this Attribute is present, the LwM2M Client MUST notify the Server each time the Observed Resource value crosses this threshold with respect to the pmin parameter and valid "Change Value Conditions" (see Notification Conditions above).</p>						
Less Than	"lt" "=" 1*DIGIT [ "." 1*DIGIT ]	Resource Resource Instance	RW	Float	-	Numerical & Readable Resource
<p><i>Notes:</i> This "lt" Attribute defines a threshold low value. When this Attribute is present, the LwM2M Client MUST notify the Server each time the Observed Resource value crosses this threshold with respect to the pmin parameter and valid "Change Value Conditions" (see Notification Conditions above).</p>						
Step	"st" "=" 1*DIGIT [ "." 1*DIGIT ]	Resource Resource Instance	RW	Float	-	Numerical & Readable Resource
<p><i>Notes:</i> This "Step" Attribute defines a minimum change value between two notifications. When this Attribute is present, the Change Value Condition will occur when the value variation since the last notification of the Observed Resource, is greater or equal to the "Step" Attribute value. When the "Step" Change Value Condition occurs, the LwM2M Client MUST notify the Server with respect to pmin parameter and "Valid Value Conditions" (see notification Conditions above).</p>						
Minimum Evaluation Period	"epmin" "=" 1*DIGIT	Object Object Instance Resource Resource Instance	RW	Integer	-	Readable Resource
<p><i>Notes:</i> The Minimum Evaluation Period Attribute indicates the minimum time in seconds the LwM2M Client MUST wait between two evaluations of reporting criteria. In the absence of this parameter, the Evaluation Minimum Period is not defined.</p>						
Maximum Evaluation Period	"epmax" "=" 1*DIGIT	Object Object Instance Resource Resource Instance	RW	Integer	-	Readable Resource
<p><i>Notes:</i> The Maximum Evaluation Period Attribute indicates the maximum time in seconds the LwM2M Client MAY wait between two evaluations of reporting criteria. When the Maximum Evaluation Period expires after the previous evaluation, a new evaluation MUST occur. In the absence of this parameter, the Maximum Evaluation Period is not defined.</p>						
Edge	"edge" "=" ( "0" / "1" )	Resource Resource Instance	RW	Integer	-	Boolean & Readable Resource

<p><i>Notes:</i> The Edge Attribute indicates either the falling edge ("0") or the rising edge ("1") transition of a Boolean Resource. When this Attribute is present, the LwM2M Client MUST notify the Server each time the Observed Resource value goes from "true" to "false" (edge = "0"), or from "false" to "true" (edge = "1") with respect to the pmin parameter and valid "Change Value Conditions" (see Notification Conditions above).</p>						
Confirmable Notification	"con" "=" ( "0" / "1" )	Object Object Instance Resource Resource Instance	RW	Integer	-	Readable Resource
<p><i>Notes:</i> The Notification Confirmable Attribute indicates whether a Notification resulting from an Observation of a specific Object, Object Instance, Resource, Resource Instance MUST be sent over confirmable transport. If a Notification includes several Objects or Object Instances or Resources or Resource Instances or a combination thereof, then this Notification MUST be sent over confirmable transport if at least one of the Notification components has con=1.</p>						
Maximum Historical Queue	"hqmax" "=" 1*DIGIT	Object Object Instance Resource Resource Instance	RW	Integer	-	Readable Resource
<p><i>Notes:</i> The Maximum Historical Queue Attribute indicates how many entries of historical data resulting from an Observation of a specific Object, Object Instance, Resource, Resource Instance MUST be stored, e.g. while the LwM2M Client is offline, or, the LwM2M Server account is disabled. If this attribute is present, only the data of Objects, Object Instances, Resources, Resource Instances with hqmax&gt;0 will be included in notifications which were stored while disabled or offline. Historical notifications MAY be sent in a format as described in Section <a href="#">7.5.6. SenML JSON</a>. If the queue size reaches hqmax and a new reading is received, the oldest reading MUST be dropped. The LwM2M Client SHOULD empty the queue as soon it becomes aware that connectivity has been restored. The use of "hqmax" is dependent on notification storing being enabled via the "Notification Storing When Disabled or Offline" Resource of the LwM2M Server Object.</p>						

Table: 7.3.2.-1 &lt;NOTIFICATION&gt; class Attributes

## 7.4. Identifiers

The LwM2M Enabler defines specific identifiers for entities used within the LwM2M Protocol. These identifiers are defined in [Table: 7.4.-1 LwM2M Identifiers](#).

Identifier	Format	Description
Endpoint Client Name	String	Identifies the LwM2M Client on one LwM2M Server (including LwM2M Bootstrap-Server).  This parameter is optional and provided to the LwM2M Server during Registration, also provided to LwM2M Bootstrap-Server when executing the Bootstrap procedure. It MUST be provided when the security protocol does not provide an authenticated identifier or this information is not available for the server.  The Endpoint Client Name is a string. Recommended URI and URN formats are documented in <a href="#">7.4.1. Endpoint Client Name</a> .
LwM2M Bootstrap-Server URI	URI	Uniquely identifies the LwM2M Bootstrap-Server. Provided to the LwM2M Client during the Bootstrap procedure.
LwM2M Server URI	URI	Uniquely identifies the LwM2M Server. Provided to the Client during Bootstrap procedure.
Short Server ID	16-bit unsigned integer	Uniquely identifies each LwM2M Server configured for the LwM2M Client. Assigned during the Bootstrap procedure.  The values '0' and MAX_ID '65535' are reserved values and MUST NOT be used for identifying a LwM2M Server.
Human Readable Object URN	URN for the OMA Management Object	Assigned by the Object specification.
Object ID	16-bit unsigned integer	Uniquely identifies an Object in the LwM2M Client. This identifier is assigned by OMA. MAX_ID 65535 is a reserved value and MUST NOT be used for identifying an Object.
Object Instance ID	16-bit unsigned integer	Uniquely identifies an Object Instance of an Object within the LwM2M Client. This identifier is assigned by the LwM2M Client or LwM2M Server. MAX_ID 65535 is a reserved value and MUST NOT be used for identifying an Object Instance.
Resource ID	16-bit unsigned integer	Uniquely identifies a Resource within an Object. Short integer ID, with a range assigned by the Object specification and unique to that Object, and a Reusable Resource ID range assigned by OMA and re-usable between Objects. MAX_ID 65535 is a reserved value and MUST NOT be used for identifying a Resource.
Resource Instance ID	16-bit unsigned integer	Uniquely identifies a Resource Instance of a Resource. This identifier is assigned by a LwM2M Client or LwM2M Server. MAX_ID 65535 is a reserved value and MUST NOT be used for identifying a Resource Instance.

Table: 7.4.-1 LwM2M Identifiers

### 7.4.1. Endpoint Client Name

The Endpoint Client Name is a string. URIs and URNs are RECOMMENDED formats for this identifier. The Endpoint Client Name identifier MUST be unique at the LwM2M server or servers it is being used with. Note that the Endpoint Client Name is unauthenticated and can be set to arbitrary value by a misconfigured or malicious client and hence MUST NOT be used alone for any decision making without prior matching the Endpoint Client Name against the identifier used with the security protocol protecting LwM2M communication. This parameter MAY be omitted when the security protocol provides the server an authenticated identifier that is identical to this parameter. For more discussion consult the security consideration section in the [LwM2M-TRANSPORT] specification. This security consideration section also provides a description of the privacy implications of re-using the same identifiers across multiple servers.

This specification RECOMMENDS the Endpoint Client Name to be in a URI or a URN format for uniqueness reasons. The following table lists URN formats. Other URI and URN formats MAY also be used. In particular, URN formats defined in [RFC9039].

Note: Implementations need to be careful when using the Endpoint Client Name to perform database lookups due to the risk of SQL injection attacks.

Note: The URN syntax is specified in [RFC8141] as: "urn:<NID>:<NSS>", <NID> being the namespace identifier, <NSS> being a namespace-specific string. NIDs are registered in an IANA registry: at <https://www.iana.org/assignments/urn->

[namespaces/urn-namespaces.xhtml](#).

Format
<p>UUID URN: Identify a device using a Universally Unique Identifier (UUID). The UUID specifies a valid, hex digit character string as defined in [RFC4122]. The format of the URN is            urn:uuid:#####-####-####-####-#####</p>
<p>OPS URN: Identify a device using the Private Enterprise Number, a Product Class, and a Serial Number as defined in [RFC9039]. The format of the URN is            urn:dev:ops:&lt;PEN&gt;-&lt;ProductClass&gt;-&lt;SerialNumber&gt;            This format uses [RFC5612] Private Enterprise Number which are registered in the IANA registry at <a href="https://www.iana.org/assignments/enterprise-numbers/enterprise-numbers">https://www.iana.org/assignments/enterprise-numbers/enterprise-numbers</a>.</p>
<p>OS URN: Identify a device using the the Private Enterprise Number, a Product Class, and a Serial Number as defined in [RFC9039]. The format of the URN is            urn:dev:os:&lt;PEN&gt;-&lt;SerialNumber&gt;            This format uses [RFC5612] Private Enterprise Number which are registered in the IANA registry at <a href="https://www.iana.org/assignments/enterprise-numbers/enterprise-numbers">https://www.iana.org/assignments/enterprise-numbers/enterprise-numbers</a>.</p>
<p>IMEI URN: Identify a device using an International Mobile Equipment Identifiers [3GPP 23.003]. The format of the URN is defined by [RFC7254] as:            urn:gsma:imei:&lt;Type Approval Code&gt;-&lt;Serial Number&gt;-&lt;Spare&gt;</p>
<p>MEID URN: Identify a device using a Mobile Equipment Identifier. The format of the URN is defined by [RFC8464] as:            urn:3gpp2:meid:&lt;Manufacturer Code&gt;-&lt;Serial Number&gt;</p>

Table: 7.4.1.-1 Endpoint Client Name

The previous versions of this specification were recommending other URN formats for historical reasons. Some are defined in [DMREPPRO] Section 5.5 Identifiers. However these URN formats are not respecting [RFC8141]. The table below lists these formats.

Deprecated Format
<p>OPS URN: Identify a device using the format &lt;OUI&gt;-&lt;ProductClass&gt;-&lt;SerialNumber&gt; as defined in Section 3.4.4 of [TR-069]. The format of the URN is                      urn:dev:ops:&lt;OUI&gt;-&lt;ProductClass&gt;-&lt;SerialNumber&gt;                      Note that [TR-069] does not define an URN format and the NID "dev" was not registered. It is RECOMMENDED to prefer the URN format defined by [RFC9039].</p> <p>OS URN: Identify a device using the format &lt;OUI&gt;-&lt;SerialNumber&gt; as defined in Section 3.4.4 of [TR-069]. The format of the URN is                      urn:dev:os:&lt;OUI&gt;-&lt;SerialNumber&gt;                      Note that [TR-069] does not define an URN format and the NID "dev" was not registered. It is RECOMMENDED to prefer the URN format defined by [RFC9039].</p> <p>IMEI URN: Identify a device using an International Mobile Equipment Identifiers [3GPP 23.003]. The IMEI URN specifies a valid, 15 digit IMEI. The format of the URN is                      urn:imei:#####                      Note that the NID "imei" is not registered. It is RECOMMENDED to prefer the URN format defined by [RFC7254].</p> <p>ESN URN: Identify a device using an Electronic Serial Number. The ESN specifies a valid, 8 digit ESN. The format of the URN is                      urn:esn:#####                      Note that the NID "esn" is not registered.</p> <p>MEID URN: Identify a device using a Mobile Equipment Identifier. The MEID URN specifies a valid, 14 digit MEID. The format of the URN is                      urn:meid:#####                      Note that the NID "meid" is not registered. It is RECOMMENDED to prefer the URN format defined by [RFC8464].</p> <p>IMEI-MSISDN URN: Identify a device using a combination of International Mobile Equipment Identifier [3GPP 23.003] and MSISDN. IMEI is 15 digits and MSISDN is 15 digits. The format of the URN is                      urn:imei-msisdn:#####-#####                      Note that the NID "imei-msisdn" is not registered.</p> <p>IMEI-IMSI URN: Identify a device using a combination of International Mobile Equipment Identifier [3GPP 23.003] and IMSI. IMEI is 15 digits and IMSI is 15 digits. The format of the URN is                      urn:imei-imsi:#####-#####                      Note that the NID "imei-imsi" is not registered.</p> <p>IMEI-ICCID URN: Identify a device using a combination of IMEI and Integrated Circuit Card Identification Number [ISO/IEC 7812-1]. The IMEI is 15 digits long and the ICCID is 19 or 20 digits long. The format of the URN is                      urn:imei-iccid:#####-#####                      Note that the NID "imei-iccid" is not registered.</p> <p>NAI URN: Identify a device using a combination of "Local Identifier@Domain Identifier" [3GPP 23.003]. Further [3GPP 23.003] references RFC 4282, which is replaced by [RFC7542] provides total limit to 63 octets (though allowed length is 253 octets which is not advised in [RFC7542] as it may hinder different systems to accommodate that many octets). The format of the URN is                      urn:extid:#####. 63 octets.                      Note that [RFC7542] does not define an URN format and the NID "extid" is not registered, nor is the NID "nai" wrongly used in the examples of the previous revisions of this specification.                      Examples are:</p> <ol style="list-style-type: none"> <li>1. The NAI 123456789@domain.com is represented as urn:extid:123456789@domain.com</li> <li>2. The NAI user@homerealm.example.net is represented as urn:extid:user@homerealm.example.net</li> </ol>

Table: 7.4.1.-2 Deprecated Endpoint Client Name

### 7.4.2. Reusable Resources

When Objects are designed for a similar purpose, for example Objects for use in network management, or Objects for use in embedded device automation, similar Resources are useful in more than one Object. For example in embedded device automation, Objects for different purposes may contain common Resource types such as digital input, digital output, analogue input, analogue output, dimmer value, unit, min measurement, max measurement, value range etc.

If a Resource can feasibly be re-used with the same meaning in multiple Object definitions, it can be defined as a Reusable Resource ID and registered with [OMNA]. Other Objects may then make use of this Reusable Resource ID in

another Object definition.

The definition of a Reusable Resource and its usage when hosted in an Object specification MUST follow several rules:

- the Name, ID, Operation, Type, Range and Units are frozen characteristics when the Reusable Resource is registered at [OMNA] and cannot not be changed when such a Resource is specified in the definition of a hosting Object.
- the registered Description field of a Reusable Resource is also a frozen characteristic; when extension is required to fit the real need of the Object hosting such a Resource, that extension must be mentioned in the Object specification but outside of the Description field itself; furthermore any extension MUST be compatible with the content of the registered Description field.
- a Reusable Resource is registered without defining "Multiple-Resource", or "Mandatory" characteristics; both characteristics will be determined when such a Resource is specified in the definition of a hosting Object.

Note: The strict guidelines about Reusable Resources, as indicated in the above bullets, are specified to ensure that the definition remains consistent across different implementations. [OMNA] is the only official reference for Reusable Resources to which all implementations should adhere. There is no versioning for a resource definition. Name, ID, Operation, Type, Range, and Units of the Reusable Resource cannot change. In addition, any semantics captured in the Description cannot change. If the existing Reusable Resources need to evolve or are not sufficient, it is recommended to propose a new Reusable Resource.

## 7.5. Data Formats for Transferring Resource Information

The following data formats are defined by the LwM2M Enabler in this section: plain text, opaque, TLV, LwM2M TS 1.0 JSON, CBOR, LwM2M CBOR, SenML JSON, and SenML CBOR. Additionally, the LwM2M Enabler uses the CoRE Link data format defined in [RFC6690].

The LwM2M Server MUST support all data formats, including TLV that was mandatory to support for LwM2M TS 1.0 Clients.

The LwM2M Client MUST support plain text, opaque, and CoRE Link data formats and it SHOULD support at least one of SenML CBOR, SenML JSON, or LwM2M CBOR data formats. In addition, a LwM2M Client MAY choose to support other data formats. LwM2M Clients supporting [LwM2M-TS\_1.1] or newer SHOULD NOT use the legacy TLV or JSON formats.

Messages containing data MUST specify the payload encoding by using one of the supported data formats.

An LwM2M Server data request MAY contain an option specifying the data formats the Server would prefer to receive for the payload; if this data format is not accepted by the LwM2M Client, the request is rejected; if the LwM2M Client doesn't support that option or if the LwM2M Server expresses no data format preference, the LwM2M Client will use its own preferred data format.

The IANA registered Media Types supported in [LwM2M-TS\_1.0] are listed in the table below.

Data Format	IANA Media Type	Numeric Content-Formats [CoAP]
Plain Text	text/plain	0
CoRE Link Format	application/link-format	40
Opaque	application/octet-stream	42
TLV	application/vnd.oma.lwm2m+tlv	11542
JSON	application/vnd.oma.lwm2m+json	11543

Table: 7.5.-1 IANA registered Media Types supported in LwM2M TS 1.0

In addition, [LwM2M-TS\_1.1] adds support for the following standardized media types.

Data Format	IANA Media Type	Numeric Content-Formats [CoAP]
CBOR	application/cbor	60
SenML JSON	application/senml+json	110
SenML CBOR	application/senml+cbor	112

Table: 7.5.-2 Additional standardized Media Types supported in LwM2M TS 1.1

In addition, this specification adds support for the following IANA registered Media Type.

Data Format	IANA Media Type	Numeric Content-Formats [CoAP]
LwM2M CBOR	application/vnd.oma.lwm2m+cbor	11544
SenML-ETCH JSON	application/senml-etch+json	320
SenML-ETCH CBOR	application/senml-etch+cbor	322

Table: 7.5.-3 Additional IANA registered Media Type supported in LwM2M TS 1.2

### 7.5.1. Plain Text

The plain text format is used for "Read" and "Write" operations on singular Resources or Resource Instances where the value of the Resource is represented as described in Section [Appendix C. Data Types \(Normative\)](#).

For example, a request to the example client's Device Object Instance, Manufacturer Resource would return the following plain text payload:

Req: Read /3/0/0
Res: 2.05 Content Open Mobile Alliance

This data format has a Media Type of text/plain.

### 7.5.2. Opaque

The opaque format is used for "Read" and "Write" operations on singular Resources or Resource Instances where the value of the Resource is an opaque sequence of binary octets. This data format is used for binary Resources such as firmware images or application specific binary formats.

This data format has a Media Type of application/octet-stream.

### 7.5.3. CBOR

The Concise Binary Object Representation format is used for "Read" and "Write" operations on singular Resources or Resource Instances.

This data format has a Media Type of application/cbor which covers all the LwM2M data types via the use of its major types with or without optional tags.

### 7.5.4. LwM2M CBOR

When a LwM2M Client is supporting the LwM2M CBOR data format and the format is used to transport resource values for LwM2M operations, LwM2M CBOR payload MUST use the format defined in this section.

This data format has a Media Type of application/vnd.oma.lwm2m+cbor.

The syntax of this data format is as follows:

```
payload = CBOR_map_with_length 1*(ID, VALUE) / CBOR_infinite_map_start 1*(ID, VALUE) CBOR_break
ID = CBOR_unsigned_integer / CBOR_array_with_length 1*(CBOR_unsigned_integer) / CBOR_infinite_array_start 1*(CBOR_unsigned_integer) CBOR_break
VALUE = CBOR_value / payload
```

According to the ABNF syntax above, the values are encoded in a CBOR map (Major type 5). The key of the data items is the ID of the underlying Object, Object Instance, Resource, or Resource Instance. The IDs inside the top-level payload MUST start with the Object ID.

In the LwM2M CBOR payload of the "Create" operation, MAX\_ID 65535 MAY be used to indicate there is no reference to an Object Instance.

#### 7.5.4.1. Single Resource Example

A request to the Device Object on Resource 0 of the LwM2M example client from Appendix F (Read /3/0/0) would return the following LwM2M CBOR payload. This example has a size of 26 bytes.

```
A1      # map(1)
 83     # array(3)
  03    # unsigned(3)
  00    # unsigned(0)
  00    # unsigned(0)
 74     # text(20)
      4F70656E204D6F62696C6520416C6C69616E6365 # "Open Mobile Alliance"
```

The same example using the CBOR diagnostic notation is shown below.

```
{[3, 0, 0]: "Open Mobile Alliance"}
```

Note that the following payload is also valid:

```
A1      # map(1)
 03     # unsigned(3)
 A1     # map(1)
  00    # unsigned(0)
  A1    # map(1)
  00    # unsigned(0)
  74    # text(20)
      4F70656E204D6F62696C6520416C6C69616E6365 # "Open Mobile Alliance"
```

```
{3: {0: {0: "Open Mobile Alliance"}}}
```

#### 7.5.4.2. Multiple Resource Example

A request to the Device Object on Resource 6 of the LwM2M example client from Appendix F (Read /3/0/6) would return the following LwM2M CBOR payload. This example has a size of 10 bytes.

```
A1      # map(1)
 83     # array(3)
  03    # unsigned(3)
  00    # unsigned(0)
  06    # unsigned(6)
 A2     # map(2)
  00    # unsigned(0)
  01    # unsigned(1)
  01    # unsigned(1)
  05    # unsigned(5)
```

The same example using the CBOR diagnostic notation is shown below.

```
{[3, 0, 6]: {0: 1,
1: 5}}
```

### 7.5.4.3. Single Object Instance Example

A request to the Device Object (Read /3/0) of the LwM2M example client would return the following LwM2M CBOR payload. This example has a size of 118 bytes.

```

A1          # map(1)
  82        # array(2)
    03      # unsigned(3)
    00      # unsigned(0)
  AD        # map(13)
    00      # unsigned(0)
    74      # text(20)
      4F70656E204D6F62696C6520416C6C69616E6365 # "Open Mobile Alliance"
    01      # unsigned(1)
    76      # text(22)
      4C69676874776569676874204D324D20436C69656E74 # "Lightweight M2M Client"
    02      # unsigned(2)
    69      # text(9)
      333435303030313233 # "345000123"
    03      # unsigned(3)
    63      # text(3)
      312E30 # "1.0"
    06      # unsigned(6)
  A2        # map(2)
    00      # unsigned(0)
    01      # unsigned(1)
    01      # unsigned(1)
    05      # unsigned(5)
    07      # unsigned(7)
  A2        # map(2)
    00      # unsigned(0)
    19 0ED8 # unsigned(3800)
    01      # unsigned(1)
    19 1388 # unsigned(5000)
    08      # unsigned(8)
  A2        # map(2)
    00      # unsigned(0)
    18 7D   # unsigned(125)
    01      # unsigned(1)
    19 0384 # unsigned(900)
    09      # unsigned(9)
    18 64   # unsigned(100)
    0A      # unsigned(10)
    0F      # unsigned(15)
    0B      # unsigned(11)
  A1        # map(1)
    00      # unsigned(0)
    00      # unsigned(0)
  0D        # unsigned(13)
  1A 5182428F # unsigned(1367491215)
  0E        # unsigned(14)
  66        # text(6)
    2B30323A3030 # "+02:00"
  10        # unsigned(16)
  61        # text(1)
  55        # "U"

```

The same example using the LwM2M CBOR diagnostic notation is shown below.

```

{[3, 0]: {0: "Open Mobile Alliance",
  1: "Lightweight M2M Client",
  2: "345000123",
  3: "1.0",
  6: {0: 1,
    1: 5},
  7: {0: 3800,

```

```

1: 5000},
8: {0: 125,
1: 900},
9: 100,
10: 15,
11: {0: 0},
13: 1367491215,
14: "+02:00",
16: "U"}}

```

#### 7.5.4.4. Multiple Object Instances Example

A request to the LwM2M Server Object (Read /1) of the LwM2M example client would return the following LwM2M CBOR payload. This example has a size of 63 bytes.

```

A1      # map(1)
01      # unsigned(1)
A2      # map(2)
00      # unsigned(0)
A7      # map(7)
00      # unsigned(0)
18 65   # unsigned(101)
01      # unsigned(1)
1A 00015180 # unsigned(86400)
02      # unsigned(2)
19 012C   # unsigned(300)
03      # unsigned(3)
19 1770   # unsigned(6000)
05      # unsigned(5)
1A 00015180 # unsigned(86400)
06      # unsigned(6)
F5      # primitive(21)
07      # unsigned(7)
61      # text(1)
55      # "U"
01      # unsigned(1)
A7      # map(7)
00      # unsigned(0)
18 66   # unsigned(102)
01      # unsigned(1)
1A 00015180 # unsigned(86400)
02      # unsigned(2)
19 0258   # unsigned(600)
03      # unsigned(3)
19 1770   # unsigned(6000)
05      # unsigned(5)
1A 00015180 # unsigned(86400)
06      # unsigned(6)
F4      # primitive(20)
07      # unsigned(7)
61      # text(1)
55      # "U"

```

The same example using the CBOR diagnostic notation is shown below.

```

{1: {0: {0: 101,
1: 86400,
2: 300,
3: 6000,
5: 86400,
6: true,
7: "U"},
1: {0: 102,
1: 86400,
2: 600,

```

```

3: 6000,
5: 86400,
6: false,
7: "U"}}}

```

#### 7.5.4.5. Composite Operation Example

A composite request to the manufacturer name (/3/0/0), battery level(/3/0/9), and registration lifetime (/1/0/1) of the LwM2M example client would return the following LwM2M CBOR payload. This example has a size of 39 bytes.

```

A2          # map(2)
 82         # array(2)
  03       # unsigned(3)
  00       # unsigned(0)
A2         # map(2)
  00       # unsigned(0)
  74       # text(20)
    4F70656E204D6F62696C6520416C6C69616E6365 # "Open Mobile Alliance"
  09       # unsigned(9)
 18 64     # unsigned(100)
83         # array(3)
  01       # unsigned(1)
  00       # unsigned(0)
  01       # unsigned(1)
1A 00015180 # unsigned(86400)

```

The same example using the CBOR diagnostic notation is shown below.

```

{{3, 0}: {0: "Open Mobile Alliance",
          9: 100},
 [1, 0, 1]: 86400}

```

#### 7.5.4.6. Create Operation Example

A Create operation to the LwM2M ACL Object (Create /2) of the LwM2M example client could contain the following LwM2M CBOR payload. This example has a size of 17 bytes.

```

A1          # map(1)
 82         # array(2)
  02       # unsigned(2)
  05       # unsigned(5)
A4         # map(4)
  00       # unsigned(0)
  05       # unsigned(5)
  01       # unsigned(1)
  00       # unsigned(0)
  82       # array(2)
    02     # unsigned(2)
    18 66 # unsigned(102)
  00       # unsigned(0)
  03       # unsigned(3)
 18 65     # unsigned(101)

```

The same example using the CBOR diagnostic notation is shown below.

```

{{2, 5}: {0: 5,
          1: 0,
          [2, 102]: 0,
          3: 101}}

```

In the example above, the LwM2M Server requests the creation of a new Object Instance with ID: 5. To let the LwM2M Client assign the ID of the created Object Instance, the LwM2M CBOR payload could be the following:

```

A1          # map(1)
 82         # array(2)

```

```
02 # unsigned(2)
19 FFFF # unsigned(65535)
A4 # map(4)
00 # unsigned(0)
05 # unsigned(5)
01 # unsigned(1)
00 # unsigned(0)
82 # array(2)
 02 # unsigned(2)
 18 66 # unsigned(102)
00 # unsigned(0)
03 # unsigned(3)
18 65 # unsigned(101)
```

The same example using the CBOR diagnostic notation is shown below.

```
{[2, 65535]: {0: 5,
 1: 0,
 [2, 102]: 0,
 3: 101}}
```

### 7.5.5. TLV

For "Read" and "Write" operations, the binary TLV (Type-Length-Value) format can be used to represent an array of values or a singular value using a compact binary representation, which is easy to process on simple embedded devices. The format has a minimum overhead per value of just 2 bytes and a maximum overhead of 5 bytes depending on the type of Identifier and length of the value. The maximum size of an Object Instance or Resource in this format is 16.7 MB. The format is self-describing, thus a parser can skip TLVs for which the Resource is not known.

This data format has a Media Type of application/vnd.oma.lwm2m+tlv.

The format is an array of the following byte sequence, where each array entry represents an Object Instance, Resource, or Resource Instance:

Field	Format and Length	Description
Type	8-bits masked field: obxxxxxxxx (MSB is the bit following ob) Bit numbering is 0 for the LSB to 7 for the MSB	Bits 7-6: Indicates the type of Identifier.  00= Object Instance in which case the Value contains one or more Resource TLVs 01= Resource Instance with Value for use within a multiple Resource TLV 10= multiple Resource, in which case the Value contains one or more Resource Instance TLVs 11= Resource with Value
		Bit 5: Indicates the Length of the Identifier.  0=The Identifier field of this TLV is 8 bits long 1=The Identifier field of this TLV is 16 bits long
		Bit 4-3: Indicates the type of Length.  00=No length field, the value immediately follows the Identifier field in is of the length indicated by Bits 2-0 of this field 01 = The Length field is 8-bits and Bits 2-0 MUST be ignored 10 = The Length field is 16-bits and Bits 2-0 MUST be ignored 11 = The Length field is 24-bits and Bits 2-0 MUST be ignored
		Bits 2-0: A 3-bit unsigned integer indicating the Length of the Value.
Identifier	8-bit or 16-bit unsigned integer as indicated by the Type field.	The Object Instance, Resource, or Resource Instance ID as indicated by the Type field.
Length	0-24-bit unsigned integer as indicated by the Type field.	The Length of the following field in bytes.
Value	Sequence of bytes of Length	Value of the tag. The format of the value depends on the Resource's data type (See <a href="#">Appendix C. Data Types (Normative)</a> ).

Table: 7.5.5.-1 TLV format and description

Each TLV entry starts with a Type byte that indicates if the TLV contains an Object Instance, a Resource, multiple Resources, or a Resource Instance. Object Instance and Resource with Resource Instance TLVs contains other TLVs in their value. The hierarchy is as follows and may be up to 3 levels deep.

- Object Instance TLV, which contains
  - Resource TLVs or
  - multiple Resource TLVs, which contains
    - Resource Instance TLVs

For simplicity and to prevent any ambiguity on Object Instance Identity, when the Object Instance ID is not specified in the request, the Object Instance TLV MUST be used, whatever the number of Object Instances (1 or more) to return to the LwM2M Server. When the Object Instance ID is specified in the request, the Object Instance TLV is optional.

When a Multiple Resource has to be returned to the LwM2M Server, the Multiple Resource TLV MUST be used whatever the number of Instances (0, 1 or more) of that resource.

[Figure: 7.5.5.-1 TLV nesting](#) illustrates the possible nesting of Object Instance, Resource, multiple Resources, and Resource Instance TLVs. One or several Resource TLVs, and/or one or several multiple Resource TLVs MAY be nested in

an Object Instance TLV. A multiple Resource TLV contains one or several Resource Instance TLVs.

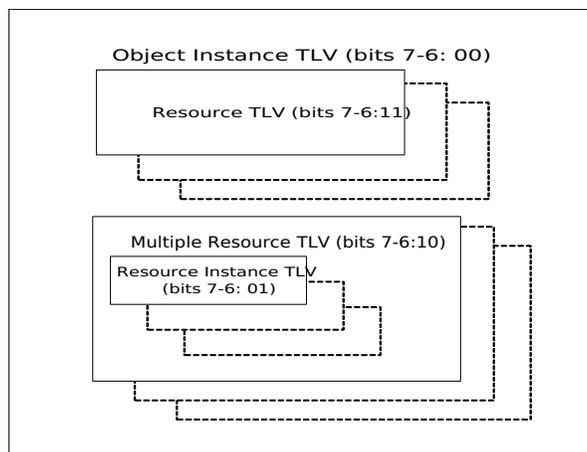

Figure: 7.5.5.-1 TLV nesting

### 7.5.5.1. Single Object Instance Request Example

In this example, a request for the Device Object Instance (ID:3) of an LwM2M Client is made (Read /3/0). The LwM2M Client responds with a TLV payload including all of the readable Resources. This TLV payload would have the following format. The total payload size with the TLV encoding is 121 bytes:

```

C8 00 14 4F 70 65 6E 20 4D 6F 62 69 6C 65 20 41 6C 6C 69 61 6E 63 65
C8 01 16 4C 69 67 68 74 77 65 69 67 74 20 4D 32 4D 20 43 6C 69 65 6E 74
C8 02 09 33 34 35 30 30 30 31 32 33
C3 03 31 2E 30
86 06
 41 00 01
 41 01 05
88 07 08
 42 00 0E D8
 42 01 13 88
87 08
 41 00 7D
 42 01 03 84
C1 09 64
C1 0A 0F
83 0B
 41 00 00
C4 0D 51 82 42 8F
C6 0E 2B 30 32 3A 30 30
C1 10 55

```

TLV	Type Byte	ID Byte(s)	Length Byte(s)	Value	Total Bytes
Manufacturer Resource	0b11 0 01 000	0x00	0x14 (20 bytes)	Open Mobile Alliance [String]	23
Model Number	0b11 0 01 000	0x01	0x16 (22 bytes)	"Lightweight M2M Client" [String]	25
Serial Number	0b11 0 01 000	0x02	0x09 (9 bytes)	"345000123" [String]	12
Firmware Version	0b11 0 00 011	0x03	–	"1.0" [String] (3 bytes)	5
Available Power Sources	0b10 0 00 110	0x06	–	The next two rows (6 bytes)	2
Available Power Sources[0]	0b01 0 00 001	0x00	–	0X01 [8-bit Integer]	3
Available Power Sources[1]	0b01 0 00 001	0x01	–	0X05 [8-bit Integer]	3

Power Source Voltage	0b10 0 01 000	0x07	0x08 (8 bytes)	The next two rows	3
Power Source Voltage[0]	0b01 0 00 010	0x00	–	0X0ED8 [16-bit Integer]	4
Power Source Voltage[1]	0b01 0 00 010	0x01	–	0X1388 [16-bit Integer]	4
Power Source Current	0b10 0 00 111	0x08	–	The next two rows (7 bytes)	2
Power Source Current[0]	0b01 0 00 001	0x00	–	0X7D [8-bit Integer]	3
Power Source Current[1]	0b01 0 00 010	0x01	–	0X0384 [16-bit Integer]	4
Battery Level	0b11 0 00 001	0x09	–	0x64 [8-bit Integer]	3
Memory Free	0b11 0 00 001	0x0A	–	0x0F [8-bit Integer]	3
Error Code	0b10 0 00 011	0x0B	–	The next row (3 bytes)	2
Error Code[0]	0b01 0 00 001	0x00	–	0x00 [8-bit Integer]	3
Current Time	0b11 0 00 100	0x0D	–	0x5182428F [32-bit Integer]	6
UTC Offset	0b11 0 00 110	0x0E	–	" +02:00" [String] (6 bytes)	8
Supported Binding and Modes	0b11 0 00 001	0x10	–	"U" [String] (1 byte)	3
Total					121

Table: 7.5.5.1.–1 Single Object Instance Request Example

### 7.5.5.2. Multiple Object Instance Request Examples

#### A) Request on Single-Instance Object

In this example, a request for the Device Object Instance (ID:3) of an LwM2M Client is made (Read /3). The Device Object is a Single-Instance Object, but the Object Instance TLV is used (to be compared with the example of the previous section).

The LwM2M Client responds with a TLV payload including the Object Instance ID and all its readable Resources. This TLV payload would have the following value (indented for readability) and format. The total payload size with the TLV encoding is 124 bytes:

```

08 00 79
  C8 00 14 4F 70 65 6E 20 4D 6F 62 69 6C 65 20 41 6C 6C 69 61 6E 63 65
  C8 01 16 4C 69 67 68 74 77 65 69 67 74 20 4D 32 4D 20 43 6C 69 65 6E 74
  C8 02 09 33 34 35 30 30 30 31 32 33
  C3 03 31 2E 30
  86 06
    41 00 01
    41 01 05
  88 07 08
    42 00 0E D8
    42 01 13 88
  87 08
    41 00 7D
    42 01 03 84
  C1 09 64
  C1 0A 0F
  83 0B
    41 00 00
  C4 0D 51 82 42 8F
  C6 0E 2B 30 32 3A 30 30
  C1 10 55

```

TLV	Type Byte	ID Byte(s)	Length Byte(s)	Value	Total Bytes
Device Object Instance 0	0b00 0 01 000	0x00	0x79 (121 bytes)	The next 20 rows	3
Manufacturer Resource	0b11 0 01 000	0x00	0x14 (20 bytes)	Open Mobile Alliance [String]	23
Model Number	0b11 0 01 000	0x01	0x16 (22 bytes)	"Lightweight M2M Client" [String]	25
Serial Number	0b11 0 01 000	0x02	0x09 (9 bytes)	"345000123" [String]	12
Firmware Version	0b11 0 00 011	0x03	–	"1.0" [String] (3 bytes)	5
Available Power Sources	0b10 0 00 110	0x06	–	The next two rows (6 bytes)	2
Available Power Sources[0]	0b01 0 00 001	0x00	–	0X01 [8-bit Integer]	3
Available Power Sources[1]	0b01 0 00 001	0x01	–	0X05 [8-bit Integer]	3
Power Source Voltage	0b10 0 01 000	0x07	0x08 (8 bytes)	The next two rows	3
Power Source Voltage[0]	0b01 0 00 010	0x00	–	0X0ED8 [16-bit Integer]	4
Power Source Voltage[1]	0b01 0 00 010	0x01	–	0X1388 [16-bit Integer]	4
Power Source Current	0b10 0 00 111	0x08	–	The next two rows (7 bytes)	2
Power Source Current[0]	0b01 0 00 001	0x00	–	0X7D [8-bit Integer]	3
Power Source Current[1]	0b01 0 00 010	0x01	–	0X0384 [16-bit Integer]	4
Battery Level	0b11 0 00 001	0x09	–	0x64 [8-bit Integer]	3
Memory Free	0b11 0 00 001	0x0A	–	0x0F [8-bit Integer]	3
Error Code	0b10 0 00 011	0x0B	–	The next row (3 bytes)	2
Error Code[0]	0b01 0 00 001	0x00	–	0x00 [8-bit Integer]	3
Current Time	0b11 0 00 100	0x0D	–	0x5182428F [32-bit Integer]	6
UTC Offset	0b11 0 00 110	0x0E	–	"+02:00" [String] (6 bytes)	8
Supported Binding and Modes	0b11 0 00 001	0x10	–	"U" [String] (1 byte)	3
<b>Total</b>					<b>124</b>

Table: 7.5.5.2.-1 Request on Single-Instance Object

## B) Request on Multiple-Instance Object having 2 instances

In this example, a request on the Access Control Object (ID:2) of an LwM2M Client is made (Read /2). The Access Control Object is a Multiple-Instance Object. In this simplified example, it has only 2 instances describing the access rights of two LwM2M Servers with Short IDs 127 and 310 on Objects Instances /1/0 and /3/0.

The LwM2M Client responds with a TLV payload including the 2 Object Instances (ID:0 and ID:2) and their Resources. This TLV payload would have the following value (indented for readability) and format. The total payload size with the TLV encoding is 38 bytes:

```
08 00 0E
  C1 00 01
  C1 01 00
  83 02
  41 7F 07
  C1 03 7F
08 02 12
  C1 00 03
  C1 01 00
  87 02
  41 7F 07
  61 01 36 01
  C1 03 7F
```

TLV	Type Byte	ID Byte(s)	Length Byte(s)	Value	Total Bytes
Access Control Object Instance 0	0b00 0 01 000	0x00	0xE (17 bytes)	The next 5 rows	3
Object ID	0b11 0 00 001	0x00	–	0x01 [8-bit Integer]	3
Object Instance ID	0b11 0 00 001	0x01	–	0x00 [8-bit Integer]	3
ACL	0b10 0 00 011	0x02	–	The next row (3 bytes)	2
<i>ACL [127]</i>	<i>0b01 0 00 001</i>	<i>0x7F</i>	–	<i>0b000 00111</i> [8-bit Integer]	3
Access Control Owner	0b11 0 00 001	0x03	–	0x7F [8-bit Integer]	3
Access Control Object Instance 2	0b00 0 01 000	0x02	0x12 (18 bytes)	The next 6 rows	3
Object ID	0b11 0 00 001	0x00	–	0x03 [8-bit Integer]	3
Object Instance ID	0b11 0 00 001	0x01	–	0x00 [8-bit Integer]	3
ACL	0b10 0 00 111	0x02	–	The next 2 rows	2
<i>ACL [127]</i>	<i>0b01 0 00 001</i>	<i>0x7F</i>	–	<i>0b000 00111</i> [8-bit Integer]	3
<i>ACL [310]</i>	<i>0b01 1 00 001</i>	<i>0x0136</i>	–	<i>0b000 00001</i> [8-bit Integer]	4
Access Control Owner	0b11 0 00 001	0x03	–	0x7F [8-bit Integer]	3
<b>Total</b>					38

Table: 7.5.5.2.-2 Request on Multiple-Instance Object having 2 instances

### C) Request on Multiple-Instance Object having 1 instance only

In this example, a request to the Server Object Instances of an LwM2M Client is performed (Read /1). The Server Object is a Multiple-Instances Object. The LwM2M Client has only one Server Object instance and will respond with a TLV payload including the single Object Instance (o) and their Resources. This TLV payload would have the following value (indented for readability) and format. The total payload size with the TLV encoding is 18 bytes:

```
08 00 0D
  C1 00 01
  C4 01 00 01 51 80
  C1 06 01
  C1 07 55
```

TLV	Type Byte	ID Byte(s)	Length Byte(s)	Value	Total Bytes
Server Object Instance 0	0b00 0 01 000	0x00	0x0D (13 Bytes)	The next 5 rows	3
Short Server ID	0b11 0 00 001	0x00	–	0x01 [8-bit Integer]	2
Lifetime	0b11 0 00 100	0x01	–	86400 [32-bit Integer]	5
Notification Storing When Disabled or Offline	0b11 0 00 001	0x06	–	True [Boolean]	3
Binding	0b11 0 00 001	0x07	–	"U" [String] (1 byte)	3
<b>Total</b>					<b>16</b>

Table: 7.5.5.2.-3 Example, a request to the Server Object Instances of an LwM2M client is performed (Read /1)

### 7.5.5.3. Example of Request on an Object Instance containing an Object Link Resource

Examples are based on the LwM2M Object Tree illustration presented in [Figure: C.-1 Object link Resource simple illustration](#). The TLV format doesn't report the object hierarchy.

Example 1) request to Object 65 Instance 0: Read /65/0

```
88 00 0C
 44 00 00 42 00 00
 44 01 00 42 00 01
C8 01 0D 38 36 31 33 38 30 30 37 35 35 30 30
C4 02 12 34 56 78
```

TLV	Type Byte	ID Byte(s)	Length Byte(s)	Value	Total Bytes
Res o lnk	0b1 0 0 01000	0x00	0x0C(12 bytes)	The next 2 rows	3
Res o lnk [0]	0b01 000 100	0x00	–	0x0042 0000 [Objlnk] (66:0)	6
Res o lnk [1]	0b01 0 00 100	0x01	–	0x0042 0001 [Objlnk] (66:1)	6
Res 1	0b11 0 01 000	0x01	0x0D	"8613800755500" [String] (13 bytes)	16
Res 2	0b11 0 00 100	0x02	–	0x12345678 [32-bit Integer]	6
<b>Total</b>					<b>37</b>

Table: 7.5.5.3.-1 Example 1) Request to Object 65 Instance 0: Read /65/0

Example 2) request to Object 66: Read /66: TLV payload will contain 2 Object Instances

```
08 00 23
C8 00 0B 6D 79 53 65 72 76 69 63 65 20 31
C8 01 0F 49 6E 74 65 72 6E 65 74 2E 31 35 2E 32 33 34
C4 02 00 43 00 00
08 01 23
C8 00 0B 6D 79 53 65 72 76 69 63 65 20 32
C8 01 0F 49 6E 74 65 72 6E 65 74 2E 31 35 2E 32 33 35
C4 02 FF FF FF FF
```

TLV	Type Byte	ID Byte(s)	Length Byte(s)	Value	Total Bytes
Object 66 Instance 0	0b00 0 01 000	0x00	0x23 (35 bytes)	The next 3 rows	3
Res 0	0b11 0 01 000	0x00	0x0B	"myService 1" [String] (11 bytes)	14
Res 1	0b11 0 01 000	0x01	0x0F	"Internet.15.234" [String] (15 bytes)	15
Res 2 lnk	0b11 0 00 100	0x02	–	0x0043 0000 [Objlnk] (67:0)	6
Object 66 Instance 1	0b00 0 01000	0x01	0x23 (35 bytes)	The next 3 rows	3
Res 0	0b11 0 01 000	0x00	0x0B	"myService 2" [String] (11 bytes)	14
Res 1	0b11 0 00 000	0x01	0x0F	"Internet.15.235" [String] (15 bytes)	15
Res 2 lnk	0b11 0 00 100	0x02	–	0xFFFF FFFF [Objlnk] (no link)	6
Total					76

Table: 7.5.3.-2 Example 2) request to Object 66: Read /66: TLV payload will contain 2 Object Instances

## 7.5.6. SenML JSON

When a LwM2M Client is supporting the SenML JSON data format and the format is used to transport Object Instance(s), multiple resource and single resource values for both "Read" and "Write" operations, SenML JSON payload MUST use the format defined in this section. This format MAY be used also for transporting a single value of a Resource.

The format MUST comply to [SENML] JSON representation extended for supporting LwM2M Object Link data type and MUST support all attributes defined in [Table: 7.5.6.-1 SenML JSON format and description](#).

According to [SENML] semantics, the SenML JSON data format is composed of an array of entries (SenML Records) with optional and mandatory fields.

Each entry of the SenML JSON format is a Resource Instance, where the Name attribute need to be prepended by the Base Name attribute to form the unique identifier of this Resource instance.

The Name attribute in an entry is a URI path relative to the Base Name; namely the Name attribute could simply be the full URI path of a requested Resource Instance when Base Name is absent.

The SenML JSON format is useful for transporting multiple Resource Instances for example when transporting all Instances of an Object with all Resources, and Resource Instances within a single LwM2M Client response.

In particular, when Base Name is set to the LwM2M Object root (e.g. "/"), the SenML JSON format may support to return a hierarchy of Object Instances when Object Link datatype resources are reported (example given below). The resource instances tree report is performed in using a Breadth-First traversal strategy (see SenML JSON second example below); a given Object Instance MUST appear at most once in that report. The SenML JSON format also includes optional time fields, which allows for multiple versions of representations to be sent in the same payload or indicating the time when the representation was created (e.g., measurement made).

Note: SenML time values (Base Time and Time) are represented in floating point as seconds and a missing time attribute is considered to have a value of zero. Base time and time are added together. In general, positive time values represent an absolute time relative to the Unix epoch, while negative values represent a relative time in the past from the current

time. For details see [SENML].

Historical version of notifications are typically generated when "Notification Storing When Disabled or Offline" resource of the LwM2M Server Object is set to true (see [Appendix E. LwM2M Objects defined by OMA \(Normative\)](#)) and when the Device comes on line after having been disabled for a period of time.

The SenML JSON data format has a Media Type application/senml+json.

[LwM2M-TS\_1.0] defined the format for application/vnd.oma.lwm2m+json based on an early draft version of SenML. [LwM2M-TS\_1.1] aligned the SenML JSON format with the final version of the SenML specification. However, SenML specification does not define the necessary semantics for its use with LwM2M Read-Composite or Write-Composite operations. This issue was partially resolved by [LwM2M-TS\_1.1] and since its publication, [RFC8790] has formally defined application/senml-etch+json and application/senml-etch+cbor media types and their semantics in line with what was specified in [LwM2M-TS\_1.1].

For backward compatibility, LwM2M Server implementations of [LwM2M-TS\_1.1] MUST support both application/senml+json and application/vnd.oma.lwm2m+json. LwM2M Client implementations of [LwM2M-TS\_1.1] and later MUST NOT use the application/vnd.oma.lwm2m+json format. Furthermore, LwM2M Clients implementing LwM2M TS 1.2 or later that support READ-Composite and/or Write-Composite operations MUST also support either application/senml-etch+json, or application/senml-etch+cbor.

Attributes	JSON Variable	Mandatory?	Description
Base Name	bn	No	The base name string which is prepended to the Name value of the entry for forming a globally unique identifier for the resource.
Base Time	bt	No	The base time which the Time values are relative to.
Name	n	No	The Name value is prepended by the Base Name value to form the name of the resource instance. The resulting name uniquely identifies the Resource Instance from all others. Example: <ul style="list-style-type: none"> <li>• if Base Name is "/", the Array entry Name of the Resource is {Object}/{Object Instance}/{Resource}/{Resource Instance}</li> <li>• When Base Name is not present, the Array entry Name is the full URI of the requested Resource Instance</li> </ul>
Time	t	No	The time of the representation relative to the Base Time in seconds for a notification. Required only for historical representations.
Float Value	v	One value field is mandatory	Value as a JSON float if the Resource data type is Integer, Float, or Time.
Boolean Value	vb		Value as a JSON Boolean if the Resource data type is boolean.
Object Link Value	vlo		Value as a JSON string if the Resource data type is ObjLnk. Format according to <a href="#">Appendix C. Data Types (Normative)</a> (e.g. "10:03").
Opaque Value	vd		For Resource data type "opaque" this holds the Base64 encoded representation of the Resource.
String Value	vs		Value as a JSON string for all other Resource data types.

Table: 7.5.6.-1 SenML JSON format and description

For example, a request to a Device Object (Read /3/0) of the LwM2M example client would return the following SenML JSON payload. This example has a size of 399 bytes.

```
{
  "bn": "/3/0/",
  "n": "o",
  "vs": "Open Mobile Alliance",
  "n": "1",
  "vs": "Lightweight M2M Client",
  "n": "2",
  "vs": "345000123",
  "n": "3",
  "vs": "1.0",
  "n": "6/0",
  "v": "1",
  "n": "6/1",
  "v": "5",
  "n": "7/0",
  "v": "3800",
  "n": "7/1",
  "v": "5000",
  "n": "8/0",
  "v": "125",
  "n": "8/1",
  "v": "900",
  "n": "9",
  "v": "100",
  "n": "10",
  "v": "15",
  "n": "11/0",
  "v": "0",
  "n": "13",
  "v": "1367491215",
  "n": "14",
  "vs": "+02:00",
  "n": "16",
  "vs": "U"
}
```

Table 7.5.6.-2 SenML JSON payload returned from example request to Device Object (Read /3/0)

For example, a notification about a Resource containing multiple historical representations of a Temperature Resource (ID:2) (e.g. Instance ID:1 of hypothetical Object ID 72) could result in the following SenML JSON payload:

```
{
  "bn": "/72/",
  "bt": "25462634",
  "n": "1/2",
  "v": "22.4",
  "t": "-5",
  "n": "1/2",
  "v": "22.9",
  "t": "-30",
  "n": "1/2",
  "v": "24.1",
  "t": "-50"
}
```

Table 7.5.6.-3 SenML JSON payload from example notification about a Resource containing multiple historical representations of a Temperature Resource

For example, a request to Object 65 of the LwM2M example seen in [Figure C.-1 Object link Resource simple illustration](#) (Read /65/0) would return the following SenML JSON payload.

Because the Base Name is specified, the full hierarchy linked to the Instance 0 of Object 65 can be reported in a single response (Object 66 Instance 0 & 1, and Instance 0 of Object 67 are part of the payload). This example has a size of 412 bytes.

```
{
  "bn": "/",
  "n": "65/0/0/0",
  "vlo": "66:0",
  "n": "65/0/0/1",
  "vlo": "66:1",
  "n": "65/0/1",
  "vs": "8613800755500",
  "n": "65/0/2",
  "v": "1",
  "n": "66/0/0",
  "vs": "myService1",
  "n": "66/0/1",
  "vs": "Internet.15.234",
  "n": "66/0/2",
  "vlo": "67:0",
  "n": "66/1/0",
  "vs": "myService2",
  "n": "66/1/1",
  "vs": "Internet.15.235",
  "n": "66/1/2",
  "vlo": "FFFF:FFFF",
  "n": "67/0/0",
  "vs": "85.76.76.84",
  "n": "67/0/1",
  "vs": "85.76.255.255"
}
```

Table 7.5.6.-4 SenML JSON payload returned from example request to Object 65 of the LwM2M example seen on Figure C.-1 Object link Resource simple illustration (Read /65/0)

For example, a request to Device Object on Resource 0 of the LwM2M example client (Read /3/0/0) could return the following SenML JSON payload.

```
{
  "bn": "/3/0/0",
  "vs": "Open Mobile Alliance"
}
```

Table 7.5.6.-5 SenML JSON payload returned from example request to Device Object on Resource 0 of the LwM2M example client (Read /3/0/0)

For example, a Read-Composite operation from a LwM2M Server to the LwM2M Client to read manufacturer name and battery level from the LwM2M Device Object together with the registration lifetime Resource from the LwM2M Server Object will look as follows:

```
{{"n":"/3/0/0"},
 {"n":"/3/0/9"},
 {"n":"/1/0/1"}}
```

Table: 7.5.6.-6 SenML JSON payload in the server request to read manufacturer name, battery level and registration lifetime

In response to the Read-Composite operation above the LwM2M Client will return a SenML JSON payload similar to the one shown below.

```
{{"n":"/3/0/0", "vs":"Open Mobile Alliance"},
 {"n":"/3/0/9", "v":95},
 {"n":"/1/0/1", "v":86400}}
```

Table: 7.5.6.-7 SenML JSON payload in the client response to server request to read manufacturer name, battery level and registration lifetime

For example, a Read-Composite operation from a LwM2M Server to an LwM2M Client to read its Location Object together with Network Bearer, Available Network Bearer and Radio Signal Strength resources in Connectivity Monitoring Object will look as follows:

```
{{"bn":"/4/0/", "n":"o"},
 {"n":"1"},
 {"n":"2"},
 {"bn":"/6/", "n":"o"}}
```

Table: 7.5.6.-8 SenML JSON payload in the server request to read Network Bearer, Available Network Bearer, Radio Signal Strength and Location

Note: As shown above, SenML records used with a Read-Composite operation do not contain any value field while the responses will. Prior to [RFC8790], this implied the need for SenML parsers to be context aware, i.e. to distinguish between SenML records received in Read-Composite operations and responses to such requests. However, media types, application/senml-etch+json and application/senml-etch+cbor, defined in [RFC8790] have removed the requirement for context aware parsing.

For example, a Write-Composite operation by a LwM2M Server to switch off 2 light sources, to dim a 3rd to 20% and to set the thermostat to 18 degrees will have a SenML JSON payload as shown in table below. All lights are controlled by instances of the IPSO Light Control Object (Object ID 3311), while the thermostat is controlled by an instance of the IPSO Set Point Object (Object ID 3308).

```
{{"n":"/3311/0/5850", "vb":false},
 {"n":"/3311/1/5850", "vb":false},
 {"n":"/3311/2/5851", "v":20},
 {"n":"/3308/0/5900", "v":18}}
```

Table: 7.5.6.-9 SenML JSON payload in the server Write-Composite to switch off /3311/0 and /3311/1, while dimming /3311/2

Note: The Write-Composite operation with SenML format in [LwM2M-TS\_1.1] could only be used to add or replace a Resource in a Multiple-Instance Resource as there was no support for use of a "null" value in a SenML record to indicate the deletion of a specific Resource Instance. The media types, application/senml-etch+json and application/senml-etch+cbor, defined in [RFC8790] post LwM2M v1.1 have removed this constraint.

The following example shows a Read-Composite operation from a LwM2M Server to the LwM2M Client to read all

objects. This example offers the same functionality as a Read operation for all objects. Note that a response may not return all objects on the LwM2M Client since access control settings have to be taken into account as well.

```
{{"n":"/"}}
```

Table: 7.5.6.-10 SenML JSON payload in the request to all objects

Next we show an example of a Read-Composite operation issued by a LwM2M Server to the LwM2M Client to read all object instances of the LwM2M Server Object.

```
{{"n":"/1"}}
```

Table: 7.5.6.-11 SenML JSON payload in the request to all object instances of the LwM2M Server Object

The final example illustrates how to request all Resources in the first and the third instance of the LwM2M Server Object using a Read-Composite operation issued by a LwM2M Server to the LwM2M Client.

```
{{"n":"/1/0"},  
{"n":"/1/2"}}
```

Table: 7.5.6.-12 SenML JSON payload in the request to all resources of the first and third instance of the LwM2M Server Object

### 7.5.6.1. LwM2M TS 1.0 JSON format

The JSON format used by [LwM2M-TS\_1.0] with media type application/vnd.oma.lwm2m+json is formally defined in [LwM2M-TS\_1.0]. The JSON payload shown below is an example reply to a request to the Device Object of the LwM2M example Client ("Read /3/0").

```
{"bn":"/3/0/",  
  "e":  
  [{"n":"0","sv":"Open Mobile Alliance"},  
   {"n":"1","sv":"Lightweight M2M Client"},  
   {"n":"2","sv":"345000123"},  
   {"n":"3","sv":"1.0"},  
   {"n":"6/0","v":1},  
   {"n":"6/1","v":5},  
   {"n":"7/0","v":3800},  
   {"n":"7/1","v":5000},  
   {"n":"8/0","v":125},  
   {"n":"8/1","v":900},  
   {"n":"9","v":100},  
   {"n":"10","v":15},  
   {"n":"11/0","v":0},  
   {"n":"13","v":1367491215},  
   {"n":"14","sv":"+02:00"},  
   {"n":"16","sv":"U"}]  
}
```

## 7.5.7. SenML CBOR

When a LwM2M Client is supporting the SenML CBOR data format and that format is used to transport Object Instance(s), multiple resource and single resource values for both "Read" and "Write" operations, the SenML CBOR payload MUST use the format defined in Section 6 of [SENML]. The same format MAY be used for transporting a single value of a Resource. The object links use a string map key "vlo" also in SenML CBOR representation.

The example from [Table: 7.5.6.-2 SenML JSON payload returned from example request to Device Object \(Read /3/0\)](#) is

shown below in the SenML CBOR format.

```
90 a3 21 65 2f 33 2f 30 2f 00 61 30 03 74 4f 70
65 6e 20 4d 6f 62 69 6c 65 20 41 6c 6c 69 61 6e
63 65 a2 00 61 31 03 76 4c 69 67 68 74 77 65 69
67 68 74 20 4d 32 4d 20 43 6c 69 65 6e 74 a2 00
61 32 03 69 33 34 35 30 30 30 31 32 33 a2 00 61
33 03 63 31 2e 30 a2 00 63 36 2f 30 02 01 a2 00
63 36 2f 31 02 05 a2 00 63 37 2f 30 02 19 0e d8
a2 00 63 37 2f 31 02 19 13 88 a2 00 63 38 2f 30
02 18 7d a2 00 63 38 2f 31 02 19 03 84 a2 00 61
39 02 18 64 a2 00 62 31 30 02 0f a2 00 64 31 31
2f 30 02 00 a2 00 62 31 33 02 1a 51 82 42 8f a2
00 62 31 34 03 66 2b 30 32 3a 30 30 a2 00 62 31
36 03 61 55
```

For details see [Table: 7.5.6.-2 SenML JSON payload returned from example request to Device Object \(Read /3/o\)](#).

The same example using the SenML CBOR diagnostic notation is shown below.

```
[{-2: "/3/0/", 0: "0", 3: "Open Mobile Alliance"},
{0: "1", 3: "Lightweight M2M Client"},
{0: "2", 3: "345000123"},
{0: "3", 3: "1.0"},
{0: "6/0", 2: 1},
{0: "6/1", 2: 5},
{0: "7/0", 2: 3800},
{0: "7/1", 2: 5000},
{0: "8/0", 2: 125},
{0: "8/1", 2: 900},
{0: "9", 2: 100},
{0: "10", 2: 15},
{0: "11/0", 2: 0},
{0: "13", 2: 1367491215},
{0: "14", 3: "+02:00"},
{0: "16", 3: "U"}]
```

## 8. Access Control

When a LwM2M Client interacts with multiple LwM2M Servers there is a need to determine which operation on a certain Object or Object Instance is authorized for which LwM2M Server. The Access Control Object has been designed to offer this access management capability.

An LwM2M Client can be implemented and configured in two ways:

- In the "Access Control-Enabled" configuration the LwM2M Client is capable of granting access rights to one or several LwM2M Servers. When a LwM2M Client is connected to multiple LwM2M Servers in this configuration then the Access Control Object MUST be instantiated unless all LwM2M Servers are granted full access rights on all Objects and Object Instances in the LwM2M Client.
- In the "Access Control-Disabled" configuration the LwM2M Client is only able to interact with a single LwM2M Server. Hence, the capability to manage access rights for multiple LwM2M Servers is not supported, i.e., the Access Control Object is not instantiated. In this configuration the LwM2M Server implicitly has full access rights on all Objects and Object Instances in the LwM2M Client. The Access Control Object need not be instantiated when a LwM2M Client is connected to a single LwM2M Server (i.e., a single LwM2M Server Account exists in the LwM2M Client).

Subsequent sections use the terms "Access Control-Enabled" and "Access Control-Disabled" to refer to these two types of configurations.

### 8.1. Access Control Object

#### 8.1.1. Access Control Object Overview

In the presence of several LwM2M Servers, there is a need to determine if a certain LwM2M Server is authorized to instantiate a supported Object in the LwM2M Client. Provisioning the necessary authorization policies can only be done by the LwM2M Bootstrap-Server.

Furthermore, the LwM2M Client needs to determine – per supported Object Instance – who the "Access Control Owner" of that Object Instance is and which access rights have been granted to other LwM2M Servers for that Object Instance.

The Access Control Object is specified in Section [LwM2M Object: Access Control](#) and examples are presented in [Appendix F. Example LwM2M Client \(Informative\)](#).

#### 8.1.2. Access Control Object Management

##### *8.1.2.1. Access Control on Object*

To authorize a LwM2M Server to instantiate a certain Object supported by the LwM2M Client, not only an Access Control Object Instance – as defined in Section [Table: 8.1.2.1.-1 Access Control on Object](#) – MUST be associated to such an Object, but this AC Object Instance MUST also contained an ACL Resource Instance targeting the authorized LwM2M Server.

This kind of Access Control Object Instance associated with a certain Object, MUST only be created or updated during a Bootstrap Phase. The absence of such an association for a certain Object, prevents this Object to be instantiated by any LwM2M Server.

When such an Access Control Object Instance already exists for a certain Object, this Access Control Object Instance MAY be updated for supporting additional LwM2M Servers; in that case a new ACL Instance per Server is created in that Access Control Object Instance with the Short Server ID of the LwM2M Server as index of this new ACL Instance, and with the "Create" ("C") access right as ACL Resource value.

Resource ID	Resource Name	Value
0	Object ID	ID of the targeted Object
1	Object Instance ID	MAX_ID=65535 (meaning: Access Control Object Instance is for the Object Level)
2	ACL	A Resource Instance per LwM2M Server authorized to instantiate the Object 5 <sup>th</sup> LSB: "Create" is only configured
3	Access Control Owner	MAX_ID=65535 (meaning: managed by Bootstrap Interface)

Table: 8.1.2.1.-1 Access Control on Object

### 8.1.2.2. Access Control on Object Instance

For being able to register which operations MAY be performed on an Object Instance by a certain LwM2M Server, this Object Instance MUST be associated to an Access Control Object Instance as defined in Section [Table: 8.1.2.2.-1 Access Control on Object Instance](#).

This kind of Access Control Object Instance associated with a certain Object Instance, MAY be created or updated either during a Bootstrap Phase or through the Device Management and Service Enablement Interface.

In particular:

- when a LwM2M Server creates under authorization an Object Instance (see Section [8.2. Authorization](#)) in the LwM2M Client, an Access Control Object Instance MUST be created in the LwM2M Client with the Resources values which MUST be set as given in the table just below. The Access Control Owner Resource is configured with the Short Server ID of the LwM2M Server.

Resource ID	Resource Name	Value
0	Object ID	ID of the targeted Object
1	Object Instance ID	ID of the newly created Object Instance
2	ACL	Any combination of the Access Right {none,R,W,E,D} is acceptable ( <a href="#">LwM2M Object: Access Control</a> )
3	Access Control Owner	The Short Server ID of the LwM2M Server owner of the associated Object Instance

Table: 8.1.2.2.-1 Access Control on Object Instance

- when this Access Control Object Instance is created during the Bootstrap Phase, ACL(s) and Access Control Owner MUST be set with values respecting the consistency of the LwM2M Client configuration.
- through the Device Management and Service Enablement Interface, an Access Control Object Instance MUST only be managed by the LwM2M Server declared as the "Access Control Owner" in it.
- when the LwM2M Server - which is the "Access Control Owner" - adds or modifies (using "Write" operation) access right on the Object Instance for a certain LwM2M Server,
  1. an ACL Resource having the targeted Short Server ID as ACL Resource Instance ID, has to be instantiated by the LwM2M Client if ACL Resource Instance for the LwM2M Server doesn't exist yet
  2. the appropriate access right (R,W,D,E) for that targeted Server on the Object Instance has to be set as ACL Resource Instance value
- A specific ACL Resource Instance MAY be used to grant access rights to LwM2M Servers (except the one defined as the Access Control Owner) which don't have their own ACL Resource Instance. The ID of this ACL Resource Instance containing the default access rights MUST be 0.
- when an Object Instance is removed via "Delete" operation performed by the LwM2M Server which is the "Access Control Owner", the associated Access Control Object Instance MUST be removed by the LwM2M Client.

[Figure: 8.1.2.2.-1 Illustration of the relations between the LwM2M Access Control Object and the other LwM2M Objects](#) illustrates the Access Control Management of an Object Instance (/X/2) supported by a LwM2M Client. An Access Control Object Instance (/2/Y) is declared in ② which defines the Access Rights applicable to the Instance 2 of the Object X pointed in ①.

In this Access Control Object Instance ②, 4 Instances of the ACL Resource are defined:

- ACL Instance 101 contains the operations granted to the Server having 101 as Short ID (Instance ID:2 of the Server Object ID:1 as pointed in ③)
- ACL Instance 22 contains the operations granted to the Server having 22 as Short ID
- ACL Instance 31 contains the operations granted to the Server having 31 as Short ID
- ACL Instance 0 contains the operations granted by default to any Server for which a specific ACL Instance is not defined in this Instance of the Access Control Object (default Access Rights).

This Access Control Object Instance ② also contains a reference to a Server (Access Control Owner) which is the only one Server authorized to manage that Instance of the Access Control Object.

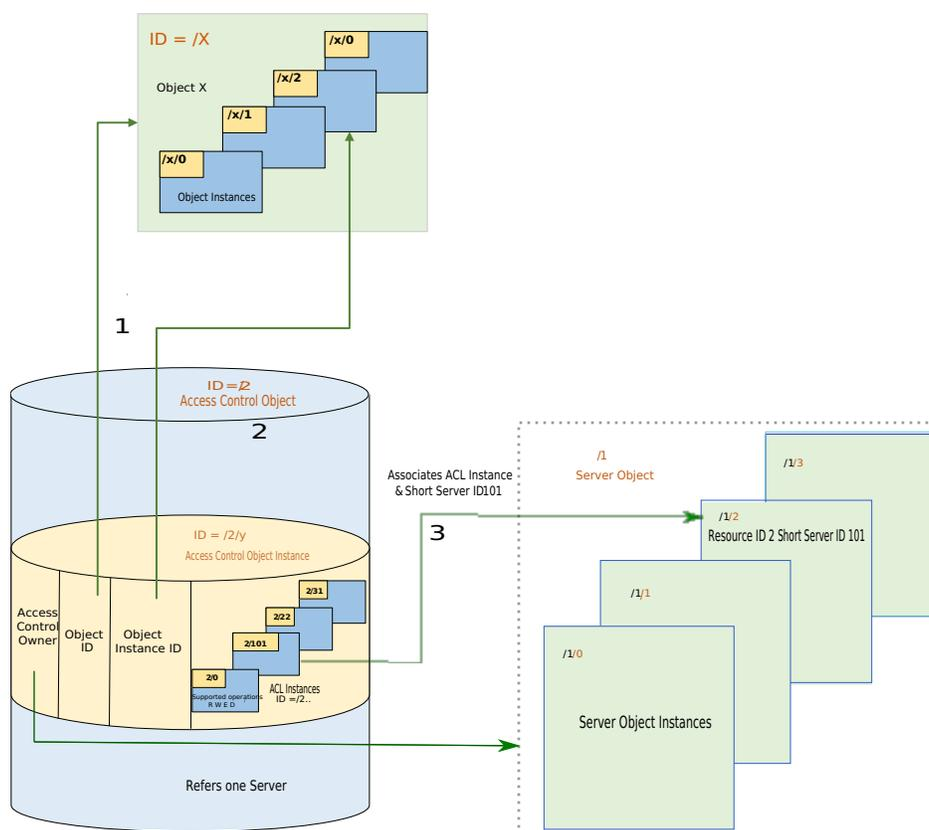

Figure: 8.1.2.2.-1 Illustration of the relations between the LwM2M Access Control Object and the other LwM2M Objects

### 8.1.3. LwM2M Access Control Context Switch

In an "Access Control-Disabled" context, the Access Control Object is not instantiated. In that case, adding a new LwM2M Server Account, requires the LwM2M Client to switch from the current "Access Control-Disabled" context to an "Access Control-Enabled" context which means the Access Control Object MUST be instantiated. This context switch must be managed in a Bootstrap Phase.

Note: The "Bootstrap-Discover" operation allows to retrieve data regarding the configuration of the initial "Access Control-Disabled" context (list of Objects, Object Instances and Short Server IDs). The Bootstrap-Server has then all

information to setup a proper "Access Control-Enabled" context from the initial context one.

## 8.2. Authorization

For authorizing an operation to proceed on Object Instance(s) or Resource(s), the LwM2M Client MUST:

1. obtain the access rights for the involved Object Instances:
  - in "Access Control-Disabled" context, full access rights are granted to the LwM2M Server
  - in "Access Control-Enabled" context, access rights MUST be granted to the LwM2M Server according to Section [8.2.1. Obtaining Access Right](#)
2. check if that access rights granted to the Server are sufficient for the requested operation according to [Table: 8.2.-1 Authorization](#)
3. verify –when the check in 2. on access rights is successful– if the requested operation is supported by the targeted Resource(s) (details are provided in Section [8.2.2. Operation on Resource\(s\) and Object Instance\(s\)](#) and Section [8.2.3. Operation on Object](#)).

The LwM2M Object specification defines which operations are allowed to be performed on Resource within an Object Instance, see supported operations in Section [Appendix D. LwM2M Object Template and Guidelines \(Normative\)](#). The operations allowed on a given Resource MUST apply to all the Resource Instances of that Resource.

LwM2M Operations	Minimum Access Right
READ – READ-COMPOSITE – OBSERVE – OBSERVE-COMPOSITE – WRITE-ATTRIBUTE	R
WRITE – WRITE-COMPOSITE	W
DISCOVER	–
DELETE	D
EXECUTE	E

Table: 8.2.-1 Authorization

### 8.2.1. Obtaining Access Right

In "Access Control-Disabled" context, the LwM2M Server get full access rights.

In "Access Control-Enabled" context:

- for "Create" operation sent by the LwM2M Server, the LwM2M Client MUST get the access right from the ACL Resource Instance corresponding to this LwM2M Server and located in the Access Control Object Instance associated to the targeted Object. Such an Access Control Object Instance – if it exists – has been provisioned during a Bootstrap Phase (Access Control Owner is MAX\_ID=65535). If this access right does not have the "Create" value, or cannot be obtained, the LwM2M Server has no access right.
- For operations, except the "Create" operation, the LwM2M Client MUST retrieve the Access Control Object Instance associated with the Object Instance the LwM2M Server has requested access to, and MUST proceed according to the sequence below:
  1. If the LwM2M Server is declared as the Access Control Owner of this Object Instance and there is no ACL Resource Instance for that LwM2M Server, then the LwM2M Client gets full access right.
  2. If the LwM2M Client has an ACL Resource Instance for the LwM2M Server, the LwM2M Client gets the access right from that ACL Resource Instance.
  3. If the LwM2M Server is not declared as the Access Control Owner of this Object Instance and the LwM2M Client does not have the ACL Resource Instance for that Server, the LwM2M Client gets the access right from the ACL Resource Instance (ID:0) containing the default access rights if it exists (Section [8.1.2.2. Access Control on Object Instance](#)).

4. If the LwM2M Client does not have the ACL Resource Instance ID:0 containing the default access rights, then the LwM2M Server has no access rights.
5. In case of a Composite operation (Read-Composite, Write-Composite, Observe-Composite), the previous four conditions apply to determine the access right for any Object Instance targeted by the Composite Operation. Composite operations have additional characteristics to determine the final access right granted to the LwM2M Server:
  - due to the atomic nature of the Write-Composite operation, all Object Instances involved in that operation MUST have the "Write" access right granted to the requesting LwM2M Server to establish that the "Write" access right is globally granted to such a LwM2M Server for that operation; otherwise, the LwM2M Server has no access right granted.
  - due to the non-atomic nature of the Read-Composite and Observe-Composite operations, any Object Instance involved in the requested operation which has no "Read" access right granted to the requesting LwM2M Server MUST be ignored. If at least one of the Object Instances involved in the requested operation has a "Read" access right granted to the LwM2M Server, the "Read" access right is globally granted to such a LwM2M Server for that operation; otherwise the LwM2M Server has no access right granted.

### 8.2.2. Operation on Resource(s) and Object Instance(s)

When the LwM2M Server targets Resource(s) or Object Instance(s) in a operation, the LwM2M Client MUST obtain an access right for that Server on the Object Instance(s) involved in that operation according to Section [8.2.1. Obtaining Access Right](#). The LwM2M Client MUST then check if the access right is granted prior to performing the requested operation. If the operation is not permitted, the LwM2M Client MUST send an "Unauthorized" error code to the LwM2M Server.

If the operation is permitted, for the "Read-Composite" and "Observe-Composite" operations, and for all Object Instances which have not been ignored during the access right determination (see Section [8.2.1. Obtaining Access Right](#)), the LwM2M Client MUST retrieve all the requested Resources supporting the "Read" operation and sends such retrieved Resource(s) information to the LwM2M Server.

### 8.2.3. Operation on Object

When the LwM2M Server targets an Object for the "Create" operation, the LwM2M Client MUST obtain an access right for the LwM2M Server of the Object according to Section [8.2.1. Obtaining Access Right](#) and MUST check if the access right is granted prior to perform the requested operation.

No access rights are needed for the "Discover" operation on an Object, i.e. the LwM2M Client MUST perform the operation.

For the "Read" and "Observe" operations, the LwM2M Client MUST obtain the access right for the LwM2M Server on each Object Instance according to Section [8.2.1. Obtaining Access Right](#) and the LwM2M Client MUST retrieve all the Object Instances for which the LwM2M Server has the "Read" access right. For each of these qualified Object Instances, the LwM2M Client MUST retrieve all Resources except the Resources which do not support the "Read" operation. The LwM2M Client MUST then aggregate the information produced by the operation on each of these Object Instances individually and then send it to the LwM2M Server.

For the "Write-Attributes" operation, the LwM2M Client MUST perform the operation.

### 8.2.4. Notify Operation Consideration

If the LwM2M Client needs to send a "Notify" operation containing an Object Instance or a Resource to the LwM2M Server, the LwM2M Client MUST check if the LwM2M Server is authorized for the "Read" operation. If the LwM2M Server is not authorized, the Client MUST NOT send the "Notify" operation.

## Appendix A. Change History (Informative)

### A.1 Approved Version History

Reference	Date	Description
OMA-TS-LightweightM2M_Core-V1_1-20180710-A	10 Jul 2018	Status changed to Approved by DMSE WG on 10 Jul 2018.
OMA-TS-LightweightM2M_Core-V1_1_1-20190617-A	17 Jun 2019	Status changed to Approved by DMSE WG on 17 Jun 2019.
OMA-TS-LightweightM2M_Core-V1_2-20201110-A	10 Nov 2020	Status changed to Approved by DMSE WG on 10 Nov 2020.
OMA-TS-LightweightM2M_Core-V1_2_1-20221209-A	09 Dec 2022	Status changed to Approved by DMSE WG on 09 Dec 2022.
OMA-TS-LightweightM2M_Core-V1_2_2-20240613-A	13 Jun 2024	Status changed to Approved by DMSE WG on 13 Jun 2024.

Table: A.1-1 Approved Version History

## Appendix B. Static Conformance Requirements

This appendix is voided.

## Appendix C. Data Types (Normative)

This appendix defines the data types that a Resource can be defined to be.

Data Type	Description
String	A UTF-8 string, the minimum and/or maximum length of the String MAY be defined.
Integer	An 8, 16, 32 or 64-bit signed integer. The valid range of the value for a Resource SHOULD be defined. This data type is also used for the purpose of enumeration.
Unsigned Integer	An 8, 16, 32 or 64-bit unsigned integer. The valid range of the value for a Resource SHOULD be defined. This data type may also be used as a bitmask whereby bit positions range from 0 to $\text{sizeof}(\text{unsigned integer})-1$ . For example, an 8-bit unsigned integer can hold a bitmask of 8 "features" ranging from bit(0) to bit(7) whereby each bit position, when set, corresponds to the unsigned integer value $2^{\text{bit position}}$ . The following example shows an 8-bit unsigned integer value illustrating a bitmask with "0001 0010" whereby bit(1) and bit(4) are set resulting in the unsigned integer value 18 (i.e., $2^1+2^4$ ).
Float	A 32 or 64-bit floating point value. The valid range of the value for a Resource SHOULD be defined.
Boolean	An 8-bit unsigned integer with the value 0 for False and the value 1 for True.
Opaque	A sequence of binary octets, the minimum and/or maximum length of the String MAY be defined.
Time	Unix Time. A signed integer representing the number of seconds since Jan 1 <sup>st</sup> , 1970 in the UTC time zone.
Objlnk	Object Link. The object link is used to refer to an Instance of a given Object. An Object Link referencing no Object Instance will contain 2 MAX-ID values (null link).
Corelnk	CoRE Link. A link is used to refer to Resources on a LWM2M Client and their attributes as specified in [RFC6690].
none	No specific data type affected to that resource: it exclusively concerns Executable Resource.

Table: C.-1 Data Types

An Object Link referencing no Object Instance will contain 2 MAX-ID values (null link).

Data Type	Text Format	TLV Format	SenML JSON Format	CBOR, LwM2M CBOR, and SenML CBOR Formats
String	Represented as a UTF-8 string.	Represented as a UTF-8 string of Length bytes.	Represented as a string.	Represented as a UTF-8 text string, as defined in Section 3 of [RFC8949].
Integer	Represented as an ASCII signed integer. For example, the integer value -750 results in the 4 characters/byte long ASCII string "-750".	Represented as a binary signed integer in network byte order, and in two's complement representation. The value may be 1 (8-bit), 2 (16-bit), 4 (32-bit) or 8 (64-bit) bytes long as indicated by the Length field. When transmitted over network, the data is represented in network byte order (big endian).	Represented as a number.	Represented as an integer, as defined in Section 3 of [RFC8949].
Unsigned Integer	Represented as an ASCII unsigned integer. For example, the unsigned integer value 18 results in a 2 character/byte long ASCII string "18".	Represented as a binary unsigned integer in network byte order. The value may be 1 (8-bit), 2 (16-bit), 4 (32-bit) or 8 (64-bit) bytes long as indicated by the Length field. When transmitted over network, the data is represented in network byte order (big endian).	Represented as a number.	Represented as an unsigned integer, as defined in Section 3 of [RFC8949].

<b>Float</b>	<p>Represented as an ASCII signed numeric representation.</p> <p>For example, we use a floating point number with the significand of 6.667, a base of 10 and the exponent of -11. This represents the number 6.667e-11 in scientific notation and will be represented as "0.0000000006667" as an ASCII string.</p>	<p>Represented as a binary floating point value [FLOAT]. The value may use the binary32 (4 byte length) or binary64 (8 byte length) format as indicated by the Length field. When transmitted over network, the data is represented in network byte order (big endian).</p>	<p>Represented as a number.</p>	<p>Represented as a floating-point number, as defined in Section 3 and Section 3.3 of [RFC8949].</p>
<b>Boolean</b>	<p>Represented as the ASCII value 0 or 1.</p>	<p>Represented as an 8 bit unsigned Integer with value 0, or 1. The Length of a Boolean value MUST always be 1 byte.</p>	<p>Represented as the JSON boolean data type, which is either represented as the string 'true' or 'false'.</p>	<p>Represented as the value 'True' or 'False', as defined in Table 4 of [RFC8949].</p>
<b>Opaque</b>	<p>Represented as a Base64 encoding of the binary data [RFC4648].</p> <p>For example, the sequence of bytes (in hex notation) {0x01, 0x02, 0x03, 0x04, 0x05} converts to the ASCII string "AQIDBAU=" in Base64 encoding.</p>	<p>Represented as a sequence of binary data of Length bytes.</p>	<p>Represented as a URL-safe Base64 encoded representation of the data with padding omitted in a JSON string, as defined in Section 4.3 of [SENML].</p>	<p>Represented as a byte string, as defined in Section 3 of [RFC8949].</p>
<b>Time</b>	<p>Represented as an ASCII integer.</p> <p>For example, 1476186613 seconds since Jan 01 1970, which represents Tuesday, 11-Oct-16 11:50:13 UTC, are represented as the ASCII string "1476186613", which has 10 characters/bytes.</p>	<p>Same representation as Integer.</p>	<p>Represented as a number.</p>	<p>Represented as an unsigned integer or a date/time string, as defined in Section 3.4.1 and Section 3.4.2 of [RFC8949].</p>
<b>Objlnk</b>	<p>Represented as a UTF-8 string containing 2 16-bit ASCII integers separated by a ':' ASCII character. The first one represents the Object ID, and the second one represents the Object Instance ID.</p>	<p>Represented as two concatenated 16 bit unsigned integers following the Network Byte Order convention. The first one represents the Object ID, and the second one represents the Object Instance ID. This value is always 4 bytes long.</p>	<p>Represented as a string containing two 16-bit ASCII integers separated by a ':' ASCII character. The first one represents the Object ID, and the second one represents the Object Instance ID.</p>	<p>Represented as a string containing two 16-bit ASCII integers separated by a ':' ASCII character. The first one represents the Object ID, and the second one represents the Object Instance ID.</p>
<b>Corelnk</b>	<p>Represented as a String using CoRE Link format. For example, an IPSO temperature sensor with measurements query for a resource, with a resource attribute greater than 23: ;gt=23 If the Corelnk refers to an Instance of a given Object (as an Objlnk), then the same validity check as with Objlnk is required.</p>	<p>Same representation as String.</p>	<p>Represented as a string using the CoRE Link format.</p>	<p>Represented as a UTF-8 text string, as defined in Section 3 of [RFC8949].</p>
<b>none</b>	<p>Not applicable</p>	<p>Not applicable</p>	<p>The value is either represented as a string 'null' or as an empty field.</p>	<p>Represented as the value 'Null', as defined in Table 4 of [RFC8949].</p>

Table C.-2 Data Type Mapping

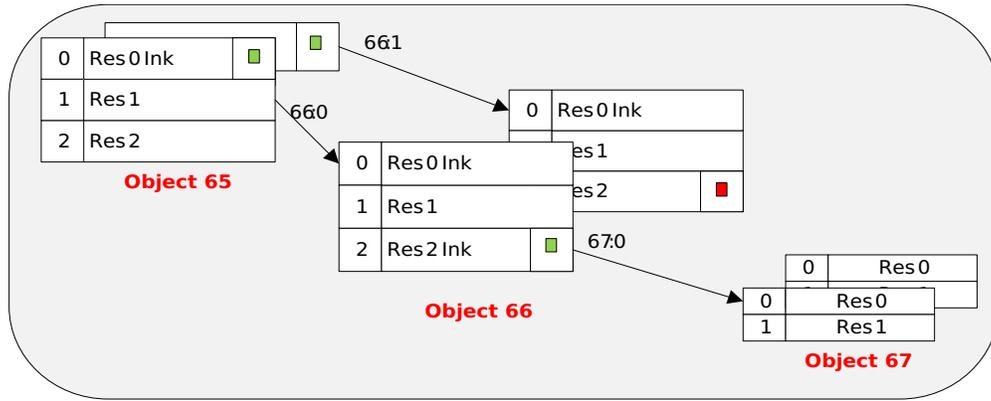

Figure: C.-1 Object link Resource simple illustration

## Appendix D. LwM2M Object Template and Guidelines (Normative)

This appendix provides the template to be used for the specification of LwM2M Objects. Furthermore, guidelines for the creation of LwM2M Objects are provided.

The XML versions of LwM2M Objects MUST comply with one of the approved XML schema files:

<http://openmobilealliance.org/tech/profiles/LWM2M.xsd> or [http://openmobilealliance.org/tech/profiles/LWM2M-v1\\_1.xsd](http://openmobilealliance.org/tech/profiles/LWM2M-v1_1.xsd).

### D.1 Object Template

Appendix LwM2M Object: <*LwM2M object name*>

Description

Object definition:

Name	Object ID	Object Version	LWM2M Version
Object Name	16-bit Unsigned Integer	Object version, e.g.: 1.0	LwM2m version, e.g.: 1.1
Object URN		Instances	Mandatory
urn:oma:lwm2m:{oma,ext,x}:{Object ID}:{version}		Multiple/Single	Mandatory/Optional

Table: D.1-1 Object definition

- **Name:** specifies the Object name.
- **Object ID:** specifies the Object ID.
- **Object Version:** specifies the version of the Object. The first version of an Object must be version "1.0".
- **LWM2M Version:** specifies the version of the LwM2M protocol, e.g. version "1.1".
- **Instances:** indicates whether this Object supports multiple Object Instances or not. If this field is "Multiple" then the number of Object Instance can be from 0 to many. If this field is "Single" then the number of Object Instance can be from 0 to 1. If the Object field "Mandatory" is "Mandatory" and the Object field "Instances" is "Single" then, the number of Object Instances MUST be 1.
- **Mandatory:** if this field is "Mandatory", then the LwM2M Client MUST support this Object. If this field is "Optional", then the LwM2M Client SHOULD support this Object.
- **Object URN:** specifies the Object URN. The format of the Object URN is "urn:oma:lwm2m:{oma,ext,x}:{Object ID}:{version}" and {} part means that those values are variable and filled with real value. For example, the Object URN of the LwM2M Server Object is "urn:oma:lwm2m:oma:1". The "version" field, follows the rules specified in Section 6.2 related to Object Versioning Policy.

## Resource definition:

ID	Name	Operations	Instances	Mandatory	Type	Range or Enumeration	Units	Description
0	Resource Name	R (Read), W (Write), E (Execute)	Multiple/Single	Mandatory/Optional	String, Integer, Unsigned Integer, Float, Boolean, Opaque, Time, Objlnk Corelnk none	If any	If any	Description

Table: D.1-2 Resource definition

- **ID:** specifies the Resource ID, which is unique within an Object or globally unique in case of Reusable Resources.
- **Name:** specifies the Resource name.
- **Operations:** indicates which operations the Resource supports in the given interface. This field can be set to a combination of Read (R), Write (W), and Execute (E). The Execute Operation cannot be used together with the Read and Write operations. This field may also have an empty value, which means that this field can only be accessed by the "Bootstrap" interface. More information about the interfaces and their operations can be found in Section [6. Interfaces](#).
- **Instances:** indicates whether this Resource supports multiple Resource Instances or not. If this field is "Multiple" then the number of Resource Instance can be from 0 to many. If this field is "Single" then the number of Resource Instance can be from 0 to 1. If the Resource field "Mandatory" is "Mandatory" and the field "Instances" of the Resource is "Single" then, the number of Resource Instance MUST be 1. A Resource, which supports the "Execute" operation, MUST have "Single" as value of the "Instances" field.
- **Mandatory:** if this field is "Mandatory", then any Instance of the Object that Resource belongs to, MUST instantiate such a Resource (refer Section 6.1, Resource Model). If this field is "Optional", then this Resource MAY be omitted from some – or even all – Instances of the Object that Resource belongs to.
- **Type:** Data Type indicates the type of Resource value. Data Types used in this enabler are described in Appendix C Data Types. A Resource, which supports the "Execute" operation, MUST have no associated Data Type (none) encoded as an empty value in Object DDF file.
- **Range or Enumeration:** this field limits the possible values of a Resource. A range is defined using two numeric values separated by two dots (".") to indicate the lower and upper limits (inclusive). Enumeration is defined using one or more comma separated values. For the opaque data type, the value in this field represents constraints on the length of the Resource expressed in octets. For example, 1..42 indicates that the Resource can be 1 to 42 octets long. A value of 5,10,15 in this field indicates that the Resource can be 5, 10, or 15 octets long. A value of 8 in this field indicates that the Resource is always 8 octets long. For the string data type, a numeric range or enumeration has the same meaning as the opaque data type. Additionally, a comma separated list of quoted strings indicates the enumerated string values. For example, "foo","bar" indicates that the string Resource can only have the value foo or bar.
- **Units:** specifies the unit of the Resource value.
- **Description:** specifies the Resource description.

In addition to the object and resource templates described in the previous two tables of this section it is also important to document the syntax and semantic of the arguments of Executable Resources. The table below illustrates the method for documenting the arguments based on the plain text format following the ABNF format described in Section [Execute](#).

ID	Resource Name	Key	Name	Type	Range or Enum	Unit	Description
		[0:9]	String	Data Types	If any	If any	

Table: D.1-3 Executable Resource Arguments Definition

An example can be found with the Portfolio Object.

## D.2 Open Mobile Naming Authority (OMNA) Guidelines

This appendix defines guidelines for OMNA regarding registries and protocol ID ranges to be maintained.

### D.2.1 Object Registry

LwM2M Objects must be registered with the OMNA Lightweight Object registry. The rules for Object registry are documented at: <http://www.openmobilealliance.org/wp/OMNA/LwM2M/LwM2MRegistry.html>

Several LwM2M Object classes are defined with the matching Object ID ranges:

Class	URN segment	Object ID range	Description
OMA	oma	0-1023	Objects Produced by the Open Mobile Alliance.
reserved	N/A	1024-2047	Reserved for future use.
SDO	ext	2048-10240	Objects registered by third party standards organisations or alliances.
Vendors	x	10241-32768	Objects registered by vendors or individuals.
Company Reserved	x	32769-42768	Company bulk reservation of up to 50 Object IDs. This range is to create private LwM2M Objects that are not published on the OMNA Lightweight Object registry.
Test	x	42769-42800	Object IDs for testing purpose. These IDs MUST NOT be used in production as collisions with other Object IDs are possible.
reserved	N/A	42801-65534	Reserved for future use.

Table: D.2.1-1 LwM2M Object Classes

The URN format for an Object is automatically built from the class of Object, the Object ID and potentially the Object Version (see Section 6.2 Object Versioning) as follows:

urn:oma:lwm2m:{oma,ext,x}:{Object ID}[:{version}]

### D.2.2 Resource Registry

LwM2M Objects are specified as being composed of Resources, each identified by a Resource ID. Resources can either be specific to each Object with meaning only when used in that Object, or Reusable Resources can be registered, assigned an ID from the OMNA range and re-used in any Object.

The rules for registering Resource are documented at:

<http://www.openmobilealliance.org/wp/OMNA/LwM2M/LwM2MRegistry.html>

## Appendix E. LwM2M Objects defined by OMA (Normative)

This appendix provides LwM2M Objects defined by OMA SpecWorks that are a core part of the LwM2M specification. Other organizations and companies may define additional LwM2M Objects according to the guidelines provided in [Appendix D. LwM2M Object Template and Guidelines \(Normative\)](#).

The following LwM2M Object descriptions are contained in this appendix of the LwM2M v1.1 specification. Other objects can also be used with this version of LwM2M v1.1 and can be found in the OMNA registry.

Note: The objects found in this appendix are the versions that existed at the time of the enabler release. Please be aware that these objects evolve independently of the enabler release and the latest object versions are found in the LwM2M Registry.

Object Version	Object ID
LWM2M Security v1.2	0
LwM2M Server v1.2	1
LwM2M Access Control v1.1	2
Device v1.2	3
Connectivity Monitoring v1.3	4
Firmware Update v1.1	5
Location v1.0	6
Connectivity Statistics v1.0	7
LWM2M OSCORE v2.0	21
LwM2M COSE v1.0	23
MQTT Server v1.0	24
LwM2M Gateway v1.0	25
LwM2M Gateway Routing v1.0	26
5GNR Connectivity v1.0	27

Table: E.-1 LwM2M Objects

The LwM2M Server MUST support the Security, Server, and Device Objects. The LwM2M Server SHOULD support the Access Control, Connectivity, Firmware Update, Location, and Connectivity Statistics Objects.

### E.1 LwM2M Object: LwM2M Security

The LwM2M Client SHALL support the mandatory features in Object 0 as follows:

- When the Security Mode resource 2 = 3 (NoSec) resource 3 SHALL be set to null.
- When the Security Mode resource 2 = 3 (NoSec) or 0 (Pre-Shared Key) resource 4 SHALL be set to null.
- When the Security Mode resource 2 = 3 (NoSec) resource 5 SHALL be set to null.
- When the Security Mode resource 2 = 4 (Certificate mode with EST) resources 3 and 5 SHALL be set to null.

#### Description

This LwM2M Object provides the keying material of a LwM2M Client appropriate to access a specified LwM2M Server. One Object Instance SHOULD address a LwM2M Bootstrap-Server. These LwM2M Object Resources MUST only be changed by a LwM2M Bootstrap-Server or Bootstrap from Smartcard and MUST NOT be accessible by any other LwM2M Server.

## Object definition

Name	Object ID	Object Version	LWM2M Version
LWM2M Security	0	1.2	1.1
Object URN		Instances	Mandatory
urn:oma:lwm2m:oma:0:1.2		Multiple	Mandatory

Table: E.1-1 LwM2M Object: LWM2M Security object definition

## Resource definitions

ID	Name	Operations	Instances	Mandatory	Type	Range or Enumeration	Units	Description
0	LWM2M Server URI		Single	Mandatory	String	0..255		Uniquely identifies the LwM2M Server or LwM2M Bootstrap-Server. The format of the CoAP URI is defined in Section 6 of RFC 7252.
1	Bootstrap-Server		Single	Mandatory	Boolean			Determines if the current instance concerns a LwM2M Bootstrap-Server (true) or a standard LwM2M Server (false)
2	Security Mode		Single	Mandatory	Integer	0..4		Determines which security mode is used 0: Pre-Shared Key mode 1: Raw Public Key mode 2: Certificate mode 3: NoSec mode 4: Certificate mode with EST
3	Public Key or Identity		Single	Mandatory	Opaque			Stores the LwM2M Client's certificate, public key (RPK mode) or PSK Identity (PSK mode).
4	Server Public Key		Single	Mandatory	Opaque			Stores the LwM2M Server's, respectively LwM2M Bootstrap-Server's, certificate, public key (RPK mode) or trust anchor. The Certificate Mode Resource determines the content of this resource.
5	Secret Key		Single	Mandatory	Opaque			Stores the secret key (PSK mode) or private key (RPK or certificate mode).
6	SMS Security Mode		Single	Optional	Integer	0..255		Determines which SMS security mode is used: 0: Reserved for future use 1: DTLS mode (Device terminated) PSK mode assumed 2: Secure Packet Structure mode (Smartcard terminated) 3: NoSec mode 4: Reserved mode (DTLS mode with multiplexing Security Association support) 5-203 : Reserved for future use 204-255: Proprietary modes
7	SMS Binding Key Parameters		Single	Optional	Opaque	6		Stores the KIC, KID, SPI and TAR.
8	SMS Binding Secret Key(s)		Single	Optional	Opaque	16,32,48		Stores the values of the key(s) for the SMS binding.
9	LwM2M Server SMS Number		Single	Optional	String			MSISDN used by the LwM2M Client to send messages to the LwM2M Server via the SMS binding.

10	Short Server ID		Single	Optional	Integer	1..65534		This identifier uniquely identifies each LwM2M Server configured for the LwM2M Client. This Resource MUST be set when the Bootstrap-Server Resource has a value of 'false'. The values ID:0 and ID:65535 values MUST NOT be used for identifying the LwM2M Server.
11	Client Hold Off Time		Single	Optional	Integer		s	The number of seconds to wait before initiating a Client Initiated Bootstrap once the LwM2M Client has determined it should initiate this bootstrap mode. In case client initiated bootstrap is supported by the LwM2M Client, this resource MUST be supported. This information is relevant for use with a Bootstrap-Server only.
12	Bootstrap-Server Account Timeout		Single	Optional	Integer		s	The LwM2M Client MUST purge the LwM2M Bootstrap-Server Account after the timeout value given by this resource. The lowest timeout value is 1. If the value is set to 0, or if this resource is not instantiated, the Bootstrap-Server Account lifetime is infinite.
13	Matching Type		Single	Optional	Unsigned Integer	0..3		The Matching Type Resource specifies how the certificate or raw public key in in the Server Public Key is presented. Four values are currently defined: 0: Exact match. This is the default value and also corresponds to the functionality of LwM2M v1.0. Hence, if this resource is not present then the content of the Server Public Key Resource corresponds to this value. 1: SHA-256 hash [RFC6234] 2: SHA-384 hash [RFC6234] 3: SHA-512 hash [RFC6234]
14	SNI		Single	Optional	String			This resource holds the value of the Server Name Indication (SNI) value to be used during the TLS handshake. When this resource is present then the LwM2M Server URI acts as the address of the service while the SNI value is used for matching a presented certificate, or PSK identity.
15	Certificate Usage		Single	Optional	Unsigned Integer	0..3		The Certificate Usage Resource specifies the semantic of the certificate or raw public key stored in the Server Public Key Resource, which is used to match the certificate presented in the TLS/DTLS handshake. The currently defined values are 0 for "CA constraint", 1 for "service certificate constraint", 2 for "trust anchor assertion", and 3 for "domain-issued certificate". When this resource is absent, value (3) for domain issued certificate mode is assumed. More details about the semantic of each value can be found in the security consideration section of the LwM2M specification.
16	DTLS/TLS Ciphersuite		Multiple	Optional	Unsigned Integer			When this resource is present it instructs the TLS/DTLS client to propose the indicated ciphersuite(s) in the ClientHello of the handshake. A ciphersuite is indicated as a 32-bit integer value. The IANA TLS ciphersuite registry is maintained at <a href="https://www.iana.org/assignments/tls-parameters/tls-parameters.xhtml">https://www.iana.org/assignments/tls-parameters/tls-parameters.xhtml</a> . As an example, the TLS_PSK_WITH_AES_128_CCM_8 ciphersuite is represented with the following string "0xCo,0xA8". To form an integer value the two values are concatenated. In this example, the value is 0xcoa8 or 49320.
17	OSCORE Security Mode		Single	Optional	ObjInk			If this resource is defined, it provides a link to the OSCORE Object Instance and OSCORE MUST be used by the LwM2M Client with the linked OSCORE Object Instance.

18	Groups To Use by Client		Multiple	Optional	Unsigned Integer	0..65535		If this resource is defined, it indicates what groups the LwM2M Client should use with a LwM2M Server/LwM2M Bootstrap-Server (ordered from most preferred to least preferred). Resource instance 0 indicates the most preferred group. The values are taken from Section 4.2.7 of RFC 8446. An example is secp256r1 (0x0017).
19	Signature Algorithms Supported by Server		Multiple	Optional	Unsigned Integer	0..65535		If this resource is defined, it indicates what signature algorithms the LwM2M Server/LwM2M Bootstrap-Server supports. The values are taken from Section 4.2.3 of RFC 8446. An example is ecdsa_secp256r1_sha256(0x0403).
20	Signature Algorithms To Use by Client		Multiple	Optional	Unsigned Integer	0..65535		If this resource is defined, it indicates what signature algorithms the LwM2M Client should use with a LwM2M Server/LwM2M Bootstrap-Server (ordered from most preferred to least preferred). Resource instance 0 indicates the most preferred group. The values are taken from Section 4.2.3 of RFC 8446. An example is ecdsa_secp256r1_sha256(0x0403).
21	Signature Algorithm Certs Supported by Server		Multiple	Optional	Unsigned Integer	0..65535		If this resource is defined, it indicates what certificate-specific signature algorithms the LwM2M Server/LwM2M Bootstrap-Server supports. The values are taken from Section 4.2.3 of RFC 8446. An example is ecdsa_secp256r1_sha256(0x0403).
22	TLS 1.3 Features To Use by Client		Single	Optional	Unsigned Integer	0..65535		If this resource is defined, it indicates which features the LwM2M Client should use with the respective LwM2M Server/LwM2M Bootstrap-Server. The bitmask values listed below are defined. A bit value of '0' means the feature should not be used. bit(0) - PSK Plain, bit(1) - 0-RTT, bit(2) - PSK with PFS, bit(3) - Certificate-based Authentication. Bit(4) to bit(31) are reserved.
23	TLS Extensions Supported by Server		Single	Optional	Unsigned Integer	0..65535		If this resource is defined, it indicates what extensions the LwM2M Server/LwM2M Bootstrap-Server supports in form of a bitmap. The following values are defined: bit(0) - Server Name Indication (RFC 6066), bit (1) - Max Fragment Length (RFC 6066), bit (2) - Status Request (RFC 6066), bit (3) - Heartbeat (RFC 6520), bit (4) - Application Layer Protocol Negotiation (RFC 7301), bit (5) - Signed Certificate Timestamp (RFC 6962), bit (6) - Certificate Compression (draft-ietf-tls-certificate-compression), bit (7) - Record Size Limit (RFC 8449), bit (8) - Ticket Pinning (draft-ietf-tls-pinning-ticket), bit (9) - Certificate Authorities (RFC 8446), bit (10) - OID Filters (RFC 8446), bit (11) - Post Handshake Auth (RFC 8446), bit (12) - Connection ID (draft-ietf-tls-dtls-connection-id/draft-ietf-tls-dtls13). Bit(13) to bit(31) are reserved.

24	TLS Extensions To Use by Client		Single	Optional	Unsigned Integer	0..65535		If this resource is defined, it indicates what extensions the LwM2M Client should use with the LwM2M Server/LwM2M Bootstrap-Server in form of a bitmap. The following values are defined: bit(0) - Server Name Indication (RFC 6066), bit (1) - Max Fragment Length (RFC 6066), bit (2) - Status Request (RFC 6066), bit (3) - Heartbeat (RFC 6520), bit (4) - Application Layer Protocol Negotiation (RFC 7301), bit (5) - Signed Certificate Timestamp (RFC 6962), bit (6) - Certificate Compression (draft-ietf-tls-certificate-compression), bit (7) - Record Size Limit (RFC 8449), bit (8) - Ticket Pinning (draft-ietf-tls-pinning-ticket), bit (9) - Certificate Authorities (RFC 8446), bit (10) - OID Filters (RFC 8446), bit (11) - Post Handshake Auth (RFC 8446), bit (12) - Connection ID (draft-ietf-tls-dtls-connection-id/draft-ietf-tls-dtls13). Bit(13) to bit(31) are reserved.
25	Secondary LwM2M Server URI		Multiple	Optional	String	0..255		If this resource is present then the LwM2M Server URI in the Security Object, Resource ID 0, is augmented with information about further LwM2M Server URIs that can be used with the same security information found in the LwM2M Security Object. This is useful when a LwM2M Server is reachable via two different transport bindings (i.e. URIs). For example when the same server is reachable with two different URIs, such as a "coaps" and a "coaps+tcp" URI scheme.
26	MQTT Server		Single	Optional	ObjInk			If this resource is defined, it provides a link to a MQTT Server Object Instance, which offers additional configuration information for use with this MQTT server. This Resource is used only when the URI scheme in the LwM2M Server URI Resource indicates the use of MQTT.
27	LwM2M COSE Security		Multiple	Optional	ObjInk			If this resource is defined, it provides a links to LwM2M COSE Object Instances, which contain security-relevant configuration information for use with COSE.
28	RDS Destination Port		Single	Optional	Integer	0..15		This resource provides the default RDS Destination Port Number (as defined in 3GPP TS 24.250) to use for contacting the LwM2M or Bootstrap Server when communicating through the SCEF across the Non-IP binding.
29	RDS Source Port		Single	Optional	Integer	0..15		This resource provides the default RDS Source Port Number (as defined in 3GPP TS 24.250) to use for contacting the LwM2M or Bootstrap Server when communicating through the SCEF across the Non-IP binding.
30	RDS Application ID		Single	Optional	String			This resource provides the Application ID (as defined in 3GPP TS 24.250) to use for querying the SCEF for the source and destination port numbers for contacting the LwM2M or Bootstrap Server when communicating through the SCEF across the Non-IP binding.

Table: E.1-2 LwM2M Object: LWM2M Security Resource definitions

## E.2 LwM2M Object: LwM2M Server

### Description

This LwM2M Objects provides the data related to a LwM2M Server. A Bootstrap-Server has no such an Object Instance

associated to it.

### Object definition

Name	Object ID	Object Version	LWM2M Version
Lwm2m Server	1	1.2	1.2
Object URN		Instances	Mandatory
urn:oma:lwm2m:oma:1:1.2		Multiple	Mandatory

Table: E. 2-1 Lwm2m Object: Lwm2m Server object definition

### Resource definitions

ID	Name	Operations	Instances	Mandatory	Type	Range or Enumeration	Units	Description
0	Short Server ID	R	Single	Mandatory	Integer	1..65534		Used as link to associate server Object Instance.
1	Lifetime	RW	Single	Mandatory	Integer		s	Specify the lifetime of the registration in seconds (see Client Registration Interface). If the value is set to 0, the lifetime is infinite.
2	Default Minimum Period	RW	Single	Optional	Integer		s	The default value the Lwm2m Client should use for the Minimum Period of an Observation in the absence of this parameter being included in an Observation. If this Resource doesn't exist, the default value is 0.
3	Default Maximum Period	RW	Single	Optional	Integer		s	The default value the Lwm2m Client should use for the Maximum Period of an Observation in the absence of this parameter being included in an Observation.
4	Disable	E	Single	Optional				If this Resource is executed, this Lwm2m Server Object is disabled for a certain period defined in the Disabled Timeout Resource. After receiving "Execute" operation, Lwm2m Client MUST send response of the operation and perform de-registration process, and underlying network connection between the Client and Server MUST be disconnected to disable the Lwm2m Server account. After the above process, the Lwm2m Client MUST NOT send any message to the Server and ignore all the messages from the Lwm2m Server for the period.
5	Disable Timeout	RW	Single	Optional	Integer		s	A period to disable the Server. After this period, the Lwm2m Client MUST perform registration process to the Server. If this Resource is not set, a default timeout value is 86400 (1 day).

6	Notification Storing When Disabled or Offline	RW	Single	Mandatory	Boolean			If true, the LwM2M Client stores "Notify" operations to the LwM2M Server while the LwM2M Server account is disabled or the LwM2M Client is offline. After the LwM2M Server account is enabled or the LwM2M Client is online, the LwM2M Client reports the stored "Notify" operations to the Server. If false, the LwM2M Client discards all the "Notify" operations or temporarily disables the Observe function while the LwM2M Server is disabled or the LwM2M Client is offline. The default value is true. The maximum number of storing Notifications per Server is up to the implementation.
7	Binding	RW	Single	Mandatory	String			The possible values are those listed in the LwM2M Core Specification. This Resource defines the transport binding configured for the LwM2M Client. If the LwM2M Client supports the binding specified in this Resource, the LwM2M Client MUST use that transport for the Current Binding Mode.
8	Registration Update Trigger	E	Single	Mandatory				If this Resource is executed the LwM2M Client MUST perform an "Update" operation with this LwM2M Server. The LwM2M Client can use a transport binding supported in the Current Binding Mode, Preferred Transport resource or the transport specified as an argument in the Registration Update Trigger.
9	Bootstrap-Request Trigger	E	Single	Optional				When this Resource is executed the LwM2M Client MUST initiate a "Client Initiated Bootstrap" procedure in using the LwM2M Bootstrap-Server Account.
10	APN Link	RW	Single	Optional	Objlnk			If this resource is defined, it provides a link to the APN connection profile Object Instance (OMNA registered Object ID:11) to be used to communicate with this server.
11	TLS-DTLS Alert Code	R	Single	Optional	Unsigned Integer	0..255		If this resource is defined, it contains the most recent TLS / DTLS alert message received from the LwM2M Server respective represented by the AlertDescription defined in Section 7.2 of RFC 5246. This resource set by the LwM2M Client may help the LwM2M Bootstrap-Server to determine the cause of TLS/DTLS connection failure with the respective LwM2M Server.
12	Last Bootstrapped	R	Single	Optional	Time			If this resource is defined, it represents the last time that the bootstrap server updated this LwM2M Server Account. The LwM2M Client is responsible for updating this value. When the Bootstrap Server detects that this LwM2M Server Account is "out-of-date", the Bootstrap Server can update the LwM2M Server Account as represented by the LwM2M Server object instance.
13	Registration Priority Order	R	Single	Optional	Unsigned Integer			The LwM2M Client sequences the LwM2M Server registrations in increasing order of this value. If this value is not defined, registration attempts to this server are not impacted by other server registrations.

14	Initial Registration Delay Timer	RW	Single	Optional	Unsigned Integer		s	The delay, in seconds, before registration is attempted for this LwM2M Server based upon the completion of registration of the previous LwM2M Server in the registration order. This is only applied until the first successful registration after a successful bootstrapping sequence.
15	Registration Failure Block	R	Single	Optional	Boolean			When set to true and registration to this LwM2M server fails, the LwM2M Client blocks registration to other servers in the order. When set to false, the LwM2M Client proceeds with registration to the next server in the order.
16	Bootstrap on Registration Failure	R	Single	Optional	Boolean			If set to true, this indicates that the LwM2M Client should re-bootstrap when either registration is explicitly rejected by the LwM2M Server or registration is considered as failing as dictated by the other resource settings. If set to false, the LwM2M Client will continue with the registration attempts as dictated by the other resource settings.
17	Communication Retry Count	RW	Single	Optional	Unsigned Integer			The number of successive communication attempts before which a communication sequence is considered as failed.
18	Communication Retry Timer	RW	Single	Optional	Unsigned Integer		s	The delay, in seconds, between successive communication attempts in a communication sequence. This value is multiplied by two to the power of the communication retry attempt minus one ( $2^{*(\text{retry attempt}-1)}$ ) to create an exponential back-off.
19	Communication Sequence Delay Timer	RW	Single	Optional	Unsigned Integer		s	The delay, in seconds, between successive communication sequences. A communication sequence is defined as the exhaustion of the Communication Retry Count and Communication Retry Timer values. A communication sequence can be applied to server registrations or bootstrapping attempts. MAX_VALUE means do not perform another communication sequence.
20	Communication Sequence Retry Count	RW	Single	Optional	Unsigned Integer			The number of successive communication sequences before which a registration attempt is considered as failed.
21	Trigger	RW	Single	Optional	Boolean			Using the Trigger Resource a LwM2M Client can indicate whether it is reachable over SMS (value set to 'true') or not (value set to 'false'). The default value (resource not present) is 'false'. When set to 'true' the LwM2M Server MAY, for example, request the LwM2M Client to perform operations, such as the "Update" operation by sending an "Execute" operation on "Registration Update Trigger" Resource via SMS. No SMS response is expected for such a message.
22	Preferred Transport	RW	Single	Optional	String	The possible values are those listed in the LwM2M Core Specification		Only a single transport binding SHALL be present. When the LwM2M client supports multiple transports, it MAY use this transport to initiate a connection. This resource can also be used to switch between multiple transports e.g. a non-IP device can switch to UDP transport to perform firmware updates.
23	Mute Send	RW	Single	Optional	Boolean			If true or the Resource is not present, the LwM2M Client Send command capability is de-activated. If false, the LwM2M Client Send Command capability is activated.

24	Alternate APN Links	RW	Multiple	Optional	Objlnk			If this resource is defined, it provides links to alternate APN connection profile Object Instance (OMNA registered Object ID:11) to be used to communicate with this server if Resource 10 has configuration conflicts.
25	Supported Server Versions	RW	Multiple	Optional	String			This resource provides the supported enabler versions of the server to the client as a set of strings. Format for each string is 1*DIGIT". "1*DIGIT". "1*DIGIT where the third DIGIT is optional.
26	Default Notification Mode	RW	Single	Optional	Integer	0..1		This resource indicates the default mode for observations to be sent: 0 = Non-Confirmable, 1 = Confirmable.
27	Profile ID Hash Algorithm	RW	Single	Optional	Unsigned Integer	0..255		If this resource is defined, it contains the hash algorithm the LwM2M Server would prefer the LwM2M Client to use with the dynamically generated mode of creating Profile IDs. The numerical ID value of the 'Suite Identifiers' registered by RFC 6920 is used in this Resource.

Table: E.2-2 LwM2M Object: LwM2M Server Resource definitions

### E.3 LwM2M Object: LwM2M Access Control

#### Description

Access Control Object is used to check whether the LwM2M Server has access right for performing an operation.

#### Object definition

Name	Object ID	Object Version	LWM2M Version
LwM2M Access Control	2	1.1	1.0
Object URN		Instances	Mandatory
urn:oma:lwm2m:oma:2:1.1		Multiple	Optional

Table: E.3-1 LwM2M Object: LwM2M Access Control object definition

#### Resource definitions

ID	Name	Operations	Instances	Mandatory	Type	Range or Enumeration	Units	Description
0	Object ID	R	Single	Mandatory	Integer	1..65534		Resources 0 and 1 point to the Object Instance for which the Instances of the ACL Resource of that Access Control Object Instance are applicable.
1	Object Instance ID	R	Single	Mandatory	Integer	0..65535		See above

2	ACL	RW	Multiple	Optional	Integer	0..31		The Resource Instance ID MUST be the Short Server ID of a certain LwM2M Server for which associated access rights are contained in the Resource Instance value. The Resource Instance ID 0 is a specific ID, determining the ACL Instance which contains the default access rights. Each bit set in the Resource Instance value, grants an access right to the LwM2M Server to the corresponding operation. The bit order is specified as below. 1st LSB: R(Read, Observe, Write-Attributes) 2nd LSB: W(Write) 3rd LSB: E(Execute) 4th LSB: D(Delete) 5th LSB: C(Create) Other bits are reserved for future use.
3	Access Control Owner	RW	Single	Mandatory	Integer	0..65535		Short Server ID of a certain LwM2M Server; only such an LwM2M Server can manage the Resources of this Object Instance. The specific value MAX_ID=65535 means this Access Control Object Instance is created and modified during a Bootstrap phase only.

Table: E.3-2 LwM2M Object: LwM2M Access Control Resource definitions

## E.4 LwM2M Object: Device

### Description

This LwM2M Object provides a range of device related information which can be queried by the LwM2M Server, and a device reboot and factory reset function.

### Object definition

Name	Object ID	Object Version	LWM2M Version
Device	3	1.2	1.1
Object URN		Instances	Mandatory
urn:oma:lwm2m:oma:3:1.2		Single	Mandatory

Table: E.4-1 LwM2M Object: Device object definition

### Resource definitions

ID	Name	Operations	Instances	Mandatory	Type	Range or Enumeration	Units	Description
0	Manufacturer	R	Single	Optional	String			Human readable manufacturer name
1	Model Number	R	Single	Optional	String			A model identifier (manufacturer specified string)
2	Serial Number	R	Single	Optional	String			Serial Number
3	Firmware Version	R	Single	Optional	String			Current firmware version of the Device. The Firmware Management function could rely on this resource.
4	Reboot	E	Single	Mandatory				Reboot the LwM2M Device to restore the Device from unexpected firmware failure.

5	Factory Reset	E	Single	Optional				Perform factory reset of the LwM2M Device to make the LwM2M Device to go through initial deployment sequence where provisioning and bootstrap sequence is performed. This requires client ensuring post factory reset to have minimal information to allow it to carry out one of the bootstrap methods specified in section 5.2.3. When this Resource is executed, "De-register" operation MAY be sent to the LwM2M Server(s) before factory reset of the LwM2M Device.
6	Available Power Sources	R	Multiple	Optional	Integer	0..7		0: DC power 1: Internal Battery 2: External Battery 3: Fuel Cell 4: Power over Ethernet 5: USB 6: AC (Mains) power 7: Solar The same Resource Instance ID MUST be used to associate a given Power Source (Resource ID:6) with its Present Voltage (Resource ID:7) and its Present Current (Resource ID:8)
7	Power Source Voltage	R	Multiple	Optional	Integer			Present voltage for each Available Power Sources Resource Instance. The unit used for this resource is in mV.
8	Power Source Current	R	Multiple	Optional	Integer			Present current for each Available Power Source. The unit used for this resource is in mA.
9	Battery Level	R	Single	Optional	Integer	0..100	/100	Contains the current battery level as a percentage (with a range from 0 to 100). This value is only valid for the Device internal Battery if present (one Available Power Sources Resource Instance is 1).
10	Memory Free	R	Single	Optional	Integer			Estimated current available amount of storage space which can store data and software in the LwM2M Device (expressed in kilobytes). Note: 1 kilobyte corresponds to 1000 bytes.
11	Error Code	R	Multiple	Mandatory	Integer	0..32		0=No error 1=Low battery power 2=External power supply off 3=GPS module failure 4=Low received signal strength 5=Out of memory 6=SMS failure 7=IP connectivity failure 8=Peripheral malfunction 9..15=Reserved for future use 16..32=Device specific error codes When the single Device Object Instance is initiated, there is only one error code Resource Instance whose value is equal to 0 that means no error. When the first error happens, the LwM2M Client changes error code Resource Instance to any non-zero value to indicate the error type. When any other error happens, a new error code Resource Instance is created. When an error associated with a Resource Instance is no longer present, that Resource Instance is deleted. When the single existing error is no longer present, the LwM2M Client returns to the original no error state where Instance 0 has value 0. This error code Resource MAY be observed by the LwM2M Server. How to deal with LwM2M Client's error report depends on the policy of the LwM2M Server. Error codes in between 16 and 32 are specific to the Device and may have different meanings among implementations.
12	Reset Error Code	E	Single	Optional				Delete all error code Resource Instances and create only one zero-value error code that implies no error, then re-evaluate all error conditions and update and create Resources Instances to capture all current error conditions.

13	Current Time	RW	Single	Optional	Time			Current UNIX time of the LwM2M Client. The LwM2M Client should be responsible to increase this time value as every second elapses. The LwM2M Server is able to write this Resource to make the LwM2M Client synchronized with the LwM2M Server.
14	UTC Offset	RW	Single	Optional	String			Indicates the UTC offset currently in effect for this LwM2M Device. UTC+X [ISO 8601].
15	Timezone	RW	Single	Optional	String			Indicates in which time zone the LwM2M Device is located, in IANA Timezone (TZ) database format.
16	Supported Binding and Modes	R	Single	Mandatory	String			Indicates which bindings and modes are supported in the LwM2M Client. The possible values are those listed in the LwM2M Core Specification.
17	Device Type	R	Single	Optional	String			Type of the device (manufacturer specified string: e.g. smart meters / dev Class / ...)
18	Hardware Version	R	Single	Optional	String			Current hardware version of the device
19	Software Version	R	Single	Optional	String			Current software version of the device (manufacturer specified string). On elaborated LwM2M device, SW could be split in 2 parts: a firmware one and a higher level software on top. Both pieces of Software are together managed by LwM2M Firmware Update Object (Object ID 5)
20	Battery Status	R	Single	Optional	Integer	0..6		This value is only valid for the Device Internal Battery if present (one Available Power Sources Resource Instance value is 1). Battery Status Meaning Description 0 Normal The battery is operating normally and not on power. 1 Charging The battery is currently charging. 2 Charge Complete The battery is fully charged and still on power. 3 Damaged The battery has some problem. 4 Low Battery The battery is low on charge. 5 Not Installed The battery is not installed. 6 Unknown The battery information is not available.
21	Memory Total	R	Single	Optional	Integer			Total amount of storage space which can store data and software in the LwM2M Device (expressed in kilobytes). Note: 1 kilobyte corresponds to 1000 bytes.
22	ExtDevInfo	R	Multiple	Optional	Objlnk			Reference to external "Device" object instance containing information. For example, such an external device can be a Host Device, which is a device into which the Device containing the LwM2M client is embedded. This Resource may be used to retrieve information about the Host Device.

Table: E.4-2 LwM2M Object: Device Resource definitions

Battery Status	Meaning	Description
0	Normal	The battery is operating normally and not on power.
1	Charging	The battery is currently charging.
2	Charge Complete	The battery is fully charged and still on power.
3	Damaged	The battery has some problem.
4	Low Battery	The battery is low on charge.
5	Not Installed	The battery is not installed.

6	Unknown	The battery information is not available.
---	---------	---

Table: E.4-3 Battery Status

## E.5 LwM2M Object: Connectivity Monitoring

### Description

This LwM2M Object enables monitoring of parameters related to network connectivity. In this general connectivity Object, the Resources are limited to the most general cases common to most network bearers. It is recommended to read the description, which refers to relevant standard development organizations (e.g. 3GPP, IEEE). The goal of the Connectivity Monitoring Object is to carry information reflecting the more up to date values of the current connection for monitoring purposes. Resources such as Link Quality, Radio Signal Strength, Cell ID are retrieved during connected mode at least for cellular networks.

### Object definition

Name	Object ID	Object Version	LWM2M Version
Connectivity Monitoring	4	1.3	1.1
Object URN		Instances	Mandatory
urn:oma:lwm2m:oma:4:1.3		Single	Optional

Table: E.5-1 LwM2M Object: Connectivity Monitoring object definition

### Resource definitions

ID	Name	Operations	Instances	Mandatory	Type	Range or Enumeration	Units	Description
0	Network Bearer	R	Single	Mandatory	Integer	0..50		Indicates the network bearer used for the current LwM2M communication session from the network bearer list below. The number range is split into three categories: 0 - 20 are Cellular Bearers 21 - 40 are Wireless Bearers 41 - 50 are Wireline Bearers More specifically: 0: GSM cellular network 1: TD-SCDMA cellular network 2: WCDMA cellular network 3: CDMA2000 cellular network 4: WiMAX cellular network 5: LTE-TDD cellular network 6: LTE-FDD cellular network 7: NB-IoT 8: 5G-NR TDD 9: 5G-NR FDD 10 - 20: Reserved for other types of cellular network 21: WLAN network 22: Bluetooth network 23: IEEE 802.15.4 network 24 - 40: Reserved for other types of local wireless network 41: Ethernet 42: DSL 43: PLC 44 - 50: reserved for other types of wireline networks.
1	Available Network Bearer	R	Multiple	Mandatory	Integer	0..50		Indicates a list of current available network bearer. Each Resource Instance has a value from the network bearer list.

2	Radio Signal Strength	R	Single	Mandatory	Integer			dBm	Indicates the average value of the received signal strength indication used in the current network bearer (as indicated by Resource 0 of this Object). The value is expressed in dBm. For the following network bearers the signal strength parameters indicated below are represented by this resource: GSM: RSSI UMTS: RSCP LTE: RSRP NB-IoT: NRSRP For more details on Network Measurement Report, refer to the appropriate Cellular or Wireless Network standards, (e.g. for LTE Cellular Network refer to 3GPP TS 36.133 specification).
3	Link Quality	R	Single	Optional	Integer				This contains received link quality e.g. LQI for IEEE 802.15.4 (range 0..255), RxQual Downlink for GSM (range 0..7, refer to [3GPP 44.018] for more details on Network Measurement Report encoding), RSRQ for LTE, (refer to [3GPP 36.214]), NRSRQ for NB-IoT (refer to [3GPP 36.214]).
4	IP Addresses	R	Multiple	Mandatory	String				The IP addresses assigned to the connectivity interface. (e.g. IPv4, IPv6, etc.)
5	Router IP Addresses	R	Multiple	Optional	String				The IP address of the next-hop IP router, on each of the interfaces specified in resource 4 (IP Addresses). Note: This IP Address doesn't indicate the Server IP address.
6	Link Utilization	R	Single	Optional	Integer	0..100		/100	The percentage indicating the average utilization of the link to the next-hop IP router.
7	APN	R	Multiple	Optional	String				Access Point Name in case Network Bearer Resource is a Cellular Network.
8	Cell ID	R	Single	Optional	Integer				Serving Cell ID in case Network Bearer Resource is a Cellular Network. As specified in TS [3GPP 23.003] and in [3GPP. 24.008]. Range (0..65535) in GSM/EDGE UTRAN Cell ID has a length of 28 bits. Cell Identity in WCDMA/TD-SCDMA. Range: (0..268435455). LTE Cell ID has a length of 28 bits. Parameter definitions in [3GPP 25.331].
9	SMNC	R	Single	Optional	Integer	0..999			Serving Mobile Network Code. This is applicable when the Network Bearer Resource value is referring to a cellular network. As specified in TS [3GPP 23.003].
10	SMCC	R	Single	Optional	Integer	0..999			Serving Mobile Country Code. This is applicable when the Network Bearer Resource value is referring to a cellular network. As specified in TS [3GPP 23.003].
11	SignalSNR	R	Single	Optional	Integer			dB	SINR: Signal to Interference plus Noise Ratio SINR is the ratio of the strength of the received signal to the strength of the received interference signal (noise and interference).
12	LAC	R	Single	Optional	Integer				Location Area Code in case Network Bearer Resource is a Cellular Network. As specified in TS [3GPP 23.003] and in [3GPP. 24.008]
13	Coverage Enhancement Level	R	Single	Optional	Integer	0..4			Indicates the Coverage Enhancement Level of the UE in the serving cell. The Coverage Enhancement levels are defined and specified in 3GPP TS 36.331 and 36.213. 0: No Coverage Enhancement in the serving cell 1: Coverage Enhancement level 0 2: Coverage Enhancement level 1 3: Coverage Enhancement level 2 4: Coverage Enhancement level 3

Table: E.5-2 LwM2M Object: Connectivity Monitoring Resource definitions

## E.6 LwM2M Object: Firmware Update

### Description

This LwM2M Object enables management of firmware which is to be updated. This Object includes installing a firmware package, updating firmware, and performing actions after updating firmware. The firmware update MAY require to reboot the device; it will depend on a number of factors, such as the operating system architecture and the extent of the updated software. The envisioned functionality is to allow a LwM2M Client to connect to any LwM2M Server to obtain a firmware image using the object and resource structure defined in this section experiencing communication security protection using TLS/DTLS. There are, however, other design decisions that need to be taken into account to allow a manufacturer of a device to securely install firmware on a device. Examples for such design decisions are how to manage the firmware update repository at the server side (which may include user interface considerations), the techniques to provide additional application layer security protection of the firmware image, how many versions of firmware images to store on the device, and how to execute the firmware update process considering the hardware specific details of a given IoT hardware product. These aspects are considered to be outside the scope of this version of the specification. A LwM2M Server may also instruct a LwM2M Client to fetch a firmware image from a dedicated server (instead of pushing firmware images to the LwM2M Client). The Package URI resource is contained in the Firmware object and can be used for this purpose. A LwM2M Client MUST support block-wise transfer [CoAP\_Blockwise] if it implements the Firmware Update object. A LwM2M Server MUST support block-wise transfer. Other protocols, such as HTTP/HTTPs, MAY also be used for downloading firmware updates (via the Package URI resource). For constrained devices it is, however, RECOMMENDED to use CoAP for firmware downloads to avoid the need for additional protocol implementations.

### Object definition

Name	Object ID	Object Version	LWM2M Version
Firmware Update	5	1.2	1.1
Object URN		Instances	Mandatory
urn:oma:lwm2m:oma:5:1.2		Single	Optional

Table: E.6-1 LwM2M Object: Firmware Update object definition

### Resource definitions

ID	Name	Operations	Instances	Mandatory	Type	Range or Enumeration	Units	Description
0	Package	W	Single	Mandatory	Opaque			Firmware package
1	Package URI	RW	Single	Mandatory	String	0..255		URI from where the device can download the firmware package by an alternative mechanism. As soon the device has received the Package URI it performs the download at the next practical opportunity. The URI format is defined in RFC 3986. For example, coaps://example.org/firmware is a syntactically valid URI. The URI scheme determines the protocol to be used. For CoAP this endpoint MAY be a LwM2M Server but does not necessarily need to be. A CoAP server implementing block-wise transfer is sufficient as a server hosting a firmware repository and the expectation is that this server merely serves as a separate file server making firmware images available to LwM2M Clients.
2	Update	E	Single	Mandatory				Updates firmware by using the firmware package stored in Package, or, by using the firmware downloaded from the Package URI. This Resource is only executable when the value of the State Resource is Downloaded.

3	State	R	Single	Mandatory	Integer	0..3	Indicates current state with respect to this firmware update. This value is set by the LwM2M Client. 0: Idle (before downloading or after successful updating) 1: Downloading (The data sequence is on the way) 2: Downloaded 3: Updating If writing the firmware package to Package Resource has completed, or, if the device has downloaded the firmware package from the Package URI the state changes to Downloaded. Writing an empty string to Package URI Resource or setting the Package Resource to NULL (''), resets the Firmware Update State Machine: the State Resource value is set to Idle and the Update Result Resource value is set to 0. The device should remove the downloaded firmware image when the state is reset to Idle. When in Downloaded state, and the executable Resource Update is triggered, the state changes to Updating if the update starts immediately. For devices that support a user interface and the deferred update functionality, the user may be allowed to defer the firmware update to a later time. In this case, the state stays in Downloaded state and the Update Result is set to 11. Once a user accepted the firmware update, the state changes to Updating. When the user deferred the update, the device will continue operations normally until the user approves the firmware update or an automatic update starts. It will not block any operation on the device. If the Update Resource failed, the state may return to either Downloaded or Idle depending on the underlying reason of update failure, e.g. Integrity Check Failure results in the client moving to the Idle state. If performing the Update or Cancel operation was successful, the state changes to Idle. The firmware update state machine is illustrated in the respective LwM2M specification.
5	Update Result	R	Single	Mandatory	Integer	0..11	Contains the result of downloading or updating the firmware 0: Initial value. Once the updating process is initiated (Download /Update), this Resource MUST be reset to Initial value. 1: Firmware updated successfully. 2: Not enough flash memory for the new firmware package. 3: Out of RAM during downloading process. 4: Connection lost during downloading process. 5: Integrity check failure for new downloaded package. 6: Unsupported package type. 7: Invalid URI. 8: Firmware update failed. 9: Unsupported protocol. A LwM2M client indicates the failure to retrieve the firmware image using the URI provided in the Package URI resource by writing the value 9 to the /5/0/5 (Update Result resource) when the URI contained a URI scheme unsupported by the client. Consequently, the LwM2M Client is unable to retrieve the firmware image using the URI provided by the LwM2M Server in the Package URI when it refers to an unsupported protocol. 10: Firmware update cancelled. A Cancel operation has been executed successfully. 11: Firmware update deferred.
6	PkgName	R	Single	Optional	String	0..255	Name of the Firmware Package
7	PkgVersion	R	Single	Optional	String	0..255	Version of the Firmware package

8	Firmware Update Protocol Support	R	Multiple	Optional	Integer	0..5		This resource indicates what protocols the LwM2M Client implements to retrieve firmware images. The LwM2M server uses this information to decide what URI to include in the Package URI. A LwM2M Server MUST NOT include a URI in the Package URI object that uses a protocol that is unsupported by the LwM2M client. For example, if a LwM2M client indicates that it supports CoAP and CoAPS then a LwM2M Server must not provide an HTTP URI in the Packet URI. The following values are defined by this version of the specification: 0: CoAP (as defined in RFC 7252) with the additional support for block-wise transfer. CoAP is the default setting. 1: CoAPS (as defined in RFC 7252) with the additional support for block-wise transfer 2: HTTP 1.1 (as defined in RFC 7230) 3: HTTPS 1.1 (as defined in RFC 7230) 4: CoAP over TCP (as defined in RFC 8323) 5: CoAP over TLS (as defined in RFC 8323) Additional values MAY be defined in the future. Any value not understood by the LwM2M Server MUST be ignored.
9	Firmware Update Delivery Method	R	Single	Mandatory	Integer	0..2		The LwM2M Client uses this resource to indicate its support for transferring firmware images to the client either via the Package Resource (=push) or via the Package URI Resource (=pull) mechanism. 0: Pull only 1: Push only 2: Both. In this case the LwM2M Server MAY choose the preferred mechanism for conveying the firmware image to the LwM2M Client.
10	Cancel	E	Single	Optional				Cancels firmware update. Cancel can be executed if the device has not initiated the Update process. If the device is in the process of installing the firmware or has already completed installation it MUST respond with Method Not Allowed error code. Upon successful Cancel operation, Update Result Resource is set to 10 and State is set to 0 by the device.
11	Severity	RW	Single	Optional	Integer	0..2		Severity of the firmware image. 0: Critical 1: Mandatory 2: Optional This information is useful when the device provides option for the deferred update. Default value is 1.
12	Last State Change Time	R	Single	Optional	Time			This resource stores the time when the State resource is changed. Device updates this resource before making any change to the State.
13	Maximum Defer Period	RW	Single	Optional	Unsigned Integer		s	The number of seconds a user can defer the software update. When this time period is over, the device will not prompt the user for update and install it automatically. If the value is 0, a deferred update is not allowed.
14	Automatic Upgrade at Download	RW	Single	Optional	Boolean			Determines if the Firmware Upgrade will proceed automatically when the firmware download has completed. Value true means that the server does not need to instruct the device to proceed with the firmware upgrade when the firmware download is complete. Value false means that the server will have to instruct the device to proceed with the firmware upgrade when the firmware download is complete. When this is set to false, the server will use the Update resource to trigger the upgrade.

Table: E.6-2 LwM2M Object: Firmware Update Resource definitions

## E.6.1 Firmware Update State Machine

[Figure: E.6.1-1 Firmware Update Mechanisms](#) shows a possible implementation of the firmware update mechanism, described as a UML 2.0 state diagram. The state diagram consists of states, drawn as rounded rectangles, and transitions, drawn as arrows connecting the states. The syntax of the transition is trigger [guard] / behaviour. A trigger is an event that may cause a transition, guard is a condition and behaviour is an activity that executes while the transition takes place. The states additionally contain a compartment that includes assertions and variable assignments. For example, the assertion in the IDLE state indicates the value of the “Update Result” resource (abbreviated as “Res”) must be between 0 and 11. The State resource is set to zero (0) when the program is in this IDLE state.

Any operation to the Firmware Update Object that would result in undefined behavior because that specific operation is not identified as a trigger in the state machine (e.g. Write to Package URI while in DOWNLOADING state) SHOULD be rejected.

Errors during the Firmware Update process MUST be reported only by the “Update Result” resource. For instance, when the LwM2M Server performs a Write operation on resource “Package URI”, the LwM2M Client returns a Success or Failure for the Write operation. Then if the URI is invalid, it changes its “Update Result” resource value to 7.

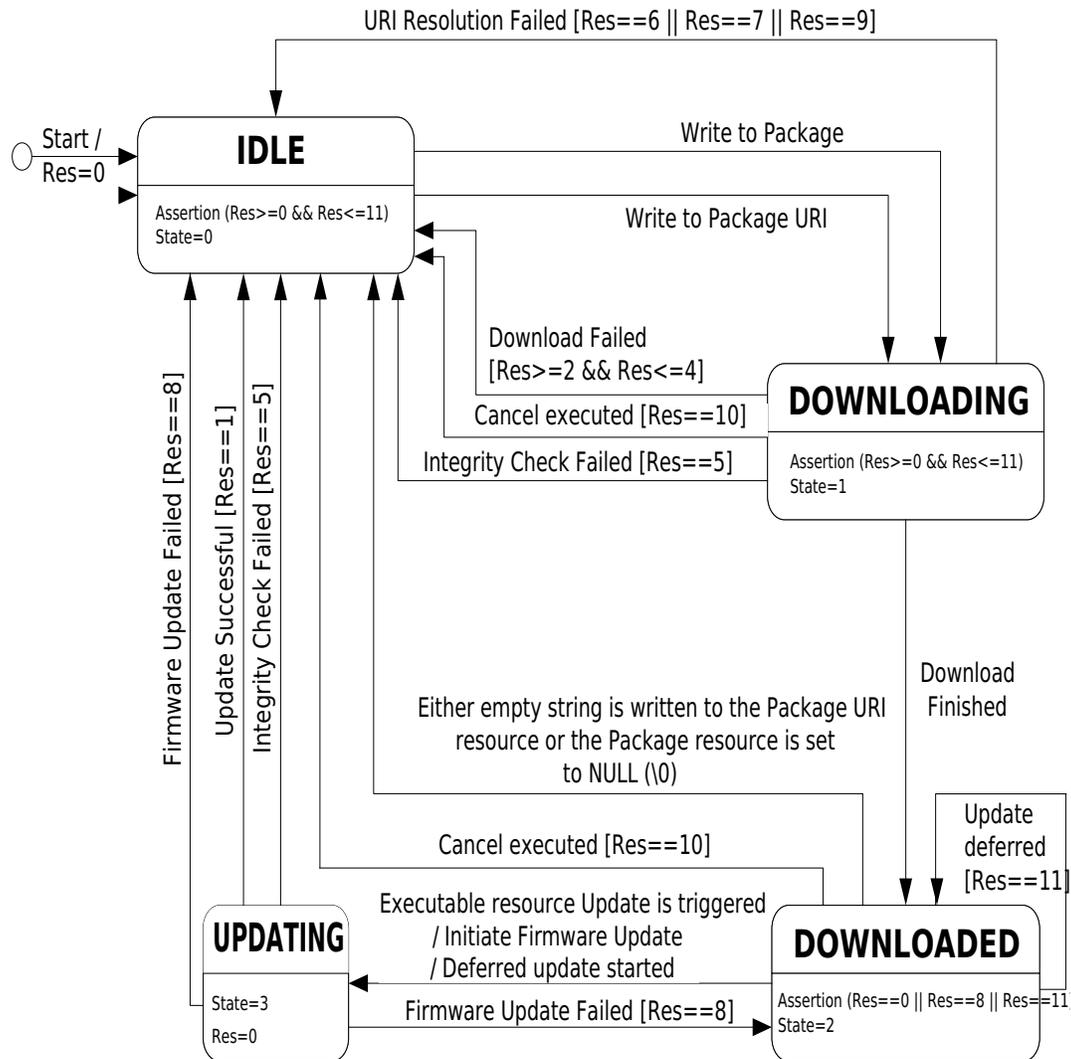

Figure: E.6.1-1 Firmware Update Mechanisms

## E.6.2 Examples

The example depicted in [Figure: E.6.2-1 Example of a LwM2M Server pushing a firmware image to a LwM2M client](#) illustrates a successful message exchange where a LwM2M Server pushes a firmware image to a LwM2M Client using the block-wise transfer. In this example the LwM2M Server indicates a block size of 128 bytes and the firmware image of 80 KiB (=81920 bytes) will be sent to the LwM2M Client in 640 messages with each 128 bytes payload. Since the LwM2M Server-provided block size matches the preferences of the LwM2M Client the exchange proceeds until the full firmware image is downloaded. In this example, no messages are lost during transmission.

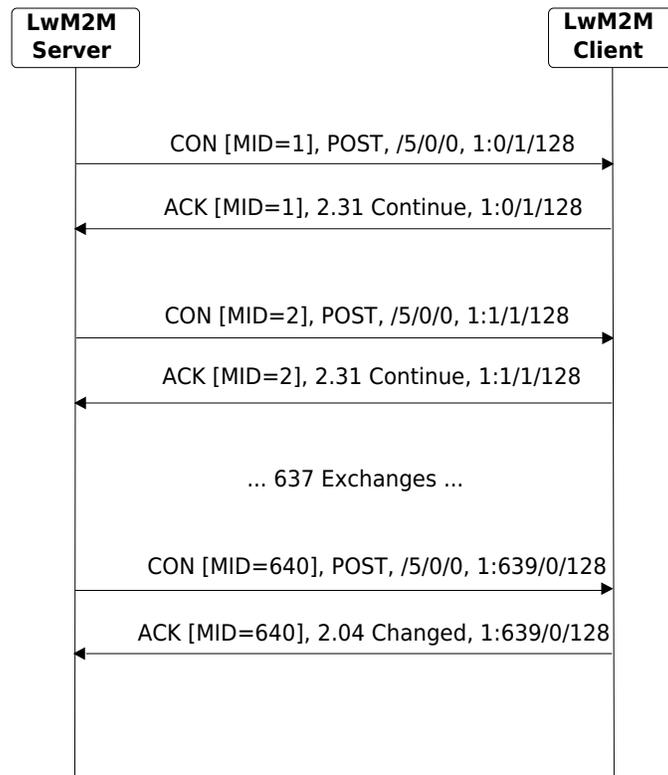

Figure: E.6.2-1 Example of a LwM2M Server pushing a firmware image to a LwM2M client

The second example shown in [Figure: E.6.2-2 Example of a client fetching a firmware image](#) illustrates the case where the client was provided with a URI by the LwM2M Server (using the Package URI resource) and therefore fetches the firmware image from the indicated server. Note that only the retrieval of the firmware image from the LwM2M Server is shown in [Figure: E.6.2-2 Example of a client fetching a firmware image](#) and not the initial configuration of the Package URI.

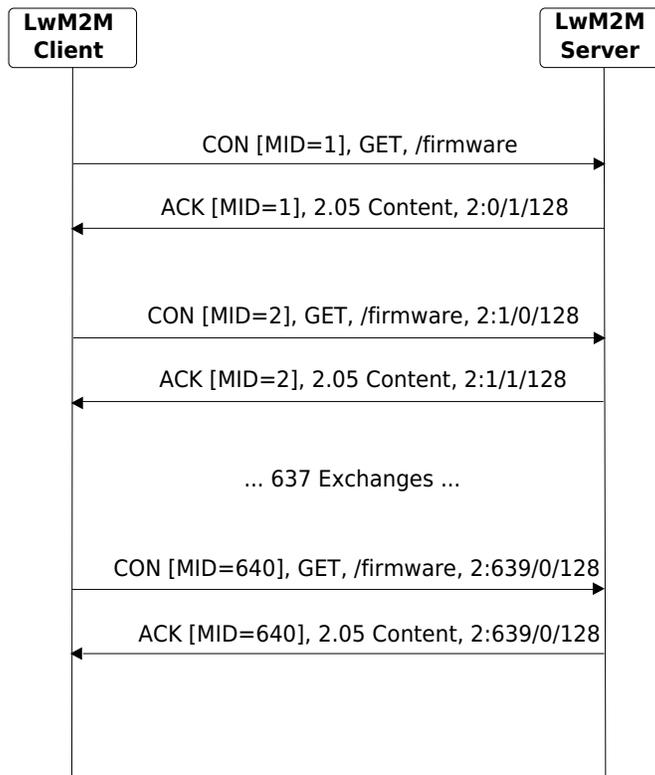

Figure: E.6.2-2 Example of a client fetching a firmware image

### E.6.3 Firmware Update Consideration

If some Objects are not supported after firmware update, the LwM2M Client MUST delete all Object Instances of the Objects that are not supported.

## E.7 LwM2M Object: Location

### Description

This LwM2M Object provides a range of location telemetry related information which can be queried by the LwM2M Server.

### Object definition

Name	Object ID	Object Version	LWM2M Version
Location	6	1.0	1.0
Object URN		Instances	Mandatory
urn:oma:lwm2m:oma:6		Single	Optional

Table: E.7-1 LwM2M Object: Location object definition

### Resource definitions

ID	Name	Operations	Instances	Mandatory	Type	Range or Enumeration	Units	Description
0	Latitude	R	Single	Mandatory	Float		lat	The decimal notation of latitude, e.g. -43.5723 [World Geodetic System 1984].
1	Longitude	R	Single	Mandatory	Float		lon	The decimal notation of longitude, e.g. 153.21760 [World Geodetic System 1984].
2	Altitude	R	Single	Optional	Float		m	The decimal notation of altitude in meters above sea level.
3	Radius	R	Single	Optional	Float		m	The value in this resource indicates the radius of a circular area in meters. The circular area is used to describe uncertainty about a point for coordinates in a two-dimensional coordinate reference systems (CRS). The center point of a circular area is specified by using the Latitude and the Longitude Resources.
4	Velocity	R	Single	Optional	Opaque			The velocity of the LwM2M Client, as defined in [3GPP-TS_23.032].
5	Timestamp	R	Single	Mandatory	Time			The timestamp of when the location measurement was performed.
6	Speed	R	Single	Optional	Float		m/s	Speed is the time rate of change in position of a LwM2M Client without regard for direction: the scalar component of velocity.

Table: E.7-2 LwM2M Object: Location Resource definitions

## E.8 LwM2M Object: Connectivity Statistics

### Description

This LwM2M Objects enables client to collect statistical information and enables the LwM2M Server to retrieve these information, set the collection duration and reset the statistical parameters.

### Object definition

Name	Object ID	Object Version	LWM2M Version
Connectivity Statistics	7	1.0	1.0
Object URN		Instances	Mandatory
urn:oma:lwm2m:oma:7		Single	Optional

Table: E.8-1 LwM2M Object: Connectivity Statistics object definition

### Resource definitions

ID	Name	Operations	Instances	Mandatory	Type	Range or Enumeration	Units	Description
0	SMS Tx Counter	R	Single	Optional	Integer			Indicate the total number of SMS successfully transmitted during the collection period.
1	SMS Rx Counter	R	Single	Optional	Integer			Indicate the total number of SMS successfully received during the collection period.
2	Tx Data	R	Single	Optional	Integer			Indicate the total amount of data (IP / non-IP) transmitted during the collection period expressed in kilobytes.

3	Rx Data	R	Single	Optional	Integer			Indicate the total amount of data (IP / non-IP) received during the collection period expressed in kilobytes.
4	Max Message Size	R	Single	Optional	Integer		B	The maximum IP message size that is used during the collection period.
5	Average Message Size	R	Single	Optional	Integer		B	The average IP message size that is used during the collection period.
6	Start	E	Single	Mandatory				Reset resources 0-5 to 0 and start to collect information, If resource 8 (Collection Period) value is 0, the client will keep collecting information until resource 7 (Stop) is executed, otherwise the client will stop collecting information after specified period ended. Note: When reporting the Tx Data or Rx Data, the LwM2M Client reports the total KB transmitted/received over IP bearer(s), including all protocol header bytes up to and including the IP header. This does not include lower level retransmissions/optimizations (e.g. RAN, header compression) or SMS messages.
7	Stop	E	Single	Mandatory				Stop collecting information, but do not reset resources 0-5.
8	Collection Period	RW	Single	Optional	Integer		s	The default collection period in seconds. The value 0 indicates that the collection period is not set.

Table: E.8-2 LwM2M Object: Connectivity Statistics Resource definitions

Note: When reporting the Tx Data or Rx Data, the LwM2M Client reports the total KB transmitted/received over IP bearer(s), including all protocol header bytes up to and including the IP header. This does not include lower level retransmissions/optimizations (e.g. RAN, header compression) or SMS messages.

## E.9 LwM2M Object: LWM2M OSCORE

### Description

This LwM2M Object provides the keying material and related information of a LwM2M Client appropriate to access a specified LwM2M Server using OSCORE. One Object Instance MAY address a LwM2M Bootstrap-Server. These LwM2M Object Resources MUST only be changed by a LwM2M Bootstrap-Server or Bootstrap from Smartcard and MUST NOT be accessible by any other LwM2M Server. Instances of this Object are linked from Instances of Object 0 using the OSCORE Security Mode Resource of Object 0. Instances of this Object MUST NOT be linked from more than one Instance of Object 0.

### Object definition

Name	Object ID	Object Version	LWM2M Version
LWM2M OSCORE	21	2.0	1.1
Object URN		Instances	Mandatory
urn:oma:lwm2m:oma:21:2.0		Multiple	Optional

Table: E.9-1 LwM2M Object: LWM2M OSCORE object definition

### Resource definitions

ID	Name	Operations	Instances	Mandatory	Type	Range or Enumeration	Units	Description
0	OSCORE Master Secret		Single	Mandatory	Opaque			This resource MUST be used to store the pre-shared key used in LwM2M Client and LwM2M Server/Bootstrap-Server, called the Master Secret.
1	OSCORE Sender ID		Single	Mandatory	Opaque			This resource MUST store an OSCORE identifier for the LwM2M Client called the Sender ID.
2	OSCORE Recipient ID		Single	Mandatory	Opaque			This resource MUST store an OSCORE identifier for the LwM2M Client called the Recipient ID.
3	OSCORE AEAD Algorithm		Single	Optional	Integer			This resource MUST be used to store the encoding of the AEAD Algorithm as defined in Table 10 of RFC 8152. The AEAD is used by OSCORE for encryption and integrity protection of CoAP message fields.
4	OSCORE HMAC Algorithm		Single	Optional	Integer			This resource MUST be used to store the encoding of the HMAC Algorithm used in the HKDF. The encoding of HMAC algorithms are defined in Table 7 of RFC 8152. The HKDF is used to derive the security context used by OSCORE.
5	OSCORE Master Salt		Single	Optional	Opaque			This resource MUST be used to store a non-secret random value called the Master Salt. The Master Salt is used to derive the security context used by OSCORE.
6	OSCORE ID Context		Single	Optional	Opaque			This resource MUST be used to store an OSCORE identifier called ID Context. This identifier is used to identify the Common Context and derive the security context used by OSCORE.

Table: E.9-2 LwM2M Object: LWM2M OSCORE Resource definitions

## E.10 LwM2M Object: LwM2M COSE

### Description

This Object provides the keying material and related information for use with COSE.

### Object definition

Name	Object ID	Object Version	LWM2M Version
LwM2M COSE	23	1.0	1.2
Object URN		Instances	Mandatory
urn:oma:lwm2m:oma:23		Multiple	Optional

Table: E.10-1 LwM2M Object: LwM2M COSE object definition

### Resource definitions

ID	Name	Operations	Instances	Mandatory	Type	Range or Enumeration	Units	Description
0	KID		Single	Mandatory	String			This resource is used to indicate the key identifier.
1	AEAD Algorithm		Single	Mandatory	Integer			This resource is used to store the encoding of the AEAD Algorithm as defined in Table 10 of RFC 8152.

2	Key		Single	Mandatory	String			This resource is used to store the key for use with the indicated AEAD algorithm.
---	-----	--	--------	-----------	--------	--	--	---

Table: E.10-2 LwM2M Object: LwM2M COSE Resource definitions

## E.11 LwM2M Object: MQTT Server

### Description

This object defines configuration parameters for an MQTT client to interact with a MQTT server.

### Object definition

Name	Object ID	Object Version	LWM2M Version
MQTT Server	24	1.0	1.2
Object URN		Instances	Mandatory
urn:oma:lwm2m:oma:24		Multiple	Optional

Table: E.11-1 LwM2M Object: MQTT Server object definition

### Resource definitions

ID	Name	Operations	Instances	Mandatory	Type	Range or Enumeration	Units	Description
0	Will Retain	RW	Single	Optional	Boolean			The Will Retain value to declare in the MQTT CONNECT message.
1	Will Topic	RW	Single	Optional	String			The Will Topic to include in the MQTT CONNECT message.
2	Will Message	RW	Single	Optional	String			The Will Message to include in the MQTT CONNECT message.
3	Clean Session	RW	Single	Optional	Boolean			The Clean Session value to declare in the MQTT CONNECT message.
4	Will QoS	RW	Single	Optional	Unsigned Integer	0..3		The Will QoS value to declare in the MQTT CONNECT message.
5	Keep Alive	RW	Single	Optional	Unsigned Integer	0..65535		The Keep Alive value to declare in the MQTT CONNECT message.
6	Client Identifier	RW	Single	Mandatory	String			The Client Identifier identifies the MQTT client to the MQTT server. It must support ClientIds which are between 1 and 23 UTF-8 encoded bytes in length, and that contain only the characters "0123456789abcdefghijklmnopqrstuvwxyzABCDEFGHIJKLMNOPQRSTUVWXYZ". MQTT server may allow ClientId's that contain more than 23 encoded bytes. Some MQTT servers may support ClientId's that contain characters not included in the list above.
7	User Name	RW	Single	Optional	String			The User Name to declare in the MQTT CONNECT message. It must be a non-empty string. It can be used by the MQTT server for authentication and authorization.
8	Password	RW	Single	Optional	Opaque			The Password value to declare in the MQTT CONNECT message.

Table: E.11-2 LwM2M Object: MQTT Server Resource definitions

## E.12 LwM2M Object: LwM2M Gateway

## Description

This object is used by a LwM2M Gateway to maintain the devices connected to the gateway.

## Object definition

Name	Object ID	Object Version	LWM2M Version
LwM2M Gateway	25	1.0	1.2
Object URN		Instances	Mandatory
urn:oma:lwm2m:oma:25		Multiple	Optional

Table: E.12-1 LwM2M Object: LwM2M Gateway object definition

## Resource definitions

ID	Name	Operations	Instances	Mandatory	Type	Range or Enumeration	Units	Description
0	Device ID	R	Single	Mandatory	String			This resource identifies the device connected to the gateway.
1	Prefix	RW	Single	Mandatory	String			This resource defines what prefix has to be used for access to objects of this device.
2	Routing Table Entry	R	Single	Optional	Objlnk			This resource links to the Object Instance in the LwM2M Routing Object.

Table: E.12-2 LwM2M Object: LwM2M Gateway Resource definitions

## E.13 LwM2M Object: LwM2M Gateway Routing

### Description

This object is used by a LwM2M Gateway to maintain the routing table.

### Object definition

Name	Object ID	Object Version	LWM2M Version
LwM2M Gateway Routing	26	1.0	1.2
Object URN		Instances	Mandatory
urn:oma:lwm2m:oma:26		Multiple	Optional

Table: E.13-1 LwM2M Object: LwM2M Gateway Routing object definition

## Resource definitions

ID	Name	Operations	Instances	Mandatory	Type	Range or Enumeration	Units	Description
0	LwM2M Object ID	R	Single	Mandatory	Unsigned Integer			This resource identifies mapping the LwM2M Object ID that is mapped with the Mapping Info Resource. It defines the source of the mapping.

1	Mapping Info	R	Single	Mandatory	CoreInk			This resource defines the target of the mapping. This Resource may be empty in which case the mapping is the identity function.
---	--------------	---	--------	-----------	---------	--	--	---

Table: E.13-2 LwM2M Object: LwM2M Gateway Routing Resource definitions

## E.14 LwM2M Object: 5G NR Connectivity

### Description

This is a device management object that should be used for 5G-NR capable devices.

### Object definition

Name	Object ID	Object Version	LWM2M Version
5G NR Connectivity	27	1.0	1.2
Object URN		Instances	Mandatory
urn:oma:lwm2m:oma:27		Multiple	Optional

Table: E.14-1 LwM2M Object: 5G NR Connectivity object definition

### Resource definitions

ID	Name	Operations	Instances	Mandatory	Type	Range or Enumeration	Units	Description
0	Connectivity Option	R	Single	Mandatory	Integer			Indicates the connectivity option. 1 = Core Network: EPC; Master RAT: LTE; Secondary RAT: - 3 = Core Network: EPC; Master RAT: LTE; Secondary RAT: NR 2 = Core Network: 5GC; Master RAT: NR; Secondary RAT: - 4 = Core Network: 5GC; Master RAT: NR; Secondary RAT: eLTE 5 = Core Network: 5GC; Master RAT: eLTE; Secondary RAT: - 7 = Core Network: 5GC; Master RAT: eLTE; Secondary RAT: NR
1	NR Band Support available	R	Multiple	Optional	Integer			Indicates the Operating NR Bands supported by UE in NSA mode. Value represents the integer value of band mentioned in 3GPP Spec 38.104 (Table: Table 5.2-1 and Table 5.2-2)
2	NR Band attached	R	Multiple	Optional	Integer			Indicates the Operating NR Bands on which UE is attached. Value represents the integer value of band mentioned in 3GPP Spec 38.104 (Table: Table 5.2-1 and Table 5.2-2)
3	S-NSSAI	R	Multiple	Optional	Integer			Indicates the Single - Network Slice Selection Assistance Information for 5G Standalone mode 0 = eMBB 1 = URLLC 2 = MIoT 3 = Custom 4-7 = Reserved
4	DNN Name	R	Single	Optional	String			Data Network Name in case of Network Bearer Resource is a 5G SA (FDD/TDD) Cellular Network.
5	PDU Session Id	R	Single	Optional	Integer	1...15		Indicates the PDU Session ID over which LwM2M session is established for 5G SA (FDD/TDD) Cellular Network.
6	SSC Mode	R	Single	Optional	Integer	1...3		Indicates the Session and Service Continuity mode for 5G SA (FDD/TDD) Cellular Network.

7	PDU Session Type	R	Single	Optional	Integer			Indicates the type of PDU session over which LwM2M connection is established for 5G SA (FDD/TDD) Cellular Network. 1 = IPv4 2 = IPv6 3 = IPv4v6 4 = Unstructured 5 = Ethernet 8 = Reserved (Spec Ref.)
8	5QI	R	Single	Optional	Integer			Indicates the 5G QoS Identifier for 5G SA (FDD/TDD) Cellular Network. 1-9,65,66,67,69,70,75,79,80,81,82,83,84,85 = Standard 128 to 254 = Operator specific 0,255 = Reserved Remaining = Spare (Spec Ref.)
9	SDAP Enablement	R	Single	Optional	Integer			Indicates whether SDAP is enabled or not for 5G SA (FDD/TDD) Cellular Network. 0 = in UL only 1 = In DL Only 2 = In UL and DL both
10	QFI	R	Single	Optional	Integer	1..63		Indicates the QoS Flow identifier for 5G SA (FDD/TDD) Cellular Network. (Spec Ref.)
11	Session AMBR	R	Single	Optional	Integer	1..25		Indicates the Session Aggregate Maximum Bit Rate as per the 5G 3GPP Spec for 5G SA (FDD/TDD) Cellular Network. (Spec Ref.)
12	APN-AMBR	R	Single	Optional	Integer		dB	The Aggregate Maximum Bitrate which is applicable to a given APN over which LwM2M session is established for 5G SA (FDD/TDD) Cellular Network.
13	NAS Reflective QoS	R	Single	Optional	Boolean			Indicates the QoS at NAS layer for 5G SA (FDD/TDD) Cellular Network. 0 = Disabled 1 = Enabled
14	Access Stratum Reflective QoS	R	Single	Optional	Boolean			Indicates the QoS for Access Stratum (RRC) for 5G SA (FDD/TDD) Cellular Network.. 0 = Absent 1 = Present
15	P-CSCF Address Index	R	Single	Optional	Integer			Index for the P-CSCF address for 5G SA (FDD/TDD) Cellular Network.
16	PDU session Authentication	R	Single	Optional	Integer			Indicates the Authentication type for PDU Session PDU session Authentication 0 = Primary 1 = Secondary 2 = Both
17	PLMN ID	R	Single	Optional	String			Indicates the PLMN ID over which UE is currently attached for 5G SA (FDD/TDD) Cellular Network. Allows server to see the current PLMN in string format (e.g. formatted as result of AT+COPS=? as per 3GPP-TS_27.007)
18	LADN Support	R	Single	Optional	Boolean			Indicates whether LADN (Local Area Data Network) is supported or not for 5G SA (FDD/TDD) Cellular Network. 0 = Not Supported 1 = Supported
19	Integrity Protection on DRB	R	Single	Optional	Integer			Current state of the Integrity Protection on Data Radio Bearer for 5G SA (FDD/TDD) Cellular Network. 0 = Disabled 1 = Enabled with 64-Kbps 2 = Enabled with Peak Rate
20	Access type Preference	R	Single	Optional	Boolean			Indicates the Access Type preference for 5G SA (FDD/TDD) Cellular Network. 0 = 3GPP 1 = Non-3GPP

Table: E.14-2 LwM2M Object: 5GNR Connectivity Resource definitions

## Appendix F. Example LwM2M Client (Informative)

This appendix defines an example LwM2M Client for a simple imaginary device with a cellular interface including instantiated Objects and their values, which are used throughout this specification in examples. The example client uses no Endpoint Client Name at the LwM2M messaging layer since the underlying security mechanisms already provide an authenticated identity.

The example device has two Server Objects (it is configured to register with two different LwM2M Servers), five accompanying Access Control Object Instances for those servers, a Device Object, a Connectivity Monitoring Object for a Cellular interface and a Firmware Update Object with no instance. The first Server controls the access control rights for both servers.

The Short Server ID 101 & 102, are respectively associated to the Server 1 and Server 2;

Object	Object ID	Object Instance ID
LwM2M Security Object[0]	0	0
LwM2M Security Object[1]	0	1
LwM2M Security Object[2]	0	2
LwM2M Server Object [1]	1	0
LwM2M Server Object [2]	1	1
Access Control Object [0]	2	0
Access Control Object [1]	2	1
Access Control Object [2]	2	2
Access Control Object [3]	2	3
Access Control Object [4]	2	4
Device Object	3	0
Connectivity Monitoring Object	4	0
Firmware Update Object	5	-

Table: F.-1 Object Instances of the example

Resource Name	Resource ID	Resource Instance ID	Value	Notes
LwM2M Server URI	0		coaps://bootstrap.example.com	Example LwM2M Bootstrap-Server
Bootstrap-Server	1		true	
Security Mode	2		0	PSK mode
Public Key or Identity	3		f81d4fae-7dec-11d0-a765-00a0c91e6bf6	Example of a PSK Identity string
Server Public Key	4			Unused in PSK mode
Secret Key	5		e129791359950cbb1c8c3c582913b551	128-bit random sequence in hex encoding for use as a PSK.
Client Hold Off Time	11		3600	

Table: F.-2 LwM2M Security Object [0]

Resource Name	Resource ID	Resource Instance ID	Value	Notes
LwM2M Server URI	0		coaps://server1.example.com	Example LwM2M Server 1
Bootstrap-Server	1		false	
Security Mode	2		0	PSK mode
Public Key or Identity	3		b313cc22-f969-42ec-ad42	Example of a PSK Identity string
Server Public Key	4			Unused in PSK mode
Secret Key	5		1ca2028d7197c778e9aef5ef69082bea	128-bit random sequence in hex encoding for use as a PSK.
Short Server ID	10		101	

Table: F.-3 LwM2M Security Object [1]

Resource Name	Resource ID	Resource Instance ID	Value	Notes
LwM2M Server URI	0		coaps://server2.example.com	Example LwM2M Server 2
Bootstrap-Server	1		false	
Security Mode	2	1		RPK mode
Public Key or Identity	3		3059301306072a8648ce3d020106082a8648ce3d03010703420004a09dcb1bc739e7f19afa9adcb1944968bfa73efcec29b50486eb44d1b29c193449970a3736830cb2bd5d7eco5d2bd1fco7b6df5e48b54ce77a6a7229c3a91c2	The raw public key of the LwM2M Client in ASN.1 DER format. The textual representation of the key can be found below labelled as *.
Server Public Key	4		3059301306072a8648ce3d020106082a8648ce3d0301070342000482c773f378d30c2783a48eb811b96cf6a90694a8564f1e7f6d366152f11698950f6f7c40cda585334f837750a102f5bf25508ceb9e55dfcof12a45199a4c960	The raw public key of the LwM2M Server in ASN.1 DER format. The textual representation of the key can be found below labelled as **.
Secret Key	5		307702010104209f352da16495748e146fcb5370b8e96d292ced5567a8fae55a22bb67d91651b8a00a06082a8648ce3d030107a14403420004a09dcb1bc739e7f19afa9adcb1944968bfa73efcec29b50486eb44d1b29c193449970a3736830cb2bd5d7eco5d2bd1fco7b6df5e48b54ce77a6a7229c3a91c2	The private key of the client in PKCS#8 format. The textual representation of the key can be found below labelled as ***.
Short Server ID	10		102	

Table: F.-4 LwM2M Security Object [2]

\*: The client public key in text representation:

```

0 89: SEQUENCE {
2 19: SEQUENCE {
4 7: OBJECT IDENTIFIER ecPublicKey (1 2 840 10045 2 1)
13 8: OBJECT IDENTIFIER prime256v1 (1 2 840 10045 3 1 7)
: }
23 66: BIT STRING
: 04 A0 9D CB 1B C7 39 E7 F1 9A FA 9A DC B1 94 49
: 68 BF BA 73 EF CE C2 9B 50 48 6E B4 4D 1B 29 C1
: 93 44 99 70 A3 73 68 30 CB 2B D5 D7 EC 05 D2 BD

```

```

: 1F C0 7B 6D F5 E4 8B 54 CE 77 A6 A7 22 9C 3A 91
: C2
: }

```

\*\*: The server public key in text representation:

```

0 89: SEQUENCE {
2 19: SEQUENCE {
4 7: OBJECT IDENTIFIER ecPublicKey (1 2 840 10045 2 1)
13 8: OBJECT IDENTIFIER prime256v1 (1 2 840 10045 3 1 7)
: }

23 66: BIT STRING
: 04 82 C7 73 F3 78 D3 0C 27 83 A4 8E B8 11 B9 6C
: F6 A9 06 94 A8 56 4F 1E 7F 6D 36 61 52 F1 16 98
: 95 0F 6F 7C 40 CD A5 85 33 4F 83 77 50 A1 02 F5
: BF 25 50 8C EB 9E 55 DF C0 F1 2A 45 51 99 A4 C9
: 60
: }

```

\*\*\*: The client private key in text representation:

```

0 119: SEQUENCE {
2 1: INTEGER 1
5 32: OCTET STRING
: 9F 35 2D A1 64 95 74 8E 14 6F CB 53 70 B8 E9 6D
: 29 2C ED 55 67 A8 FA E5 5A 22 BB 67 D9 16 51 B8
39 10: [0] {
41 8: OBJECT IDENTIFIER prime256v1 (1 2 840 10045 3 1 7)
: }
51 68: [1] {
53 66: BIT STRING
: 04 A0 9D CB 1B C7 39 E7 F1 9A FA 9A DC B1 94 49
: 68 BF BA 73 EF CE C2 9B 50 48 6E B4 4D 1B 29 C1
: 93 44 99 70 A3 73 68 30 CB 2B D5 D7 EC 05 D2 BD
: 1F C0 7B 6D F5 E4 8B 54 CE 77 A6 A7 22 9C 3A 91
: C2
: }
: }

```

The example above has been created as follows, as illustrated using the Server Public Key resource example. If the hex sequence of the Server Public Key resource is pasted into a text file with the name example.hex. Here is the content of example.hex:

```
'3059301306072a8648ce3d020106082a8648ce3d0301070342000482c773f378d30c2783a48eb811b96cf6a90694a8564f1e7f6d366152f11698950f6f7c40cda585334f837750a102f5bf25508ceb9e55dfcof12a455199a4c960'
```

Then, the hex data needs to be converted into a binary using the Linux xxd command:

```
xxd -r -p example.hex >public-key.pub
```

Finally, the binary needs to be interpreted as a public key using the Linux dumpasn1 command:

```
dumpasn1 public-key.pub
```

Resource Name	Resource ID	Resource Instance ID	Value	Notes
Short Server ID	0		101	Example LwM2M Server 1
Lifetime	1		86400	
Default Minimum Period	2		300	
Default Maximum Period	3		6000	
DisableTimeout	5		86400	
Notification Storing When Disabled or Offline	6		True	
Binding Preference	7		U	UDP binding preference

Table: F.-5 LwM2M Server Object [0]

Resource Name	Resource ID	Resource Instance ID	Value	Notes
Short Server ID	0		102	Example LwM2M Server 2
Lifetime	1		86400	
Default Minimum Period	2		60	
Default Maximum Period	3		6000	
DisableTimeout	5		86400	
Notification Storing When Disabled or Offline	6		False	
Binding Preference	7		U	UDP binding preference

Table: F.-6 LwM2M Server Object [1]

Resource Name	Resource ID	Resource Instance ID	Value	Notes
Object ID	0		1	LwM2M Server Object 0 (Server 1)
Object Instance ID	1		0	
ACL	2	101	ob0000000000001111	For this Object Instance (1:0), Server 1 has access rights (R, W, E, D). Note that the Resource Instance ID indicates the Short Server ID.
Access Control Owner	3		101	Server 1 controls this Object Instance's access rights.

Table: F.-7 Access Control Object [0] (for the LwM2M Server Object Instance 0)

Resource Name	Resource ID	Resource Instance ID	Value	Notes
Object ID	0		1	LwM2M Server Object 1 (Server 2)
Object Instance ID	1		1	
ACL	2	102	ob0000000000001111	For this Object Instance (1:1), Server 2 has access rights (R, W, E, D). Note that the Resource Instance ID indicates the Short Server ID.
Access Control Owner	3		102	Server 2 controls this Object Instance's access rights.

Table: F.-8 Access Control Object [1] (for the LwM2M Server Object Instance 1)

Resource Name	Resource ID	Resource Instance ID	Value	Notes
Object ID	0		3	Device Object
Object Instance ID	1		0	
ACL	2	101	ob0000000000001111	For this Object Instance (3:0), Server 1 has access rights (R, W, E, D). Note that the Resource Instance ID indicates the Short Server ID.
ACL	2	102	ob0000000000000001	For this Object Instance (3:0), Server 2 has read-only access rights. Note that the Resource Instance ID indicates the Short Server ID.
Access Control Owner	3		101	Server 1 controls this Object Instance's access rights.

Table: F.-9 Access Control Object [2] (for the Device Object Instance)

Resource Name	Resource ID	Resource Instance ID	Value	Notes
Object ID	0		4	Connectivity Monitoring Object
Object Instance ID	1		0	
ACL	2	101	ob0000000000000001	For this Object Instance (4:0), Server 1 has read-only access rights. Note that the Resource Instance ID indicates the Short Server ID.
ACL	2	0	ob0000000000000001	For this Object Instance (4:0), The other Servers except Server 1 have read-only access rights. Note that this Resource Instance ID indicates the default access rights.
Access Control Owner	3		101	Server 1 controls this Object Instance's access rights.

Table: F.-10 Access Control Object [3] (for the Connectivity Monitoring Object Instance)

Resource Name	Resource ID	Resource Instance ID	Value	Notes
Object ID	0		5	Firmware Update Object
Object Instance ID	1		65535	Irrelevant

ACL	2	101	0b000000000010000	Server 1 can create Firmware Update Object Instance
Access Control Owner	3		65535	This Object Instance must be managed by Bootstrap Interface

Table: F.-11 Access Control Object [4] (for the Firmware Update Object)

Resource Name	Resource ID	Resource Instance ID	Value	Notes
Manufacturer	0		Open Mobile Alliance	
Model Number	1		Lightweight M2M Client	
Serial Number	2		345000123	
Firmware version	3		1.0	
Available Power Sources	6	0	1	Internal Battery
Available Power Sources	6	1	5	USB
Power Source Voltage	7	0	3800	3.8V battery
Power Source Voltage	7	1	5000	USB VBUS
Power Source Current	8	0	125	125mA
Power Source Current	8	1	900	USB 900mA
Battery level	9		100	
Memory free	10		15	15 kB of free memory
Error code	11	0	0	No errors
Current Time	13		1367491215	May 2 <sup>nd</sup> , 2013 at 11:42 AM GMT
UTC Offset	14		+02:00	UTC+2 (CET)
Supported Binding and Modes	16		U	UDP binding

Table: F.-12 Device Object Instance

Resource Name	Resource ID	Resource Instance ID	Value	Notes
Network Bearer	0		0	GSM Bearer
Available Network Bearer	1		0	GSM Bearer
Radio signal strength	2		92	RSSI in dBm
3		2	RxQual Downlink	
IP Addresses	4	0	192.168.0.100	
Router IP Addresses	5	0	192.168.1.1	
Link Utilization	6		5	%
APN	7	0	internet	

Table: F.-13 Connectivity Monitoring Object Instance

## Appendix G. Storage of LwM2M Bootstrap Information on the Smartcard (Normative)

This appendix aims at specifying the storage of the LwM2M Bootstrap Information in a PKCS#15 file structure within an UICC Smartcard platform [ETSI 102 221].

### G.1 File structure

The information format is based on [PKCS#15] specification. The Bootstrap data is located under the PKCS#15 directory allowing the card issuer to decide the identifiers and the file locations.

The [PKCS#15] specification defines a set of files.

```
MF (3F00)
|-EF DIR (2F00) --> reference PKCS\#15 Application & DF PKCS\#15
|-DF PKCS-15
|-ODF      --> ref to DODF      (Default:5031)
|-DODF     --> ref EF LwM2M Bootstrap (Default:6030)
|-EF LwM2M Bootstrap --> Contains LwM2M Bootstrap Data
```

Within the PKCS#15 application, the starting point to access the PKCS#15 files is the Object Directory File (ODF). The EF (ODF) contains pointers to other files, each one containing a directory over PKCS#15 objects of a particular class. (authentication objects, data objects, keys, certificates...). For the purpose of LwM2M Bootstrap capability, the EF(ODF) MUST contain an EF Record describing a DODF(Data Object Directory Files) in which is found the reference pointing to the LwM2M Bootstrap data.

- The EF (ODF) is described in [G.3.2 Object Directory File, EF\(ODF\)](#) and [PKCS#15].
- The EF (DODF-bootstrap) is described in [G.3.3 Data Object Directory File, EF\(DODF-bootstrap\)](#) and [PKCS#15].
- The EF (LwM2M Bootstrap data) is described in [G.3.4 EF \(LwM2M Bootstrap\)](#).

### G.2 Bootstrap Information on UICC

#### G.2.1 Access to the file structure

The selection of the PKCS#15 file structure or application is not within the scope of the specification and can be managed in different ways by the devices (Direct File Access using PKCS#15 AID , Indirect Access using EF Dir information).

However, the following sequence is a recommended way to perform the selection of the PKCS#15 application:

1. With only one PKCS#15 application present in the UICC, the device may send a SELECT command with the PKCS#15 AID (A0 00 00 00 63 50 4B 43 53 2D 31 35) as parameter (Direct Access). If the selection is successful, the device can start reading PKCS#15 files (ODF, DODF ..).
2. If the previous selection fails (or if it might have several PKCS#15 applications present in UICC), the device sends SELECT commands to access EFdir to locate an entry with the PKCS#15 AID. If only one matching entry is found, the device MUST select the PKCS#15 DF path from that entry, and then can start reading PKCS#15 files (ODF, DODF...). If several entries are matching, the device MUST look for the entry containing the OID related to LwM2M "2.23.43.9" see [G.3 Files Description](#) and MUST then select the associated DODF where it will find the path for the searched EF(LwM2M Bootstrap).

#### G.2.2 Files Overview (example)

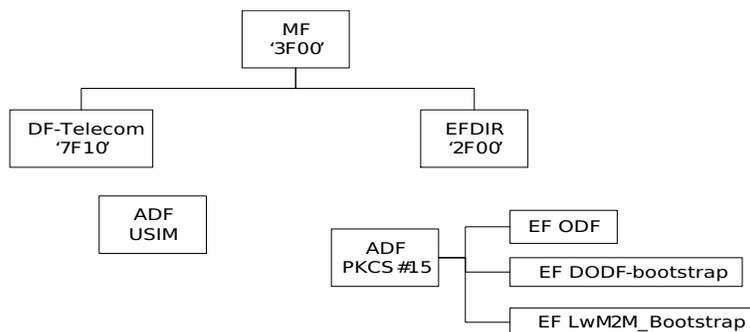

Figure: G.2.2-1 Example of a UICC File Structure embedding a specific PKCS#15 file structure containing LwM2M Bootstrap data location

### G.2.3 Access Method

UICC Commands Read Binary and Update Binary, as defined in [ETSI 102 221], are used to access bootstrap data.

### G.2.4 Access Conditions

The Device is informed of the access conditions of provisioning files by evaluating the “private” and “modifiable” flags in the corresponding DODF-bootstrap files structure [PKCS#15].

For the M2M context, the flags mentioned above can be unset to prevent cardholder verification step through pin code. When more control is needed, the Secure Channel SHOULD be used [Appendix H. Secure channel between Smartcard and LwM2M Device Storage for secure Bootstrap Data provisioning \(Normative\)](#).

### G.2.5 Requirements on the Device

To retrieve the Bootstrap Information from the UICC, the Device MUST perform the following steps:

- Select PKCS#15 file structure as recommended in [G.2.1 Access to the file structure](#).
- if needed (single PKCS#15 application case) Read EF(ODF) to locate the EF(DODF-bootstrap),
- Read EF(DODF) and look for the OMA-LwM2M OID to locate the file containing the LwM2M\_Bootstrap data,
- Read the LwM2M\_Bootstrap file

## G.3 Files Description

All PKCS#15 files defined, are binary files as specified in [ETSI 102 221] and encoded in DER Format [PKCS#15]. These files are read and updated using UICC Commands related to the application they belong to.

### G.3.1 EF(DIR) – optional

When the optional EF (DIR) is used to locate the PKCS#15 files structure, one of its logical record MUST be of the following ASN.1 type with the specified [PKCS#15] tags :

- Application template Tag 0x61
- Application Identifier Tag 0x4F
- Path Tag 0x51
- Application label Tag 0x50
- data Object Tag 0x73 (Multiple PKCS#15 Application case)

```

DIREcord ::= [APPLICATION 1] SEQUENCE {
  aid [APPLICATION 15] OCTET STRING,
  label [APPLICATION 16] UTF8STRING OPTIONAL
  path [APPLICATION 17] OCTET STRING
  ddo [APPLICATION 19] DDO OPTIONAL // used in multiple PKCS#15 Applications case and containing
  // OID & associated DODF path (see [Requirements on the Device]() & \[PKCS#15\])

```

}

Coding example :

aid PKCS#15 = A0 00 00 00 63 50 4B 43 53 2D 31 35 (Tag : 0x4F)

label = "BOOTSTRAP" (Tag : 0x50)

path = 3F00/7F50 (Tag : 0x51)

61 22

4F 0C A0 00 00 00 63 50 4B 43 53 2D 31 35

50 08 42 4F 4F 54 53 54 52 41 50

51 04 3F 00 7F 50

### G.3.2 Object Directory File, EF(ODF)

The mandatory Object Directory File (ODF) ([PKCS#15], Section 5.5.1) contains pointers to other EFs, each one containing a directory of PKCS#15 objects of a particular class (Keys, Authentication, Data ..). The EF(ODF) File ID is specified in [PKCS#15](0x5031). The card issuer decides the file size. The EF (ODF) can be read but it MUST NOT be modifiable by the user.

The EF (ODF) is described below:

Identifier: default 0x5031, see [PKCS#15]	Structure: Binary	Mandatory
File size: decided by the card issuer	Update activity: low	
Access Conditions: READ ALW UPDATE ADM INVALIDATE ADM REHABILITATE ADM		
Description : Binary coding example (DER format) A7 06 30 04 04 02 64 30 (reference DODF = 0x6430)		
See [PKCS#15]		

Table: G.3.2-1 Object Directory File, EF ODF

### G.3.3 Data Object Directory File, EF(DODF-bootstrap)

This Data Object Directory File used as the entry point to the LwM2M Bootstrap data, MUST contains an oidDO entry [PKCS#15] with an OID that MUST be in the OMA-LwM2M scope.

The registered OID for this specification is: {joint-isu-itu-t(2) international-organizations(23) oma(43) oma-lwm2m(9) lwm2m\_bootstrap(1)} (2.23.43.9.1).

According to [PKCS#15], the DODF MUST include a DataType with the oidDO entry. The DataType oidDO entry is defined as PKCS15Object {CommonDataObjectAttributes, NULL, OidDO}.

- The CommonDataObjectAttributes structure of the DODF DataType oidDO entry MAY contain an applicationName or an applicationOID. The applicationName and the applicationOID are informative in this specification (may be omitted).
- The OidDO structure of the DODF DataType oidDO entry MUST be present and MUST contain an id value set to the registered OID defined above and a value that is a path structure to the EF (LwM2M Bootstrap data).

This path structure is defined with the following ASN.1 syntax [PKCS#15]: Path ::= SEQUENCE { path OCTET STRING, index INTEGER (0..65535) OPTIONAL, length [0] INTEGER (0..65535) OPTIONAL } ( WITH COMPONENTS { ..., index PRESENT, length PRESENT } | WITH COMPONENTS { ..., index ABSENT, length ABSENT }) with "path" being the path to the EF (LwM2M Bootstrap data)

The File ID is described in the EF (ODF). The file size depends on the number of provisioning objects stored in the smartcard. Thus, the card issuer decides the file size.

Identifier: 0x6430, See ODF	Structure: Binary	Mandatory
File size: decided by the card issuer	Update activity: low	
Access Conditions: READ ALW or Universal / application / Local PIN (UICC, See <a href="#">G.2 Bootstrap Information on UICC</a> ) UPDATE ADM INVALIDATE ADM REHABILITATE ADM		
Description : : Binary coding example (DER format) Label = "LwM2M Bootstrap" HEX : 4C774D324D20426F6F747374726170 OID OMA-LwM2M Bootstrap "2.23.43.9.1" (HEX DER) 06 04 67 2B 09 01 Path = 0x6432 A1 25 30 00 30 11 0C 0F 4C 77 4D 32 4D 20 42 6F 6F 74 73 74 72 61 70 A1 0E 30 0C 06 04 67 2B 09 01 30 04 04 02 64 32		
See hereafter and [PKCS#15]		

Table: G.3.3-1 Bootstrap Data Object Directory File, EF DODF-bootstrap

### G.3.4 EF (LwM2M\_Bootstrap)

Only the card issuer can modify EF LwM2M\_Bootstrap

Identifier: See DODF	Structure: Binary	Optional
File size: decided by the card issuer	Update activity: low	
Access Conditions: READ ALW or Universal / application / Local PIN (UICC, See <a href="#">G.2 Bootstrap Information on UICC</a> ) UPDATE ADM INVALIDATE ADM REHABILITATE ADM		
Description		
Contains Bootstrap data (encapsulated LwM2M Objects)		

Table: G.3.4-1 EF LwM2M\_Bootstrap

This file size is limited to 32KB; the effective file size, in Bytes, is accessible from the File header.

In this file, the Bootstrap data relies on LwM2M TLV Data format specification.

The LwM2M specification already describes the TLV format for coding multiples instances and Resources of a given Object ([7.5.5. TLV](#)), this section will only detailed how to store a collection of LwM2M Objects in this EF LwM2M\_Bootstrap file; each Object is coded with a header containing a LwM2M Object ID and its Object Version coded in one or 2 Bytes, a LwM2M-TLV coding the Object Instances as payload, and a length being the size in bytes of this payload (LwM2M-TLV of the Object Instances). Data are represented in network byte order (big endian).

Additionally, this Bootstrap data will have a 2 Byte header indicating the number of Objects contained in that file and another 2 Bytes for indicating the size of the full payload (size of the collection of LwM2M Objects).

Using a BNF-like description:

```
<bootstrap_data> ::= <number of objects> <size> <collection_of_lwm2m_objects>
<number of Objects> ::= HWORD
<size> ::= HWORD
<collection_of_lwm2m_objects> ::= <single_lwm2m_object>*
<single_lwm2m_object> ::= <lwm2m_object_ID> <object_version> <length_of_object> <lwm2m_object_instances>
<lwm2m_object_ID> ::= HWORD
```

<object\_version> ::= IMPLICIT\_VERSION | <other\_version>

<other\_version> ::= MAJOR\_VERSION MINOR\_VERSION ; value %x0205 means version 2.5

<length\_of\_object> ::= HWORD

<lwm2m\_object\_instances> ::= TLV data format as described in [7.5.5.TLV](#)

HWORD ::= %x00-FFFF

IMPLICIT\_VERSION ::= %x00 ; means version 1.0 or the Object is defined in the LwM2M Enabler

MAJOR\_VERSION ::= %x01-FF

MINOR\_VERSION ::= %x00-FF

In reading and processing the data of this file, the LwM2M Client is then able to be configured with the Bootstrap Information and thus to access the LwM2M Server(s).

## Appendix H. Secure channel between Smartcard and LwM2M Device Storage for secure Bootstrap Data provisioning (Normative)

During LwM2M Bootstrap procedure, sensitive data have to be provisioned in LwM2M Device.

When Bootstrap information comes from Smartcard, a Secure Channel SHOULD be established between the Smartcard and the LwM2M Client. When required this Secure Channel MUST follow the following recommendations provided by [GLOBALPLATFORM] which are illustrated below. The Bootstrap information will be retrieved from Smartcard as described in [Appendix F. Example LwM2M Client \(Informative\)](#) of this document with the modification the usage of introducing a secured transfer between the Smartcard and the Device: instead of using PKCS#15 application, a specific OMA-LwM2M Bootstrap application MUST be selected in the Smartcard (SELECT command). The File Structure where the LwM2M Bootstrap Data is located, MUST only be accessible if the Mutual Authentication of the [GLOBALPLATFORM] process has been satisfied.

The AID (0xA00000041200020000000000) of the OMA-LwM2M Bootstrap Application is composed of the OMA RID code (0xA000000412), and the OMA PIX code containing the LwM2M Application code (0x0002) and a specific code used by the application; this specific code is relative to the Bootstrap data retrieval (00 00 00 00 00)

Pre-requisite: the Smartcard and the LwM2M device have to share the same static Keys KEY\_ENC, KEY\_MAC, KEY\_DEK as specified in [GLOBALPLATFORM].

These keys are provisioned in the Devices in using out-of-band methods.

The steps for the secured transfer are the following and are illustrated below [Figure: H.-1 Bootstrap Information transfer from Smartcard to LwM2M Device using Secure Channel according to \[GLOBALPLATFORM\]](#):

- The OMA-LwM2M Bootstrap application used for transferring the Bootstrap information is selected
- Secure Channel (mutual authentication) is established
- PKCS#15 flow as described in [Appendix F. Example LwM2M Client \(Informative\)](#) takes place for selecting and transferring the Bootstrap file from Smartcard to the Device: the sensitive Bootstrap data are transferred encrypted using the [GLOBALPLATFORM] Secure Channel. When the Mutual Authentication is not satisfied, access to the file structure will return an error code 6982 to the Device (Security status not satisfied).

As a general recommendation, in the process for retrieving the Bootstrap data from the Smartcard, the Device SHOULD firstly try to select the OMA-LwM2M Bootstrap application to activate the [GLOBALPLATFORM] Secure Channel procedure; if such an application is not present, the Device SHOULD then try to get this Bootstrap Data by selecting the PCKS#15 application as described in [Appendix G. Storage of LwM2M Bootstrap Information on the Smartcard \(Normative\)](#).

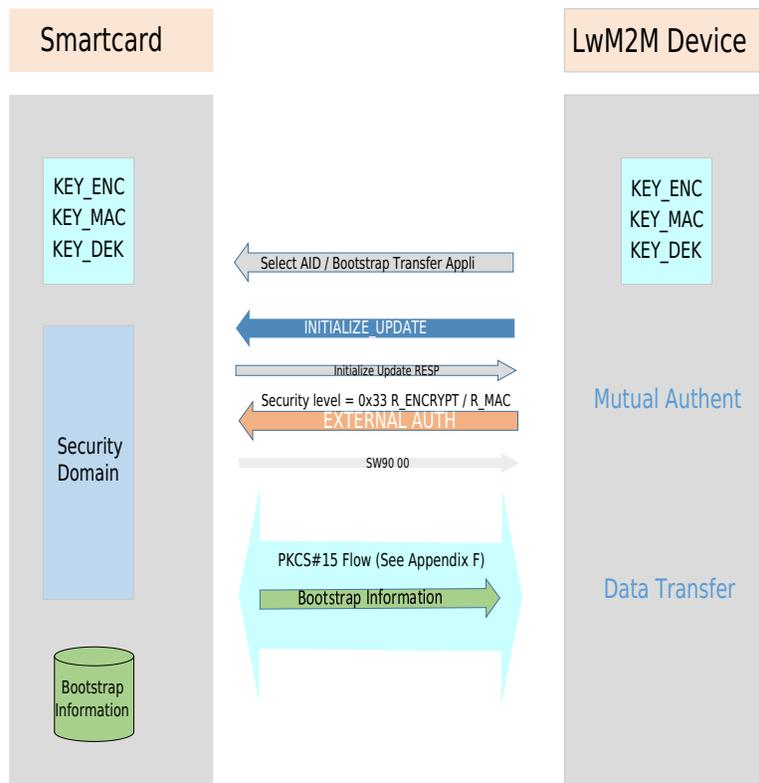

Figure: H.-1 Bootstrap Information transfer from Smartcard to LwM2M Device using Secure Channel according to [GLOBALPLATFORM]

The OMA-LwM2M Bootstrap application (AID : (0xA00000041200020000000000)) MUST support the following commands : As specified in [GLOBALPLATFORM]:

- INITIALIZE UPDATE
- EXTERNAL AUTHENTICATE with P1=0x33 (C-DECRYPTION, R-ENCRYPTION, C-MAC and R-MAC)

As defined in [ETSI 102 221]:

- SELECT with P1=0x00 (select by file ID)
- READ BINARY Any other command is optional.

## I Media Types (Normative)

### I.1 Media-Type application/vnd.oma.lwm2m+tlv Registration

application/vnd.oma.lwm2m+tlv has been registered with IANA in version 1.0.

### I.2 Media-Type application/vnd.oma.lwm2m+json Registration

application/vnd.oma.lwm2m+json has been registered with IANA in version 1.0.

### I.3 Media-Type application/vnd.oma.lwm2m+cbor Registration

This section contains the IANA registration for media-type application/vnd.oma.lwm2m+cbor (see <http://www.iana.org/assignments/media-types/media-types.xhtml>).

Type name: application

Subtype name: vnd.oma.lwm2m+cbor

Required parameters: none

Optional parameters: none

Encoding considerations: binary

Security considerations:

OMA LwM2M data is passive, meaning it does not contain executable or active content which may represent a security threat. The OMA LwM2M CBOR format does not contain fields which are confidential. The usage of the LwM2M CBOR format may be vulnerable to attacks modifying or spoofing the content of this format. The OMA LwM2M protocol uses source authentication and integrity protection.

This media type inherits the security issues associated with the CBOR format.

Interoperability considerations:

This content type carries OMA LwM2M data model serialization within the scope of the OMA LwM2M enabler. The OMA LwM2M enabler specification includes static conformance requirements for this content.

Published specification:

OMA LwM2M 1.2 Technical Specification. Available from <http://www.openmobilealliance.org>

Applications, which use this media type:

OMA LwM2M

Fragment identifier considerations: none

Additional information:

- Deprecated alias names for this type: none
- Magic number(s): none
- File extension(s): none
- Macintosh File Type Code(s): none

Intended usage: Limited use. Only for usage with OMA LwM2M, which meet the semantics given in the mentioned specification.

Restriction on usage: no

Person & email address to contact for further information:

John Mudge

[helpdesk@omaorg.org](mailto:helpdesk@omaorg.org)

Author/Change controller:

Open Mobile Naming Authority (OMNA)

[OMA-OMNA@mail.openmobilealliance.org](mailto:OMA-OMNA@mail.openmobilealliance.org)

Provisional registration (standards tree only): N/A

## Appendix J. LwM2M Schema and Object Definition File (Informative)

For supporting the LwM2M Enabler version and the Object Version in the Definition file (.xml) of a LwM2M Object, the LwM2M schema (URL: = "<http://openmobilealliance.org/tech/profiles/LWM2M.xsd>") contains 2 optional elements: LwM2MVersion and ObjectVersion, see [LwM2M Schema](#).

The Object definition file (.xml), which describes the resources of a particular Object may contain these two elements:

1. the "LwM2MVersion" element indicates the minimum version of the LwM2M Enabler supporting that Object,
2. the "ObjectVersion" element indicates the version of the Object as defined in Section [7.2. Object Versioning](#) of this document.

In addition:

- when the minimum LwM2M version supporting the Object is the Initial Version of the LwM2M Enabler (1.0), this information may be omitted.
- when the Object version is the Initial Version of that Object (1.0), the Object Version information may be omitted.
- when the Object definition is part of any LwM2M Enabler, the Object Version information may be omitted.

For example: an Object ID:44 in Version 2.4 for which the minimum LwM2M version supporting this Object Version is 1.1, will have an URN defined as "*urn:oma:lwm2m:oma:44:2.4*" used to name the associate Object definition (.xml) file on the [OMNA](#) portal:

```
<?xml version="1.0" encoding="UTF-8"?>
<LWM2M xmlns:xsi = "http://www.w3.org/2001/XMLSchema-instance" xsi:noNamespaceSchemaLocation="http://openmobilealliance.org/tech/profiles/LWM2M.xsd" >
  <Object ObjectType="MODefinition">
    <Name>MyDevice</Name>
    <Description1><![CDATA[This LWM2M Object is my device]]></Description1>
    <ObjectID>44</ObjectID>
    <LWM2MVersion>1.1</LWM2MVersion>
    <ObjectVersion>2.4</ObjectVersion>
    <ObjectURN>urn:oma:lwm2m:oma:44:2.4</ObjectURN>
    <MultipleInstances>Single</MultipleInstances>
    <Mandatory>Mandatory</Mandatory>
    <Resources>
      .
    </Resources>
    </Description2>
    </Resources>
  </Object>
</LWM2M>
```

## Appendix K. LwM2M Schema (Normative)

This appendix provides the content of the LightweightM2M schema.

The schema was created to support the [LwM2M Editor Tool](#). The following elements and attributes are used by the [LwM2M Editor Tool](#) but are not part of the LwM2M protocol:

- Description1, it is used to insert the definition of the Object
- Description2, it is used to insert any extra information at the end of the table that contains the Resources
- ObjectType, used to identify if the file contains an Object and Resources or only Resources

The content of the schema is displayed below:

0 No commit found for the ref v1\_2-dev

## Appendix L. Example of Trigger Message from Server (Informative)

Example WAP Push over SMS containing the trigger information:

Binary value	Meaning	Description
06	User-Data-Header (UDHL) Length = 6 bytes	WDP layer (start WDP headers).
05	UDH IE identifier: Port numbers	
04	UDH port number IE length	
0B	Destination port (high)	Port number 2948
84	Destination port (low)	
C0	Originating port (high)	Port number chosen by sender
02	Originating port (low)	WDP layer (end WDP headers)
01	Transaction ID / Push ID	WSP layer (start WSP headers)
06	PDU type (push)	
03	Headerslength (content type+headers)	
C4	Content type code	MIME-Type
AF	X-WAP-Application-ID	
9A	Id for urn: x-wap-application:lwm2m.dm	WSP layer (end WSP headers)
{14-bytes}	112-bit clear value	Clear CoAP Text

Table: L.-1 Example WAP Push over SMS containing the trigger information

CoAP raw bytes	Description
44 02 b6 0b 21 61 fb 63 b1 31 01 30 01 38	PDU length: 14 CoAP Version: 1 Message Type: Confirmable Token length: 4 Code: 0.02 POST Message ID: 34488 Token length: 4 Value: 0x301e65ca  OPTION (0/3) Option number (delta): 11(11) Name: URI_PATH Value length: 1 Value: "1"  OPTION (1/3) Option number (delta): 11(0) Name: URI_PATH Value length: 1 Value: "0"  OPTION (2/3) Option number (delta): 11(0) Name: URI_PATH Value length: 1 Value: "8" No payload.

Table: L.-2 Example WAP Push over SMS containing the trigger information

## Appendix M. SenML CBOR Example (Informative)

The example request to Device Object of the LwM2M example client (Read /3/0) is shown below using the SenML CBOR format with comments.

```

90      # array(16)
A3      # map(3)
  21     # negative(1)
  65     # text(5)
    2F332F302F      # "/3/0/"
  00     # unsigned(0)
  61     # text(1)
    30             # "0"
  03     # unsigned(3)
  74     # text(20)
    4F70656E204D6F62696C6520416C6C69616E6365 # "Open Mobile Alliance"
A2      # map(2)
  00     # unsigned(0)
  61     # text(1)
    31             # "1"
  03     # unsigned(3)
  76     # text(22)
    4C69676874776569676874204D324D20436C69656E74 # "Lightweight M2M Client"
A2      # map(2)
  00     # unsigned(0)
  61     # text(1)
    32             # "2"
  03     # unsigned(3)
  69     # text(9)
    333435303030313233 # "345000123"
A2      # map(2)
  00     # unsigned(0)
  61     # text(1)
    33             # "3"
  03     # unsigned(3)
  63     # text(3)
    312E30          # "1.0"
A2      # map(2)
  00     # unsigned(0)
  63     # text(3)
    362F30          # "6/0"
  02     # unsigned(2)
  01     # unsigned(1)
A2      # map(2)
  00     # unsigned(0)
  63     # text(3)
    362F31          # "6/1"
  02     # unsigned(2)
  05     # unsigned(5)
A2      # map(2)
  00     # unsigned(0)
  63     # text(3)
    372F30          # "7/0"
  02     # unsigned(2)
  19 0ED8          # unsigned(3800)
A2      # map(2)
  00     # unsigned(0)
  63     # text(3)
    372F31          # "7/1"
  02     # unsigned(2)
  19 1388          # unsigned(5000)
A2      # map(2)
  00     # unsigned(0)
  63     # text(3)

```

```
382F30      # "8/0"
02          # unsigned(2)
18 7D      # unsigned(125)
A2         # map(2)
00         # unsigned(0)
63         # text(3)
  382F31   # "8/1"
02         # unsigned(2)
19 0384    # unsigned(900)
A2         # map(2)
00         # unsigned(0)
61         # text(1)
  39       # "9"
02         # unsigned(2)
18 64      # unsigned(100)
A2         # map(2)
00         # unsigned(0)
62         # text(2)
  3130     # "10"
02         # unsigned(2)
0F         # unsigned(15)
A2         # map(2)
00         # unsigned(0)
64         # text(4)
  31312F30 # "11/0"
02         # unsigned(2)
00         # unsigned(0)
A2         # map(2)
00         # unsigned(0)
62         # text(2)
  3133     # "13"
02         # unsigned(2)
1A 5182428F # unsigned(1367491215)
A2         # map(2)
00         # unsigned(0)
62         # text(2)
  3134     # "14"
03         # unsigned(3)
66         # text(6)
  2B30323A3030 # "+02:00"
A2         # map(2)
00         # unsigned(0)
62         # text(2)
  3136     # "16"
03         # unsigned(3)
61         # text(1)
55         # "U"
```